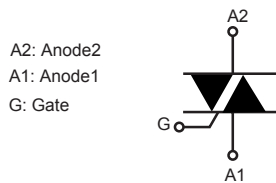
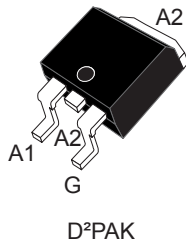

16 A - 800 V logic level T-series Triac in D²PAK

Product status link

[T1610T-8G](#)

Product summary

$I_{T(RMS)}$	16 A
V_{DRM}/V_{RRM}	800 V
V_{DSM}/V_{RSM}	900 V
I_{GT}	10 mA

Features

- 150 °C maximum junction temperature
- Three quadrants
- High commutation on resistive loads
- Surge capability V_{DSM} , $V_{RSM} = 900$ V
- Benefits:
 - Easy direct control by MCU thanks to low 10 mA I_{GT}
 - Increase of thermal margin due to extended working T_j up to 150 °C

Applications

- General purpose AC line load switching
- Small home appliances with resistive loads
- Hybrid relays
- Inrush current limiting circuits
- Overvoltage crowbar protection

Description

The SMD T1610T-8G Triac can be used for the on/off or phase angle control function in general purpose AC switching with resistive loads. A Logic level T-series Triac, the T1610T-8G can be controlled directly from an MCU with a simplified circuit. T-series triacs are optimized for high EMI constraints.

The surface mount D²PAK package enables compact SMT designs for automated manufacturing.

D²PAK package's molding compound resin is halogen-free and meets UL94 flammability standard level V0.

Package environmentally friendly [Ecopack2](#) graded (RoHS and Halogen Free compliance).

1 Characteristics

Table 1. Absolute maximum ratings (limiting values), $T_j = 25\text{ °C}$ unless otherwise specified

Symbol	Parameter	Value	Unit	
V_{DRM}/V_{RRM}	Repetitive peak off-state voltage (50-60 Hz)	$T_j = 125\text{ °C}$	800	V
		$T_j = 150\text{ °C}$	600	V
V_{DSM}/V_{RSM}	Non Repetitive peak off-state voltage	$t_p = 10\text{ ms}, T_j = 25\text{ °C}$	900	V
$I_{T(RMS)}$	RMS on-state current (full sine wave)	$T_c = 126\text{ °C}$	16	A
I_{TSM}	Non repetitive surge peak on-state current (full cycle, T_j initial = 25 °C)	$t = 16.7\text{ ms}$	126	A
		$t = 20\text{ ms}$	120	
I^2t	I^2t value for fusing	$t_p = 10\text{ ms}$	95	A^2s
di/dt	Critical rate of rise of on-state current, $I_G = 2 \times I_{GT}$, $t_r \leq 100\text{ ns}$	$f = 100\text{ Hz}$	100	$A/\mu s$
I_{GM}	Peak gate current	$t_p = 20\text{ }\mu s, T_j = 150\text{ °C}$	4	A
V_{GM}	Peak Gate Voltage		5	V
$P_{G(AV)}$	Average gate power dissipation	$T_j = 150\text{ °C}$	1	W
T_{stg}	Storage junction temperature range		-40 to +150	$^{\circ}C$
T_j	Operating junction temperature range		-40 to +150	$^{\circ}C$

Table 2. Electrical characteristics ($T_j = 25\text{ °C}$, unless otherwise specified)

Symbol	Test conditions	Quadrants; T_j	Value	Unit	
$I_{GT}^{(1)}$	$V_D = 12\text{ V}, R_L = 30\text{ }\Omega$	I - II - III	Max. 10	mA	
V_{GT}	$V_D = 12\text{ V}, R_L = 30\text{ }\Omega$	I - II - III	Max. 1.3	V	
V_{GD}	$V_D = 800\text{ V}, R_L = 3.3\text{ k}\Omega$ $T_j = 125\text{ °C}$	I - II - III	Min. 0.2	V	
I_L	$I_G = 1.2 \times I_{GT}$	I - III	Max. 20	mA	
	$I_G = 1.2 \times I_{GT}$	II	Max. 30	mA	
$I_H^{(2)}$	$I_T = 500\text{ mA}$, gate open		Max. 25	mA	
$dV/dt^{(2)}$	$V_D = 536\text{ V}$, gate open	$T_j = 125\text{ °C}$	Min. 100	$V/\mu s$	
	$V_D = 402\text{ V}$, gate open	$T_j = 150\text{ °C}$	Min. 50	$V/\mu s$	
$(di/dt)^{(2)}$	$(dV/dt)_c = 0.1\text{ V}/\mu s$	$T_j = 125\text{ °C}$	Min.	9	A/ms
		$T_j = 150\text{ °C}$		5.4	
	$(dV/dt)_c = 10\text{ V}/\mu s$	$T_j = 125\text{ °C}$	Min.	3	A/ms
		$T_j = 150\text{ °C}$		1.8	

1. Minimum I_{GT} is guaranteed at 5% of I_{GT} max
2. For both polarities of A2 referenced to A1.

Table 3. Static characteristics

Symbol	Test conditions	T_j		Value	Unit
$V_{TM}^{(1)}$	$I_T = 22.6 \text{ A}$, $t_p = 380 \mu\text{s}$	25 °C	Max.	1.55	V
$V_{TO}^{(1)}$	Threshold on-state voltage	150 °C	Max.	0.85	V
$R_D^{(1)}$	Dynamic resistance	150 °C	Max.	34	mΩ
I_{DRM}/I_{RRM}	$V_{DRM} = V_{RRM} = 800 \text{ V}$	25 °C	Max.	5	μA
		125 °C		1.0	mA
	$V_{DRM} = V_{RRM} = 600 \text{ V}$	150 °C	Max.	3.6	mA

1. For both polarities of A2 referenced to A1.

Table 4. Thermal resistance

Symbol	Parameter			Value	Unit
$R_{th(j-c)}$	Junction to case (AC)	D ² PAK	Max.	1.15	°C/W
$R_{th(j-a)}$	Junction to ambient ($S_{CU}^{(1)} = 2 \text{ cm}^2$)		Typ.	45	°C/W

1. S_{cu} : copper pad surface under tab, 35 μm copper thickness on FR4 PCB.

1.1 Characteristics (curves)

Figure 1. Maximum power dissipation versus on-state RMS current

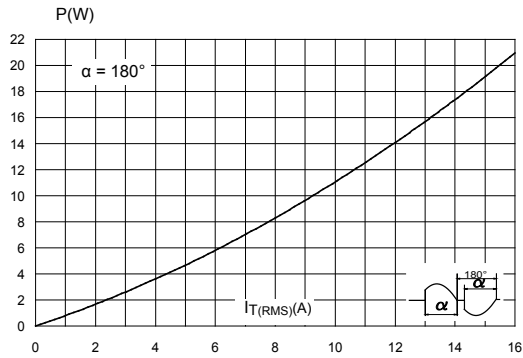

Figure 2. On-state RMS current versus case temperature

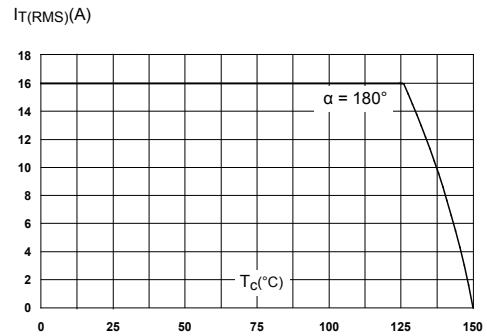

Figure 3. On-state RMS current versus ambient temperature (free air convection)

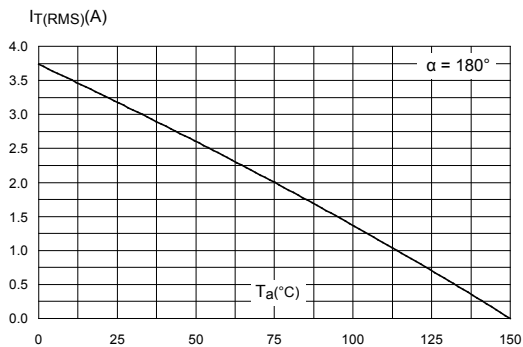

Figure 4. Relative variation of thermal impedance versus pulse duration

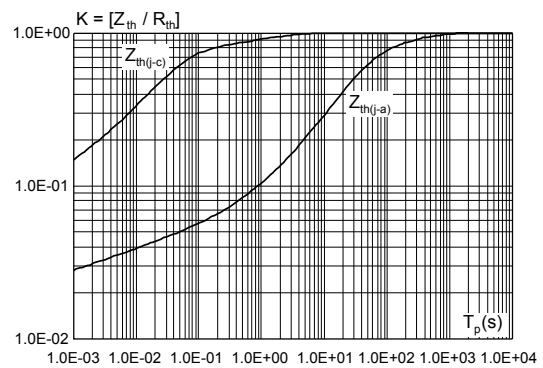

Figure 5. Relative variation of gate trigger voltage and current versus junction temperature (typical values)

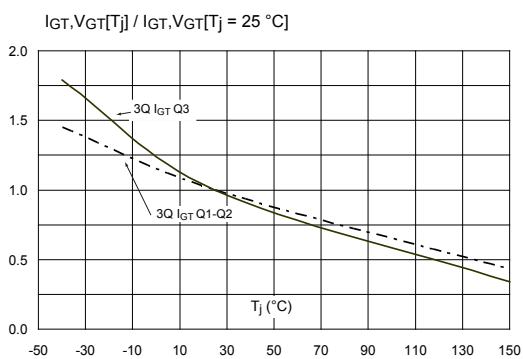

Figure 6. Relative variation of holding current and latching current versus junction temperature (typical values)

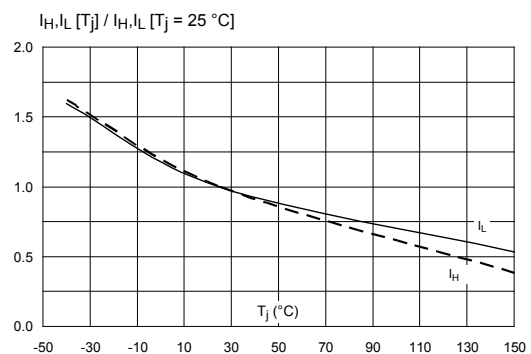

Figure 7. Surge peak on-state current versus number of cycles

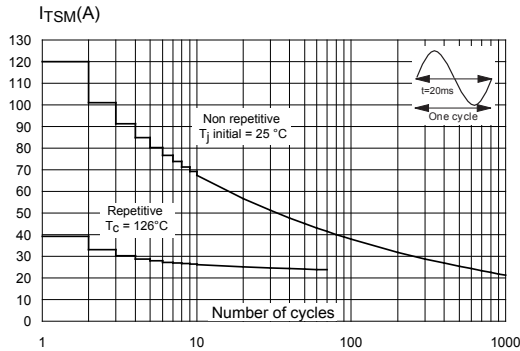

Figure 8. Non repetitive surge peak on-state current for a sinusoidal pulse with width $t_p < 10\text{ ms}$

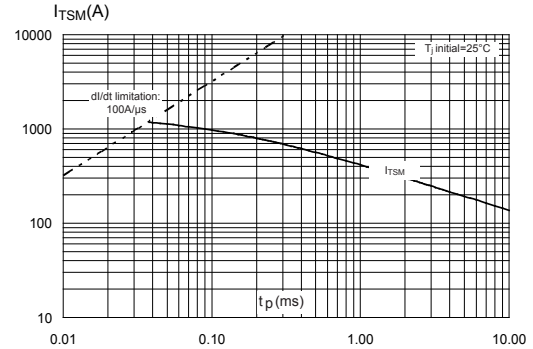

Figure 9. Relative variation of critical rate of decrease of main current versus junction temperature (typical values)

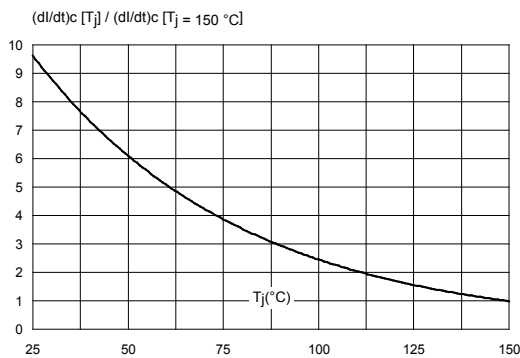

Figure 10. Relative variation of critical rate of decrease of main voltage versus junction temperature

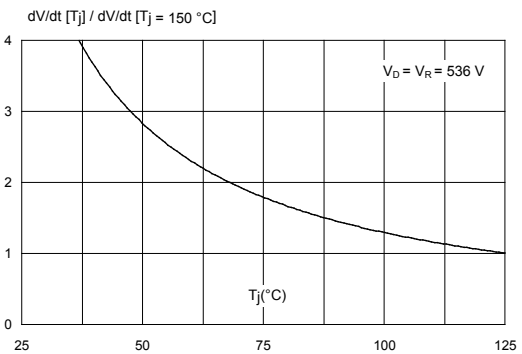

Figure 11. On-state characteristics (maximum values)

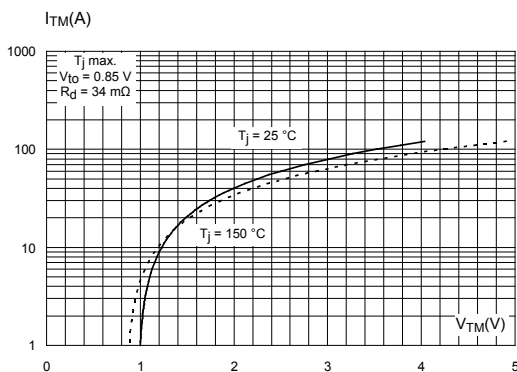

Figure 12. Relative variation of leakage current versus junction temperature for different values of blocking voltage

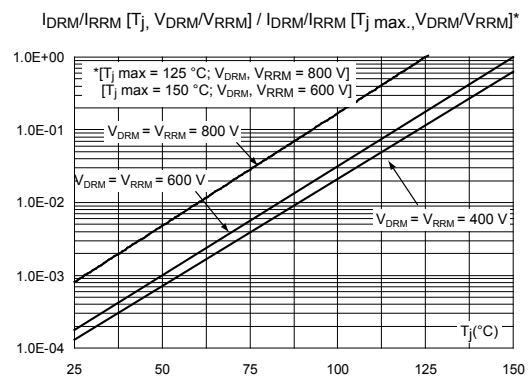
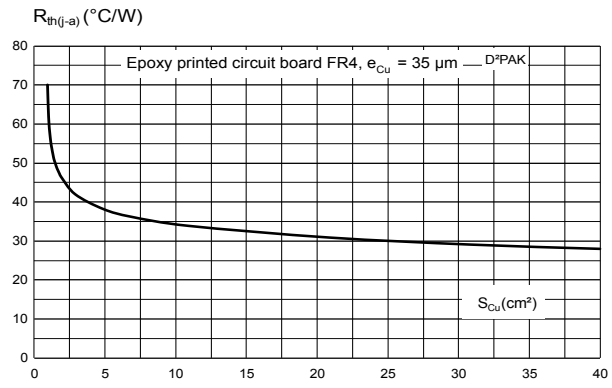

Figure 13. Thermal resistance junction to ambient versus copper surface under tab



2 Package information

In order to meet environmental requirements, ST offers these devices in different grades of **ECOPACK** packages, depending on their level of environmental compliance. ECOPACK specifications, grade definitions and product status are available at: www.st.com. ECOPACK is an ST trademark.

2.1 D²PAK package information

- ECOPACK2 compliant
- Lead-free package leads finishing
- Molding compound resin is halogen-free and meets UL standard level V0

Figure 14. D²PAK package outline

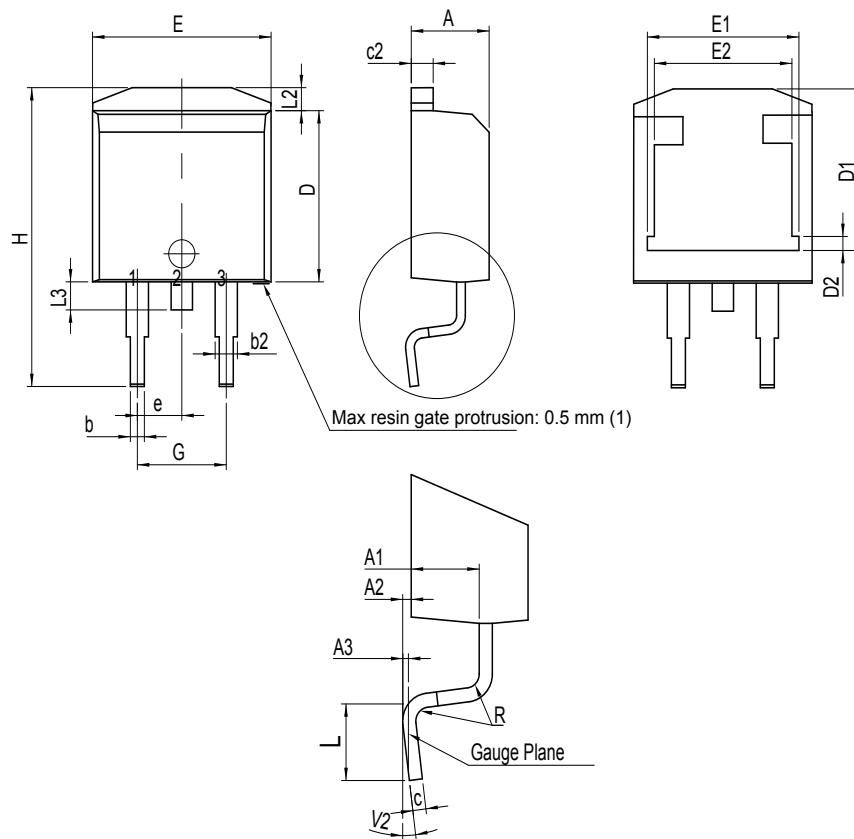

(1) Resin gate is accepted in each of position shown on the drawing, or their symmetrical.

Table 5. D²PAK package mechanical data

Ref.	Dimensions					
	Millimeters			Inches ⁽¹⁾		
	Min.	Typ.	Max.	Min.	Typ.	Max.
A	4.30		4.60	0.1693		0.1811
A1	2.49		2.69	0.0980		0.1059
A2	0.03		0.23	0.0012		0.0091
A3		0.25			0.0098	
b	0.70		0.93	0.0276		0.0366
b2	1.25		1.7	0.0492		0.0669
c	0.45		0.60	0.0177		0.0236
c2	1.21		1.36	0.0476		0.0535
D	8.95		9.35	0.3524		0.3681
D1	7.50		8.00	0.2953		0.3150
D2	1.30		1.70	0.0512		0.0669
e		2.54			0.1	
E	10.00		10.28	0.3937		0.4047
E1	8.30		8.70	0.3268		0.3425
E2	6.85		7.25	0.2697		0.2854
G	4.88		5.28	0.1921		0.2079
H	15		15.85	0.5906		0.6240
L	1.78		2.28	0.0701		0.0898
L2	1.19		1.40	0.0468		0.0551
L3	1.40		1.75	0.0551		0.0689
R		0.40			0.0157	
V2 ⁽²⁾	0°		8°	0°		8°

1. Dimensions in inches are given for reference only

2. Degrees

Figure 15. D²PAK recommended footprint (dimensions are in mm)

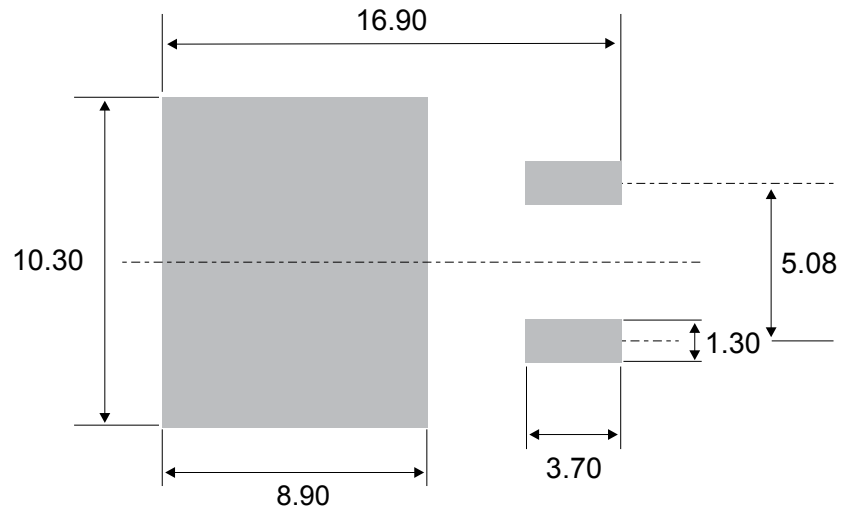
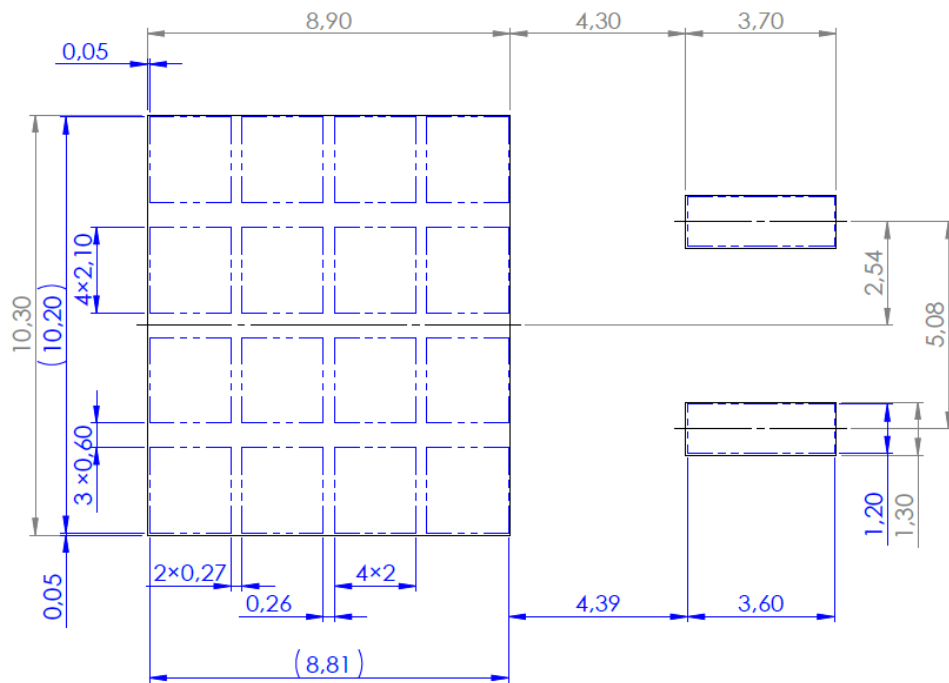

Figure 16. D²PAK stencil definitions (dimensions are in mm)



3 Ordering information

Figure 17. Ordering information scheme

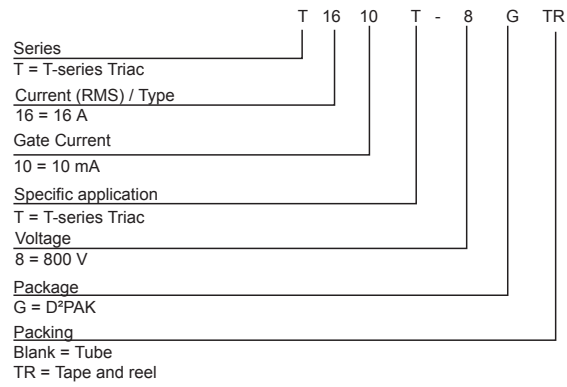

Table 6. Ordering information

Order code	Marking	Package	Weight	Base qty.	Delivery mode
T1610T-8G-TR	T1610T-8G	D ² PAK	1.6 g	1000	Tape and reel
T1610T-8G				50	Tube

Revision history

Table 7. Document revision history

Date	Version	Changes
03-Apr-2018	1	Initial release.
17-Jul-2018	2	Updated Table 2. Electrical characteristics ($T_j = 25\text{ }^\circ\text{C}$, unless otherwise specified).
29-Oct-2020	3	Updated Table 5 and added Figure 13. Thermal resistance junction to ambient versus copper surface under tab. Minor text changes.