

20 A - 600 V H-series Snubberless Triac

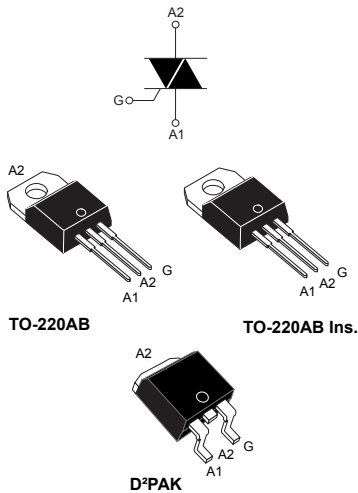

Features

- Medium current Triac
- 150 °C max. T_j turn-off commutation
- Low thermal resistance with clip bonding
- Very high 3 quadrant commutation capabilities
- Packages are RoHS (2002/95/EC) compliant
- UL certified (ref. file E81734)

Applications

Especially designed to operate in high power density or universal motor applications such as vacuum cleaner and washing machine drum motor.

Description

Available in through-hole or surface mount packages, these Triac series are suitable for general purpose mains power ac switching.

These 20 A Triacs provide a very high switching capability up to junction temperatures of 150 °C.

The heatsink can be reduced, compared to traditional Triacs, according to the high performance at given junction temperatures.

By using an internal ceramic pad, they provide voltage insulation (rated at 2500 V_{RMS}).

The surface mount D²PAK package enables compact SMD based designs for automated manufacturing.

Product status link

T2035H-6I, T2035H-6T, T2035H-6G,
T2050H-6I, T2050H-6T, T2050H-6G

Product summary

| | |
|-------------------|-------------|
| $I_{T(RMS)}$ | 20 A |
| V_{DRM}/V_{RRM} | 600 V |
| I_{GT} | 35 or 50 mA |

1 Characteristics

Table 1. Absolute maximum ratings (limiting values)

| Symbol | Parameter | | | Value | Unit |
|-------------------|--|---------------------------------|-----------------------|-------------------------|------------------|
| $I_{T(RMS)}$ | RMS on-state current (full sine wave) | D ² PAK, TO-220AB | $T_c = 128\text{ °C}$ | 20 | A |
| | | TO-220AB Ins. | $T_c = 108\text{ °C}$ | | |
| I_{TSM} | Non repetitive surge peak on-state current (full cycle, T_j initial = 25 °C) | f = 50 Hz | t = 20 ms | 200 | A |
| | | f = 60 Hz | t = 16.7 ms | 210 | |
| I^2t | I^2t value for fusing | | $t_p = 10\text{ ms}$ | 265 | A ² s |
| dI/dt | Critical rate of rise of on-state current, $I_G = 2 \times I_{GT}$, tr ≤ 100 ns, f = 100 Hz | f = 120 Hz | $T_j = 25\text{ °C}$ | 100 | A/μs |
| V_{DSM}/V_{RSM} | Non Repetitive peak off-state voltage | $t_p = 10\text{ ms}$ | $T_j = 25\text{ °C}$ | $V_{DRM}/V_{RRM} + 100$ | V |
| I_{GM} | Peak gate current | $t_p = 20\text{ μs}$ | $T_j = 150\text{ °C}$ | 4 | A |
| $P_{G(AV)}$ | Average gate power dissipation | | $T_j = 150\text{ °C}$ | 1 | W |
| T_{stg} | Storage temperature range | | | -40 to +150 | °C |
| T_j | Operating junction temperature range | | | -40 to +150 | °C |

Table 2. Electrical characteristics ($T_j = 25\text{ °C}$, unless otherwise specified)

| Symbol | Test conditions | Quadrants | | Value | | Unit |
|-------------------------------------|---|-----------------------|------|--------|--------|------|
| | | | | T2035H | T2050H | |
| $I_{GT}^{(1)}$ | $V_D = 12\text{ V}$, $R_L = 33\text{ Ω}$ | I - II - III | Max. | 35 | 50 | mA |
| V_{GT} | | | Max. | 1.0 | | |
| V_{GD} | $V_D = V_{DRM}$, $R_L = 3.3\text{ kΩ}$ | I - II - III | Max. | 0.15 | | V |
| I_L | $I_G = 1.2 \times I_{GT}$ | I - III | Max. | 50 | 90 | mA |
| | | II | Max. | 80 | 110 | |
| $I_H^{(2)}$ | $I_T = 500\text{ mA}$, gate open | | Max. | 35 | 75 | mA |
| dV/dt ⁽²⁾ | $V_D = 2/3 \times V_{DRM}$, gate open | $T_j = 150\text{ °C}$ | Min. | 1000 | 1500 | V/μs |
| (dI/dt) _c ⁽²⁾ | Without snubber | $T_j = 150\text{ °C}$ | Min. | 27 | 36 | A/ms |

1. Minimum I_{GT} is guaranteed at 20% of I_{GT} max.

2. For both polarities of A2 referenced to A1.

Table 3. Static characteristics

| Symbol | Test conditions | | Value | Unit |
|-------------------|--|------------------------------------|-----------|---------------|
| $V_T^{(1)}$ | $I_T = 28 \text{ A}$, $t_p = 380 \mu\text{s}$ | $T_j = 25 \text{ }^\circ\text{C}$ | Max. 1.5 | V |
| $V_{TO}^{(1)}$ | Threshold voltage | $T_j = 150 \text{ }^\circ\text{C}$ | Max. 0.80 | V |
| $R_{D^{(1)}}$ | Dynamic resistance | $T_j = 150 \text{ }^\circ\text{C}$ | Max. 19 | m Ω |
| I_{DRM}/I_{RRM} | $V_D = V_R = 600 \text{ V}$ | $T_j = 25 \text{ }^\circ\text{C}$ | Max. 5 | μA |
| | | $T_j = 150 \text{ }^\circ\text{C}$ | Max. 6.2 | mA |
| | $V_D = V_R = 400 \text{ V}$, peak voltage | $T_j = 150 \text{ }^\circ\text{C}$ | Max. 5.0 | mA |
| | | $T_j = 150 \text{ }^\circ\text{C}$ | Max. 4.0 | |

1. For both polarities of A2 referenced to A1.
2. $t_p = 380 \mu\text{s}$

Table 4. Thermal resistance

| Symbol | Parameter | | Value | Unit |
|---------------|---|---------------------------------|-------|--------------------|
| $R_{th(j-c)}$ | Junction to case (AC) | D ² PAK, TO-220AB | 1.0 | $^\circ\text{C/W}$ |
| | | TO-220AB Ins. | 1.9 | |
| $R_{th(j-a)}$ | Junction to ambient ($S_{cu} = 2 \text{ cm}^2$) | D ² PAK, TO-220AB | 45 | $^\circ\text{C/W}$ |
| | | TO-220AB Ins. | 60 | |

1.1 Characteristics (curves)

Figure 1. Maximum power dissipation versus on-state RMS current

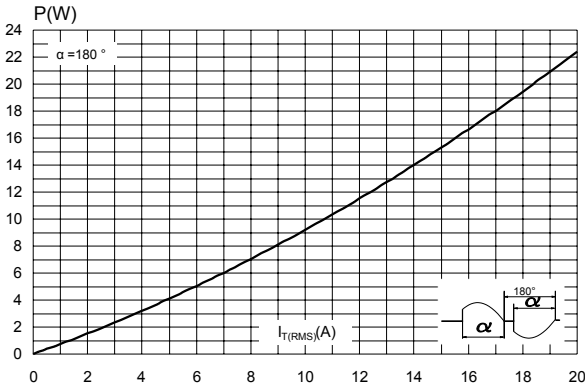

Figure 2. On-state RMS current versus case temperature

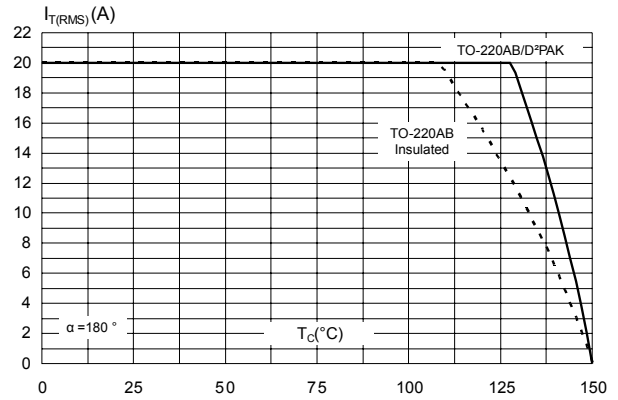

Figure 3. On-state RMS current versus ambient temperature

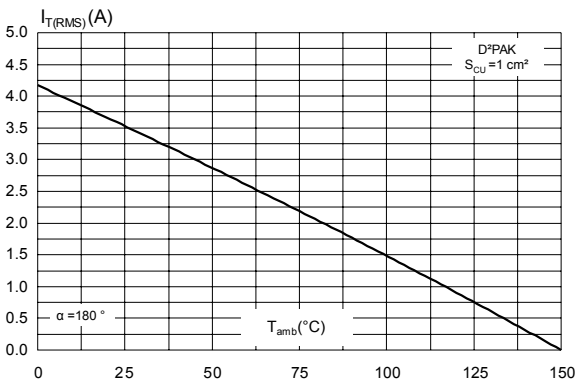

Figure 4. Variation of thermal impedance versus pulse duration

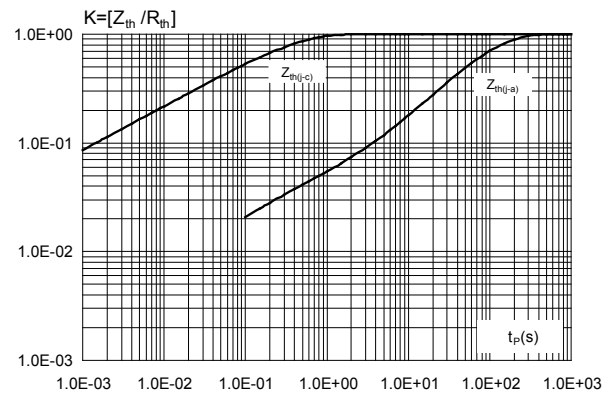

Figure 5. On-state characteristics (maximum values)

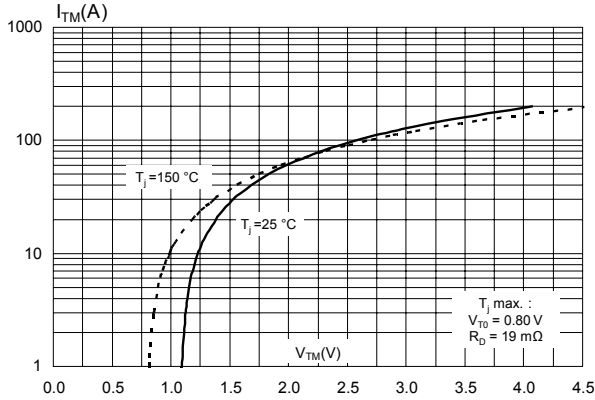

Figure 6. Surge peak on-state current versus number of cycles

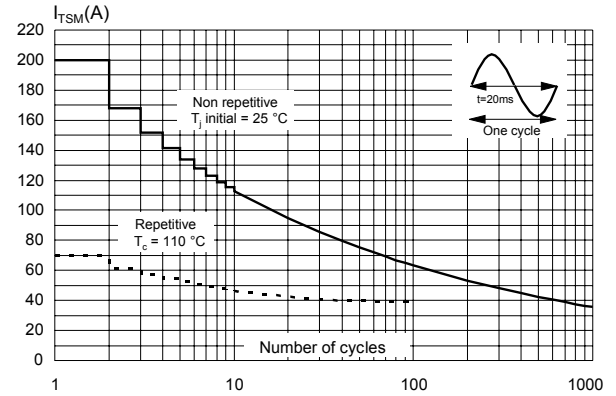

Figure 7. Non-repetitive surge peak on-state current for a sinusoidal pulse

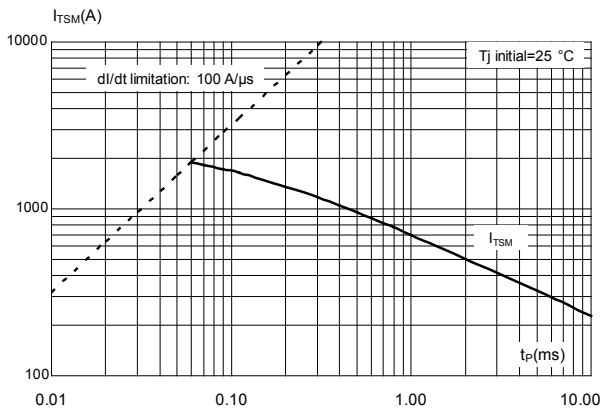

Figure 8. Relative variation of I_{GT}, I_H, I_L vs junction temperature (typical values)

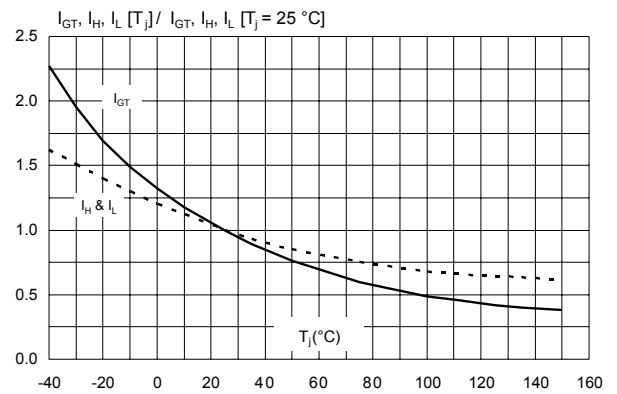

Figure 9. Relative variation of critical rate of decrease of main current $(di/dt)_c$ versus reapplied $(dV/dt)_c$

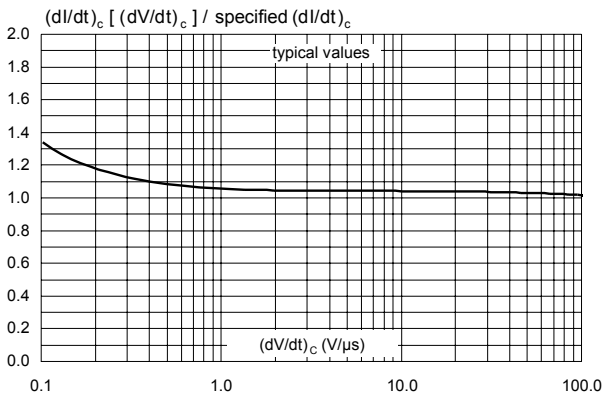

Figure 10. Relative variation of critical rate of decrease of main current versus junction temperature

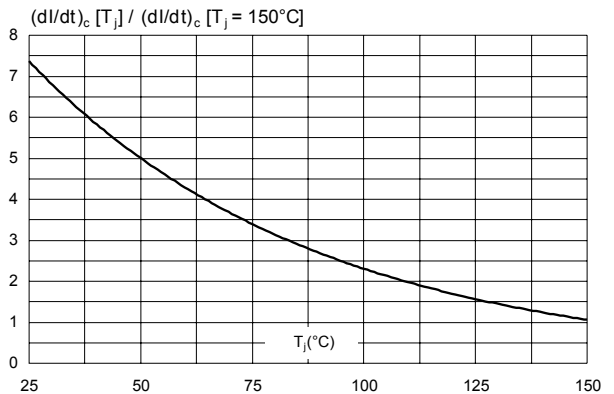

Figure 11. Leakage current versus junction temperature for different values of blocking voltage (typical values)

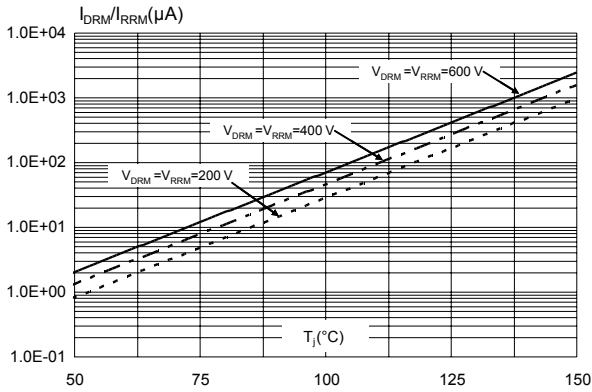

Figure 12. Acceptable repetitive peak off-state voltage versus case to ambient thermal resistance

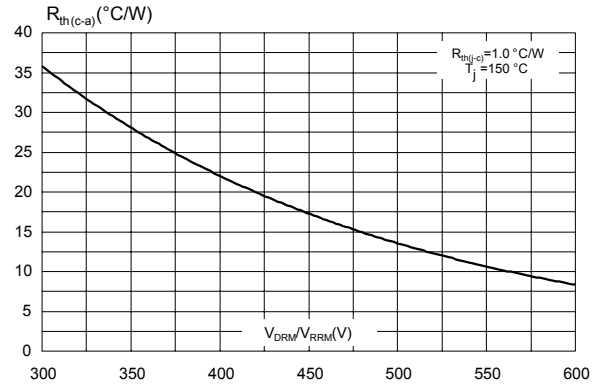
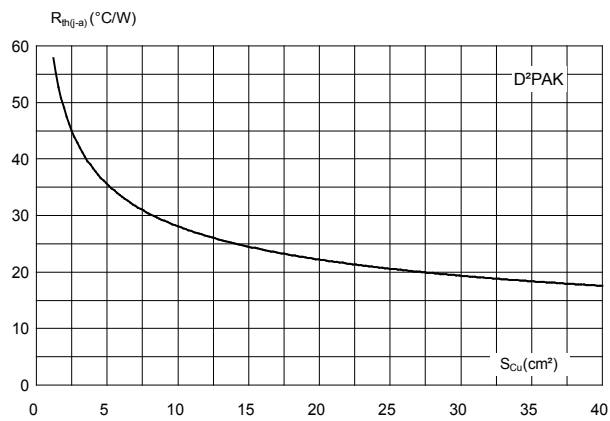

Figure 13. Thermal resistance junction to ambient versus copper surface under tab



2 Package information

In order to meet environmental requirements, ST offers these devices in different grades of **ECOPACK** packages, depending on their level of environmental compliance. ECOPACK specifications, grade definitions and product status are available at: www.st.com. ECOPACK is an ST trademark.

2.1 D²PAK package information

Figure 14. D²PAK package outline

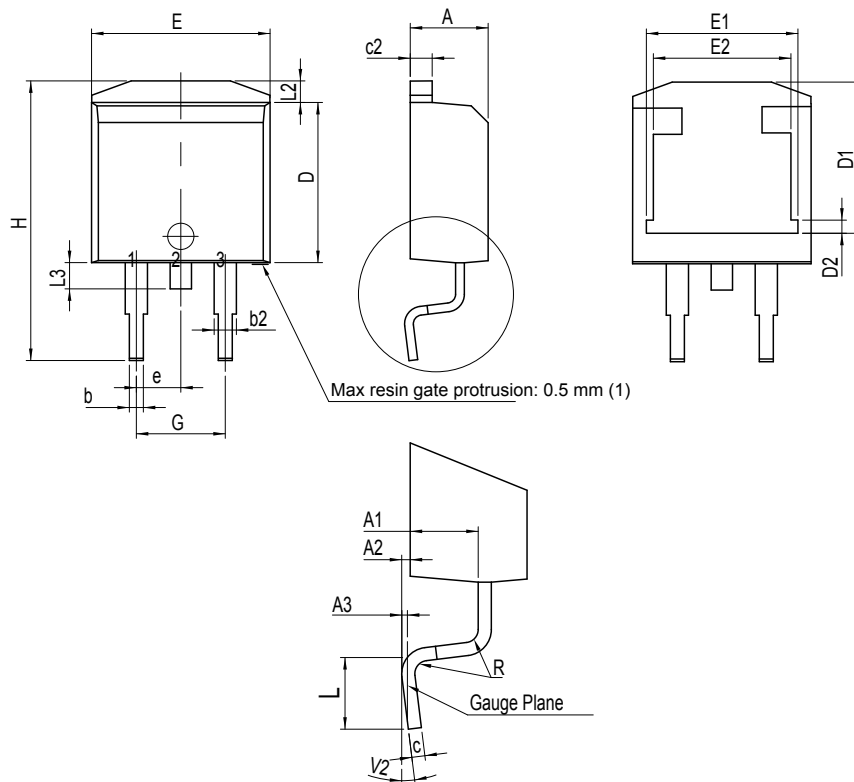

(1) Resin gate is accepted in each of position shown on the drawing, or their symmetrical.

Table 5. D²PAK package mechanical data

| Ref. | Dimensions | | | | | |
|------|-------------|------|-------|-----------------------|--------|--------|
| | Millimeters | | | Inches ⁽¹⁾ | | |
| | Min. | Typ. | Max. | Min. | Typ. | Max. |
| A | 4.30 | | 4.60 | 0.1693 | | 0.1811 |
| A1 | 2.49 | | 2.69 | 0.0980 | | 0.1059 |
| A2 | 0.03 | | 0.23 | 0.0012 | | 0.0091 |
| A3 | | 0.25 | | | 0.0098 | |
| b | 0.70 | | 0.93 | 0.0276 | | 0.0366 |
| b2 | 1.25 | | 1.7 | 0.0492 | | 0.0669 |
| c | 0.45 | | 0.60 | 0.0177 | | 0.0236 |
| c2 | 1.21 | | 1.36 | 0.0476 | | 0.0535 |
| D | 8.95 | | 9.35 | 0.3524 | | 0.3681 |
| D1 | 7.50 | | 8.00 | 0.2953 | | 0.3150 |
| D2 | 1.30 | | 1.70 | 0.0512 | | 0.0669 |
| e | 2.54 | | | 0.1 | | |
| E | 10.00 | | 10.28 | 0.3937 | | 0.4047 |
| E1 | 8.30 | | 8.70 | 0.3268 | | 0.3425 |
| E2 | 6.85 | | 7.25 | 0.2697 | | 0.2854 |
| G | 4.88 | | 5.28 | 0.1921 | | 0.2079 |
| H | 15 | | 15.85 | 0.5906 | | 0.6240 |
| L | 1.78 | | 2.28 | 0.0701 | | 0.0898 |
| L2 | 1.27 | | 1.40 | 0.0500 | | 0.0551 |
| L3 | 1.40 | | 1.75 | 0.0551 | | 0.0689 |
| R | | 0.40 | | | 0.0157 | |
| V2 | 0° | | 8° | 0° | | 8° |

1. Dimensions in inches are given for reference only

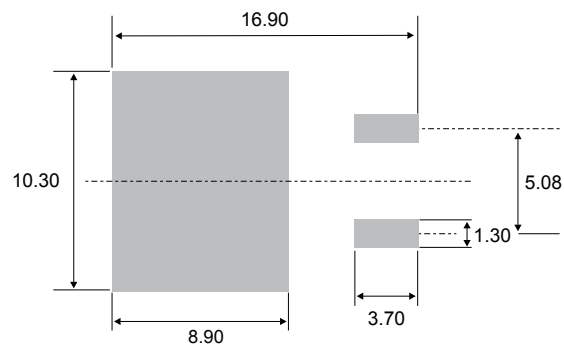
Figure 15. D²PAK recommended footprint (dimensions are in mm)

2.2 TO-220AB package information

- Molding compound resin is halogen-free and meets flammability standard UL94 level 0
- Lead-free package leads finishing
- [ECOPACK2](#) compliant
- Recommended torque: 0.4 to 0.6 N.m

Figure 16. TO-220AB package outline

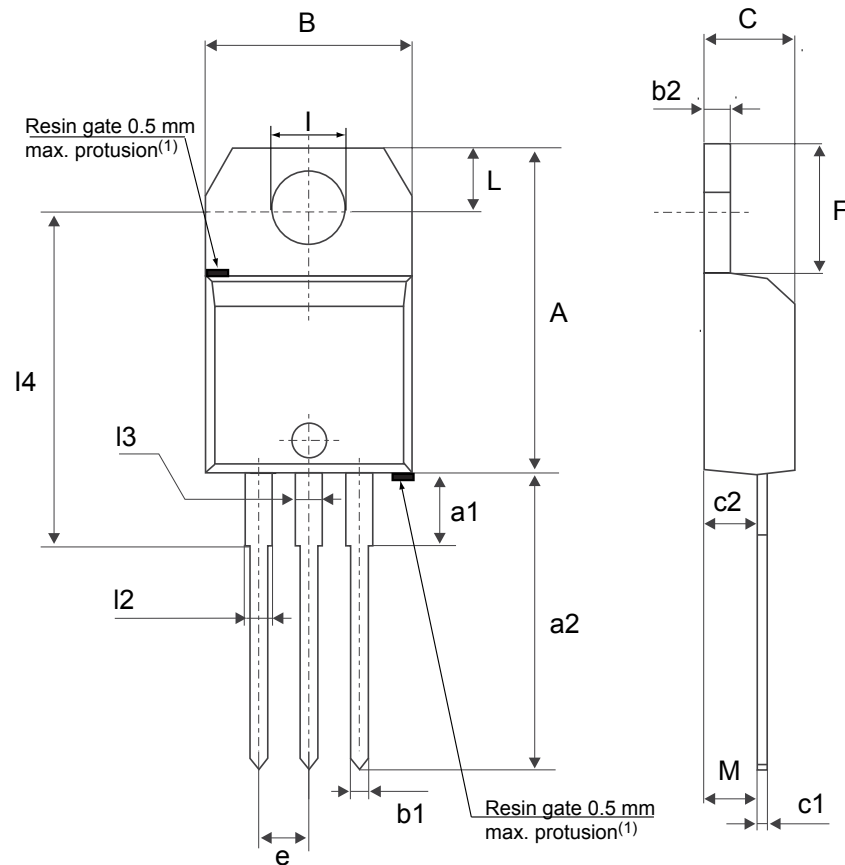

(1) Resin gate position accepted in one of the two positions or in the symmetrical opposites.

Table 6. TO-220AB package mechanical data

| Ref. | Dimensions | | | | | |
|------|-------------|-------|-------|-----------------------|--------|--------|
| | Millimeters | | | Inches ⁽¹⁾ | | |
| | Min. | Typ. | Max. | Min. | Typ. | Max. |
| A | 15.20 | | 15.90 | 0.5984 | | 0.6260 |
| a1 | | 3.75 | | | 0.1476 | |
| a2 | 13.00 | | 14.00 | 0.5118 | | 0.5512 |
| B | 10.00 | | 10.40 | 0.3937 | | 0.4094 |
| b1 | 0.61 | | 0.88 | 0.0240 | | 0.0346 |
| b2 | 1.23 | | 1.32 | 0.0484 | | 0.0520 |
| C | 4.40 | | 4.60 | 0.1732 | | 0.1811 |
| c1 | 0.49 | | 0.70 | 0.0193 | | 0.0276 |
| c2 | 2.40 | | 2.72 | 0.0945 | | 0.1071 |
| e | 2.40 | | 2.70 | 0.0945 | | 0.1063 |
| F | 6.20 | | 6.60 | 0.2441 | | 0.2598 |
| I | 3.73 | | 3.88 | 0.1469 | | 0.1528 |
| L | 2.65 | | 2.95 | 0.1043 | | 0.1161 |
| I2 | 1.14 | | 1.70 | 0.0449 | | 0.0669 |
| I3 | 1.14 | | 1.70 | 0.0449 | | 0.0669 |
| I4 | 15.80 | 16.40 | 16.80 | 0.6220 | 0.6457 | 0.6614 |
| M | | 2.6 | | | 0.1024 | |

1. Inch dimensions are for reference only.

3 Ordering information

Figure 17. Ordering information scheme

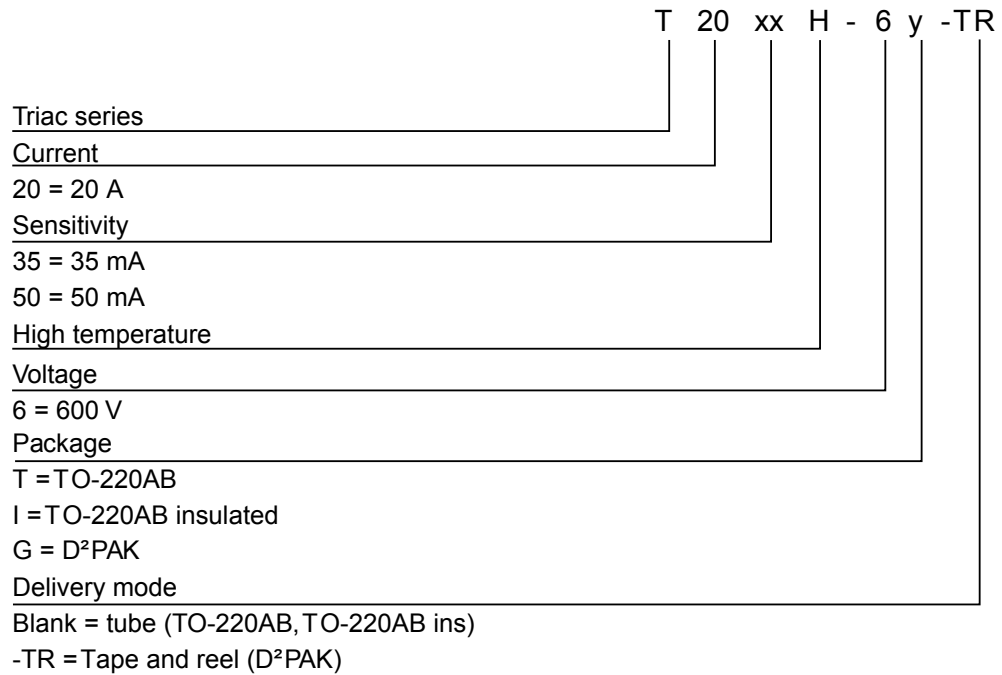

Table 7. Ordering information

| Order code | Marking | Package | Weight | Base qty. | Delivery mode |
|--------------|-----------|--------------------|--------|-----------|-------------------|
| T2035H-6G | T2035H-6G | D ² PAK | 1.5 g | 50 | Tube |
| T2035H-6G-TR | T2035H-6G | | | 1000 | Tape and reel 13" |
| T2035H-6I | T2035H-6I | TO-220AB Ins. | 2.3 g | 50 | Tube |
| T2035H-6T | T2035H-6T | TO-220AB | 2.3 g | 50 | Tube |
| T2050H-6G | T2050H-6G | D ² PAK | 1.5 g | 50 | Tube |
| T2050H-6G-TR | T2050H-6G | | | 1000 | Tape and reel 13" |
| T2050H-6T | T2050H-6T | TO-220AB | 2.3 g | 50 | Tube |

Revision history

Table 8. Document revision history

| Date | Version | Changes |
|-------------|---------|--|
| 31-May-2007 | 1 | First issue. |
| 19-Sep-2011 | 2 | Added TO-220AB Ins and D ² PAK packages. Reformatted to current standards. |
| 08-Aug-2011 | 3 | Updated: Features and Description. Removed order code T20xxH-6G from Figure 14 and Table 8. |
| 05-Jan-2017 | 4 | Updated Figure 4: "Variation of thermal impedance versus pulse duration" , Figure 7: "Non-repetitive surge peak on-state current for a sinusoidal pulse", Section 6.2: "D ² PAK package information", Section 6.3: "TO-220AB (NIns. and Ins.) package information" and Table 8: "Ordering information". |
| 02-Oct-2019 | 5 | Updated description title. Minor text changed. |
| 06-Aug-2021 | 6 | Updated Table 2 . |