

Netz-Thyristor
Phase Control Thyristor
T460N
Elektrische Eigenschaften / Electrical properties
 Höchstzulässige Werte / Maximum rated values

Periodische Vorwärts- und Rückwärts-Spitzensperrspannung repetitive peak forward off-state and reverse voltages	$T_{vj} = -40^{\circ}\text{C} \dots T_{vj \max}$	$V_{\text{DRM}}, V_{\text{RRM}}$	2000 V 2400 V 2600 V
Vorwärts-Stosspitzensperrspannung non-repetitive peak forward off-state voltage	$T_{vj} = -40^{\circ}\text{C} \dots T_{vj \max}$	V_{DSM}	2000 V 2400 V 2600 V
Rückwärts-Stosspitzensperrspannung non-repetitive peak reverse voltage	$T_{vj} = +25^{\circ}\text{C} \dots T_{vj \max}$	V_{RSM}	2300 V 2500 V 2700 V
Durchlassstrom-Grenzeffektivwert maximum RMS on-state current		I_{TRMSM}	1000 A
Dauergrenzstrom average on-state current	$T_C = 85^{\circ}\text{C}$	I_{TAVM}	460 A
Dauergrenzstrom average on-state current	$T_C = 55^{\circ}\text{C}, \theta = 180^{\circ}\sin, t_p = 10 \text{ ms}$	I_{TAVM}	650 A
Durchlaßstrom-Effektivwert RMS on-state current		I_{TRMS}	1030 A
Stossstrom-Grenzwert surge current	$T_{vj} = 25^{\circ}\text{C}, t_p = 10 \text{ ms}$ $T_{vj} = T_{vj \max}, t_p = 10 \text{ ms}$	I_{TSM}	10000 A 9000 A
Grenzlastintegral I^2t -value	$T_{vj} = 25^{\circ}\text{C}, t_p = 10 \text{ ms}$ $T_{vj} = T_{vj \max}, t_p = 10 \text{ ms}$	I^2t	500 $10^3 \text{ A}^2\text{s}$ 405 $10^3 \text{ A}^2\text{s}$
Kritische Stromsteilheit critical rate of rise of on-state current	DIN IEC 60747-6 $f = 50 \text{ Hz}, i_{\text{GM}} = 1,25 \text{ A},$ $di_{\text{G}}/dt = 1,25 \text{ A}/\mu\text{s}$	$(di_{\text{T}}/dt)_{\text{cr}}$	120 A/ μs
Kritische Spannungssteilheit critical rate of rise of off-state voltage	$T_{vj} = T_{vj \max}, V_{\text{D}} = 0,67 V_{\text{DRM}}$ 5.Kennbuchstabe / 5 th letter F	$(dv_{\text{D}}/dt)_{\text{cr}}$	1000 V/ μs

Charakteristische Werte / Characteristic values

Durchlassspannung on-state voltage	$T_{vj} = T_{vj \max}, i_{\text{T}} = 2 \text{ kA}$ $T_{vj} = T_{vj \max}, i_{\text{T}} = 0,4 \text{ kA}$	v_{T}	max. 2,75 V max. 1,21 V
Schleusenspannung threshold voltage	$T_{vj} = T_{vj \max}$	$V_{(\text{TO})}$	1,0 V
Ersatzwiderstand slope resistance	$T_{vj} = T_{vj \max}$	r_{T}	0,84 m Ω
Durchlasskennlinie $100 \text{ A} \leq i_{\text{T}} \leq 2300 \text{ A}$ on-state characteristic $v_{\text{T}} = A + B \cdot i_{\text{T}} + C \cdot \ln(i_{\text{T}} + 1) + D \cdot \sqrt{i_{\text{T}}}$	$T_{vj} = T_{vj \max}$	A= B= C= D=	7,500E-01 7,877E-04 -5,399E-03 1,153E-02
Zündstrom gate trigger current	$T_{vj} = 25^{\circ}\text{C}, v_{\text{D}} = 12\text{V}$	i_{GT}	max. 250 mA
Zündspannung gate trigger voltage	$T_{vj} = 25^{\circ}\text{C}, v_{\text{D}} = 12\text{V}$	V_{GT}	max. 1,5 V
Nicht zündender Steuerstrom gate non-trigger current	$T_{vj} = T_{vj \max}, v_{\text{D}} = 12\text{V}$ $T_{vj} = T_{vj \max}, v_{\text{D}} = 0,5 V_{\text{DRM}}$	i_{GD}	max. 5 mA max. 2,5 mA
Nicht zündende Steuerspannung gate non-trigger voltage	$T_{vj} = T_{vj \max}, v_{\text{D}} = 0,5 V_{\text{DRM}}$	V_{GD}	max. 0,2 V
Haltestrom holding current	$T_{vj} = 25^{\circ}\text{C}, v_{\text{D}} = 12\text{V}$	i_{H}	max. 200 mA
Einraststrom latching current	$T_{vj} = 25^{\circ}\text{C}, v_{\text{D}} = 12\text{V}, R_{\text{GK}} \geq 10 \Omega$ $i_{\text{GM}} = 1,25 \text{ A}, di_{\text{G}}/dt = 1,25 \text{ A}/\mu\text{s},$ $t_{\text{g}} = 20 \mu\text{s}$	i_{L}	max. 620 mA
Vorwärts- und Rückwärts-Sperrstrom forward off-state and reverse current	$T_{vj} = T_{vj \max}$ $v_{\text{D}} = V_{\text{DRM}}, v_{\text{R}} = V_{\text{RRM}}$	$i_{\text{D}}, i_{\text{R}}$	max. 80 mA
Zündverzug gate controlled delay time	DIN IEC 60747-6 $T_{vj} = 25^{\circ}\text{C}, i_{\text{GM}} = 1,25 \text{ A},$ $di_{\text{G}}/dt = 1,25 \text{ A}/\mu\text{s}$	t_{gd}	max. 3,3 μs

prepared by:	H.Sandmann	date of publication:	2008-10-16
approved by:	M.Leifeld	revision:	1.0

Netz-Thyristor
Phase Control Thyristor
T460N
Elektrische Eigenschaften / Electrical properties
 Charakteristische Werte / Characteristic values

Freiwerdezeit circuit commutated turn-off time	$T_{vj} = T_{vj\ max}$, $i_{TM} = I_{TAVM}$ $V_{RM} = 100\ V$, $V_{DM} = 0,67\ V_{DRM}$ $dv_D/dt = 20\ V/\mu s$, $-di_T/dt = 10\ A/\mu s$ 4.Kennbuchstabe / 4 th letter O	t_q	typ. 300 μs
---	--	-------	------------------

Thermische Eigenschaften / Thermal properties

Innerer Wärmewiderstand thermal resistance, junction to case	<u>Kühlfläche / cooling surface</u> beidseitig / two-sided, $\theta = 180^\circ\ sin$ beidseitig / two-sided, DC Anode / anode, $\theta = 180^\circ\ sin$ Anode / anode, DC Kathode / cathode, $\theta = 180^\circ\ sin$ Kathode / cathode, DC	R_{thJC}	max. 0,0455 °C/W max. 0,0440 °C/W max. 0,0665 °C/W max. 0,0650 °C/W max. 0,1375 °C/W max. 0,1360 °C/W
Übergangs-Wärmewiderstand thermal resistance, case to heatsink	<u>Kühlfläche / cooling surface</u> beidseitig / two-sides einseitig / single-sides	R_{thCH}	max. 0,005 °C/W max. 0,010 °C/W
Höchstzulässige Sperrschichttemperatur maximum junction temperature		$T_{vj\ max}$	125 °C
Betriebstemperatur operating temperature		$T_{c\ op}$	-40...+125 °C
Lagertemperatur storage temperature		T_{stg}	-40...+150 °C

Mechanische Eigenschaften / Mechanical properties

Gehäuse, siehe Anlage case, see annex			Seite 3 page 3
Si-Element mit Druckkontakt Si-pellet with pressure contact			
Anpresskraft clamping force		F	7,5..17,5 kN
Steueranschlüsse control terminals	Gate (flat) Gate (round, based on AMP 60598) Kathode / cathode		A 2,8x0,5 mm Ø 1,5 mm A 4,8x0,5 mm
Gewicht weight		G	typ. 270 g
Kriechstrecke creepage distance			20 mm
Schwingfestigkeit vibration resistance	f = 50 Hz		50 m/s ²



Netz-Thyristor
Phase Control Thyristor

T460N

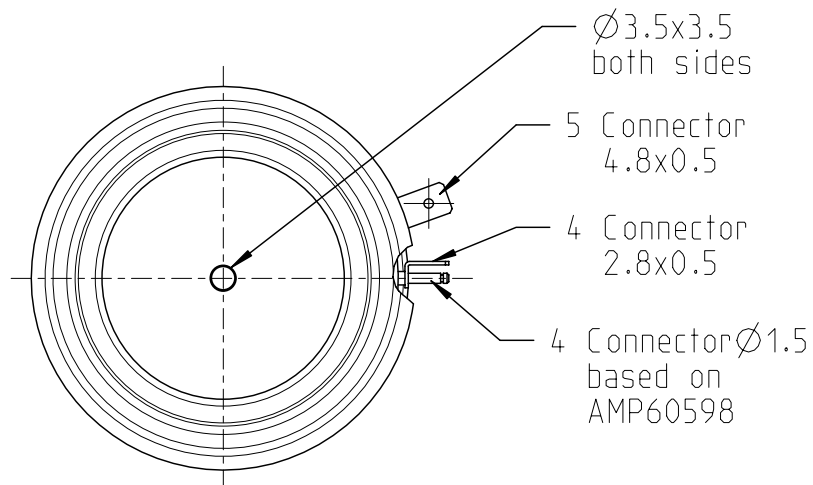
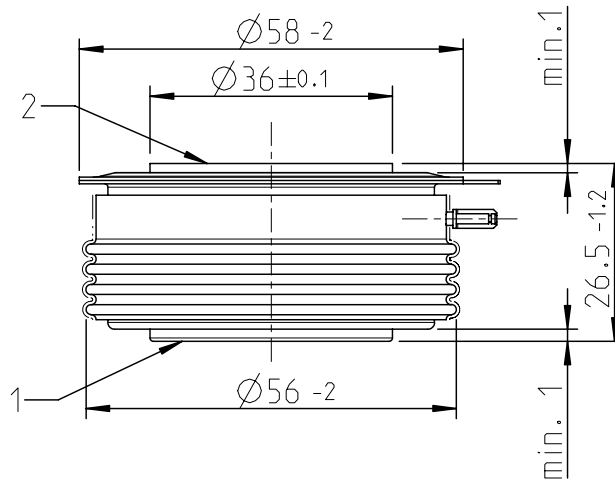

strike distance: 15mm
creepage distance: 20mm

overall height based
on contact pressure

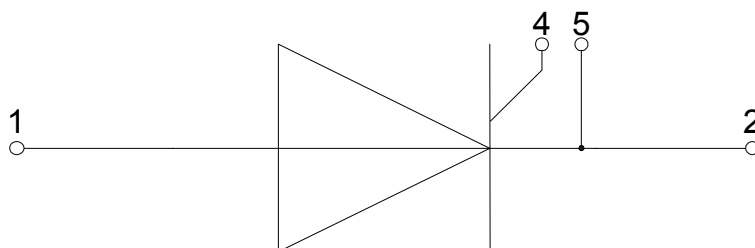

- 1:** Anode / Anode
- 2:** Kathode / Cathode
- 4:** Gate
- 5:** Hilfskathode/
Auxiliary Cathode



Netz-Thyristor
Phase Control Thyristor

T460N

Analytische Elemente des transienten Wärmewiderstandes Z_{thJC} für DC
Analytical elements of transient thermal impedance Z_{thJC} for DC

Kühlung / Cooling	Pos. n	1	2	3	4	5	6	7
beidseitig two-sided	R_{thn} [$^{\circ}C/W$]	0,00200	0,0078	0,0154	0,0188	-	-	-
	τ_n [s]	0,00093	0,0203	0,2730	1,5700	-	-	-
anodenseitig anode-sided	R_{thn} [$^{\circ}C/W$]	0,00228	0,00732	0,0195	0,0199	0,016	-	-
	τ_n [s]	0,00110	0,02160	0,3650	2,7300	14,40	-	-
kathodenseitig cathode-sided	R_{thn} [$^{\circ}C/W$]	0,00260	0,0093	0,0234	0,0318	0,0487	0,0202	-
	τ_n [s]	0,00125	0,0300	0,7270	4,5800	21,000	123,00	-

Analytische Funktion / Analytical function:

$$Z_{thJC} = \sum_{n=1}^{n_{max}} R_{thn} \left(1 - e^{-\frac{t}{\tau_n}} \right)$$

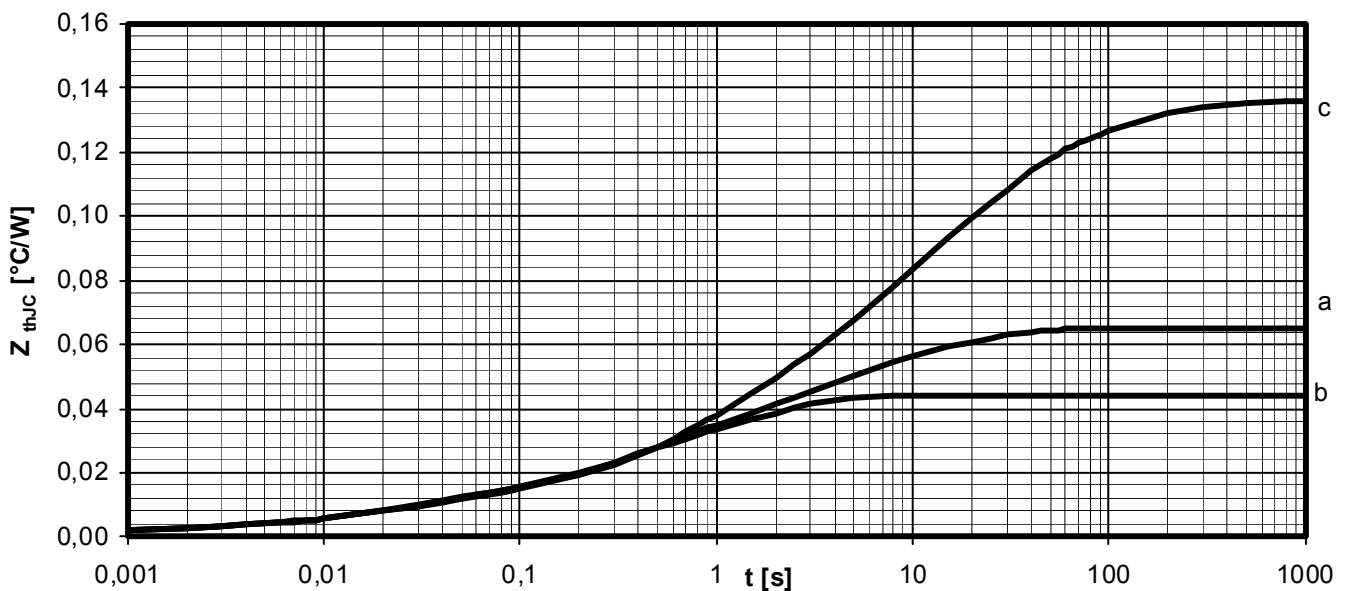

Transienter innerer Wärmewiderstand für DC / Transient thermal impedance for DC
 $Z_{thJC} = f(t)$

- a - Anodenseitige Kühlung / Anode-sided cooling
- b - Beidseitige Kühlung / Two-sided cooling
- c - Kathodenseitige Kühlung / Cathode-sided cooling

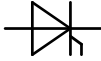

Netz-Thyristor
Phase Control Thyristor

T460N

Erhöhung des $Z_{th DC}$ bei Sinus und Rechteckströmen mit unterschiedlichen Stromflusswinkeln Θ
Rise of $Z_{th DC}$ for sinewave and rectangular current with different current conduction angles Θ

$\Delta Z_{th \Theta rec} / \Delta Z_{th \Theta sin}$

Kühlung / Cooling		$\Theta = 180^\circ$	$\Theta = 120^\circ$	$\Theta = 90^\circ$	$\Theta = 60^\circ$	$\Theta = 30^\circ$
beidseitig two-sided	$\Delta Z_{th \Theta rec}$ [°C/W]	0,00423	0,00710	0,00955	0,01376	0,02262
	$\Delta Z_{th \Theta sin}$ [°C/W]	0,00187	0,00292	0,00450	0,00782	0,01673
anodenseitig anode-sided	$\Delta Z_{th \Theta rec}$ [°C/W]	0,00425	0,00729	0,00991	0,01435	0,02313
	$\Delta Z_{th \Theta sin}$ [°C/W]	0,00187	0,00302	0,00481	0,00852	0,01773
kathodenseitig cathode-sided	$\Delta Z_{th \Theta rec}$ [°C/W]	0,00434	0,00753	0,01036	0,01504	0,02388
	$\Delta Z_{th \Theta sin}$ [°C/W]	0,00190	0,00314	0,00515	0,00920	0,01872

$$Z_{th \Theta rec} = Z_{th DC} + \Delta Z_{th \Theta rec}$$

$$Z_{th \Theta sin} = Z_{th DC} + \Delta Z_{th \Theta sin}$$

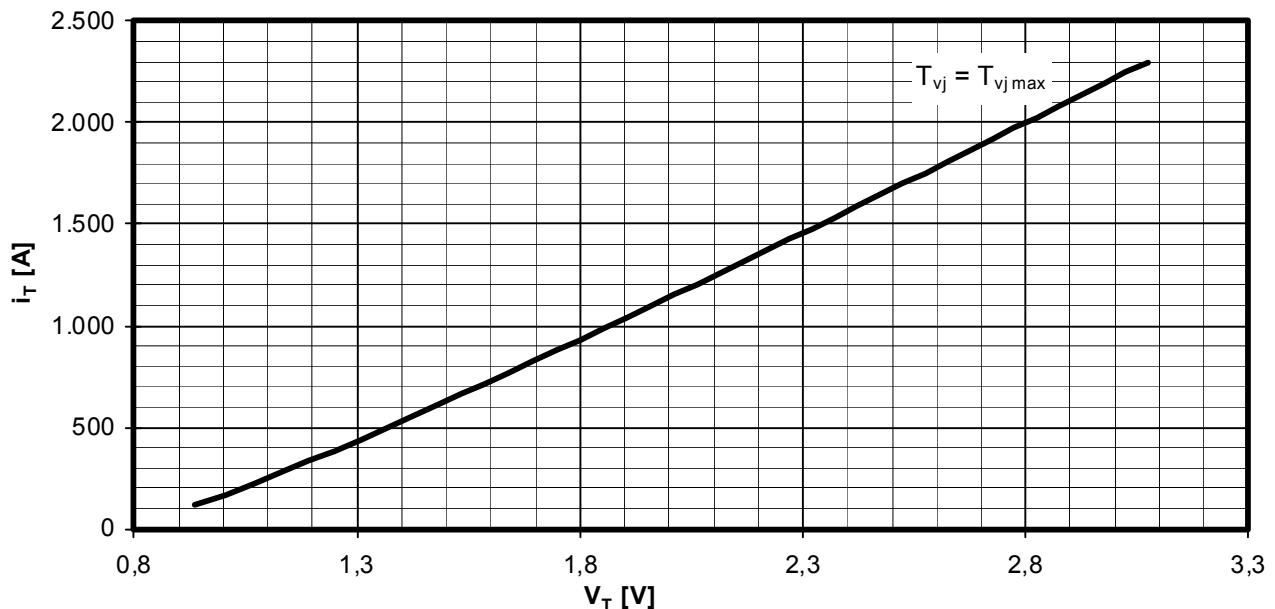

Grenzdurchlasskennlinie / Limiting on-state characteristic $i_T = f(v_T)$

$$T_{vj} = T_{vj \max}$$



Netz-Thyristor
Phase Control Thyristor

T460N

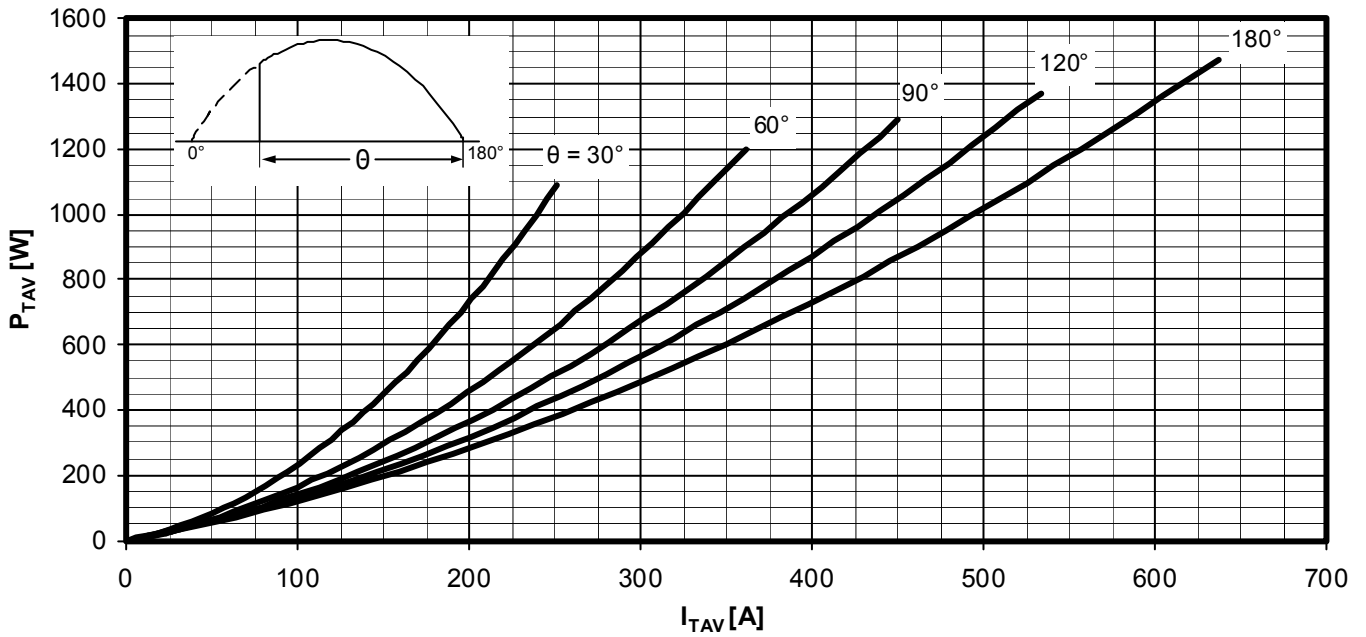

Durchlassverlustleistung / On-state power loss $P_{TAV} = f(I_{TAV})$

Sinusförmiger Strom / Sinusoidal current

Parameter: Stromflusswinkel Θ / Current conduction angle Θ

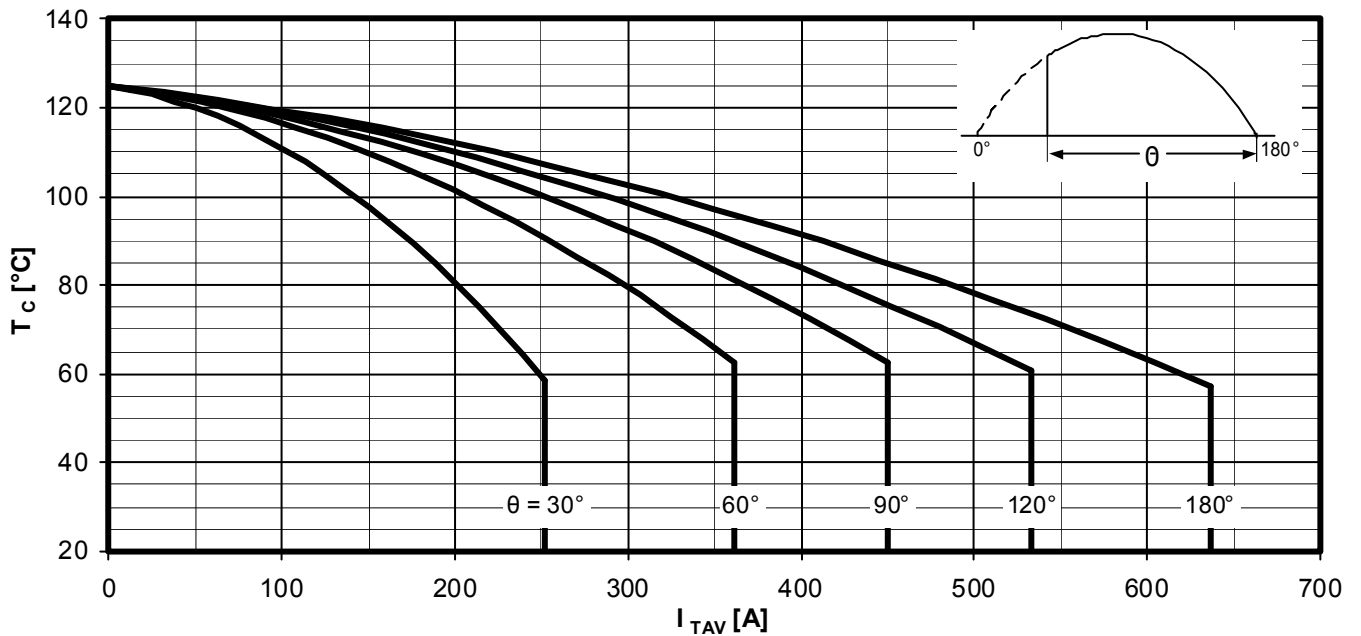

Höchstzulässige Gehäusetemperatur / Maximum allowable case temperature $T_c = f(I_{TAV})$

Sinusförmiger Strom / Sinusoidal current

Beidseitige Kühlung / Two-sided cooling

Parameter: Stromflusswinkel Θ / Current conduction angle Θ



Netz-Thyristor
Phase Control Thyristor

T460N

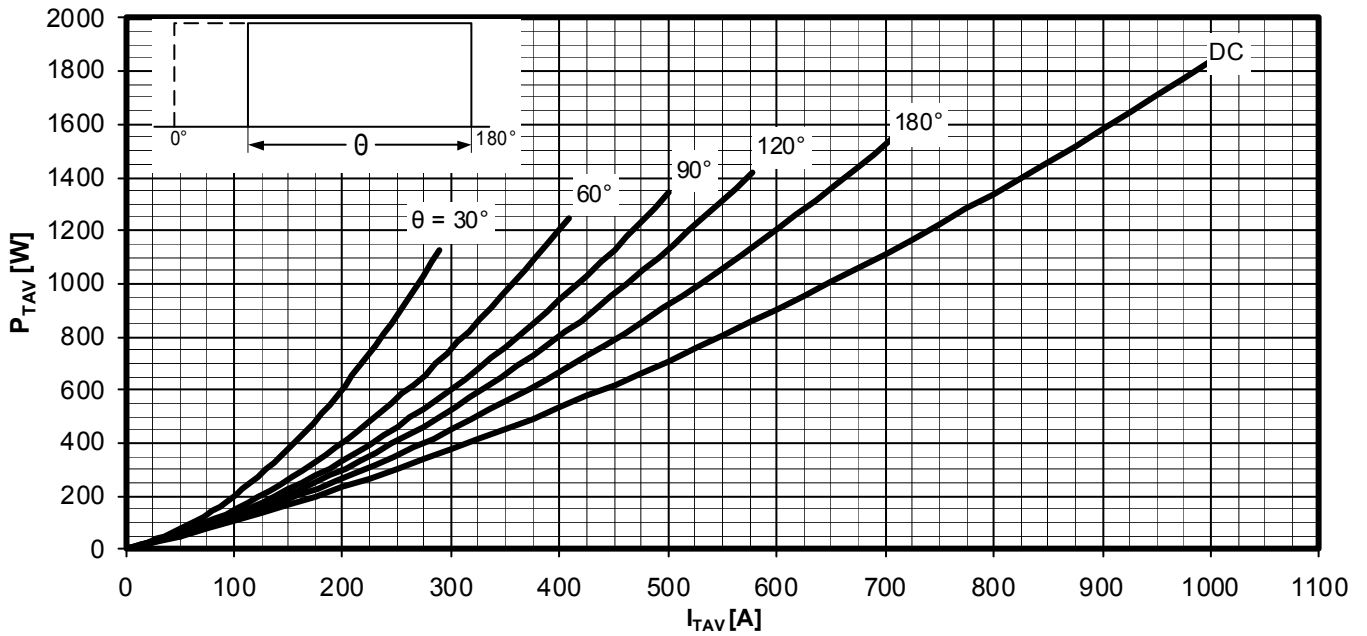

Durchlassverlustleistung / On-state power loss $P_{TAV} = f(I_{TAV})$

Rechteckförmiger Strom / Rectangular current

Parameter: Stromflusswinkel Θ / Current conduction angle Θ

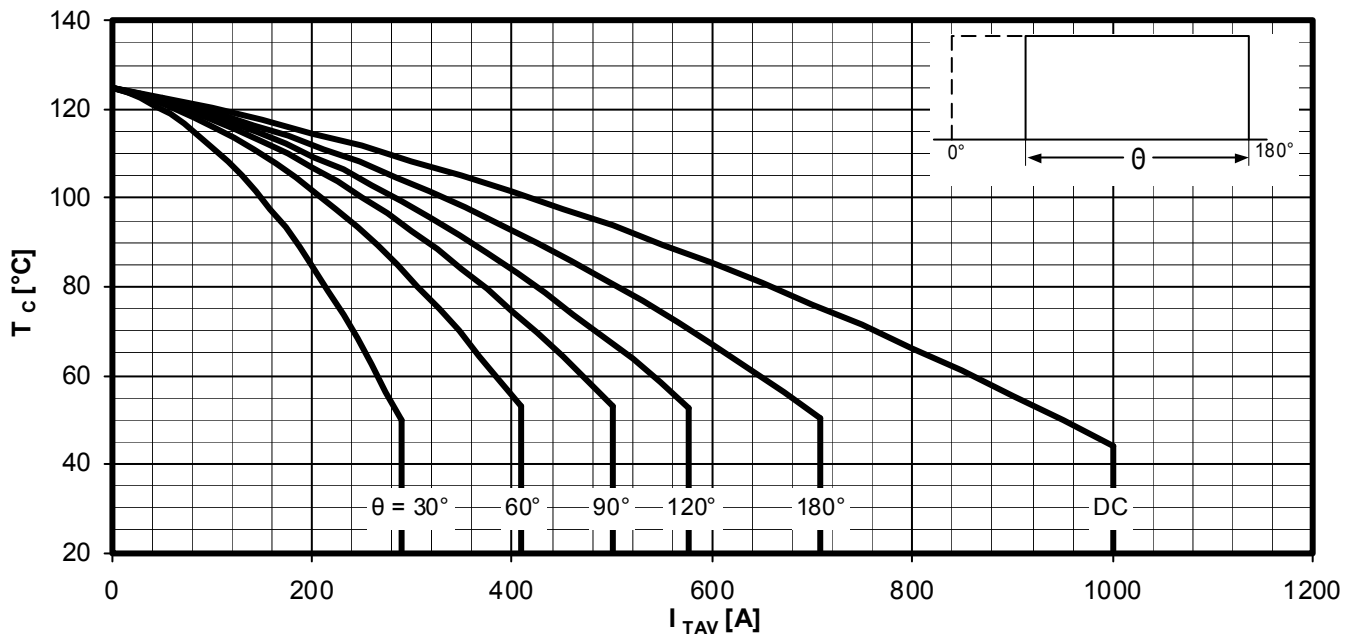

Höchstzulässige Gehäusetemperatur / Maximum allowable case temperature $T_c = f(I_{TAV})$

Rechteckförmiger Strom / Rectangular current

Beidseitige Kühlung / Two-sided cooling

Parameter: Stromflusswinkel Θ / Current conduction angle Θ



Netz-Thyristor
Phase Control Thyristor

T460N

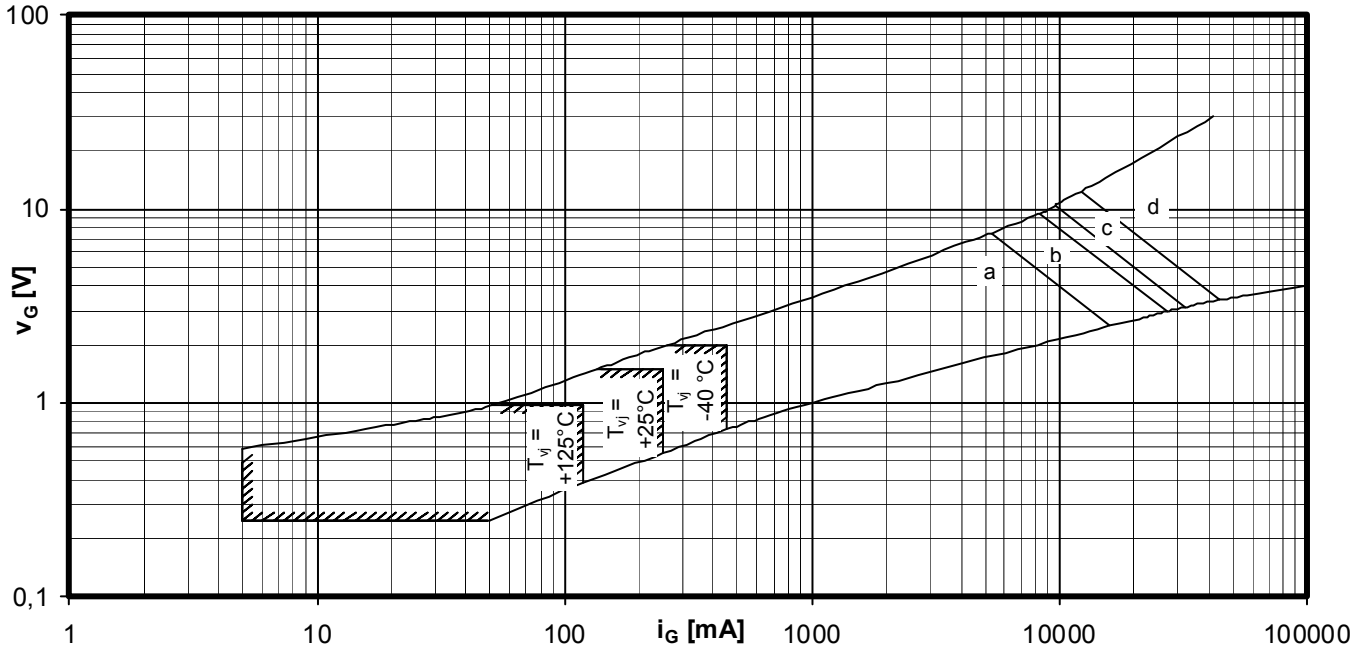

Steuercharakteristik $v_G = f(i_G)$ mit Zündbereichen für $V_D = 12\text{ V}$
Gate characteristic $v_G = f(i_G)$ with triggering area for $V_D = 12\text{ V}$

Höchstzulässige Spitzensteuerverlustleistung / Maximum rated peak gate power dissipation $P_{GM} = f(t_g)$:

- a - 40W / 10ms b - 80W / 1ms c - 100W / 0,5ms d - 150W / 0,1ms

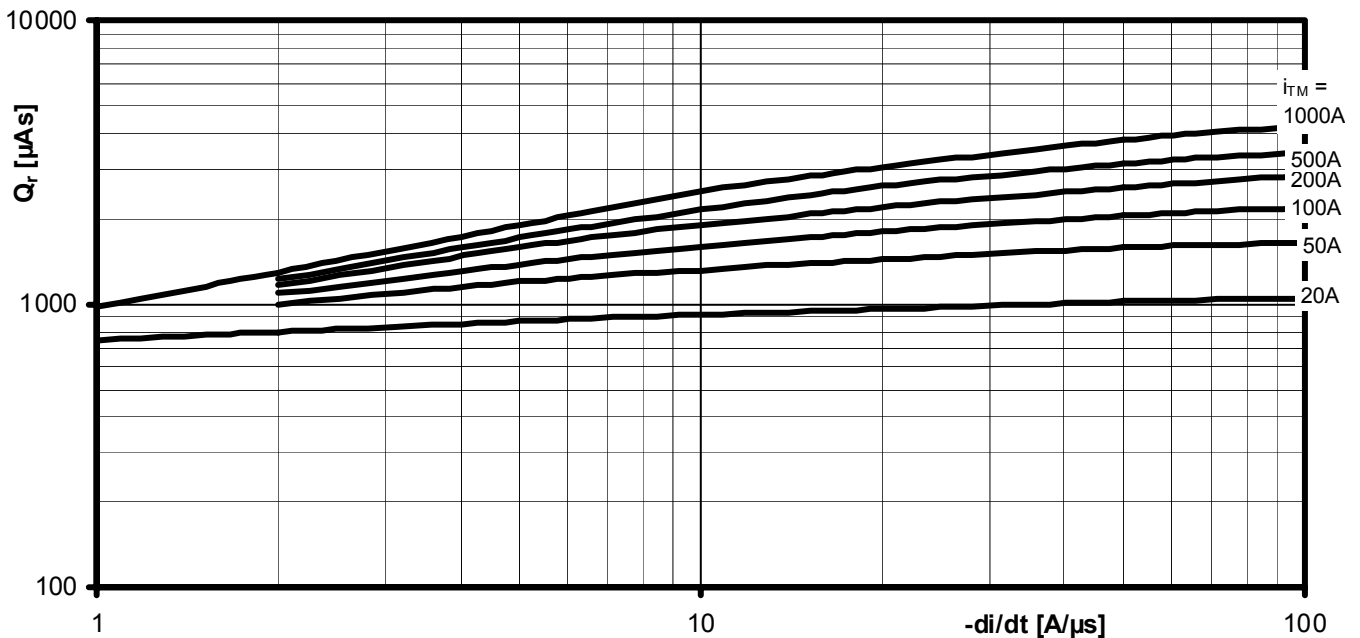

Sperrverzögerungsladung / Recovered charge $Q_r = f(di/dt)$

$T_{vj} = T_{vjmax}, V_R \leq 0,5 V_{RRM}, V_{RM} = 0,8 V_{RRM}$

Parameter: Durchlassstrom / On-state current i_{TM}

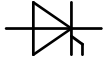

Netz-Thyristor
Phase Control Thyristor

T460N

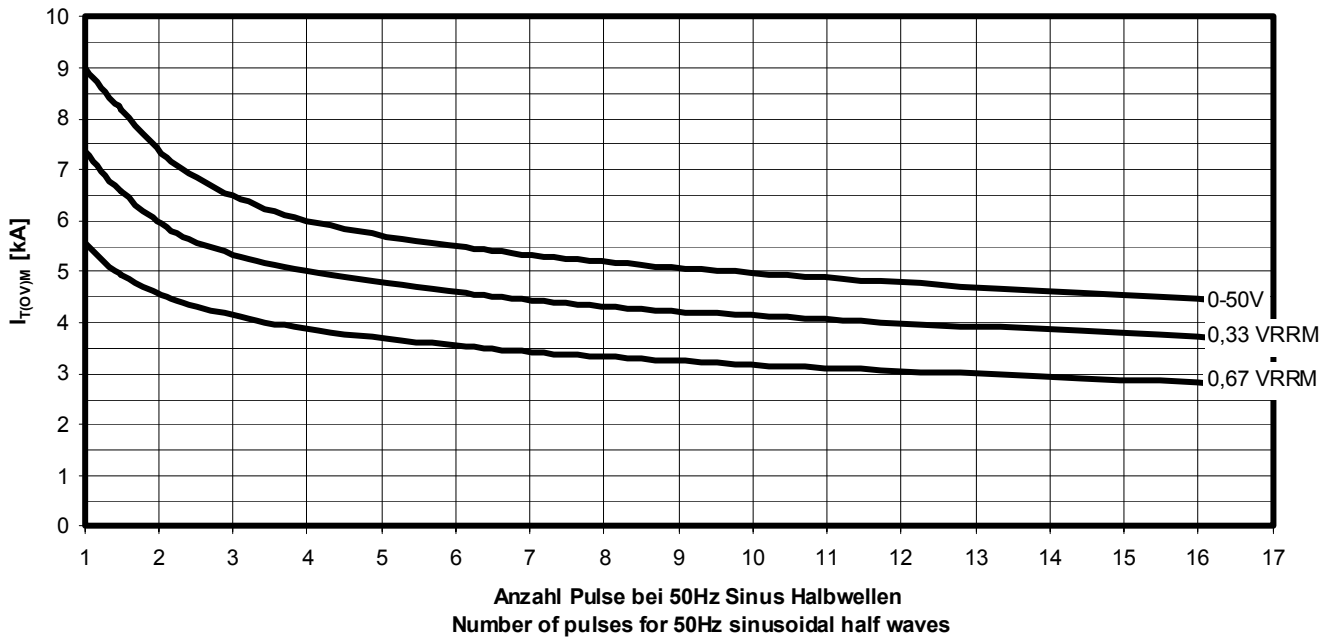

Typische Abhängigkeit des Grenzstromes $I_{T(OV)M}$ von der Anzahl für eine Folge von Sinus Halbwellen bei 50Hz. Parameter: Rückwärtsspannung V_{RM}
 Typical dependency of maximum overload on-state current $I_{T(OV)M}$ as a number of a sequence of sinusoidal half waves at 50Hz. Parameter: peak reverse voltage V_{RM}
 $I_{T(OV)M} = f(\text{pulses}, V_{RM}) ; T_{vj} = T_{vjmax}$