

50 A - 800 V - 150 °C 8H-Triac in TOP3 Ins.

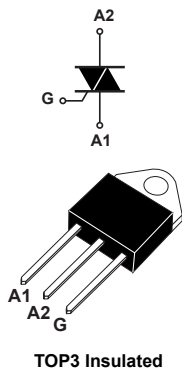

Features

- 50 A RMS Snubberless Triac
- 800 V symmetrical blocking voltage
- 150 °C maximum junction temperature T_j
- Three triggering quadrants
- High noise immunity - static dV/dt
- Robust dynamic turn-off commutation - $(di/dt)_c$
- ECOPACK2 compliant component
- Molding resin UL94-V0 Flammability certified
- Comply with UL1557 insulation: 2.5 kV
 - Reference file: E81734

Applications

- Home automation Smart AC plug
- Water heater, room heater and coffee machine
- AC Induction and Universal Motor control
- Inrush current limiter in AC DC rectifiers
- Lighting and automation I/O control
- General purpose AC line load control

Product status link

[T5035H-8PI](#)

Product summary

$I_{T(RMS)}$	50 A
V_{DRM}/V_{RRM}	800 V
V_{DSM}/V_{RSM}	900 V
I_{GT}	35 mA
$T_j \text{ max.}$	150 °C

Description

This 50 A Triac housed in TOP3 insulated is designed to operate at 800 V and 150 °C. The T5035H-8PI Triac provides an enhanced thermal management: this is the right choice for a compact drive of heavy AC loads and enables the heatsink size reduction.

Based on the latest ST high temperature Snubberless technology, it offers our highest specified turn off commutation and noise immunity levels at the $T_j \text{ max.}$

The T5035H-8PI safely optimizes the control of the motors, heaters and inductive loads for the most constraining environments of industrial and home appliances.

By using an internal ceramic pad, it provides a recognized voltage insulation, rated at 2500 V_{RMS} .

1 Characteristics

Table 1. Absolute maximum ratings (limiting values)

Symbol	Parameter		Value	Unit
$I_{T(RMS)}$	RMS on-state current (full sine wave)	$T_c = 97\text{ °C}$	50	A
I_{TSM}	Non repetitive surge peak on-state current (full cycle, T_j initial = 25 °C)	$t = 16.7\text{ ms}$	525	A
		$t = 20\text{ ms}$	500	
I^2t	I^2t value for fusing	$t_p = 10\text{ ms}$	1653	A ² s
di/dt	Critical rate of rise of on-state current, $I_G = 2 \times I_{GT}$, $t_r \leq 100\text{ ns}$, $f = 100\text{ Hz}$	$T_j = 25\text{ °C}$	100	A/ μ s
V_{DRM}/V_{RRM}	Repetitive peak off-state voltage		800	V
V_{DSM}/V_{RSM}	Non Repetitive peak off-state voltage	$t_p = 10\text{ ms}$, $T_j = 25\text{ °C}$	900	V
I_{GM}	Maximum peak gate current	$t_p = 20\text{ }\mu\text{s}$, $T_j = 150\text{ °C}$	4	A
P_{GM}	Maximum gate power dissipation		5	W
$P_{G(AV)}$	Average gate power dissipation	$T_j = 150\text{ °C}$	1	W
T_{stg}	Storage temperature range		-40 to +150	°C
T_j	Operating junction temperature range		-40 to +150	°C
T_L	Maximum lead temperature for soldering during 10 s		260	°C
V_{INS}	Insulation RMS voltage, 1 minute		2.5	kV

Table 2. Electrical characteristics ($T_j = 25\text{ °C}$, unless otherwise specified)

Symbol	Test conditions		Quadrants		Value	Unit
I_{GT}	$V_D = 12\text{ V}$, $R_L = 30\text{ }\Omega$		I - II - III	Min.	5	mA
	$V_D = 12\text{ V}$, $R_L = 30\text{ }\Omega$		I - II - III	Max.	35	mA
V_{GT}	$V_D = 12\text{ V}$, $R_L = 30\text{ }\Omega$		I - II - III	Max.	1.3	V
V_{GD}	$V_D = V_{DRM}$, $R_L = 3.3\text{ k}\Omega$	$T_j = 150\text{ °C}$	I - II - III	Min.	0.15	V
I_L	$I_G = 1.2 \times I_{GT}$		I - III	Max.	75	mA
			II	Max.	90	mA
$I_H^{(1)}$	$I_T = 500\text{ mA}$, gate open			Max.	60	mA
$dV/dt^{(1)}$	$V_D = 536\text{ V}$, gate open		$T_j = 150\text{ °C}$	Min.	2000	V/ μ s
$(di/dt)_c^{(1)}$	Without snubber network		$T_j = 150\text{ °C}$	Min.	40	A/ms

1. For both polarities of A2 referenced to A1.

Table 3. Static characteristics

Symbol	Test conditions	T_j		Value	Unit
$V_{TM}^{(1)}$	$I_{TM} = 70 \text{ A}$, $t_p = 380 \mu\text{s}$	25 °C	Max.	1.55	V
$V_{TO}^{(1)}$	Threshold voltage	150 °C	Max.	0.80	V
$R_D^{(1)}$	Dynamic resistance	150 °C	Max.	10	mΩ
I_{DRM}/I_{RRM}	$V_D = V_R = V_{DRM} = V_{RRM}$	25 °C	Max.	10	μA
		150 °C		12.5	mA
	$V_D = V_R = 400 \text{ V}$, peak voltage	150 °C	Max.	5	mA

1. For both polarities of A2 referenced to A1.

Table 4. Thermal resistance

Symbol	Parameter		Value	Unit
$R_{th(j-c)}$	Junction to case (AC)	Max.	0.87	°C/W
$R_{th(j-a)}$	Junction to ambient	Typ.	50	°C/W

1.1 Characteristics (curves)

Figure 1. Maximum power dissipation versus on-state RMS current (full cycle)

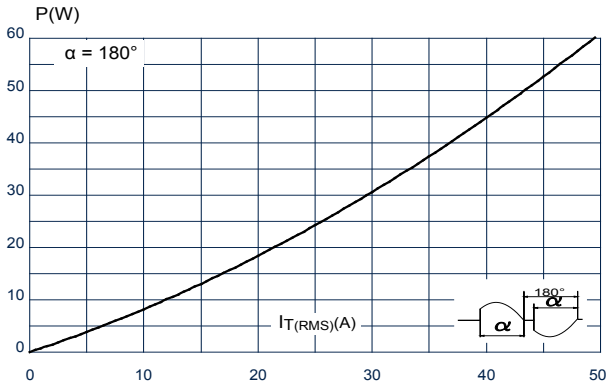

Figure 2. On-state RMS current versus case temperature (full cycle)

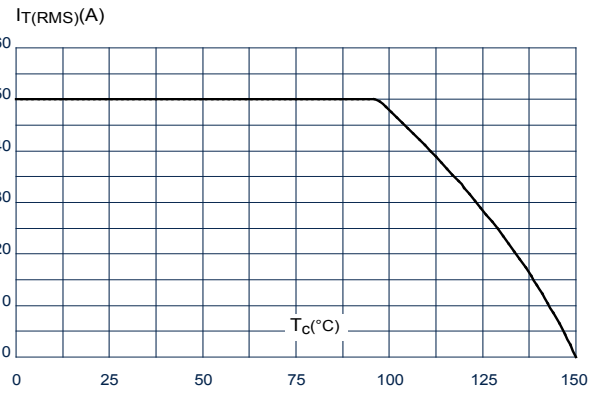

Figure 3. On-state RMS current versus ambient temperature (free air convection)

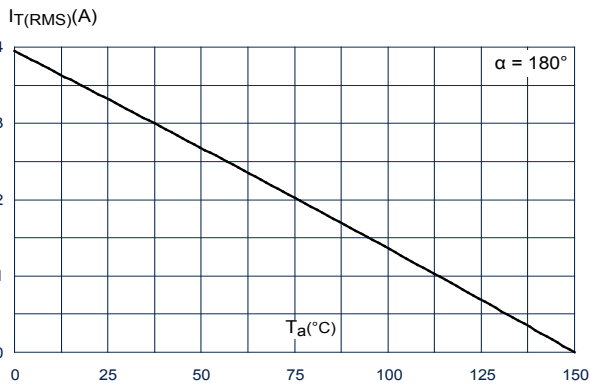

Figure 4. On-state characteristics (maximum values)

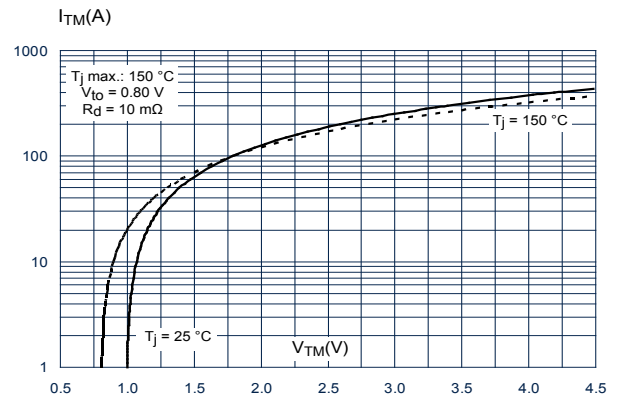

Figure 5. Relative variation of gate triggering current and voltage versus junction temperature (typical values)

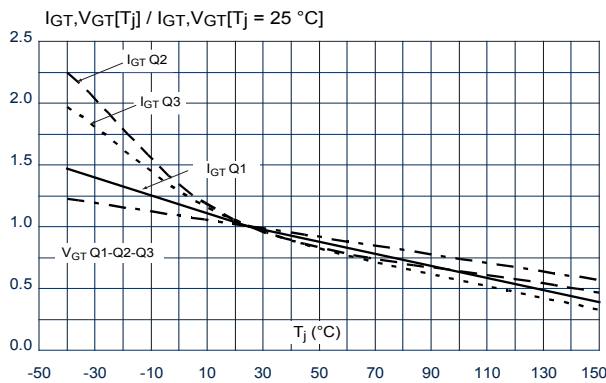

Figure 6. Relative variation of holding current and latching current versus junction temperature (typical values)

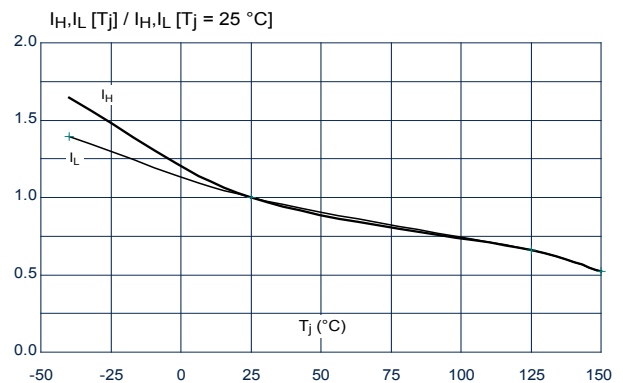

Figure 7. Relative variation of static dV/dt immunity versus junction temperature

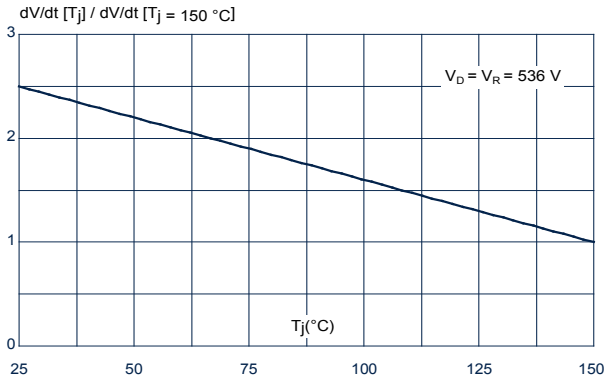

Figure 8. Relative variation of critical rate of decrease of current (dl/dt)c versus junction temperature

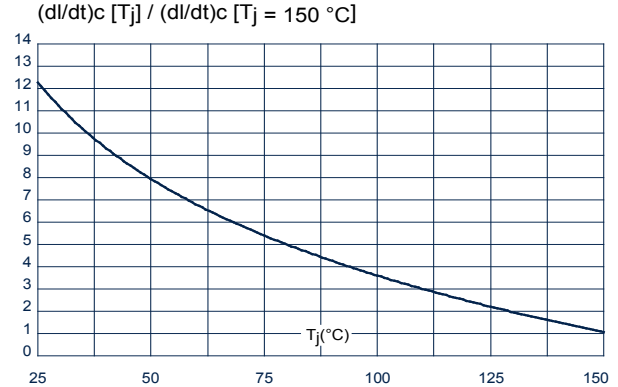

Figure 9. Non repetitive surge peak on-state current for a sinusoidal pulse with width $t_p < 10$ ms

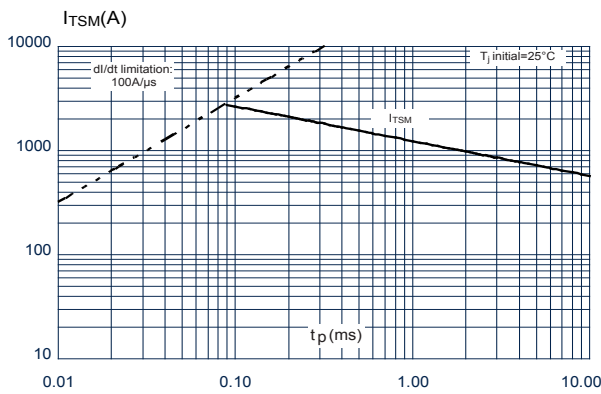

Figure 10. Surge peak on-state current versus number of cycles

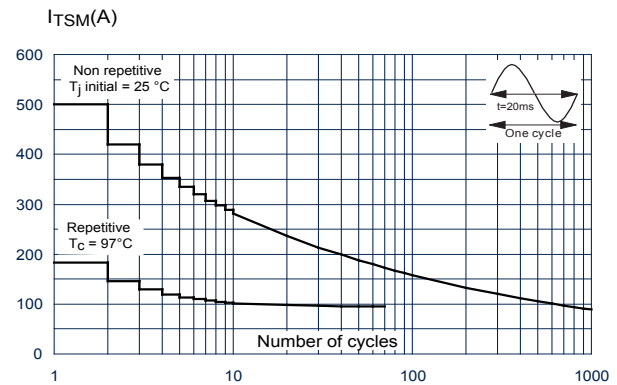

Figure 11. Relative variation of critical rate of decrease of main current (dl/dt)c versus reapplied dV/dt (typical values)

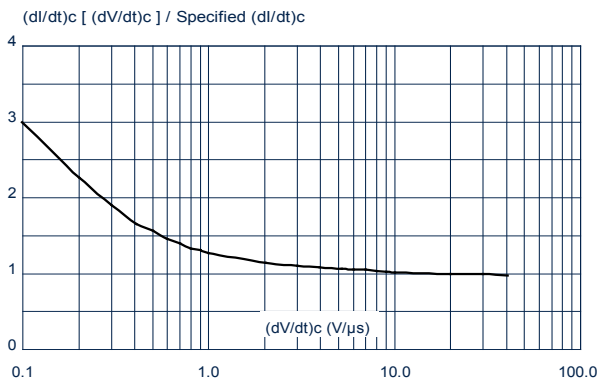

Figure 12. Relative variation of thermal impedance versus reappplied pulse duration

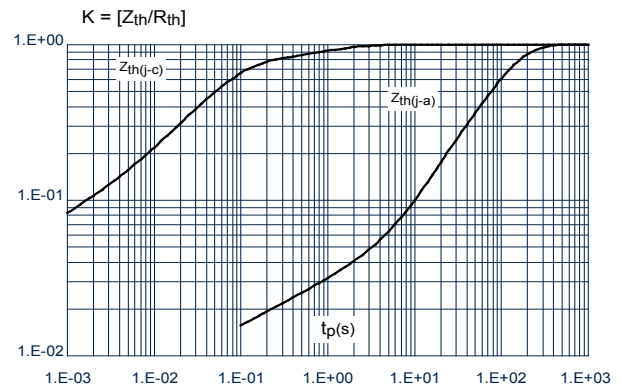

Figure 13. Relative variation of leakage current versus junction temperature for different values of blocking voltage (typical values)

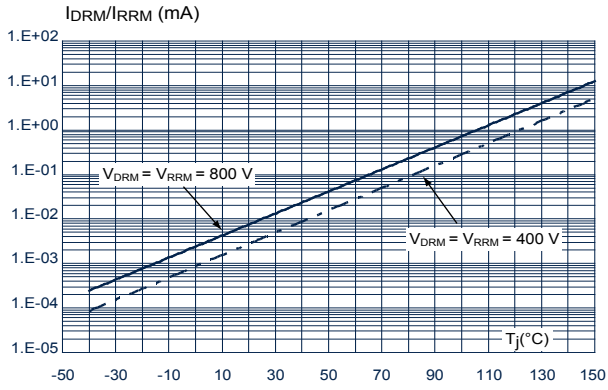
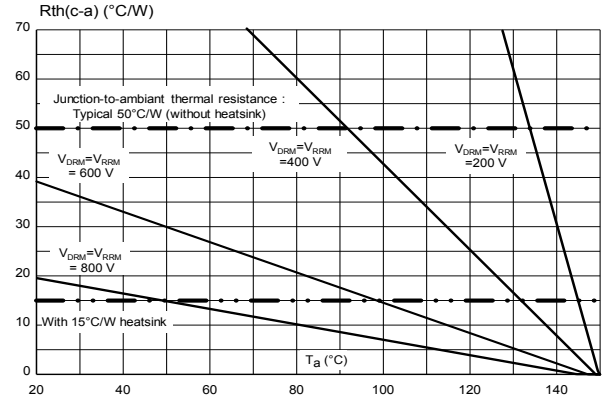

Figure 14. Recommended maximum case-to-ambient thermal resistance versus ambient temperature for different peak off-state voltages



2 Package information

In order to meet environmental requirements, ST offers these devices in different grades of **ECOPACK** packages, depending on their level of environmental compliance. ECOPACK specifications, grade definitions and product status are available at: www.st.com. ECOPACK is an ST trademark.

2.1 Package information

- **ECOPACK** (lead-free plating and halogen free package compliance)
- Lead-free package leads finishing
- Halogen-free molding compound resin meets UL94 standard level V0
- Recommended torque: 1.05 N·m (max. torque: 1.2 N·m)

Figure 15. Package outline

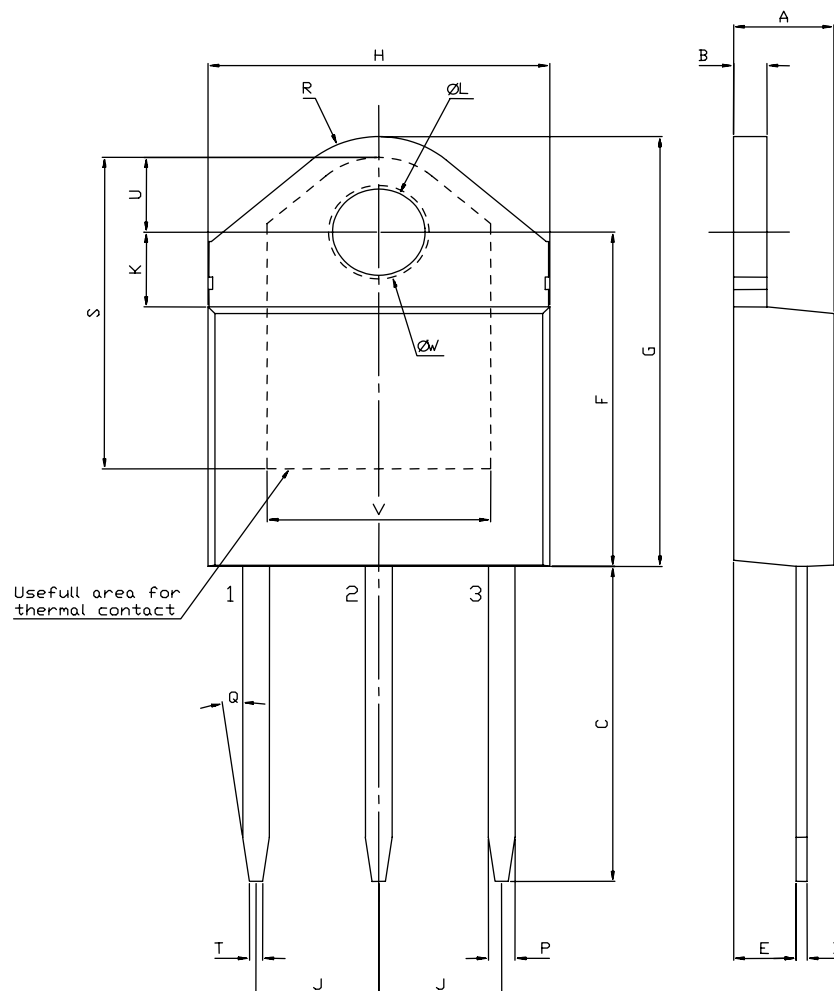

Table 5. Mechanical data

Ref.	Dimensions					
	mm			Inches ⁽¹⁾		
	Min.	Typ.	Max.	Min.	Typ.	Max.
A	4.40		4.60	0.1732		0.1811
B	1.45		1.55	0.0571		0.0610
C	14.35		15.60	0.5650		0.6142
D	0.50		0.70	0.0197		0.0276
E	2.70		2.90	0.1063		0.1142
F	15.80		16.50	0.6220		0.6496
G	20.40		21.10	0.8031		0.8307
H	15.10		15.50	0.5945		0.6102
J	5.40		5.65	0.2126		0.2224
K	3.40		3.65	0.1339		0.1437
L	4.08		4.17	0.1606		0.1642
P	1.20		1.40	0.0472		0.0551
R		4.60			0.1811	

1. Inches given for reference only

3 Ordering information

Figure 16. Ordering information scheme

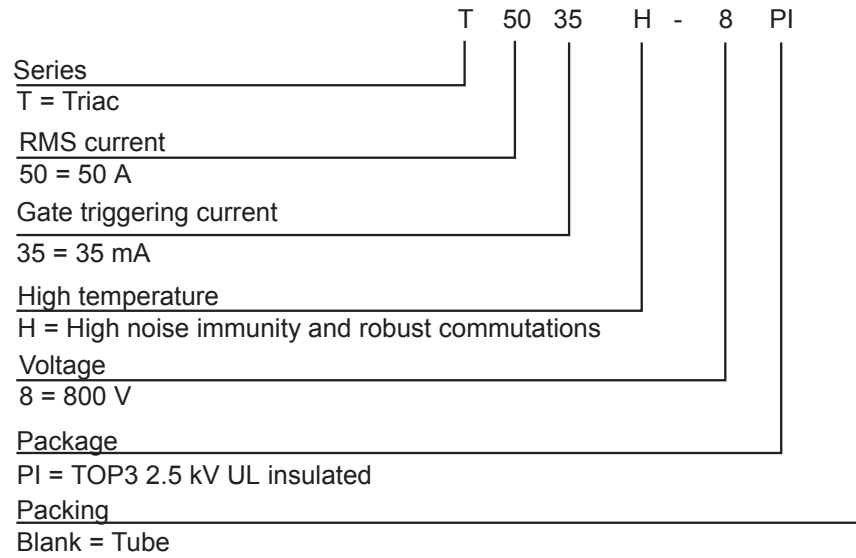

Table 6. Ordering information

Order code	Marking	Package	Weight	Base qty.	Delivery mode
T5035H-8PI	T5035H-8PI	TOP3 Ins.	4.5 g	30	Tube

Revision history

Table 7. Document revision history

Date	Revision	Changes
05-Oct-2021	1	Initial release.