

THE WORLD OF VAC CURRENT SENSORS



ADVANCED MAGNETIC SOLUTIONS

VAC[®]
VACUUMSCHMELZE



THE COMPANY **VACUUMSCHMELZE**

ADVANCED MAGNETIC SOLUTIONS

VACUUMSCHMELZE (VAC) is a leading manufacturer of magnetic materials and solutions. We passionately advance the technologies of today and tomorrow. As a reliable partner, we work with our customers to develop application solutions that make it possible to meet constantly increasing requirements. We push technical boundaries with groundbreaking solutions.

The use of our materials as well as our refined solutions and their special magnetic properties are the key to making our customers' systems smaller, lighter, more efficient and, last but not least, safer. Thereby we contribute significantly to the saving of resources and the protection of our environment.

THE COMPANY

VACUUMSCHMELZE

We are an internationally operating company with headquarters in Hanau, Germany. With approximately 4,300 employees worldwide, the company is represented in more than 40 countries and currently achieves a turnover of approximately EUR 400 million.

CONTENTS

1. Technical information	Page 4-6
2. Active current sensors for PCB mounting	Page 7-15
3. Active current sensors with primary conductor opening	Page 16-22
4. Maximum accuracy current sensors for panel mounting	Page 23-30
5. All-current sensitive differential current sensors	Page 31-44
6. benvac Differential current sensor for IC-CPD (In-Cable Control and Protection Device) and wallbox applications	Page 45-51
7. Key to part numbers	Page 52
8. Cross-reference-list VAC – LEM	Page 53-54

TECHNICAL INFORMATION

FUNCTIONAL PRINCIPLE OF THE VAC CLOSED LOOP CURRENT SENSORS

The current I_p to be measured generates a flux in the soft magnetic core. The sensor electronics generates a flux in the opposite direction via the compensation current I_s and controls the sum of the fluxes to zero. This is done by means of a magnetic field probe, which is located in the air gap of the core. At frequencies above a few kHz, the magnetic system consisting of the primary winding, the magnetic core and the secondary winding functions independently of the electronics as a current transformer. The compensating current corresponds in amount and shape to the primary current divided by the number of turns of the secondary winding. A voltage can be derived from the measuring resistor. The main advantages of the closed loop current sensors are their high measuring accuracy, as well as their low rise time and wide bandwidth. VAC closed loop sensors with magnetic probe achieve an even higher accuracy over the entire application temperature range than their counterparts with Hall element.

CURRENT SHAPES

The operating currents to be measured in the power electronics are, as a rule, direct currents or alternating currents up to a maximum of a few 100 Hz with a high amplitude. They are superimposed by the switching currents of the power semiconductors, which reach into the single to double-digit kHz range and have harmonics up to the three-digit range. Their amplitude is significantly lower. Our current sensors are designed for this type of current. If the amplitude of high frequency components is permanently much greater, an excessive heating of the sensor core may occur. So, apart from the level of the current to be measured, its shape also has an influence on the losses and thus the heating of the sensor.

POSITIONING OF THE PRIMARY CONDUCTOR IN CURRENT SENSORS WITH A PRIMARY OPENING

In compensation sensors, a magnetic flux generated by the primary current is detected in the sensor core and compensated for by an equally large flux of reversed polarity. Although our sensors are magnetically very robust in design, the optimal function of this measuring principle is not completely independent of the position of the conductor in the magnetic circuit, or of the position of external current-carrying conductors relative to the magnetic circuit and the zero-field probe sensor. Also of importance are the amplitude and frequency of the current. The resultant influence can affect the dynamic characteristics of the sensor, the measuring accuracy at high levels and possibly heating. The best results are achieved if the conductor is put centrally through the sensor opening and the immediate area around the current sensor is kept free of conductors carrying high currents. More information is available on request.

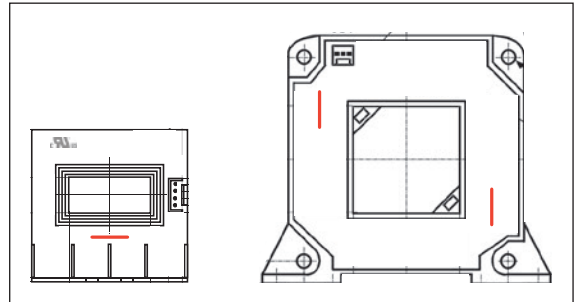

Location of the magnetic probes in the sensor families N4648-X0xx und P4640-X1xx

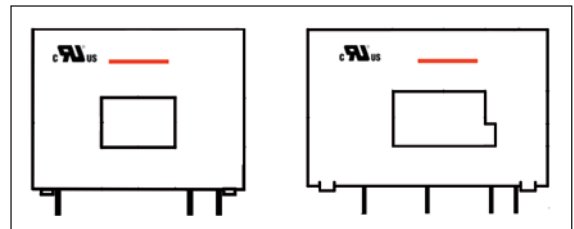

Location of the magnetic probes in the sensor families N464&-X1xx and N4646-x2xx

CONDUCTED AND RADIATED EMISSIONS

Under very unfavourable conditions, there may be an influence on the sensor by irradiation from interference signals. Low or medium-frequency interference is due to magnetic fields, for example from power chokes or transformers. High-frequency interference, usually in the range of several hundred MHz, can be injected directly into the sensor or via the connecting leads. Whether a possible high-frequency effect on the current sensor has practical consequences for the application depends on the design of, for example, the shielding of the housing. The VAC current sensors from the various series are successively tested for electromagnetic compatibility according to IEC 61000-4-3: 2010. Please contact us to inquire on the current status of the tests.

THE "OFFSET RIPPLE"

Due to the principle of VAC sensors, the remnant of the internal probe signal is not completely suppressed. The frequency of this signal is 400 kHz or more. It is zero symmetrical and does not affect the measurement accuracy when integrated over at least one period. In addition, it can be further reduced with a simple low pass filter (capacitor parallel to the measuring resistor). The so-called "offset ripple" i_{OSS} shown in our data sheets is actually not an offset.

REFERENCE VOLTAGE V_{REF} IN/OUT

Optionally the reference pin V_{ref} can be used as input or output. Thereby the internally generated reference REF_{OUT} can be routed as output or an external reference REF_{IN} can be connected as input to the sensor. It is recommended to evaluate the output voltage V_{OUT} differentially against the precise reference connected at the REF_{OUT} output and not against GND. Doing so, lowest offset values of the current sensor can be achieved.

ADDITIONAL INFORMATION FOR DIFFERENTIAL CURRENT SENSORS ONLY

ADDITIONAL FUNCTION DEMAGNETIZATION

The sensor will automatically perform a demagnetization cycle at every power up and is ready for use after approximately 150 ms. It is recommended to perform a demagnetization periodically during the operation of the sensor. This will ensure that any potentially remaining magnetization of the compensation core will be eliminated and the measuring accuracy and offset are in the optimum range.

To perform a demagnetization cycle, please proceed as follows:

- V_{REF} must be set to 0V for $> 100 \mu s$; start of internal test-current generation
- once V_{REF} is reset to its reference values, demagnetization will begin
- sensor runs a 110 ms demagnetization cycle
- during this period the output is set to $V_{OUT} < 0,5V$
- afterwards the sensor is ready for use

INTERNAL TEST-CURRENT GENERATION

As soon as V_{REF} is set to 0V, the current sensor will generate a test-current while a constant output $V_{out} = 250 mV$ appears. This function can be used, to verify correct functionality of the sensor.

EXTERNAL TEST-CURRENT GENERATION

Most of the shown sensors of the N4646 series offer additional connections for external test-current generation. Inside the sensor a separate winding is placed on the magnetic module and fed to the outside. It is recommended to apply a sufficiently high external current to verify correct functionality and, if necessary, the intended switch-off threshold.

STANDARDS AND REGULATIONS

Our sensors are designed according to IEC 61800-5-1 “Adjustable speed electrical power drive systems”. However, the sensors also meet many claims of other standards, such as EN 50178 “Electronic equipment for use in power installations” or EN 62109 “Safety of power converters for use in photovoltaic power systems”. Furthermore, our standard types are certified by Underwriters Laboratories according to UL508, “Industrial Control Equipment”. The category is NMTR2 (Component – Power Circuit and Motor – mounted Apparatus). VAC sensors can be found in the Files E317483 and E169721.

VALIDATION AND TYPE TESTING

All newly created series are subjected to extensive type testing and validation. The criteria of the type tests are described in our data sheets under the headings “Electrical data: (investigated by type testing)” and “Routine tests”. The validation includes placement in damp climate, alternating temperatures in damp climate, rapid temperature changes, repeated on/off cycles, sinusoidal vibration, continuous shock, solderability and resistance to solder heat tests.

ROHS AND REACH

The products described in this brochure contain no hazardous substances pursuant to the relevant ban lists, such as RoHS, REACH, WEE, ECHA, JIG, GADSL and others.

ACTIVE CURRENT SENSORS FOR PCB MOUNTING



VAC offers several series of active current sensors for print mounting in which the primary conductor is integrated. The electronics of the new VAC current sensors are almost completely concentrated in a novel IC developed jointly with a leading semiconductor manufacturer. Despite the compact design, all types offer the detection of high maximum and continuous currents.

TYPICAL APPLICATIONS

- frequency converters for drives
- photovoltaic inverters
- wind power converters
- charging stations for e-mobility
- welding inverters
- switched mode power supplies
- robotics

TYPICAL PROPERTIES

- closed-loop current sensors with the VAC-invented magnetic probe as zero field detector
- standard series for nominal currents from 6 to 100 A and peak currents up to ± 200 A in compact designs
- types for + 5 Volt power supply with voltage output
- types for $\pm 12 \dots 15$ Volt power supply with current output
- very good measuring accuracy, minimum DC offset with very low hysteresis

- negligible output noise
- very low temperature dependence and long-term drift of the output variable
- low rise time, wide frequency range
- cost-effective construction
- dimensions and pinning compatible to common industry standards

NEW ASIC: SERIES ...4648-X...

A newly developed ASIC contains most of the electronics for the ± 12 , ± 15 or ± 24 Volt-powered sensors with current output. The new sensors are available under the family designation T60404-N4648 - X They are fully compatible with previous models.

EMC IMPROVED SERIES ...4647-X...



We offer a new series with increased electromagnetic compatibility under the family designation T60404-N4647-Xxxx. The current sensors have additional measures for improvement of the EMC. They are fully compatible with the corresponding types 4646. For new applications we recommend the EMC optimized series 4647.

TYPE SERIES OF VAC CURRENT SENSORS

Item no. Type T60404-N...		Rated current $I_{PN, rms} @ K_N = 1:N$ [A]	Max. measuring range $I_{Pmax} @ V_C = +5V \text{ or } V_C = \pm 15V$ [A]	Turns ratio K_N	Output variable	V_{ref} -input/output ²	Ambient temperature range T_{amb} [°C] -40 to	Supply voltage V_C [V]	Creepage/clearance [mm]	System/working voltage acc. to EN 61800-5-1 (reinforced insul.; insul. mat. group 1; PD 2; OV 3) [V]	Frequency range f [kHz] DC to	Accuracy $X @ I_{PN}; T_{amb} = 25^\circ C$ [%]	Mechanical outline
	4646-X653	6 3 2	±20 ±10 ±7	1:2000 2:2000 3:2000	U		+85	+5	7/7	300/650	200	0.7	1
	4646-X652	15 7,5 5	±51 ±25 ±17	1:2000 2:2000 3:2000	U		+85	+5	7/7	300/650	200	0.7	1
	4646-X651	25 12 8	±85 ±42 ±28	1:2000 2:2000 3:2000	U		+85	+5	7/7	300/650	200	0.7	1
	4646-X654	50 12 8	±150 ±75 ±50	1:1400 2:1400 3:1400	U		+85	+5	7/7	300/650	200	0.7	1
	4646-X663 ¹ 4647-X663 ¹	6 3 2	±20 ±10 ±7	1:2000 2:2000 3:2000	U	yes	+85	+5	7/7	300/650	200	0.7	2
	4646-X662 ¹ 4647-X662 ¹	15 7,5 5	±51 ±25 ±17	1:2000 2:2000 3:2000	U	yes	+85	+5	7/7	300/650	200	0.7	2
	4646-X661 ¹ 4647-X661 ¹	25 12 8	±85 ±42 ±28	1:2000 2:2000 3:2000	U	yes	+85	+5	7/7	300/650	200	0.7	2
	4646-X664 ¹ 4647-X664 ¹	50 12 8	±150 ±75 ±50	1:1400 2:1400 3:1400	U	yes	+85	+5	7/7	300/650	200	0.7	2

¹ Reference voltage output $2.5 \pm 0.005V$. $R_i = 670 \text{ Ohm}$. Can be overwritten and therefore used as an input for an external reference. Voltage range 0 ... 4V.

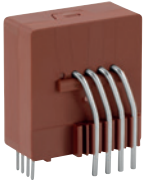
² Current sensor is red-phosphorus-free

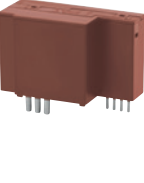
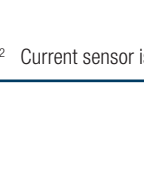
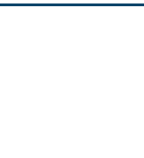
Item no. Type T60404-N...		Rated current $I_{PN, rms} @ K_N = 1:N$ [A]	Max. measuring range $I_{Pmax} @ V_C = +5V \text{ or } V_C = \pm 15V$ [A]	Turns ratio K_N	Output variable	V_{ref} -input/output ²	Ambient temperature range T_{amb} [°C] -40 to	Supply voltage V_C [V]	Creepage/clearance [mm]	System/working voltage acc. to EN 61800-5-1 (reinforced insul.; insul. mat. group 1; PD 2; OV 3) [V]	Frequency range f [kHz] DC to	Accuracy $X @ I_{PN}, T_{amb} = 25^\circ C$ [%]	Mechanical outline
	4646-X763 ^{1,2}	6	±20	1:2000	U	yes	+85	+5	9.6/10.6	600/1060	200	0.7	3
	4647-X763 ^{1,2}	3	±10	2:2000									
	4647-X763 ^{1,2}	1,5	±5	4:2000									
	4646-X762 ^{1,2}	15	±51	1:2000									
	4647-X762 ^{1,2}	7,5	±25,5	2:2000	U	yes	+85	+5	9.6/10.6	600/1060	200	0.7	3
	4647-X762 ^{1,2}	3,75	±12,5	4:2000									
	4646-X761 ^{1,2}	25	±85	1:2000									
	4647-X761 ^{1,2}	12	±42	2:2000									
	4647-P765 ²	75	±182	1:1100	U	ja	+85	+5	7,5/7,5	300/750	200	0,7	4
	4647-P765 ²	6	±21	4:2000									
	4646-X764 ^{1,2}	50	±150	1:1400									
	4647-X764 ^{1,2}	12	±75	2:1400									
	4646-X460 ¹	50	±150	1:1400	U	yes	+85	+5	10.2/10.2	600/1020	100	0.7	5
	4647-X460 ¹	25	±75	2:1400									
	4647-X460 ¹	17	±50	3:1400									
	4646-X461 ¹	100	±200	1:1100									
	4647-X461 ¹	50	±100	2:1100	U	yes	+85	+5	10.2/10.2	600/1020	100	0.7	5
	4647-X461 ¹	33	±66	3:1100									

The following applies to all current sensors with +5 V supply voltage: $V_A = V_{ref} \pm (0.625 \cdot I_P / I_{PN})$, resp. $V_A = 2.5 V \pm (0.625 \cdot I_P / I_{PN})$.

Examples, type 4646-X761: $I_P = +20$ A DC

$$U_A = 2.5 V + 0.625 \times 20 A / 25 A = 2.5 V + 0.5 V$$

² Current sensor is red-phosphorus-free

Item no. Type T60404-N...		Rated current $I_{PN, rms} @ K_N = 1:N$ [A]	Max. measuring range $I_{Pmax} @ V_C = +5V$ or $V_C = \pm 15V$ [A]	Turns ratio K_N	Output variable	V_{ref} -input/output ²	Ambient temperature range T_{amb} [°C] -40 to	Supply voltage V_C [V]	Creepage/clearance [mm]	System/working voltage acc. to EN 61800-5-1 (reinforced insul.; insul. mat. group 1; PD 2; OV 3) [V]	Frequency range f [kHz] DC to	Accuracy $X @ I_{PN}; T_{amb} = 25 °C$ [%]	Mechanical outline
	4646-X300	25 12 8	±85 ±43 ±28	1:1000 2:1000 3:1000	I	+85	±12 ... 15	10.2/10.2	600/1020	200	0.5	6	
	4648-X300	6 5	±21 ±17	4:1000 5:1000									
	4646-X400	25 10	±130 ±65	1:1000 2:1000	I	+85	±12 ... 15	10.2/10.2	600/1020	200	0.5	7	
	4648-X400	8	±43	3:1000									
	4646-X410	50 20 15	±128 ±64 ±43	1:1000 2:1000 3:1000	I	+85	±12 ... 15	10.2/10.2	600/1020	200	0.5	8	
	4646-X412	100 35 25	±175 ±82 ±58	1:2000 2:2000 3:2000	I	+85	±12 ... 15	10.2/10.2	600/1020	200	0.5	8	
	4646-X413	100 35 25	±208 ±104 ±69	1:1500 2:1500 3:1500	I	+85	±12 ... 15	10.2/10.2	600/1020	200	0.5	8	

The following applies to all current sensors with +5 V supply voltage: $V_A = V_{ref} \pm (0.625 \cdot I_P / I_{PN})$, resp. $V_A = 2.5 V \pm (0.625 \cdot I_P / I_{PN})$.

Examples, type 4646-X761: $I_P = +20$ A DC

$$U_A = 2.5 V + 0.625 \times 20 A / 25 A = 2.5 V + 0.5 V$$

MECHANICAL OUTLINES

Drawing no. 1



Type

T60404-N4646-X651
T60404-N4646-X652
T60404-N4646-X653
T60404-N4646-X654



Drawing no. 2



Type

T60404-N4646-X661 / 7-X661
T60404-N4646-X662 / 7-X662
T60404-N4646-X663 / 7-X663
T60404-N4646-X664 / 7-X664

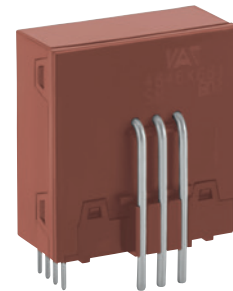

Photos for illustration purposes only

Drawing no. 3



○ Prüfmaß

Toleranz der Stiftabstände ±0,25mm

Type

- T60404-N4646-X761 / 7-X761
- T60404-N4646-X762 / 7-X762
- T60404-N4646-X763 / 7-X763
- T60404-N4646-X764 / 7-X764

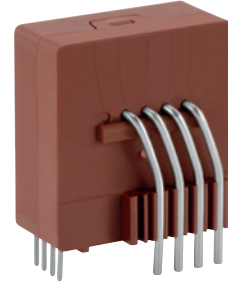

Drawing no. 4



○ Test dimension

Tolerance of pin distances ±0,25mm

DC= Date Code
F = Factory

Type

- T60604-N4647-P765



Photos for illustration purposes only

Drawing no. 5



Toleranz der Stiftabstände ±0,2mm

Type

T60404-N4646-X460 / 7-X460

T60404-N4646-X461 / 7-X461

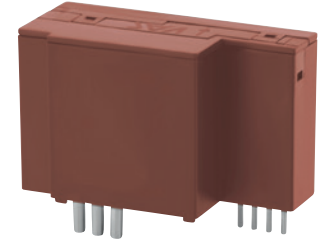

DC = Date Code
F = Factory

Photos for illustration purposes only

Drawing no. 6

Type

T60404-N4646-X300 / 8-X300

Toleranz der Stiftabstände $\pm 0,3\text{mm}$

DC = Date Code
F = Factory

Ziffern 1 - 13 nicht aufgedruckt



Drawing no. 7

Type

T60404-N4646-X400 / 8-X400

Toleranz der Stiftabstände $\pm 0,2\text{mm}$



DC = Date Code
F = Factory

Photos for illustration purposes only

Drawing no. 8



Toleranz der Stiftabstände
±0,2mm

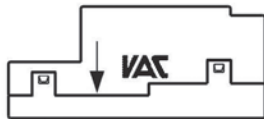
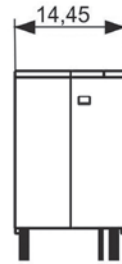
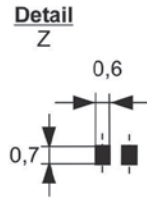

DC = Date Code
F= Factory

Type

T60404-N4646-X410

T60404-N4646-X412

T60404-N4646-X413

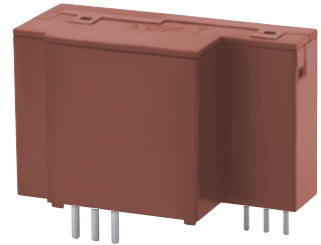

Photos for illustration purposes only

ACTIVE CURRENT SENSORS WITH PRIMARY CONDUCTOR OPENING

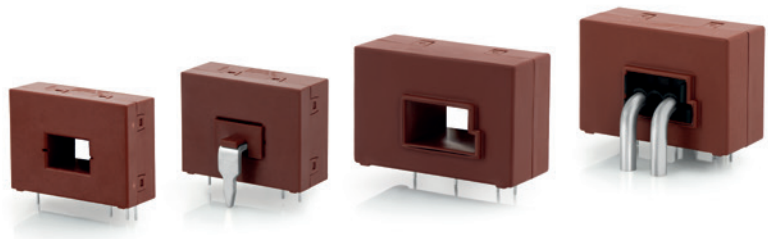

VAC offers several series of active current sensors for print mounting in which the primary conductor is put through. The electronics of the new VAC current sensors are almost completely concentrated in a novel IC developed jointly with a leading semiconductor manufacturer. Despite the compact design, all types offer the detection of high maximum and continuous currents.

TYPICAL APPLICATIONS

- frequency converters for drives
- photovoltaic inverters
- wind power converters
- charging stations for e-mobility
- welding inverters
- switched mode power supplies
- robotics

TYPICAL PROPERTIES

- closed-loop current sensors with the VAC-invented magnetic probe as zero field detector
- standard series for nominal currents from 50 to 200 A and peak currents up to ± 390 A in compact designs
- types for + 5 Volt power supply with voltage output
- types for $\pm 12 \dots 15$ Volt power supply with current output

- very good measuring accuracy, minimum DC offset with very low hysteresis
- negligible output noise
- very low temperature dependence and long-term drift of the output variable
- low rise time, wide frequency range
- cost-effective construction
- dimensions and pinning compatible to common industry standards

MEASUREMENT OF HIGHEST CURRENTS WITH A UNIPOLAR +5 VOLT POWER SUPPLY VOLTAGE

The types T60404-N4647-X260 (through-version), or X261 (with primary conductors) detect maximum continuous rms currents up to 150 A and peak currents up to ± 270 A and require only a simple 5 Volt power supply. They are suitable e.g. for solar inverters of higher power, where only a unipolar +5 V power supply is integrated.

EMC-IMPROVED SENSOR TYPES

Our current sensors offer a high ESD. We also offer new series with increased electromagnetic compatibility under the family designation T60404-N4647-Xxxx.

TYPE SERIES OF ACTIVE CURRENT SENSORS WITH PRIMARY CONDUCTOR OPENING

Item no. Type T60404-N...	Rated current $I_{PN, rms} @ K_N = 1 : N$ [A]	Max. measuring range $I_{Pmax} @ V_C = +5V \text{ or } V_C = \pm 12 \dots 15V$ [A]	Ambient temperature range T_{amb} [°C] -40 to	Supply voltage V_C [V]	Turns ratio $K_N = 1 :$	Output variable	Frequency range f [kHz] DC to	Max. error $X @ I_{PN} T_{amb} = 25^\circ C$ [%]	Primary Connection		Secondary Connection Pins	Integrated Electronics	Dimensional diagrams
									Conductor	Opening			
 4646-X100	100	± 235 ± 180	+85	± 12 ± 15	1000	I	200	0.5		•	•	•	1
 4646-X111	100	± 188 ± 236	+85	± 12 ± 15	2000	I	200	0.5	•		•	•	2
 4646-X101	100	± 188 ± 236	+85	± 12 ± 15	2000	I	200	0.5		•	•	•	1
 4646-X112	100	± 235 ± 180	+85	± 12 ± 15	1000	I	200	0.5	•		•	•	2
 4646-X160 4647-X160	100	± 230	+85	+5	1000	U	100	1.0		•	•	•	3
 4646-X161 4647-X161	50	± 172	+85	+5	1000	U	100	1.0		•	•	•	3

Item no. Type T60404-N...		Rated current $I_{PN,rms} @ K_N = 1:N$	Max. measuring range $I_{Pmax} @ V_C = +5V$ or $V_C = \pm 12...15V$	Ambient temperature range T_{amb}	Supply voltage V_C	Turns ratio $K_N = 1:$	Output variable	Frequency range f	Max. error $X @ I_{PN} T_{amb} = 25^\circ C$	Conductor Opening	Primary Connection	Secondary Connection	Integrated Electronics	Dimensional diagrams
		[A]	[A]	[°C] -40 to	[V]			[kHz] DC to	[%]			Pins		
	4646-X200	125	± 201 ± 214	+85	± 12 ± 15	1000	I	100	0.5		•	•	•	4
	4646-X201	200	± 305 ± 390	+85	± 12 ± 15	2000	I	100	0.5		•	•	•	4
	4647-X260	150	± 270	+85	+5	1100	U	100	0.7		•	•	•	5
	4647-X261	100 (150)	± 270	+85	+5	1100	U	100	0.7	•		•	•	6
	4647-X262	150	± 270	+85	+5	1100	U	100	0,7	•		•	•	7
	4647-X263	150	± 450	+85	+12	1550	U	100	0,7	•		•	•	7
	4647-X264	150	± 450	+85	+12	1550	U	100	0,7	•		•	•	5

Abbreviations
and terms

$I_{PN,rms}$	[A]	primary rated current	K_N	turns ratio
I_{Pmax}	[A]	maximum measuring range	f	[kHz] frequency range
T_A	[°C]	ambient temperature	X	[%] accuracy
V_C	[V]	supply voltage		

The following applies to all current sensors with +5 V supply voltage:

$$V_A = V_{ref} \pm (0.625 * I_p / I_{PN}), \text{ resp. } V_A = 2.5V \pm (0.625 * I_p / I_{PN}).$$

Examples, type 4646-X761: $I_p = +20$ A DC

$$U_A = 2,5 V + 0,625 \times 20 A / 25 A = 2,5 V + 0,5 V$$

MECHANICAL OUTLINES

Drawing no. 1

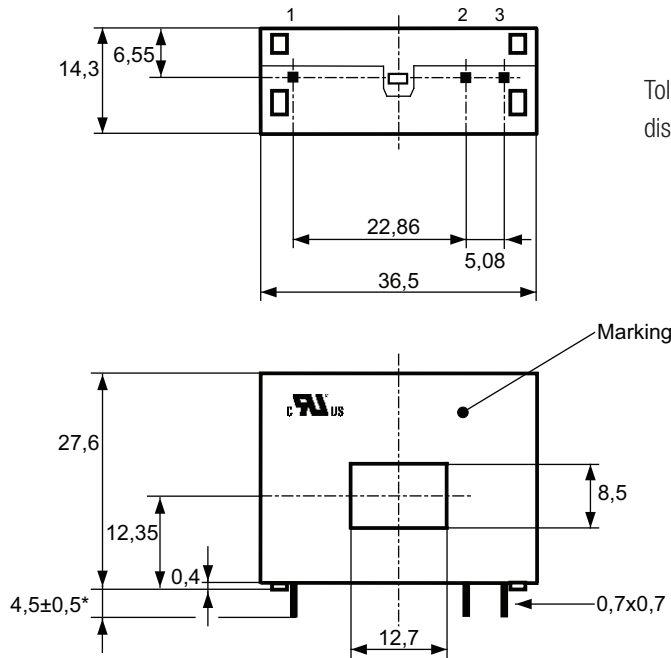

Tolerances grid
distance ± 0.2 mm

Type

T60404-N4646-X100 and ...X101

Connections:

1 ... 3: 0.7 x 0.7 mm

Pin Assignments:

- 1: $+V_C$
- 2: $-V_C$
- 3: I_S

Drawing no. 2

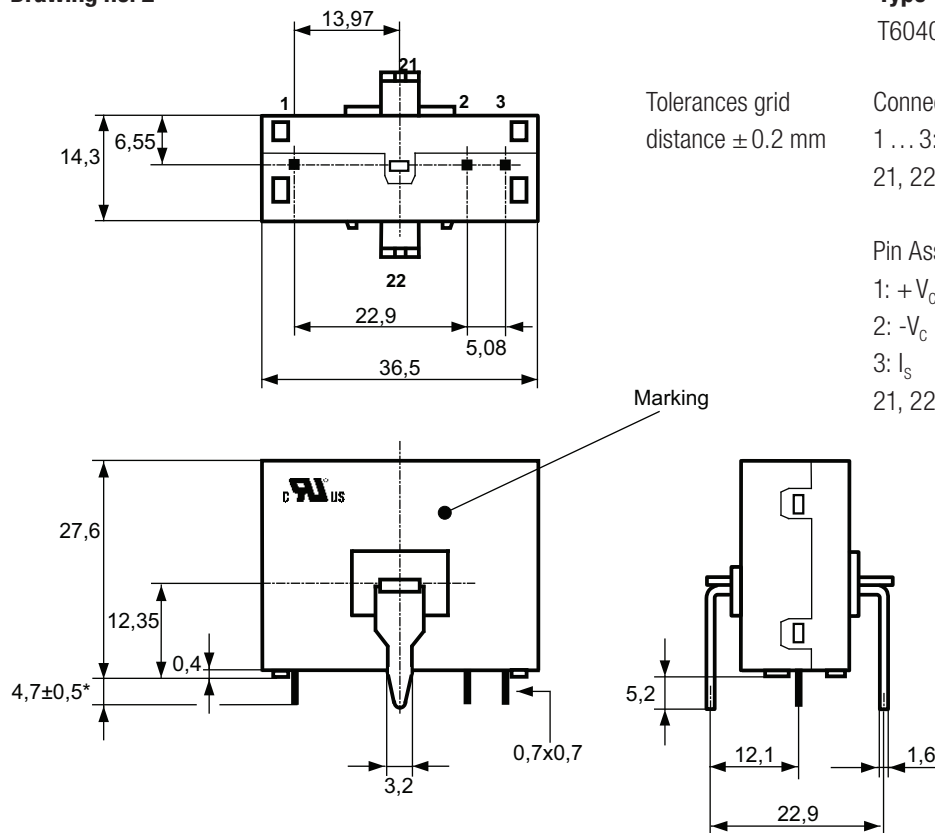

Tolerances grid
distance ± 0.2 mm

Type

T60404-N4646-X111 and ...X112

Connections:

1 ... 3: 0.7 x 0.7 mm
21, 22: 3.2 x 1.6 mm

Pin Assignments:

- 1: $+V_C$
- 2: $-V_C$
- 3: I_S
- 21, 22: I_P

Drawing no. 3

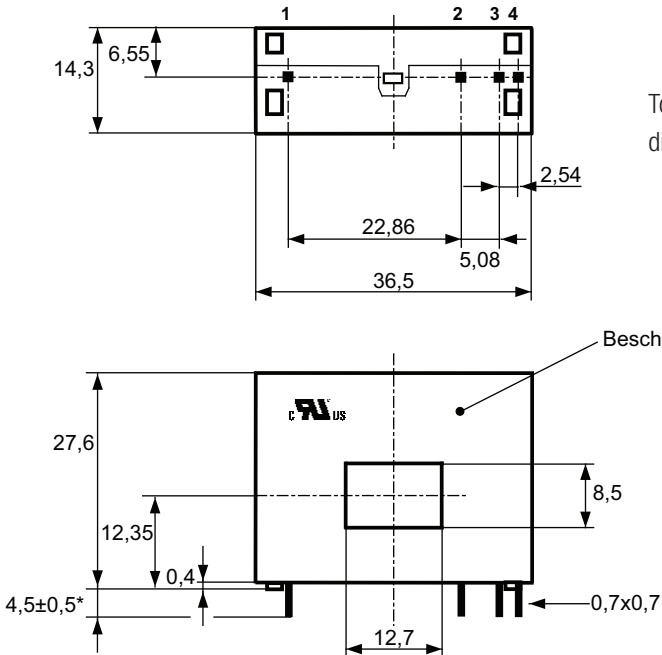

Tolerances grid
distance ± 0.2 mm

Type

T60404-N4646-X160 and ...X161
T60404-N4647-X160 and ...X161

Connections:

1 ... 4: 0.7 x 0.7 mm

Pin Assignments:

- 1: $+V_C$
- 2: earth
- 3: V_{OUT}
- 4: V_{REF} in/out

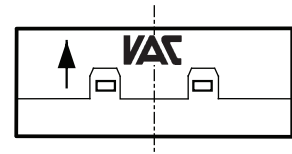

Drawing no. 4



Tolerances grid
distance ± 0.2 mm

Type

T60404-N4646-X200 and ...X201

Connections:

1 ... 3: 0.6 x 0.88 mm

Pin Assignments:

- 1: $-V_C$
- 2: I_S
- 3: $+V_C$
- 4: n.c.



Drawing no. 5



Type

T60404-N4647-X260 and ...X264

Tolerances grid
distance ± 0.2 mm

Connections:
1 ... 4: 0.66 x 0.88 mm

Pin Assignments:

- 1: V_C
- 2: earth
- 3: V_{out}
- 4: V_{ref} in/out



Drawing no. 6



Type

T60404-N4647-X261

Tolerances grid
distance ± 0.2 mm

Connections:
1 ... 4: 0.66 x 0.88 mm
5 ... 8: $\varnothing 4.5$ mm

Pin Assignments:

- 1: V_C
- 2: earth
- 3: V_{out}
- 4: V_{ref} in/out



Drawing no. 7



Tolerances grid
distance ± 0.2 mm

Type

T60404-4647-X262 und ...X263

Connections:

1 ... 4: 0.66×0.88 mm
5 ... 10: $\varnothing 4,5$ mm

Pin Assignments:

- 1: V_C
- 2: earth
- 3: V_{OUT}
- 4: V_{REF} in/out

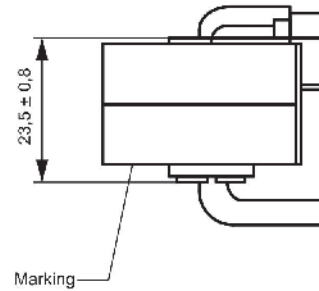

\varnothing Prüfmaß
(test dimension)

MAXIMUM ACCURACY CURRENT SENSORS FOR PANEL MOUNTING



VAC is the technology leader in DC and AC current sensing, providing a wide range of products to the industry. VAC owns state of the art R&D facilities and worldwide manufacturing sites, offering outstanding product quality.

Major applications for the VAC current sensors are variable speed drives, photovoltaic inverters, welding inverters, wind power turbines. The detectable currents range from a few amperes to more than 2000 amperes. Our differential current sensors measure even in the milliamperere range

If the current of the application is at several 100A or in the four digit range, the current sensor is mounted on the equipment chassis and the supply and signal connections are contacted via plug.

The VAC model series in this segment are designed for maximum rated currents from 500 to 1000 A with measuring ranges up to 2500 A. They operate from a symmetrical voltage supply with usually ± 15 volts or ± 24 volts. The output signal is a current.

The VAC-invented measuring principle of the closed-loop sensor with magnetic probe as a zero field detector is distinguished by maximum precision of the current detection. It is usually very good and by far better than any open loop sensor.

TYPICAL PROPERTIES

- very good accuracy (gain error typ. 0.1 %). Minimum DC-offset and hysteresis
- negligible temperature drift, excellent long-term stability of the output (typ. 0.1 % over the temperature range $-40 \dots +85 \text{ }^\circ\text{C}$)
- insignificant output noise
- low rise time (typ. < 0.5 microseconds), wide frequency range (e.g., DC to 100 kHz or 200 kHz)
- high operational safety, i.e. recovery after clipping, or power supply failure
- great robustness against HV transients, pulse currents, ESD, external DC or AC fields
- high reliability by electronics largely realized in application specific integrated circuits
- cost-effective design, mass production on highest qualitative level
- dimensions and pinning compatible to common industry standards
- relevant international standards are met, UL approved

TYPE SERIES OF VAC CURRENT SENSORS

VAC Item no. Typ T60404-...		Rated current $I_{PN, rms} @ K_N = 1 : N$	Max. measuring range $I_{Pmax.} (@ V_C = \pm 15V$ or $\pm 24V$ $V; T_{A,max}) @ R_{meas}$	Ambient temperature range T_A	Turns ratio K_N	Supply voltage V_C	Frequency range f	
		[A]	[A] @ [Ω]	[°C] -40 to		[V]	[kHz] DC to	
	N4648-X052	500	$\pm 700 @ 10$	+85	1:2000	± 15	50	
	N4648-X053	500	$\pm 700 @ 10$	+85	1:2000	± 15	50	
	N4648-X054 ¹	700 400 250	$\pm 1250 @ 10$	+70 +85 +105	1:3000	± 15	50	
	N4644-X056	500	$\pm 1000 @ 10$	+75	1:3000	± 24	50	
	P4640-X100	1000	$\pm 1340 @ 10$	+85	1:5000	± 15	100	
	P4640-X101	1000	$\pm 1340 @ 10$	+85	1:5000	± 15	100	
	P4640-X102	1000	$\pm 1340 @ 10$	+85	1:5000	± 15	100	
	P4640-X150	1000	$\pm 2150 @ 10$	+85	1:5000	± 24	100	
	P4640-X151	1000	$\pm 2150 @ 10$	+85	1:5000	± 24	100	
	P4640-X152	1000	$\pm 2150 @ 10$	+85	1:5000	± 24	100	
	P4640-X156	1000	$\pm 2150 @ 10$	+85	1:5000	± 24	100	
	P4640-X256	1700	$\pm 2750 @ 1$	+85	1:5000	± 24	100	

Remarks

The output variable of these types is always a current.

¹ This type has a differential output whose potential changes depending on the signal polarity. To establish a ground reference, it is imperative to put an external differential amplifier behind it.

² EN 61800-5-1, reinforced insulation, insulation material group 1, pollution degree 2, overvoltage category 3

³ clearance and creepage distances, voltage potential difference according to UL508, Table 36.1.

	Creepage/ clearance [mm]	System/working voltage acc. to EN 61800-5-1⁴ Voltage Potential Difference acc. to UL 508⁵ [V]	Primary connection [mm]	Secondary connection	Moulded	Dimensions approx. l x w x h [mm]	Mechanical outline
	14 / 20	600 ² / 1000 ² / 600 ³	opening 30 x 13	Molex 5045	no	56 x 46 (26) x 56	1
	14 / 20	600 ² / 1000 ² / 600 ³	opening 30 x 13	Molex 5045	yes	56 x 46 (26) x 56	1
	14 / 20	600 ² / 1000 ² / 600 ³	opening 30 x 13	Molex 5045	yes	56 x 46 (26) x 56	2
	14 / 20	600 ² / 1000 ² / 600 ³	opening 30 x 13	Molex 5045	yes	56 x 46 (26) x 56	1
	20 / 20	1000 ² / 1000 ² / 1000 ³	opening 40 x 20 (40)	Molex 7478	yes	90 (110) x 34 x 95	3
	20 / 20	1000 ² / 1000 ² / 1000 ³	opening 40 x 20 (40)	JST B3PS-VH	yes	90 (110) x 34 x 95	3
	20 / 20	1000 ² / 1000 ² / 1000 ³	opening 40 x 20 (40)	Molex Minifit jr	yes	90 (110) x 34 x 95	4
	20 / 20	1000 ² / 1000 ² / 1000 ³	opening 40 x 20 (40)	Molex 7478	yes	90 (110) x 34 x 95	3
	20 / 20	1000 ² / 1000 ² / 1000 ³	opening 40 x 20 (40)	JST B3PS-VH	yes	90 (110) x 34 x 95	3
	20 / 20	1000 ² / 1000 ² / 1000 ³	opening 40 x 20 (40)	Molex Minifit jr	yes	90 (110) x 34 x 95	4
	20 / 20	1000 ² / 1000 ² / 1000 ³	opening 40 x 20 (40)	JST BH03B-XASK-BN	yes	90 (110) x 34 x 95	5
	23 / 23	1000 ² / 1000 ² / 1000 ³	opening 40 x 20 (40)	JST B03B-XASK-1	yes	90 (110) x 34 x 95	6

For the most recent information and additional information, see our data sheets under
www.vacuumschmelze.com > Products > Cores & Inductive Components > Applications > Current Sensors/Transducers

Other types (for example, with other connectors) are available.

Thank you for your inquiry.

MECHANICAL OUTLINES

Drawing no. 1

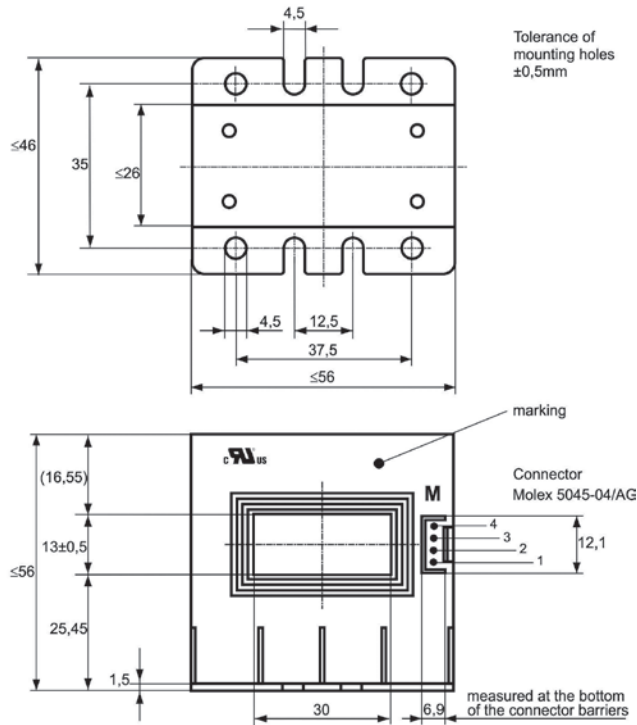

Type

T60404-N4648-X052

T60404-N4648-X053

T60404-N4644-X056

General tolerances DIN ISO 2768-c

Pin Assignment

- 1 $+V_c$
- 2 $-V_c$
- 3 I_s (output current)
- 4 Internal GND (can be omitted)

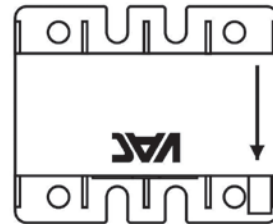

DC=Date Code
F=Factory

Drawing no. 2

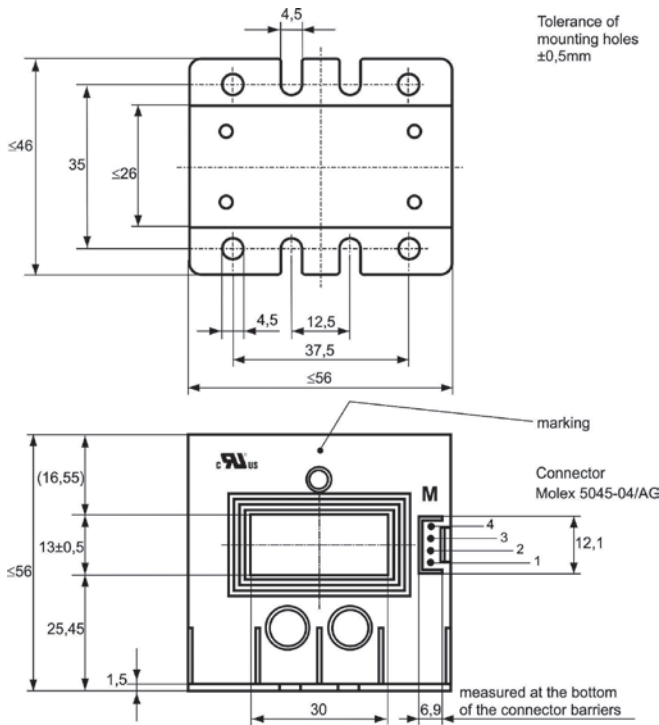

Type

T60404-N4648-X054

General tolerances DIN ISO 2768-c

Pin Assignment

- 1 $+V_c$
- 2 $-V_{cb}$
- 3 I_s (output current)
- 4 U_{ref} (never connect to GND)

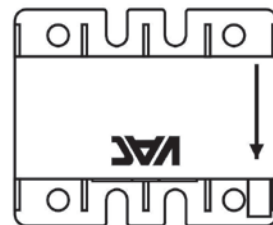

DC=Date Code
F=Factory

Drawing no. 3



Type

- T60404-P4640-X100
- T60404-P4640-X101
- T60404-P4640-X150
- T60404-P4640-X151

General tolerances DIN ISO 2768-c

Connector: Molex 7395 (3 Pin)

Pin Assignment

- 1 -U_c
- 2 -I_s
- 3 +U_c
- 4 I_s (output current)



Drawing no. 4

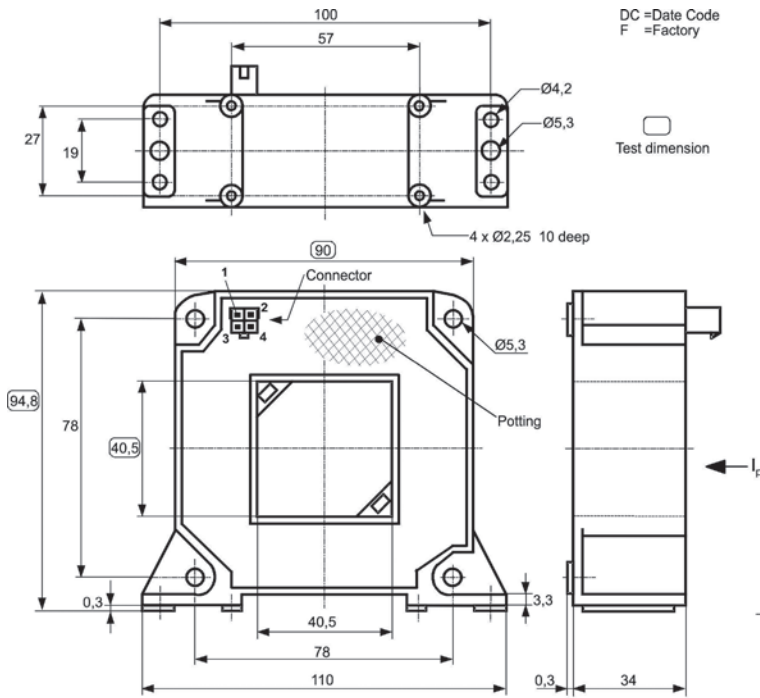

Type

- T60404-P4640-X102
- T60404-P4640-X152

General tolerances DIN ISO 2768-c

Connector: Molex Minifit

Pin Assignment

- 1 nc
- 2 +U_c
- 3 -U_c
- 4 I_s (output current)



Drawing no. 5



Type

T60404-P4640-X156

General tolerances DIN ISO 2768-c

Connector: JST BH03B-XASK-BN

Pin Assignment

- 1 $+U_c$
- 2 I_{out}
- 3 $-U_c$



Drawing no. 6



Type

T60404-P4640-X256

General tolerances DIN ISO 2768-c

Connector: JST B03B-XASK-1

Pin Assignment

Pin 1: $+U_c$

Pin 2: I_s

Pin 3: $-U_c$



RECOMMENDED CONNECTORS

Type	Connector on the VAC sensor	Counterpart connector housing	Counterpart connector contact
N4648-X052	Molex 5045 p/n 22-04-1041 (4 ctk.) or compatible	Molex 51191	Molex 50802
N4648-X053		Molex 5051	Molex 2759 or 5159
N4648-X054			
P4640-X100	Molex 7478, 6410, 7395 (3 ctk.) or compatible	Molex 2695 or 6471 (3 ctk.)	Molex 2759 or 4809
P4640-X150			
P4640-X101	JST B3PS-VH(LF)(SN) (3 ctk.) or compatible	JST VHR-3N	JST BVH-21T-P1.1
P4640-X151			
P4640-X154			
P4640-X156	JST BH03B-XASK-BN	XAP-03V-1	JST SXA-001T-P0.6
P4640-X102	Molex Minifit jr. 5569 (2 x 2 ctk.)	Molex Minifit jr. 5557	Molex 5556 or 45750
P4640-X152			
P4640-X159			
P4640-X256	JST B03B-XASK-1	JST XAP-03V-1	JST SXA-001T-P0.6

ALL-CURRENT SENSITIVE DIFFERENTIAL CURRENT SENSORS (AC/DC DI-SENSORS)



Control devices with all-current sensitive differential current sensors are used primarily in transformerless solar or traction inverters. Also in EV charging infrastructure and charging devices in general, DI sensors can be used.

An important safety function of these devices is the monitoring of leakage currents against earth of the entire system. These systems consist of either a photovoltaic module or motor in combination with the inverter, or the grid in combination with a battery. A defective system can become dangerous for humans or cause fire, therefore corresponding standards require that the inverter or charger disconnects from the grid, before it might become dangerous for the system or humans.

Leakage currents are unintended hence uncontrollable fault currents against earth and can contain direct as well as alternating portions, therefore AC/DC-sensitive monitoring is necessary. The key component is the VAC differential current sensor, whose measurement value is transmitted as an output voltage and evaluated by the control system.

Generally, protection devices with AC/DC-sensitive differential current sensors shall be used, where flat or pulsating direct currents can occur, whose amount is permanently greater than zero. Further examples are power supplies or uninterruptible power supplies.

TYPICAL PROPERTIES

- closed loop sensors with magnetic probe for highest accuracy and reliability
- differential current range of typically 30 mA up to 1000 mA
- full load current to 100 A
- single +5 V voltage supply
- voltage output for direct connection at A/D-converters
- automatic demagnetization of the sensor core for offset decrease
- self-monitoring and test functions
- measuring accuracy 1.5 %
- smallest temperature drift and highest long-term stability
- magnetic shielding against external fields
- frequency range DC to 10 kHz
- variants with pass-through opening or integrated primary conductors
- variants with or without test winding
- cost effective design

SENSOR VARIANTS

Available types are with pass trough opening as well as with integrated primary conductors for PCB mounting. Those sensors are designed with two or four conductors for single and three phase systems.

The additional functions demagnetization, error signaling and internal test are accessible through defined levels at the in/outputs V_{out} and V_{ref} .

TYPE SERIES OF VAC DIFFERENTIAL CURRENT

VAC Item no. Type T60404-N4646-	Mechanical outline no.	Primary conductor style	Number of primaries	Maximum primary current IPN [A]	Nominal differential current IΔN [mA]	Measuring range IΔP _{max.} [mA]	Supply voltage [V]	Supply current typ. [mA]	Output voltage [V]	Output voltage range [V]
	X911	1 pass through opening	–	85	300	850	5	15	$V_{ref} \pm (0.74 \times I_{\Delta P} / 300 \text{ mA})$	0.5 to 4.5
	X921	2 via PCB two conductors Ø 2.8 mm each	2	50	300			17	$V_{ref} \pm (0.74 \times I_{\Delta P} / 300 \text{ mA})$	
	X931	3 via PCB four conductors Ø 4.5 mm each	4	85	1000	1700	17	$V_{ref} \pm (1.2 \times I_{\Delta P} / 1000 \text{ mA})$		
	X932	4 via PCB four conductors Ø 2.8 mm each	4	50	300	850	17	$V_{ref} \pm (0.74 \times I_{\Delta P} / 300 \text{ mA})$		
	X956	5 pass through opening	–	50 ¹	300	850	5	17	$V_{ref} \pm (0.74 \times I_{\Delta P} / 300 \text{ mA})$	0.5 to 4.5
	X960	6 via PCB two conductors Ø 2.8 mm each	2	50						
	X975	7 via PCB two conductors Ø 2.8 mm each								

¹ Information about maximum primary current is only a guideline

² red-phosphorus-free

	Reference voltage	External test-current pin	Frequency range [Hz]	Measuring error (of nominal) at $T_{amb} = 25\text{ °C}$	Temperature drift -40 ... +85 °C [mV/°C]	Response time (up to 90 % of nominal diff. current) [μs]	Isolation strength acc. EN 50178		Qualified acc. to UL
							System voltage [V]	Working voltage [V]	
	2.5 V internal reference voltage or external reference	integrated in sensor	DC to 8 kHz	< 1.5 %	< 0.1	< 35	must be ensured by end user with suitable isolation of primary conductors		Yes, acc. UL 508
						< 50	600	1000	
	2.5 V internal reference voltage or external reference	integrated in sensor	DC to 10 kHz	< 1.5 %	< 0.1	< 35	must be ensured by end user with suitable isolation of primary conductors		Yes, acc. UL 508
		no					600	1000	
		integrated in sensor							

TYPE SERIES OF VAC DIFFERENTIAL CURRENT SENSORS

VAC Item no. Type T60404-N4646-		Mechanical outline no.	Primary conductor style	Number of primaries	Maximum primary current I _{PN} [A]	Nominal differential current I _{ΔN} [mA]	Measuring range I _{ΔP} _{max.} [mA]	Supply voltage [V]	Supply current typ. [mA]	Output voltage [V]	Output voltage range [V]
	P980 ²	8	pass through opening	–	120	1000	1700	5	15	$V_{ref} \pm (1.2 \times I_{\Delta P} / 1000 \text{ mA})$	0.5 to 4.5
	P981 ²	9	three conductors Ø 6 mm each	3							
	P982 ²	8	pass through opening	–	200	3000	5000	5	15	$V_{ref} \pm (1.2 \times I_{\Delta P} / 3000 \text{ mA})$	0.5 to 4.5
	P983 ²	9	three conductors Ø 6 mm each	3	150	1000	3000	5	15	$V_{ref} \pm (1.2 \times I_{\Delta P} / 1000 \text{ mA})$	0.5 to 4.5
	P985 ²	9	three conductors Ø 6 mm each	3	200	3000	5000	5	15	$V_{ref} \pm (1.2 \times I_{\Delta P} / 3000 \text{ mA})$	0.5 to 4.5

¹ Information about maximum primary current is only a guideline

² red-phosphorus-free

	Reference voltage	External test-current pin	Frequency range [Hz]	Measuring error (of nominal) at $T_{amb} = 25\text{ °C}$	Temperature drift -40 ... +85 °C [mV/°C]	Response time (up to 90 % of nominal diff. current) [μs]	Isolation strength acc. EN 50178		Qualified acc. to UL
							System voltage [V]	Working voltage [V]	
	2.5 V or external	integrated	10 kHz	< 1.5 %	0.08	40	600	1000	Yes, acc. UL 508
							600	1000	
	2.5 V or external	integrated	10 kHz	< 1.5 %	0.08	40	600	1000	Yes, acc. UL 508
	2.5 V or external	integrated	10 kHz	< 1.5 %	0.08	40	600	1000	Yes, acc. UL 508
	2.5 V or external	integrated	10 kHz	< 1.5 %	0.08	40	600	1000	Yes, acc. UL 508

MECHANICAL OUTLINES

Drawing no. 1

Type

T60404-N4646-X911



Marking	Connections	Pin assignments
Extract item no.	5 ... 10: 0.7 x 0.7 mm	9, 10: test current
F DC, in which		5: V_{out}
F = Factory		6: $V_{\text{in/out}}$
DC = Date Code		7: GND
		8: $V_c +5 \text{ V}$

Drawing no. 2

Type

T60404-N4646-X921



Marking	Connections	Pin assignments
UL Mark	1 ... 4: $\varnothing 2.8$ mm	1 ... 4: primary current
Extract item no.	5 ... 10: 0.7 x 0.7 mm	9, 10: test-current
F DC, in which		5: V_{out}
F = Factory		6: V_{ref}
DC = Date Code		7: GND
		8: $V_c +5$ V

Drawing no. 3

Type

T60404-N4646-X931

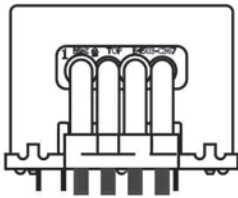

Prüfmaß
(test dimension)

Ohne Maßstab gezeichnet
(without scale drawn)

DC =Date Code
F=Factory

Marking	Connections	Pin assignments
UL Mark	1 ... 4: \varnothing 4.5 mm	1 ... 4; 11 ... 14: primary current
Extract item no.	11 ... 14: \varnothing 4.5 mm	9, 10: test-current
F DC, in which	5 ... 10: 0.7 x 0.7 mm	5: V_{out}
F = Factory		6: V_{ref}
DC = Date Code		7: GND
		8: $V_c +5 V$

Drawing no. 4

Type

T60404-N4646-X932



○ = Prüfmaß
(test dimension)

DC = Date Code
F = Factory

Marking	Connections	Pin assignments
UL Mark	1 ... 4: Ø 2.8 mm	1 ... 4; 13 ... 16: primary current
Extract item no.	13 ... 16: Ø 2.8 mm	9, 10: test-current
F DC, in which	5 ... 10: 0.7 x 0.7 mm	5: V_{out}
F = Factory		6: V_{ref}
DC = Date Code		7: GND
		8: $V_c +5 V$

Drawing no. 5

Type

T60404-N4646-X956



Marking	Connections	Pin assignments
UL Mark	1 ... 4: 0.7 x 0.6 mm	5, 6: test-current
Extract item no.	5 ... 6: \varnothing 0.8 mm	1: $V_c +5$ V
F DC, in which		2: GND
F = Factory		3: V_{ref} In/Out
DC = Date Code		4: V_{out}

Drawing no. 6

Type

T60404-N4646-X960

Toleranz der Stiftabstände $\pm 0,3\text{mm}$

DC = Date Code
F = Factory



Marking	Connections	Pin assignments
UL Mark	1 ... 4: Ø 2.8 mm	1 ... 4: primary current
Extract item no.	5 ... 8: 0.7 x 0.6 mm	5: V_{out}
F DC, in which		6: V_{ref}
F = Factory		7: GND
DC = Date Code		8: $V_c +5 V$

Drawing no. 7

Type
T60404-N4646-X975

Toleranz der Stiftabstände $\pm 0,3\text{mm}$

Prüfmaß

DC = Date Code
F = Factory

Beschriftung



Marking	Connections	Pin assignments
UL Mark	1 ... 4: \varnothing 2.8 mm	1 ... 4: primary current
Extract item no.	5 ... 8: 0.7 x 0.6 mm	9, 10: test-current
F DC, in which	9, 10: \varnothing 0.8 mm	5: V_{out}
F = Factory		6: V_{ref}
DC = Date Code		7: GND
		8: $V_c +5\text{ V}$

Drawing no. 8

Type

T60404-N4646-P980

T60604-N4646-P982



Marking	Connections	Pin assignments
UL Mark	1 ... 6: 0.7 x 0.6 mm	1: V_C
Extract item no.		2: GND
F DC, in which		3: V_{ref}
F = Factory		4: V_{out}
DC = Date Code		5, 6: $Test_{in}$

Drawing no. 9

Type

T60404-N4646-P981

T60404-N4646-P983

T60404-N4646-P985



Marking	Connections	Pin assignments
UL Mark	1 ... 6: 0.7 x 0.6 mm	1: V_C
Extract item no.	7 ... 12: $\varnothing 6$ mm	2: GND
F DC, in which		3: V_{ref}
F = Factory		4: V_{out}
DC = Date Code		5, 6: Test
		7-12: I_p

benvac ALL CURRENT SENSITIVE DIFFERENTIAL CURRENT SENSORS FOR IC-CPD (IN-CABLE CONTROL AND PROTECTION DEVICE) AND WALLBOX APPLICATIONS



To satisfy new standards including IEC 62752 (IC-CPD) and IEC 62955 (wallbox), charging of electrical vehicles requires differential current sensors to avoid hazardous situations in cases where the vehicle battery (DC) is connected to the home power supply (AC). Generally, AC/DC-sensitive differential current sensors can be used where direct current and alternating current circuits are connected and therefore AC/DC leakage currents can occur.

Typically, type A residual current circuit-breakers (RCCBs) are the sole type installed in private households, unable to identify and deactivate DC fault currents. Users seeking to charge an electric vehicle (EV) from a home power supply would therefore require a costly type B RCCB to guarantee safety in the presence of DC fault currents.

By using a VAC DI sensor integrated into an IC-CPD or wall box, customers can save themselves the high costs of installing a type B RCCB to provide all-current sensitivity and electrical safety at low cost.

A single DI sensor monitors simultaneously all currents in phases and neutral conductors sensing AC/DC fault currents. The sensor can activate automatic shut-off in case of hazardous electrical faults or signalize that the switch-off threshold was exceeded to a master device, which will then shut-off the system from the power supply. As the differential currents to be monitored only occur in the event of electrical faults and are extremely low (mA), maximum measurement precision is critical. In addition, a fast response time is required to maintain safety features and prevent humans from getting injured. Both requirements are excellently covered by the differential current sensor.

Based on the requirements of IEC 62955, the sensor portfolio (4641-X90x, -X92x) has been expanded to include variants for wallbox applications. The existing generation of sensors is continuously optimized in order to support our customers in a competitive environment. In addition, the portfolio was expanded to include the often requested vertical sensor with through-hole and a compact sensor with primary brackets.

TYPICAL PROPERTIES

- fault current detection according to IEC 62752, IEC 62955 or UL 2231
- frequency range DC up to 2 KHz
- load current up to $80 A_{rms}$ (1-phase) or $3 \times 32 A_{rms}$ (3-phase)
- switching outputs for threshold detection at 6 mA DC (IEC62955) and 30 mA AC (according to IEC 62752) as well as 5 mA AC and 20 mA AC (according to UL2231)
- serial interface (UART) on Generation 2 sensors (e.g. for querying measured values)
- integrated self-monitoring and test functions
- measurement resolution of 0.2 mA
- variants with pass through opening or with integrated primary conductors
- differential current range 0...300 mA
- robust mechanical design suitable for IC-CPD environmental requirements (e.g. drop test)
- widely usable in harsh electronic environment (e.g. resistant to external magnetic fields)
- total system cost significantly reduced compared to RCD type B

The design of the **benvac** sensors is based on the following patents from Bender GmbH & Co. KG, Grünberg: EP2571128 / US9397494 / CN103001175 // EP2813856

TYPE SERIES OF VAC DIFFERENTIAL CURRENT SENSORS

VAC Item no. Type T60404-N4641-		Mechanical outline no.	Primary conductor style	Number of primaries	Maximum primary current* [A]	Nominal differential current [mA]	Measuring range ΔP_{max} . [mA]	Supply voltage [V]	Supply current typ. [mA]	Output voltage [V]
	X900	1	pass through opening	-	80/40	I Δ N1 6 mA DC I Δ N2 30 mA AC	300	5	50	Open Collector max. 40 V
	X901					I Δ N1 5 mA AC I Δ N2 20 mA AC				
	X903					I Δ N1 6 mA DC I Δ N2 20 mA AC				
	X904					I Δ N1 6 mA DC				
	X905					I Δ N1 6 mA DC I Δ N2 30 mA AC				
	X920	2	primary conductor	4	40	I Δ N1 6 mA DC I Δ N2 30 mA AC	300	5	50	Open Collector max. 40 V
	X921					I Δ N1 5 mA AC I Δ N2 20 mA AC				
	X922					I Δ N1 6 mA DC				
	X925									
 	X936	3	pass through opening	-	80/40	I Δ N1 6 mA DC I Δ N2 20 mA AC	300	5	50	Open Collector max. 40 V
	X943	4	primary conductor	2	20					

* Richtwert 1-phasig / 3-phasig

	LReference voltage	Frequency range [Hz]	Qualified acc. to	Application
	Test function	DC bis 2 kHz	IEC 62752	IC-CPD
			UL 2231	IC-CPD & Wallbox
			IEC 62752 UL 2231	IC-CPD
			IEC 62955	Wallbox
			IEC 62752	IC-CPD
			IEC 62752	
			UL 2231	IC-CPD & Wallbox
			IEC 62955	Wallbox
			IEC 62955 UL 2231	
			IEC 62752 UL 2231	
Test function / Test winding at Pin 8				

MECHANICAL OUTLINES

Drawing no. 1

Type

T60404-N4641-X900
 T60404-N4641-X901
 T60404-N4641-X903
 T60404-N4641-X904
 T60404-N4641-X905

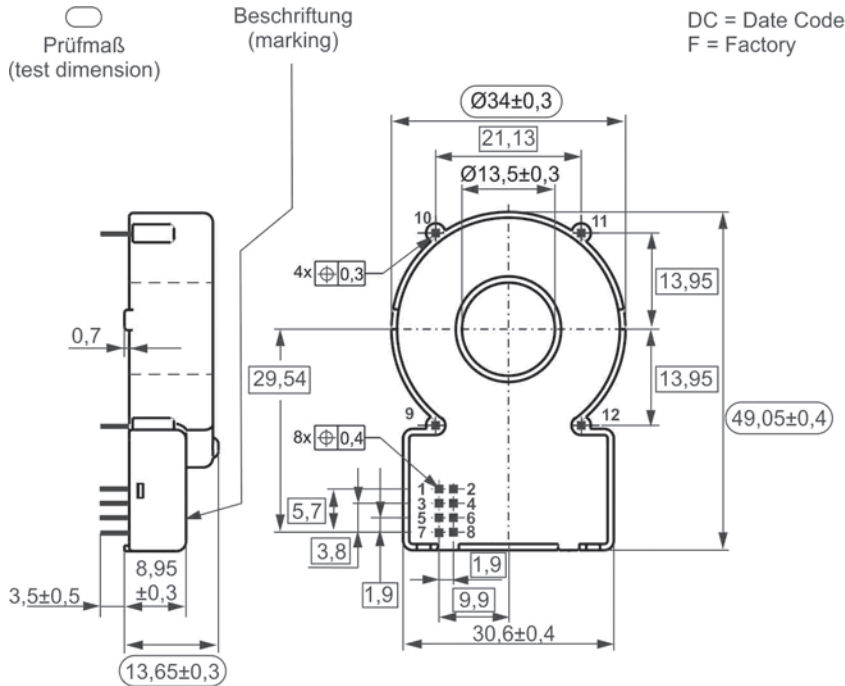

Marking	Connections	Pin assignments
UL Mark	1 ... 8: 0,46 x 0,46 mm	1: Error _{out}
Extract item no.	9 ... 12: 0,7 x 0,7 mm	2: Test _{in}
F DC, in which F = Factory DC = Date Code		3: X6 _{out}
		4: X30 _{out}
		5: GND
		6: V _c +5 V
		7: PWM _{out}
		8: N.C.

MECHANICAL OUTLINES

Drawing no. 2

Type

T60404-N4641-X920

T60404-N4641-X921

T60404-N4641-X922

T60404-N4641-X925



Marking	Connections	Pin assignments
UL Mark	1 ... 8: 0,46 x 0,46 mm	1: Error _{out}
Extract item no.	9 ... 12: Ø 2.5 mm	2: Test _{in}
F DC, in which F = Factory DC = Date Code		3: X6 _{out}
		4: X30 _{out}
		5: GND
		6: V _c +5 V
		7: PWM _{OUT}
		8: N.C.

MECHANICAL OUTLINES

Drawing no. 3

Typ

T60404-N4641-X936

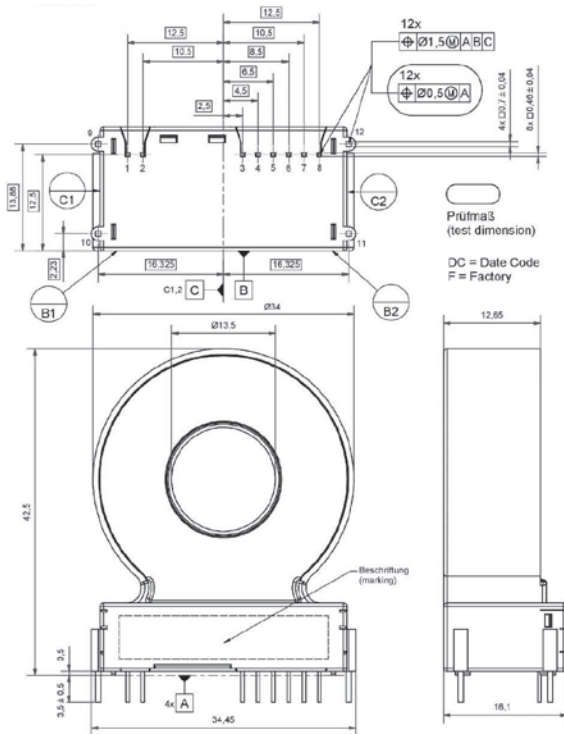

Marking	Connections	Pin assignments
UL Mark	1 ... 8: 0.46 x 0.46 mm	1: VCC
Extract item no.	9 ... 12: 0.7 x 0.7 mm	2: GND
F DC, in which F = Factory DC = Date Code		3: TxD
		4: RxD-T
		5: DE
		6: X20-OUT
		7: X6-OUT
		8: T-W

KEY TO PART NUMBERS

T60404-...	
M4645	Passive sensors that require external electronics
N4641	Fluxgate sensors (DI sensors for EV charging)
N4644	Sensors with fully discrete electronics (older models)
N4646	Sensors for +5V or +/- 15V operation with voltage or current output using IC controller
N4647	EMC-optimized sensors for +5V power supply and voltage output
N4648	Sensors for +/- 15V or +/- 24V power supply and current output with new integrated ASIC
P4640	High current sensors > 1000A _{rms} with ASIC
N464x-P	red-phosphorus-free

CROSS-REFERENCE

VAC current sensors are often used as a replacement for LEM current sensors. For a faster selection, we have included a reference list here. A large part of the components requires no redesign of your circuit.

PCB MOUNT WITH INTEGRAL PRIMARY CONDUCTOR

VAC part number	LEM part number
T60404-N4646-	
X651	CAS 25-NP or LTS 25-NP ¹
X652	CAS 15-NP or LTS 15-NP ¹
X653	CAS 6-NP or LTS 6-NP ¹
X654	CAS 50-NP ¹
X661	CASR 25-NP or LTSR 25-NP ¹
X662	CASR 15-NP or LTSR 15-NP ¹
X663	CASR 6-NP or LTSR 6-NP ⁴
X664	CASR 50-NP ¹
X761	CKSR 25-NP ¹
X762	CKSR 15-NP ¹
X763	CKSR 6-NP ¹
X764	CKSR 50-NP ¹
X111	LA 55-TP ²
X112	LA 55-TP/SP1/SP2 ²
X410	LAH 50-P/SP1 ²
X412	LAH 50-P 100-P ²
X413	none ³
X460	LAS 50-TP ²
X461	LAS 100-TP ²
T60404-4648-	
X300	LA 25-NP ²
X400	LAH 25-NP

PCB MOUNT WITH APERTURE

VAC part number	LEM part number
T60404-N4646-	
X950	CTSR 0.3-P or 0.6-P ⁴
X100	LA 55-P/SP2 ²
X101	LA 100-P 55-P/SP1 ²
X160	none ⁵
X161	none ⁵
X200	LA 125-P ²
X201	LA 200-P ²

- 1 VAC has the same footprint and pinout but is taller by 8 mm
- 2 Drop-in replacement
- 3 1500:1 ratio
- 4 Not form factor compatible
- 5 5V version of X100, 1000:1
- 6 +/-15V connector pinout differences
- 7 +/-15V, JST BVH-21T-P1.1
- 8 +/-15V, connector pinout differences
- 9 +/-24V, connector pinout differences
- 10 +/-24V, JST BVH-21T-P1.1

**PANEL MOUNT
WITH APERTURE**

VAC part number	LEM part number
T60404-P4640-	
X100	LF 1005-S or LF 1010-S ⁶
X101	LF 1005-S/SP variant ⁷
X102	LF 1005-S/SP22 ⁸
X150	LF 1005-S or LF 1010-S ⁹
X151	LF 1005-S/SP variant ¹⁰
X152	LF 1005-S/SP22 ⁹

VAC part number	LEM part number
T60404-N4644-	
X052	LAC 300-S/SP1/SP5 ²
X053	LAC 300-S/SP1/SP5 ²
X054	none
X056	LAC 300-S/SP2 ²
X060	LAC 300-S/SP3/SP4 ²

