



Tango 11A

ISM & Dual-Band Wi-Fi/5G,4G Through Hole Puck Antenna



Key Features

- Supports 5G NR / 4G LTE / 3G UMTS / 2G GSM
- Supports LTE Cat M, LTE Cat NB, NR Cat NB bands
- Supports Wi-Fi 2.4 GHz and 5 GHz spectrum
- Supports LoRa, Sigfox, ISM 868 MHz, ISM 915 MHz, IEEE 802.15.4
- Supports Bluetooth, Zigbee, WLAN2400, WLAN5800, ISM 2.4 GHz, ISM 5.8 GHz

Additional Considerations

- IP67 weatherproof rating makes it suitable for internal or external use
- Low profile design for covert and anti-theft applications

General Description

The Tango 11A puck antenna operates on 850/1800/1900/2100MHz bands supporting quad band GSM/GPRS networks throughout Europe, Asia and Africa with the addition of 3G UMTS, 4G/5G LTE and Dual Band Wi-Fi.

The tough case and through hole mount design makes it suitable for use in external environments like high sided vehicles. The RF cable is fed via the through hole mount base to ensure no cable is visible when fixed and the rubber 'skirt' around the base protects against water ingress.

The antenna is finished with an SMA Male connector and comes in different cable lengths. Alternative connector types and cable lengths can be specified for small volume orders.

| | | | | |
|-------------------|-------------------|--------------------|--------------------|------------------|
| O Wall/Pole | 2G GSM | 3G UMTS | 4G LTE | 5G New Radio |
| LTE Cat M | LTE NB IoT | NR NB IoT | ISM 868 | ISM 2.4G |
| ISM 5.8G | IEEE 802.15.4 | LoRa Wireless | SF Sigfox | BLE Bluetooth |
| WiFi 2.4G & 5G | WiFi 4 802.11n | WiFi 5 802.11ac | WiFi 6 802.11ax | ZB Zigbee |
| Z Wave | WLAN 2400 | WLAN 5800 | HNT Helium | W Weightless |
| IP 67 | | | | |



Tango 11A

ISM & Dual-Band Wi-Fi/5G,4G Through Hole Puck Antenna

Electrical Specifications

| | |
|---------------------------|----------|
| Impedance: | 50 Ohm |
| Polarization: | Vertical |
| Max Input Power: | 50 W |
| Ground plane independent: | Yes |

Environmental Specifications

| | |
|------------------------------|---------------|
| Operating Temperature range: | -40 to +85 °C |
| Storage Temperature range: | -40 to +85 °C |

Mechanical Specifications

| | |
|------------------------|-------------------------------|
| Dimensions: | 23 mm height x 80 mm diameter |
| Weight: | 85 g |
| Connector: | SMA Male |
| Cable: | RG174 |
| Mounting method: | M17 Screw Mount |
| Mounting Screw Length: | 22 mm |
| Max Panel Thickness: | 13 mm |
| Radome materials: | Nylon PA6 |

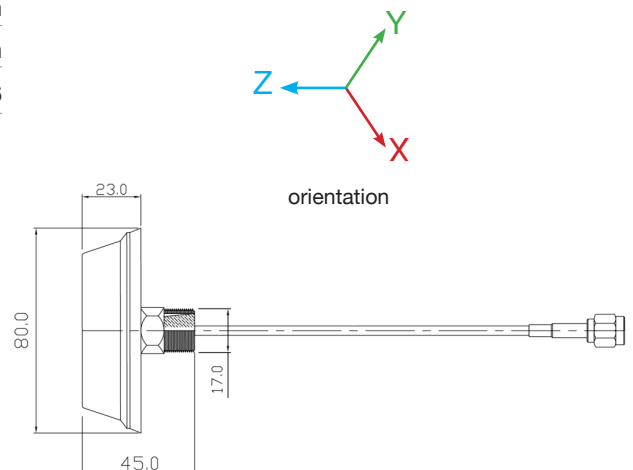



Tango 11A

ISM & Dual-Band Wi-Fi/5G,4G Through Hole Puck Antenna

Spectrum Coverage

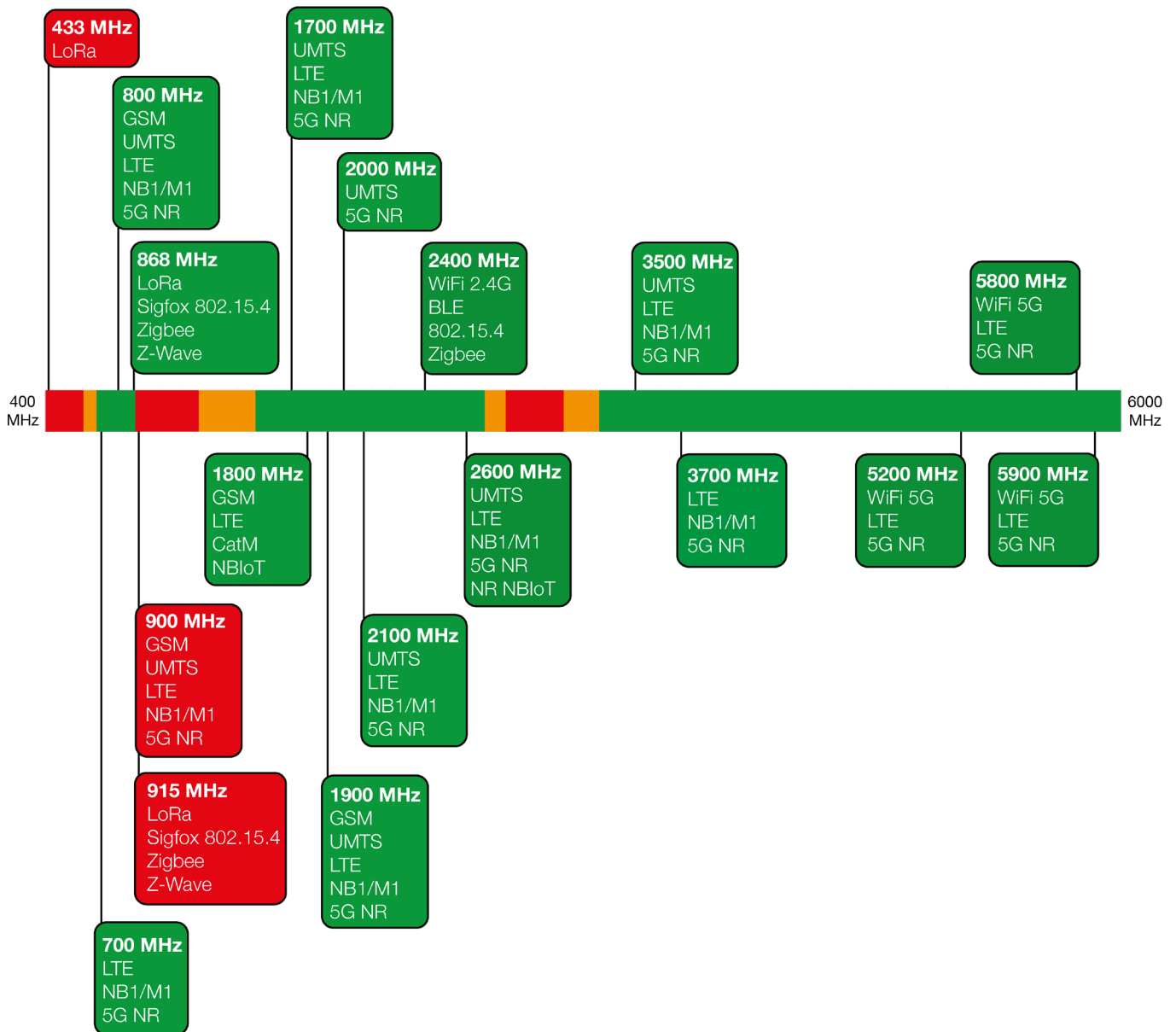

● Suitable band ● Adequate band in good signal conditions ● Likely to be unsuitable



Tango 11A

ISM & Dual-Band Wi-Fi/5G,4G Through Hole Puck Antenna

Usable Cellular Frequency Support (410 MHz – 1900 MHz)

| | 410 | 450 | 600 | 700 | 800 | 850 | 900 | 1500 | 1600 | 1700 | 1800 | 1900 |
|-------------------|-----|-----|-----|-----|-----|-----|-----|------|------|------|------|------|
| GSM Bands: | | | | | | ● | | | | | ● | ● |
| UMTS Bands: | | | | ● | ● | ● | | ● | | ● | ● | ● |
| LTE Bands: | | | ● | ● | ● | ● | | ● | ● | ● | ● | ● |
| LTE Cat M Bands: | | | ● | ● | ● | ● | | ● | ● | ● | ● | ● |
| LTE Cat NB Bands: | | | ● | ● | ● | ● | | ● | ● | ● | ● | ● |
| 5G NR Bands: | | | ● | ● | ● | ● | | ● | ● | ● | ● | ● |
| NR Cat NB Bands: | | | | ● | ● | ● | | | | ● | ● | ● |

Usable Cellular Frequency Support (2000 MHz – 5900 MHz)

| | 2000 | 2100 | 2300 | 2400 | 2500 | 2600 | 3300 | 3500 | 3700 | 4700 | 5200 | 5900 |
|-------------------|------|------|------|------|------|------|------|------|------|------|------|------|
| GSM Bands: | | | | | | | | | | | | |
| UMTS Bands: | | ● | | | | ● | | ● | | | | |
| LTE Bands: | ● | ● | ● | ● | ● | ● | ● | ● | ● | | ● | ● |
| LTE Cat M Bands: | | ● | ● | | ● | ● | | ● | ● | | | |
| LTE Cat NB Bands: | | ● | | | ● | ● | | ● | ● | | | |
| 5G NR Bands: | ● | ● | ● | ● | ● | ● | | ● | ● | ● | ● | ● |
| NR Cat NB Bands: | | ● | | | ● | ● | | | | | | |

Usable ISM Frequency Support (433 MHz - 5800 MHz)

| | 433 | 868 | 915 | 2450 | 5800 |
|---------------|-----|-----|-----|------|------|
| Bluetooth | | | | ● | |
| IEEE 802.15.4 | | ● | | ● | |
| LoRa | | ● | | | |
| Sigfox | | ● | | | |
| WiFi 2.4G | | | | ● | |
| WiFi 5G | | | | | ● |
| Zigbee | | ● | | ● | |
| Z-Wave | | ● | | | |



Tango 11A

ISM & Dual-Band Wi-Fi/5G,4G Through Hole Puck Antenna

Peak Gain vs. Frequency

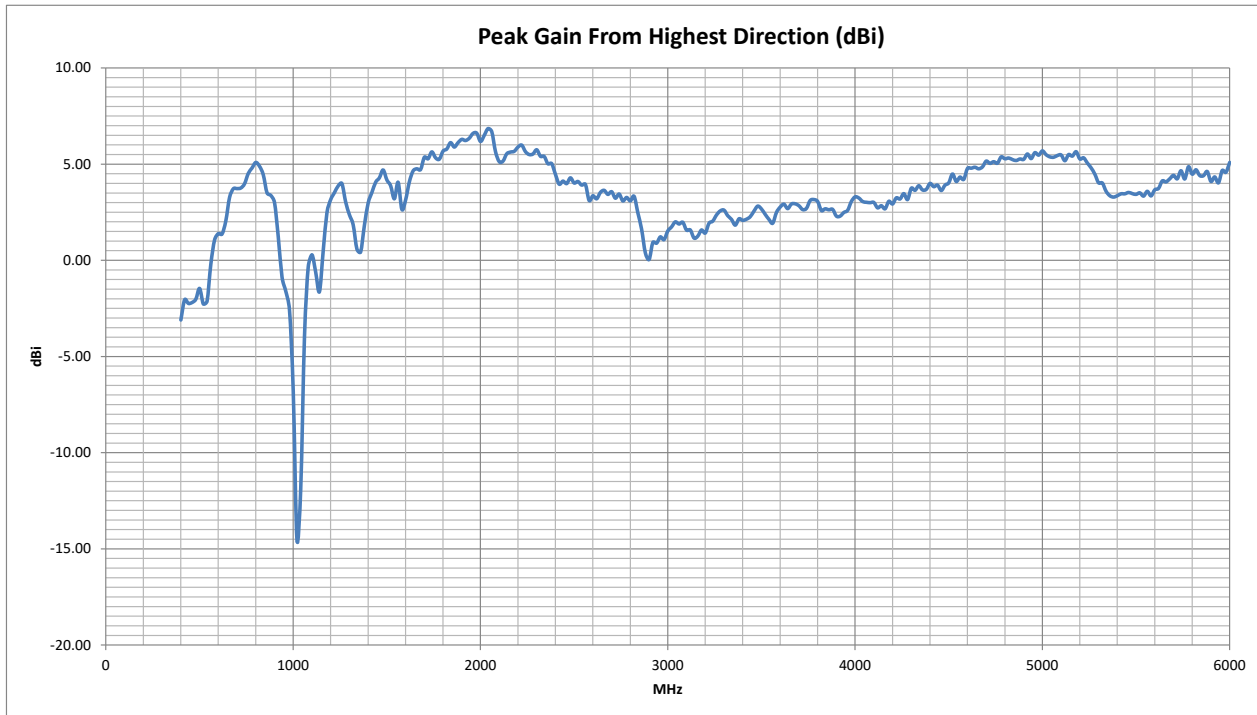

Return Loss

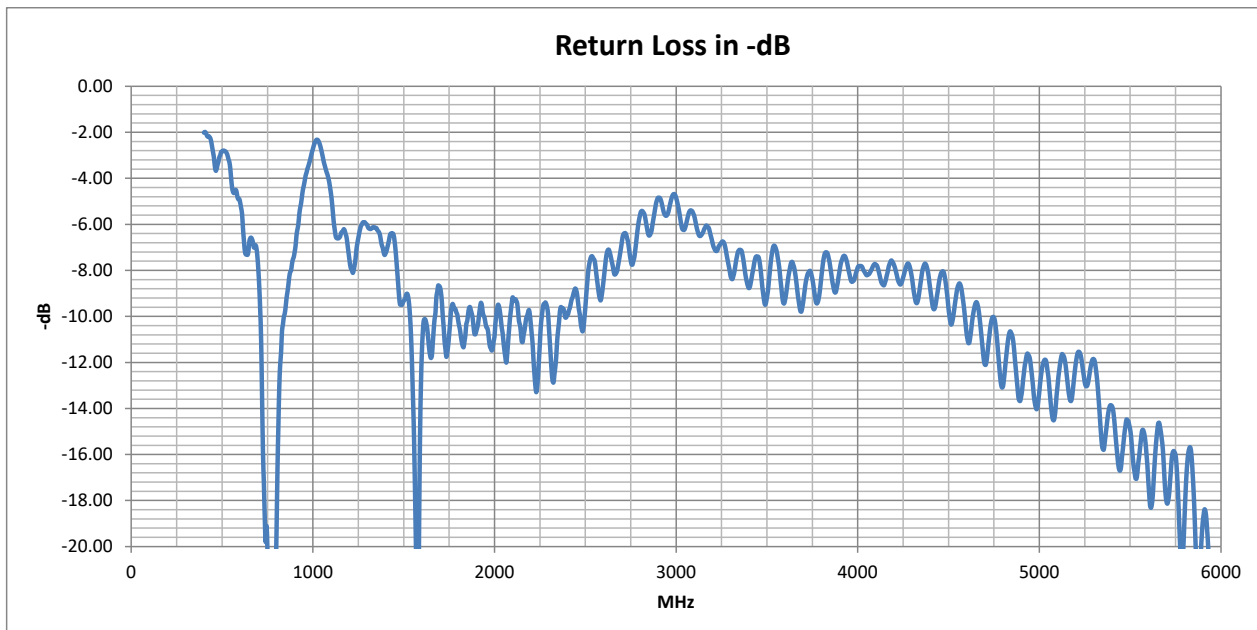



Tango 11A

ISM & Dual-Band Wi-Fi/5G,4G Through Hole Puck Antenna

VSWR

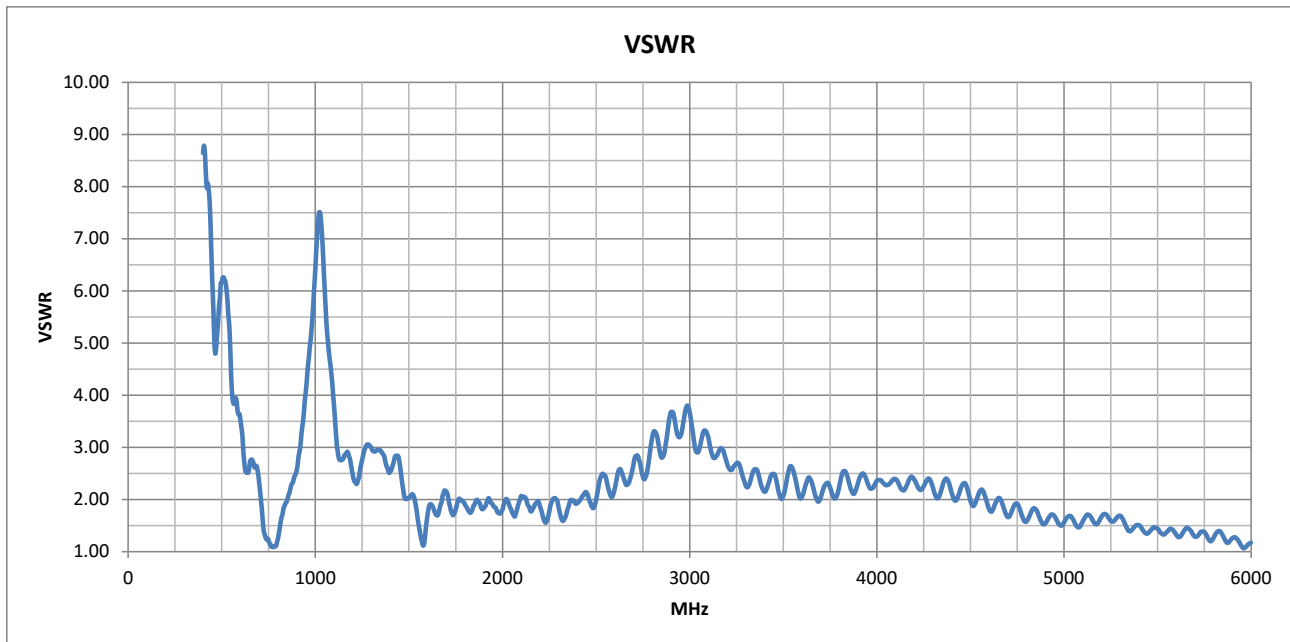

Radiation Efficiency

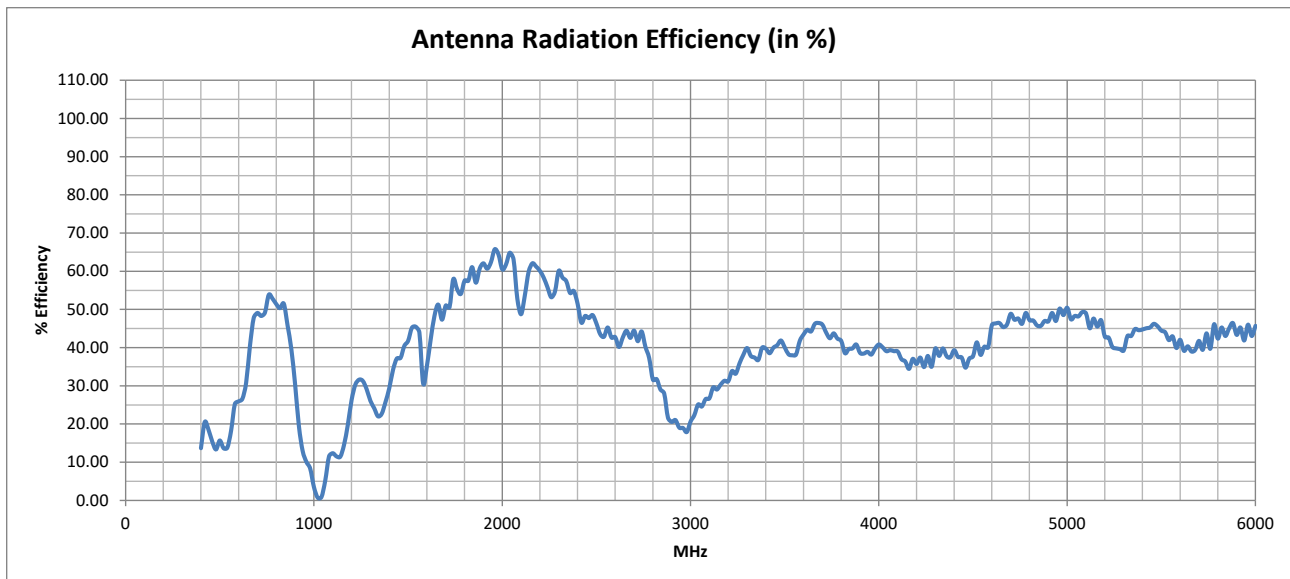



Tango 11A

ISM & Dual-Band Wi-Fi/5G,4G Through Hole Puck Antenna

Cellular Standards Band Support

| GSM (2G) Band | UMTS (3G) Band | E-UTRA (4G) Band | Cat M E-UTRA Band | Cat NB E-UTRA Band | NR (5G) Band | Cat NB NR (5G) Band | Uplink | Downlink | Average Upload Efficiency (%) | Average Download Efficiency (%) | Maximum Upload VSWR | Maximum Download VSWR | Use Indicator |
|---------------|----------------|------------------|-------------------|--------------------|--------------|---------------------|---------------------|---------------------|-------------------------------|---------------------------------|---------------------|-----------------------|---------------|
| | 1 | 1 | 1 | 1 | n1 | n1 | 1920 - 1980 MHz | 2110 - 2170 MHz | 63.56 | 58.30 | 2.02 | 2.05 | ● |
| PCS-1900 | 2 | 2 | 2 | 2 | n2 | n2 | 1850 - 1910 MHz | 1930 - 1990 MHz | 60.04 | 63.95 | 1.99 | 2.01 | ● |
| DCS-1800 | 3 | 3 | 3 | 3 | n3 | n3 | 1710 - 1785 MHz | 1805 - 1880 MHz | 54.55 | 58.77 | 2.04 | 1.99 | ● |
| | 4 | 4 | 4 | 4 | | | 1710 - 1755 MHz | 2110 - 2155 MHz | 54.37 | 57.12 | 2.04 | 2.05 | ● |
| GSM-850 | 5 | 5 | 5 | 5 | n5 | n5 | 824 - 849 MHz | 869 - 894 MHz | 50.76 | 38.57 | 1.98 | 2.48 | ● |
| | 6 | | | | | | 830 - 840 MHz | 875 - 885 MHz | 51.23 | 39.44 | 1.92 | 2.40 | ● |
| | 7 | 7 | 7 | 7 | n7 | n7 | 2500 - 2570 MHz | 2620 - 2690 MHz | 44.16 | 42.86 | 2.49 | 2.58 | ● |
| E-GSM-900 | 8 | 8 | 8 | 8 | n8 | n8 | 880 - 915 MHz | 925 - 960 MHz | 31.30 | 13.21 | 2.91 | 4.54 | ● |
| | 9 | 9 | | | | | 1749.9 - 1784.9 MHz | 1844.9 - 1879.9 MHz | 55.05 | 58.72 | 2.01 | 1.99 | ● |
| | 10 | 10 | | | | | 1710 - 1770 MHz | 2110 - 2170 MHz | 54.58 | 58.30 | 2.04 | 2.05 | ● |
| | 11 | 11 | 11 | 11 | | | 1427.9 - 1447.9 MHz | 1475.9 - 1495.9 MHz | 36.62 | 40.81 | 2.84 | 2.06 | ● |
| | 12 | 12 | 12 | 12 | n12 | n12 | 699 - 716 MHz | 729 - 746 MHz | 48.79 | 49.29 | 2.35 | 1.33 | ● |
| | 13 | 13 | 13 | 13 | n13 | n13 | 777 - 787 MHz | 746 - 756 MHz | 52.69 | 51.75 | 1.10 | 1.24 | ● |
| | 14 | 14 | 14 | 14 | n14 | | 788 - 798 MHz | 758 - 768 MHz | 51.91 | 53.62 | 1.22 | 1.15 | ● |
| | | 17 | | 17 | | | 704 - 716 MHz | 734 - 746 MHz | 48.70 | 49.49 | 2.18 | 1.27 | ● |
| | | 18 | 18 | 18 | n18 | n18 | 815 - 830 MHz | 860 - 875 MHz | 50.59 | 43.49 | 1.83 | 2.30 | ● |
| | 19 | 19 | 19 | 19 | | | 830 - 845 MHz | 875 - 890 MHz | 51.09 | 38.35 | 1.94 | 2.45 | ● |
| | 20 | 20 | 20 | 20 | n20 | n20 | 832 - 862 MHz | 791 - 821 MHz | 49.15 | 51.12 | 2.14 | 1.67 | ● |
| | 21 | 21 | 21 | 21 | | | 1447.9 - 1462.9 MHz | 1495.9 - 1510.9 MHz | 37.33 | 42.42 | 2.75 | 2.07 | ● |
| | 22 | 22 | | | | | 3410 - 3490 MHz | 3510 - 3590 MHz | 40.25 | 39.18 | 2.49 | 2.64 | ● |
| | | 24 | 24 | 24 | n24 | | 1626.5 - 1660.5 MHz | 1525 - 1559 MHz | 48.40 | 45.04 | 1.87 | 2.07 | ● |
| | 25 | 25 | 25 | 25 | n25 | n25 | 1850 - 1915 MHz | 1930 - 1995 MHz | 60.13 | 63.80 | 1.99 | 2.01 | ● |
| | 26 | 26 | 26 | 26 | n26 | | 814 - 849 MHz | 859 - 894 MHz | 50.68 | 40.28 | 1.98 | 2.48 | ● |
| | | 27 | 27 | | | | 807 - 824 MHz | 852 - 869 MHz | 50.64 | 45.61 | 1.71 | 2.24 | ● |
| | | 28 | 28 | 28 | n28 | n28 | 703 - 748 MHz | 758 - 803 MHz | 48.96 | 52.67 | 2.22 | 1.30 | ● |

● Suitable band

● Adequate band in good signal conditions

● Likely to be unsuitable



Tango 11A

ISM & Dual-Band Wi-Fi/5G,4G Through Hole Puck Antenna

Cellular Standards Band Support

| GSM (2G) Band | UMTS (3G) Band | E-UTRA (4G) Band | Cat M E-UTRA Band | Cat NB E-UTRA Band | NR (5G) Band | Cat NB NR (5G) Band | Uplink | Downlink | Average Upload Efficiency (%) | Average Download Efficiency (%) | Maximum Upload VSWR | Maximum Download VSWR | Use Indicator |
|---------------|----------------|------------------|-------------------|--------------------|--------------|---------------------|-------------------|-------------------|-------------------------------|---------------------------------|---------------------|-----------------------|---------------|
| | | 28A | | | | | 703 - 733 MHz | 758 - 788 MHz | 48.62 | 53.14 | 2.22 | 1.15 | ● |
| | | 29 | | | n29 | | N/A | 717 - 728 MHz | N/A | 48.45 | N/A | 1.69 | ● |
| | | 30 | | | n30 | | 2305 - 2315 MHz | 2350 - 2360 MHz | 59.23 | 55.10 | 1.77 | 1.95 | ● |
| | | 31 | 31 | 31 | | | 452.5 - 457.5 MHz | 462.5 - 467.5 MHz | 16.20 | 14.90 | 5.90 | 4.94 | ● |
| | 32 | 32 | | | | | N/A | 1452 - 1496 MHz | N/A | 39.36 | N/A | 2.65 | ● |
| | | 33 | | | | | 1900 - 1920 MHz | 1900 - 1920 MHz | 61.38 | 61.38 | 1.98 | 1.98 | ● |
| | | 34 | | | n34 | | 2010 - 2025 MHz | 2010 - 2025 MHz | 61.72 | 61.72 | 2.01 | 2.01 | ● |
| | | 35 | | | | | 1850 - 1910 MHz | 1850 - 1910 MHz | 60.04 | 60.04 | 1.99 | 1.99 | ● |
| | | 36 | | | | | 1930 - 1990 MHz | 1930 - 1990 MHz | 63.95 | 63.95 | 2.01 | 2.01 | ● |
| | | 37 | | | | | 1910 - 1930 MHz | 1910 - 1930 MHz | 61.06 | 61.06 | 2.02 | 2.02 | ● |
| | | 38 | | | n38 | | 2570 - 2620 MHz | 2570 - 2620 MHz | 42.33 | 42.33 | 2.54 | 2.54 | ● |
| | | 39 | 39 | | n39 | | 1880 - 1920 MHz | 1880 - 1920 MHz | 61.38 | 61.38 | 1.98 | 1.98 | ● |
| | | 40 | 40 | | n40 | | 2300 - 2400 MHz | 2300 - 2400 MHz | 56.15 | 56.15 | 1.99 | 1.99 | ● |
| | | 41 | 41 | 41 | n41 | n41 | 2496 - 2690 MHz | 2496 - 2690 MHz | 43.27 | 43.27 | 2.58 | 2.58 | ● |
| | | 42 | 42 | 42 | | | 3400 - 3600 MHz | 3400 - 3600 MHz | 39.90 | 39.90 | 2.64 | 2.64 | ● |
| | | 43 | 43 | 43 | | | 3600 - 3800 MHz | 3600 - 3800 MHz | 44.28 | 44.28 | 2.42 | 2.42 | ● |
| | | 44 | | | | | 703 - 803 MHz | 703 - 803 MHz | 50.95 | 50.95 | 2.22 | 2.22 | ● |
| | | 45 | | | | | 1447 - 1467 MHz | 1447 - 1467 MHz | 37.48 | 37.48 | 2.77 | 2.77 | ● |
| | | 46 | | | n46 | | 5150 - 5925 MHz | 5150 - 5925 MHz | 42.93 | 42.93 | 1.72 | 1.72 | ● |
| | | 47 | | | n47 | | 5855 - 5925 MHz | 5855 - 5925 MHz | 44.97 | 44.97 | 1.27 | 1.27 | ● |
| | | 48 | | | n48 | | 3550 - 3700 MHz | 3550 - 3700 MHz | 43.74 | 43.74 | 2.59 | 2.59 | ● |
| | | 49 | | | | | 3550 - 3700 MHz | 3550 - 3700 MHz | 43.74 | 43.74 | 2.59 | 2.59 | ● |
| | | 50 | | | n50 | | 1432 - 1517 MHz | 1432 - 1517 MHz | 39.68 | 39.68 | 2.84 | 2.84 | ● |
| | | 51 | | | n51 | | 1427 - 1432 MHz | 1427 - 1432 MHz | 35.60 | 35.60 | 2.84 | 2.84 | ● |
| | | 52 | | | | | 3300 - 3400 MHz | 3300 - 3400 MHz | 38.38 | 38.38 | 2.58 | 2.58 | ● |

● Suitable band

● Adequate band in good signal conditions

● Likely to be unsuitable



Tango 11A

ISM & Dual-Band Wi-Fi/5G,4G Through Hole Puck Antenna

Cellular Standards Band Support

| GSM (2G) Band | UMTS (3G) Band | E-UTRA (4G) Band | Cat M E-UTRA Band | Cat NB E-UTRA Band | NR (5G) Band | Cat NB NR (5G) Band | Uplink | Downlink | Average Upload Efficiency (%) | Average Download Efficiency (%) | Maximum Upload VSWR | Maximum Download VSWR | Use Indicator |
|---------------|----------------|------------------|-------------------|--------------------|--------------|---------------------|-------------------|-------------------|-------------------------------|---------------------------------|---------------------|-----------------------|---------------|
| | | 53 | | | n53 | | 2483.5 - 2495 MHz | 2483.5 - 2495 MHz | 47.52 | 47.52 | 1.91 | 1.91 | ● |
| | | 65 | | 65 | n65 | n65 | 1920 - 2010 MHz | 2110 - 2200 MHz | 63.02 | 59.18 | 2.02 | 2.05 | ● |
| | | 66 | 66 | 66 | n66 | n66 | 1710 - 1780 MHz | 2110 - 2200 MHz | 54.56 | 59.18 | 2.04 | 2.05 | ● |
| | | 67 | | | n67 | | N/A | 738 - 758 MHz | N/A | 51.07 | N/A | 1.25 | ● |
| | | 68 | | | | | 698 - 728 MHz | 753 - 783 MHz | 48.66 | 53.20 | 2.38 | 1.18 | ● |
| | | 69 | | | | | N/A | 2570 - 2620 MHz | N/A | 42.33 | N/A | 2.54 | ● |
| | | 70 | | 70 | n70 | n70 | 1695 - 1710 MHz | 1995 - 2020 MHz | 50.81 | 61.14 | 2.17 | 2.01 | ● |
| | | 71 | 71 | 71 | n71 | | 663 - 698 MHz | 617 - 652 MHz | 46.53 | 30.24 | 2.75 | 2.85 | ● |
| | | 72 | 72 | 72 | | | 451 - 456 MHz | 461 - 466 MHz | 16.43 | 15.05 | 6.04 | 5.02 | ● |
| | | 73 | 73 | 73 | | | 450 - 455 MHz | 460 - 465 MHz | 16.59 | 15.16 | 6.13 | 5.08 | ● |
| | | 74 | 74 | 74 | n74 | | 1427 - 1470 MHz | 1475 - 1518 MHz | 37.12 | 41.92 | 2.84 | 2.09 | ● |
| | | 75 | | | n75 | | N/A | 1432 - 1517 MHz | N/A | 39.68 | N/A | 2.84 | ● |
| | | 76 | | | n76 | | N/A | 1427 - 1432 MHz | N/A | 35.60 | N/A | 2.84 | ● |
| | | | | | n77 | | 3300 - 4200 MHz | 3300 - 4200 MHz | 40.17 | 40.17 | 2.64 | 2.64 | ● |
| | | | | | n78 | | 3300 - 3800 MHz | 3300 - 3800 MHz | 41.35 | 41.35 | 2.64 | 2.64 | ● |
| | | | | | n79 | | 4400 - 5000 MHz | 4400 - 5000 MHz | 44.44 | 44.44 | 2.31 | 2.31 | ● |
| | | | | | n80 | | 1710 - 1785 MHz | N/A | 54.55 | N/A | 2.04 | N/A | ● |
| | | | | | n81 | | 880 - 915 MHz | N/A | 31.30 | N/A | 2.91 | N/A | ● |
| | | | | | n82 | | 832 - 862 MHz | N/A | 49.15 | N/A | 2.14 | N/A | ● |
| | | | | | n83 | | 703 - 748 MHz | N/A | 48.96 | N/A | 2.22 | N/A | ● |
| | | | | | n84 | | 1920 - 1980 MHz | N/A | 63.56 | N/A | 2.02 | N/A | ● |
| | | 85 | 85 | 85 | n85 | | 698 - 716 MHz | 728 - 746 MHz | 48.80 | 49.26 | 2.38 | 1.35 | ● |
| | | | | | n86 | | 1710 - 1780 MHz | N/A | 54.56 | N/A | 2.04 | N/A | ● |
| | | 87 | 87 | 87 | | | 410 - 415 MHz | 420 - 425 MHz | 17.95 | 20.26 | 8.65 | 8.06 | ● |
| | | 88 | 88 | 88 | | | 412 - 417 MHz | 422 - 427 MHz | 18.63 | 20.07 | 8.49 | 8.06 | ● |

● Suitable band

● Adequate band in good signal conditions

● Likely to be unsuitable



Tango 11A

ISM & Dual-Band Wi-Fi/5G,4G Through Hole Puck Antenna

Cellular Standards Band Support

| GSM (2G) Band | UMTS (3G) Band | E-UTRA (4G) Band | Cat M E-UTRA Band | Cat NB E-UTRA Band | NR (5G) Band | Cat NB NR (5G) Band | Uplink | Downlink | Average Upload Efficiency (%) | Average Download Efficiency (%) | Maximum Upload VSWR | Maximum Download VSWR | Use Indicator |
|---------------|----------------|------------------|-------------------|--------------------|--------------|---------------------|---------------------|-----------------|-------------------------------|---------------------------------|---------------------|-----------------------|---------------|
| | | | | | n89 | | 824 - 849 MHz | N/A | 50.76 | N/A | 1.98 | N/A | ● |
| | | | | | n90 | n90 | 2496 - 2690 MHz | 2496 - 2690 MHz | 43.27 | 43.27 | 2.58 | 2.58 | ● |
| | | | | | n91 | | 832 - 862 MHz | 1427 - 1432 MHz | 49.15 | 35.60 | 2.14 | 2.84 | ● |
| | | | | | n92 | | 832 - 862 MHz | 1432 - 1517 MHz | 49.15 | 39.68 | 2.14 | 2.84 | ● |
| | | | | | n93 | | 880 - 915 MHz | 1427 - 1432 MHz | 31.30 | 35.60 | 2.91 | 2.84 | ● |
| | | | | | n94 | | 880 - 915 MHz | 1432 - 1517 MHz | 31.30 | 39.68 | 2.91 | 2.84 | ● |
| | | | | | n95 | | 2010 - 2025 MHz | N/A | 61.72 | N/A | 2.01 | N/A | ● |
| | | | | | n97 | | 2300 - 2400 MHz | N/A | 56.15 | N/A | 1.99 | N/A | ● |
| | | | | | n98 | | 1880 - 1920 MHz | N/A | 61.38 | N/A | 1.98 | N/A | ● |
| | | | | | n99 | | 1626.5 - 1660.5 MHz | N/A | 48.40 | N/A | 1.87 | N/A | ● |
| | | | | | n101 | | 1900 - 1910 MHz | 1900 - 1910 MHz | 61.73 | 61.73 | 1.88 | 1.88 | ● |
| | | | | 103 | | | 787 - 788 MHz | 757 - 758 MHz | 52.30 | 53.25 | 1.10 | 1.15 | ● |

● Suitable band

● Adequate band in good signal conditions

● Likely to be unsuitable

NOTE: For each frequency band, Siretta provides a traffic light indication to show the suitability of the antenna for use at that frequency band. Determination of exactly what makes an antenna good or bad at any frequency is subjective.

The view presented is that of Siretta's engineering team having taken into account the efficiency and VSWR measurements. The end user is advised to use their own criteria and/or testing to confirm suitability.



Tango 11A

ISM & Dual-Band Wi-Fi/5G,4G Through Hole Puck Antenna

ISM Standards Frequency Support

| Application | Frequency Range | Efficiency (%) | Maximum VSWR | Peak Gain from highest direction (dBi) | Use Indicator |
|-------------------------|---------------------|----------------|--------------|--|---------------|
| ISM 433 MHz | 433.05 - 434.79 MHz | 19.14 | 7.81 | -2.1735 | ● |
| IMT 868 MHz | 863 - 870 MHz | 43.80 | 2.25 | 3.4905 | ● |
| ISM 915 MHz | 902 - 928 MHz | 22.53 | 3.32 | 2.832 | ● |
| ISM 2.4 GHz | 2400 - 2500 MHz | 48.02 | 2.14 | 4.47 | ● |
| Wi-Fi 2.4G | 2401 - 2483 MHz | 48.13 | 2.14 | 4.4445 | ● |
| Wi-Fi 2.4G (USA) | 2401 - 2473 MHz | 48.10 | 2.14 | 4.4445 | ● |
| Wi-Fi 2.4G (Japan) | 2401 - 2495 MHz | 48.06 | 2.14 | 4.4445 | ● |
| Wi-Fi 5G (all channels) | 5150 - 5990 MHz | 43.01 | 1.72 | 5.65 | ● |
| Wi-Fi 5G (Ch 32-48) | 5150 - 5250 MHz | 43.72 | 1.72 | 5.65 | ● |
| Wi-Fi 5G (Ch 32-64) | 5150 - 5330 MHz | 42.27 | 1.72 | 5.65 | ● |
| Wi-Fi 5G (Ch 32-161) | 5150 - 5815 MHz | 42.64 | 1.72 | 5.65 | ● |
| Wi-Fi 5G (Ch 32-173) | 5150 - 5875 MHz | 42.80 | 1.72 | 5.65 | ● |
| ISM 5.8 GHz | 5725 - 5875 MHz | 43.57 | 1.39 | 4.87 | ● |

● Suitable band

● Adequate band in good signal conditions

● Likely to be unsuitable

NOTE: For each frequency band, Siretta provides a traffic light indication to show the suitability of the antenna for use at that frequency band. Determination of exactly what makes an antenna good or bad at any frequency is subjective.

The view presented is that of Siretta's engineering team having taken into account the efficiency and VSWR measurements. The end user is advised to use their own criteria and/or testing to confirm suitability.



Tango 11A

ISM & Dual-Band Wi-Fi/5G,4G Through Hole Puck Antenna

2D Radiation Plots

600 MHz XY

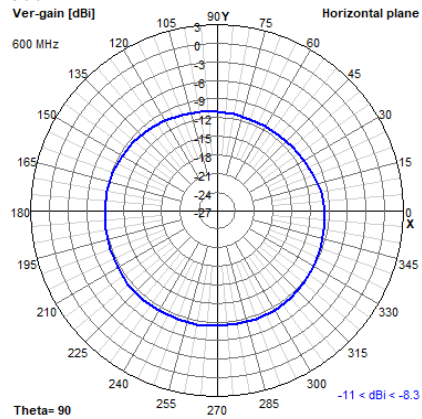

XZ

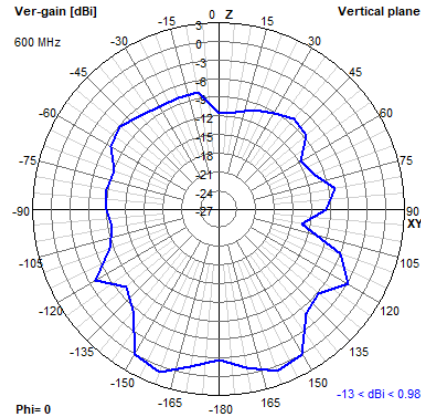

YZ

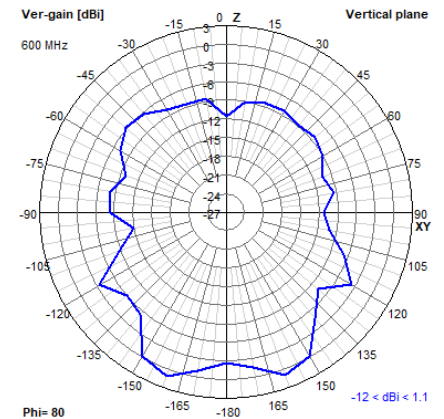

700 MHz XY

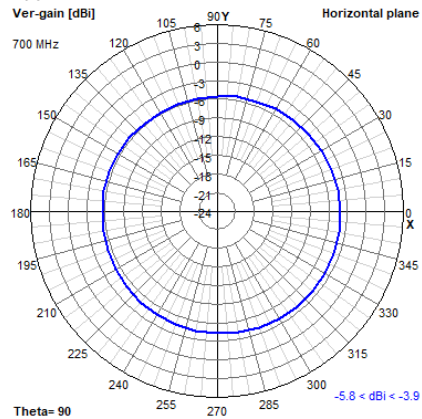

XZ

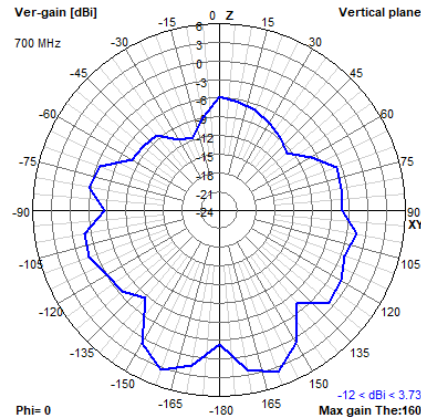

YZ

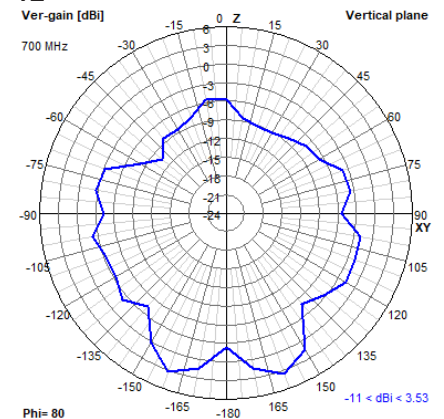

800 MHz XY

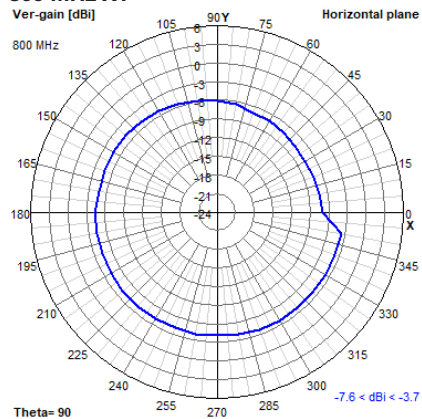

XZ

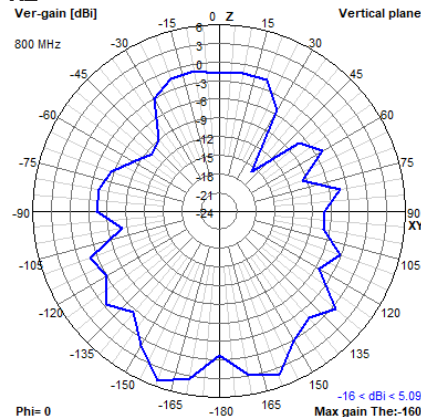

YZ

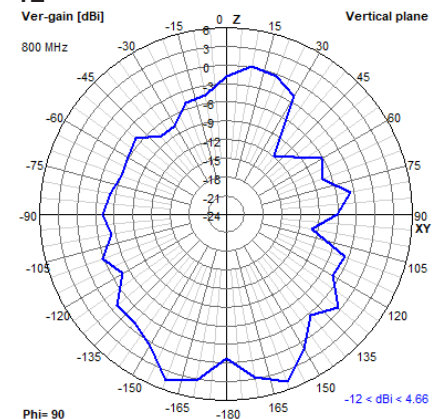



Tango 11A

ISM & Dual-Band Wi-Fi/5G,4G Through Hole Puck Antenna

2D Radiation Plots

1500 MHz XY

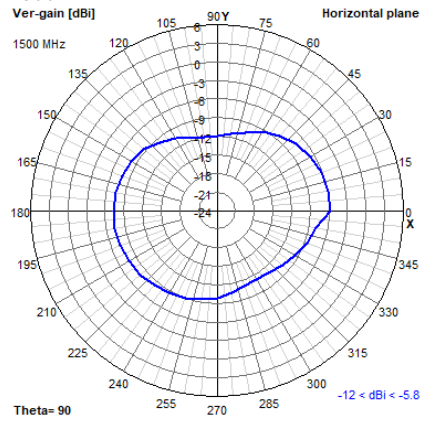

XZ

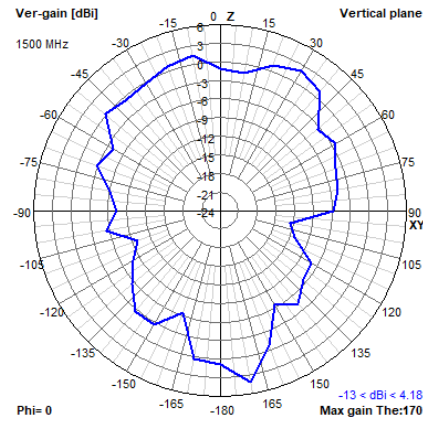

YZ

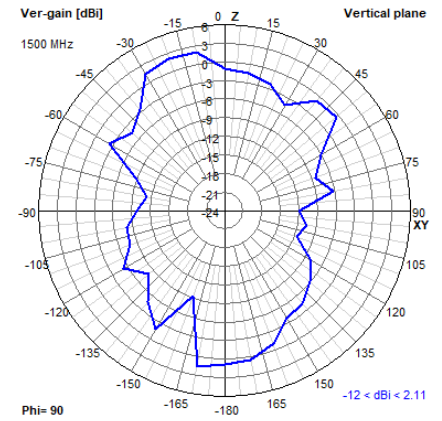

1600 MHz XY

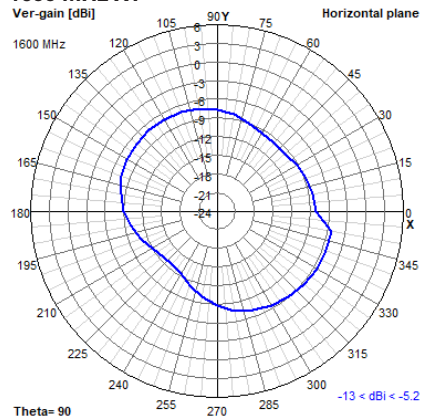

XZ

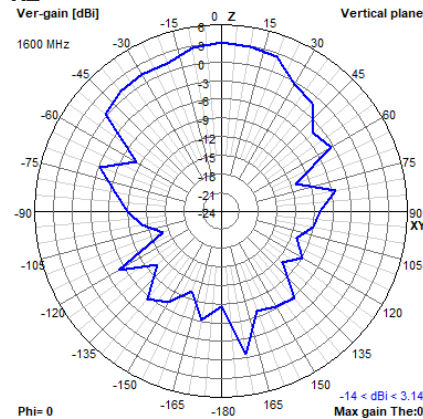

YZ

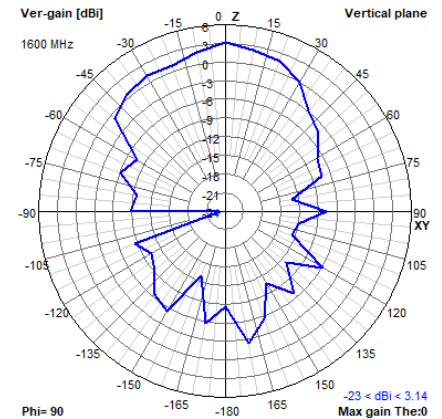

1700 MHz XY

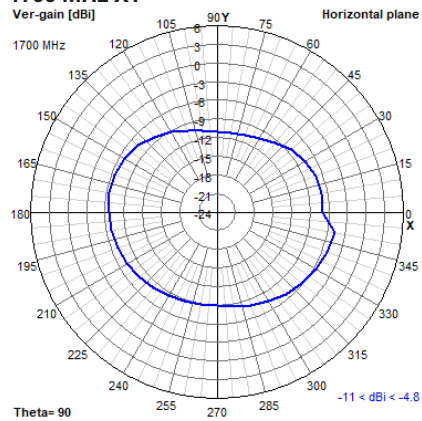

XZ

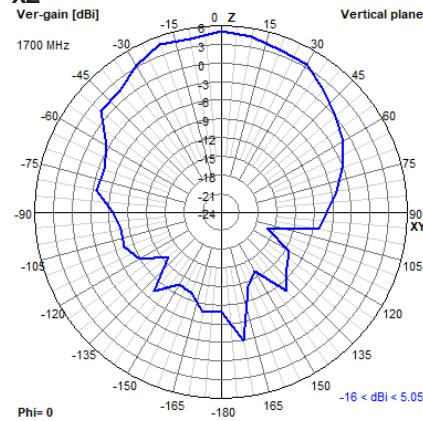

YZ

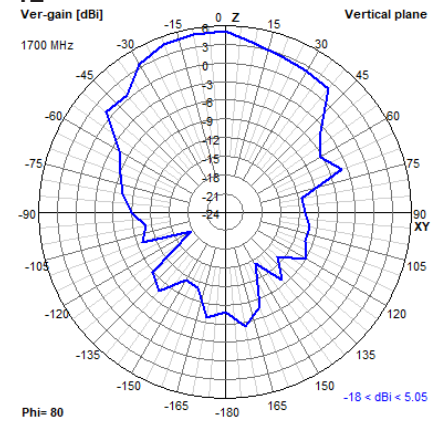



Tango 11A

ISM & Dual-Band Wi-Fi/5G,4G Through Hole Puck Antenna

2D Radiation Plots

1800 MHz XY

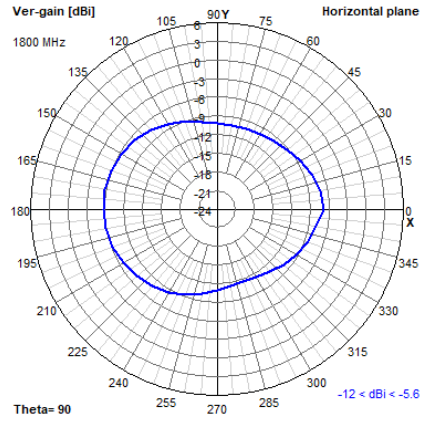

XZ

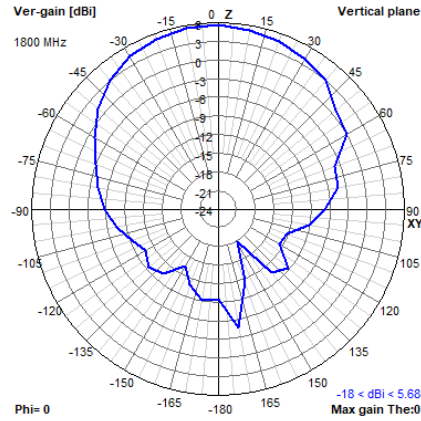

YZ

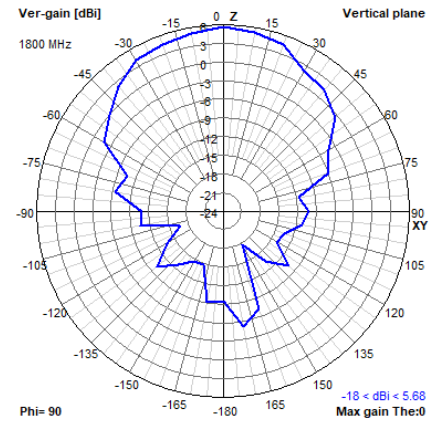

1900 MHz XY

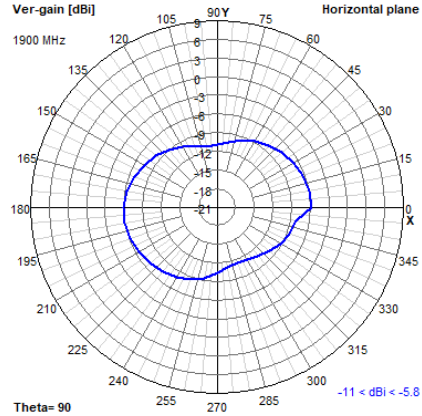

XZ

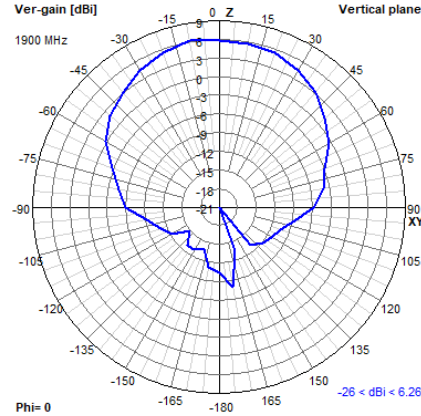

YZ

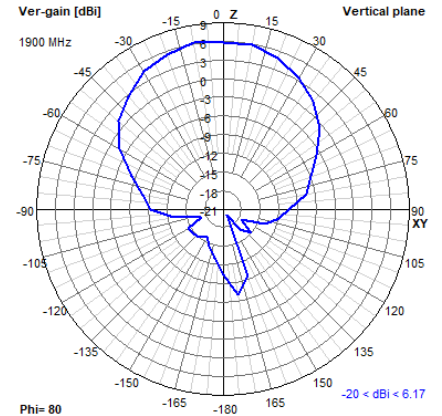

2000 MHz XY

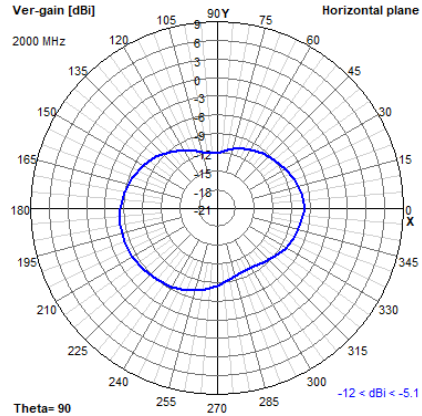

XZ

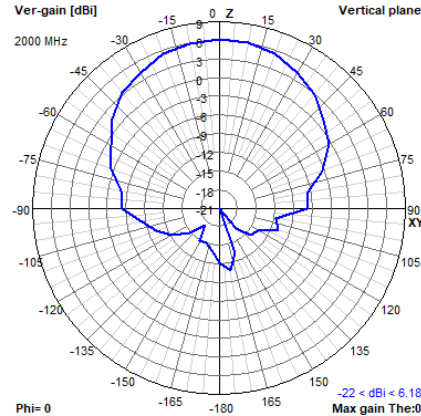

YZ

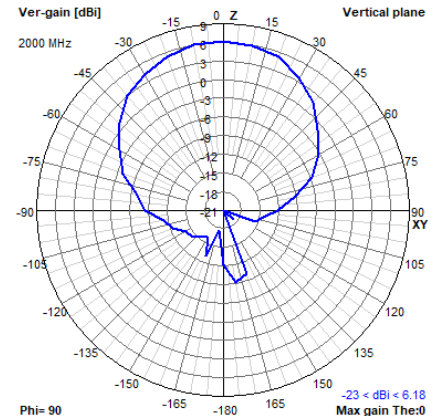



Tango 11A

ISM & Dual-Band Wi-Fi/5G,4G Through Hole Puck Antenna

2D Radiation Plots

2100 MHz XY

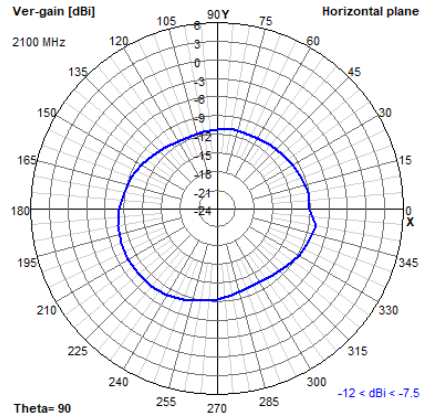

XZ

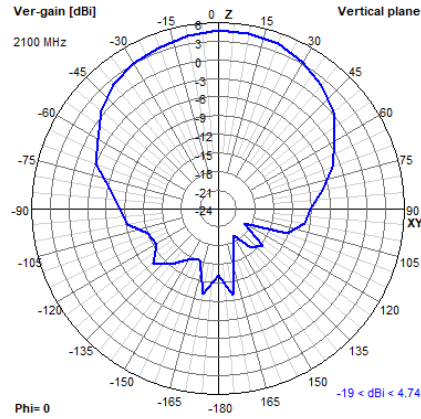

YZ

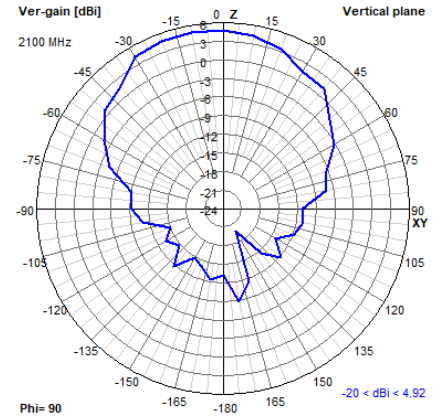

2300 MHz XY

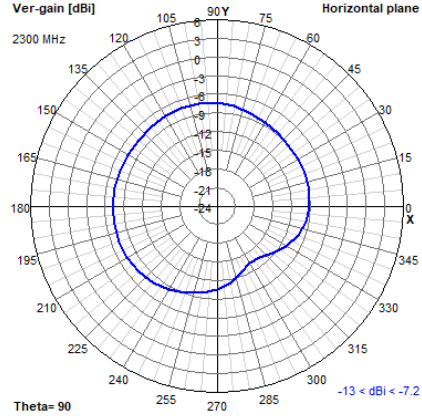

XZ

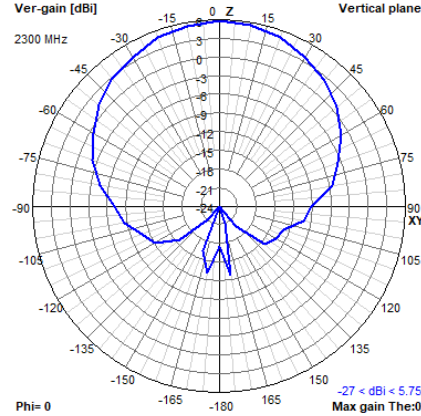

YZ

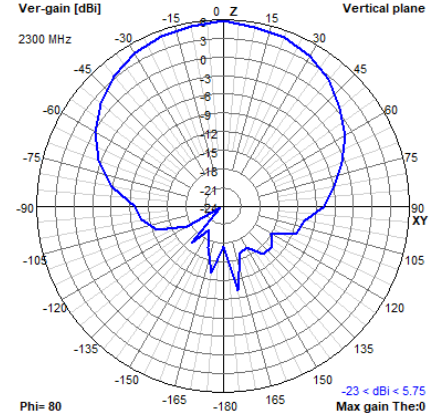

2400 MHz XY

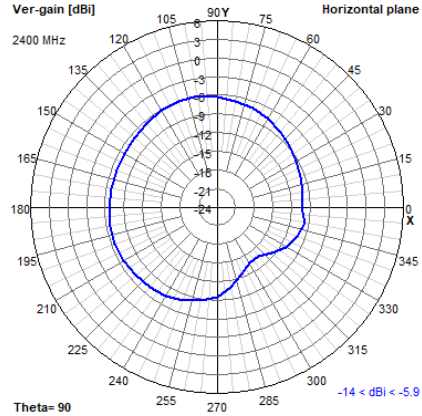

XZ

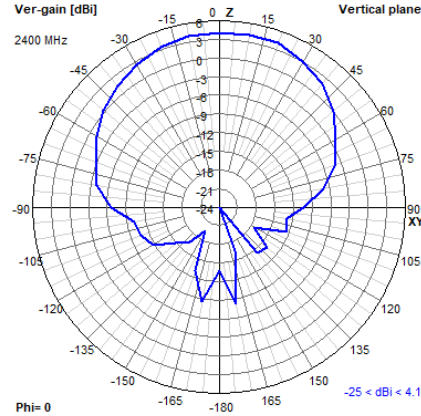

YZ

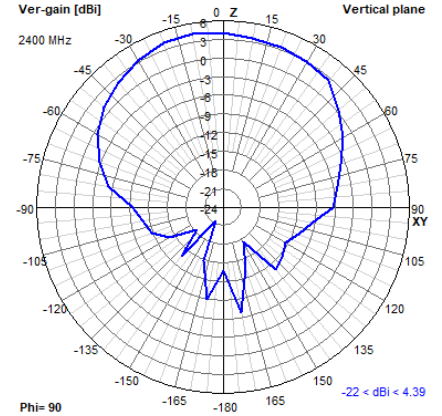



Tango 11A

ISM & Dual-Band Wi-Fi/5G,4G Through Hole Puck Antenna

2D Radiation Plots

2500 MHz XY

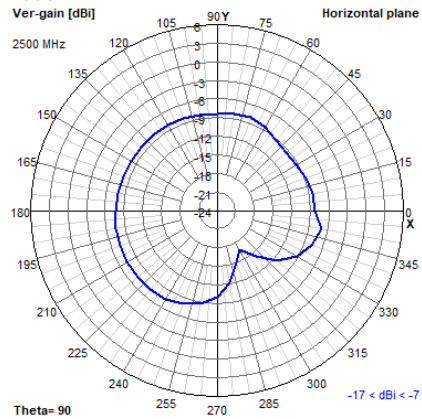

XZ

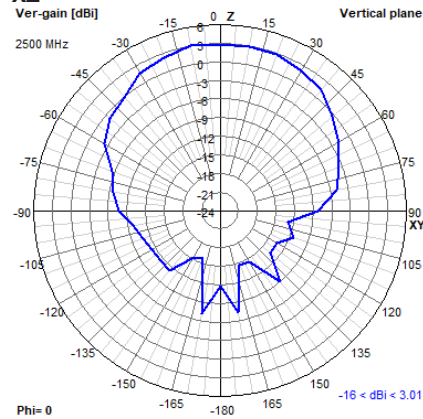

YZ

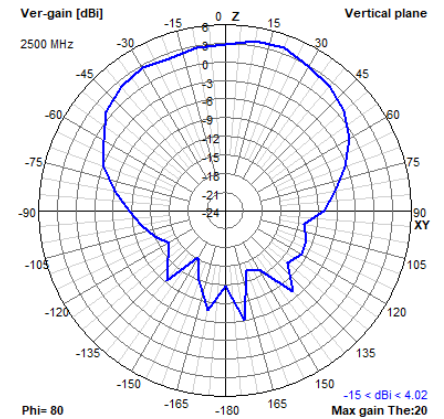

2600 MHz XY

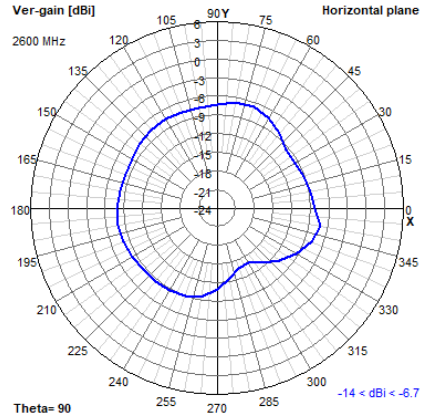

XZ

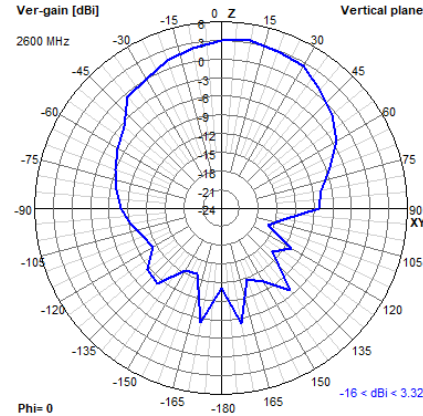

YZ

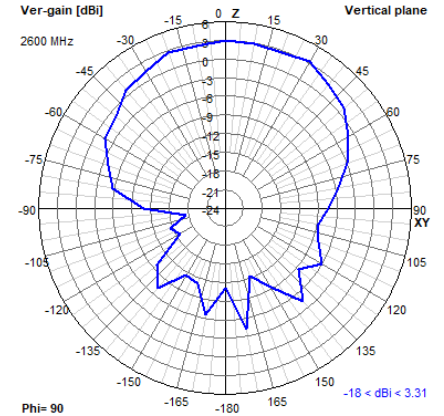

3300 MHz XY

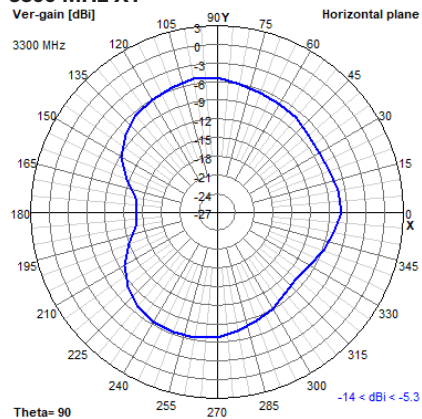

XZ

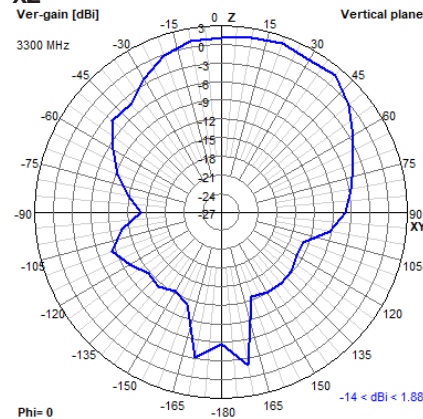

YZ

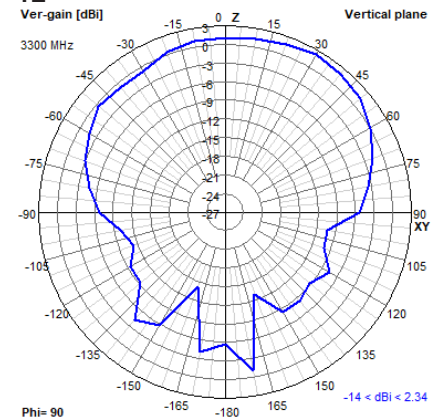



Tango 11A

ISM & Dual-Band Wi-Fi/5G,4G Through Hole Puck Antenna

2D Radiation Plots

3500 MHz XY

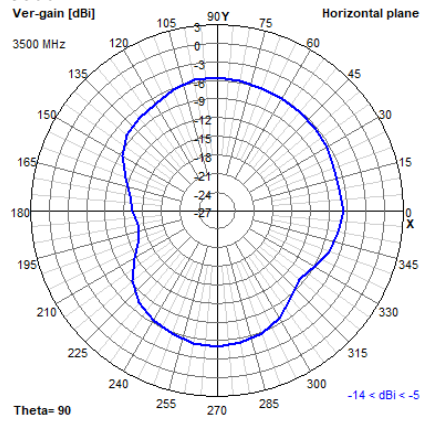

XZ

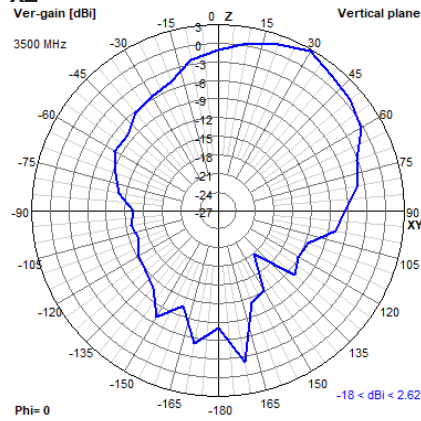

YZ

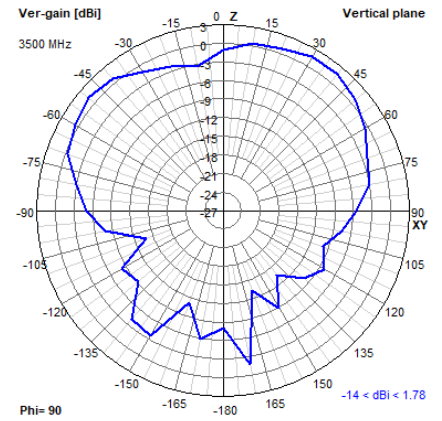

3700 MHz XY

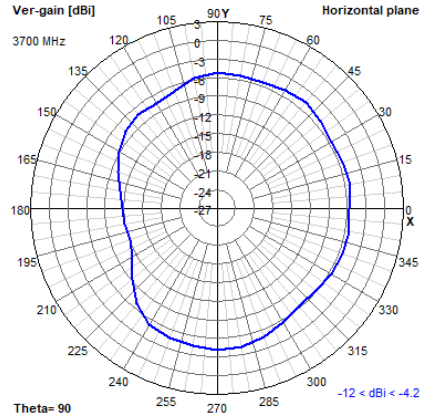

XZ

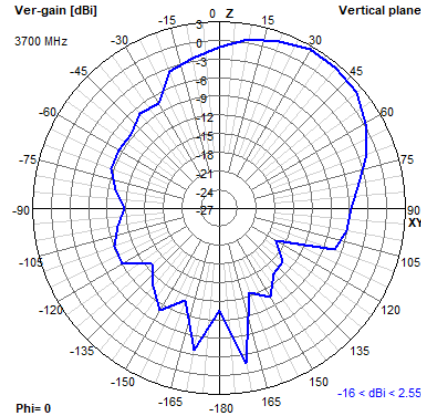

YZ

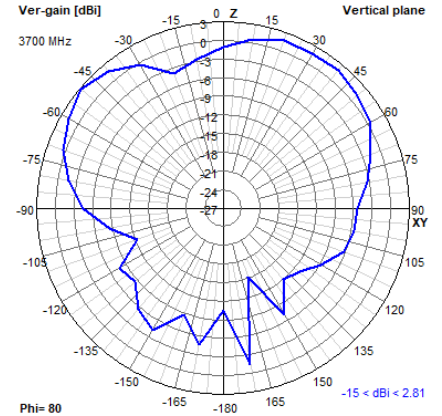

4700 MHz XY

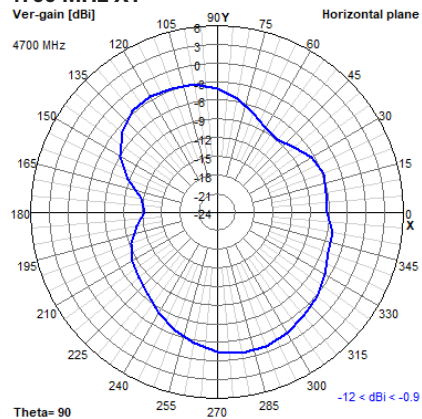

XZ

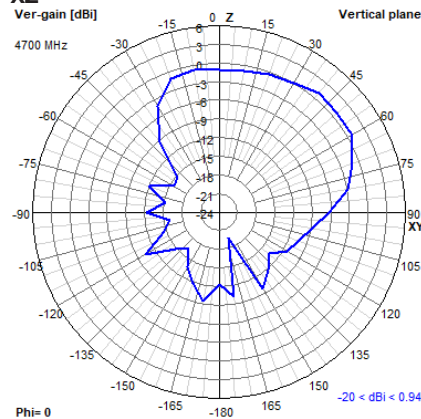

YZ

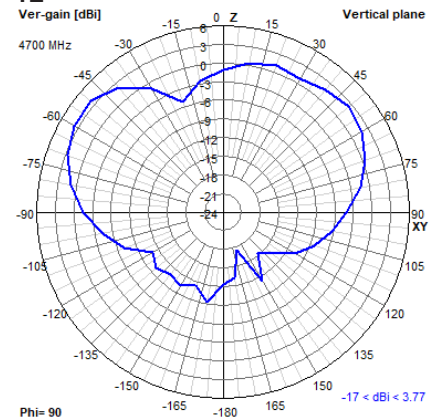



Tango 11A

ISM & Dual-Band Wi-Fi/5G,4G Through Hole Puck Antenna

2D Radiation Plots

5200 MHz XY

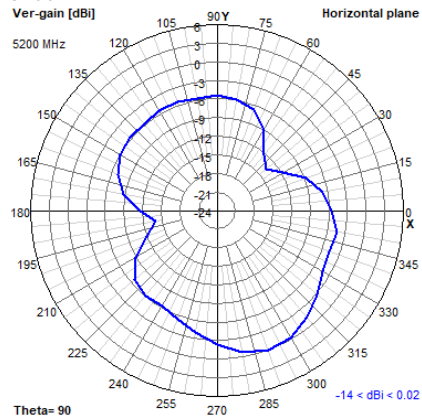

XZ

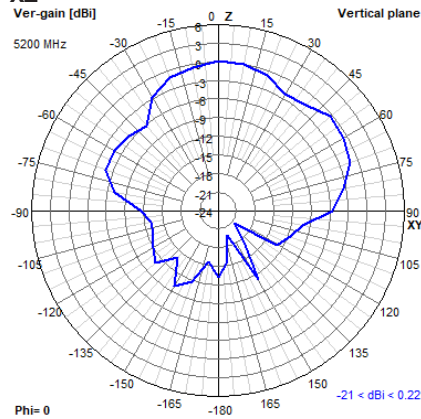

YZ

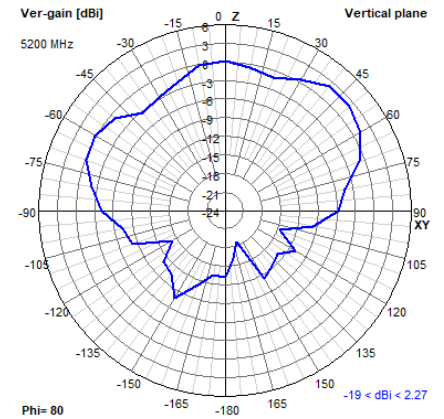

5500 MHz XY

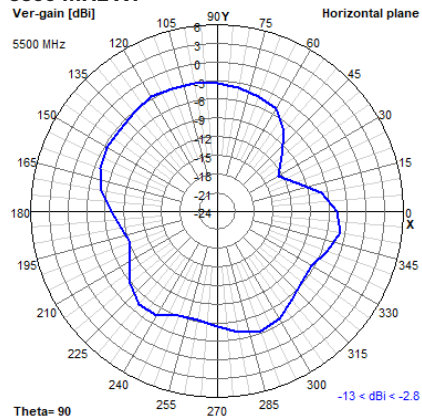

XZ

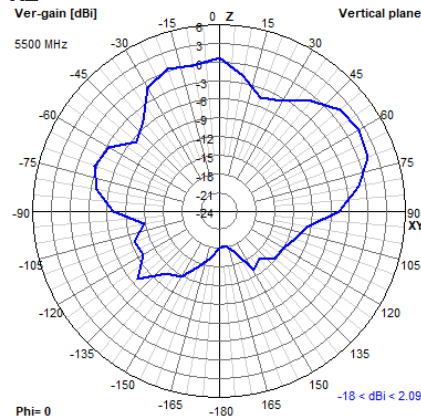

YZ

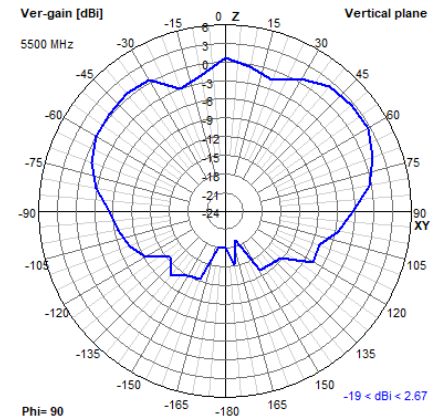

5800 MHz XY

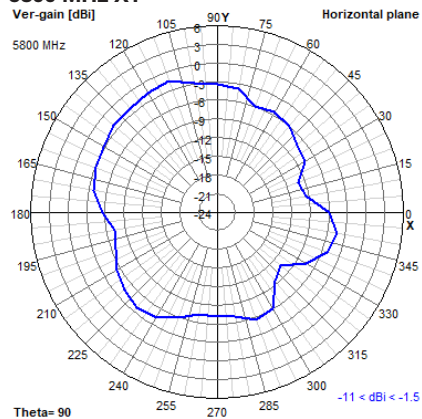

XZ

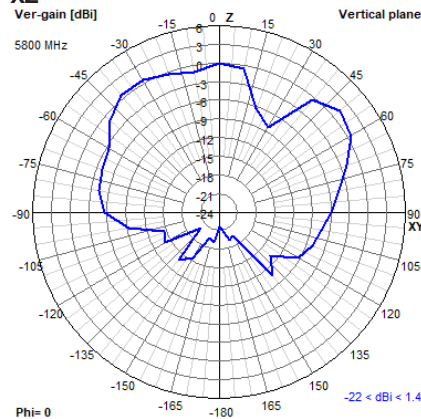

YZ

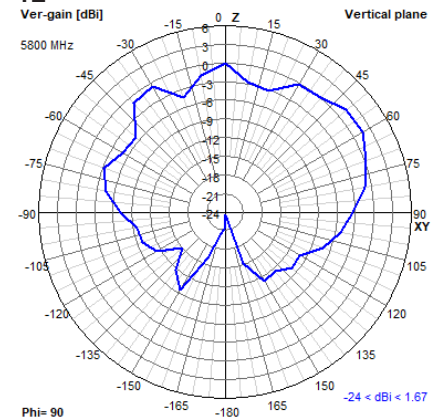



Tango 11A

ISM & Dual-Band Wi-Fi/5G,4G Through Hole Puck Antenna

2D Radiation Plots

5900 MHz XY

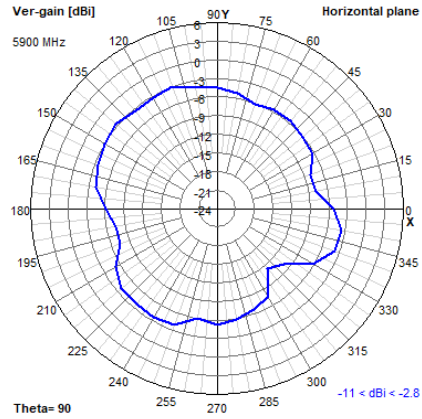

XZ

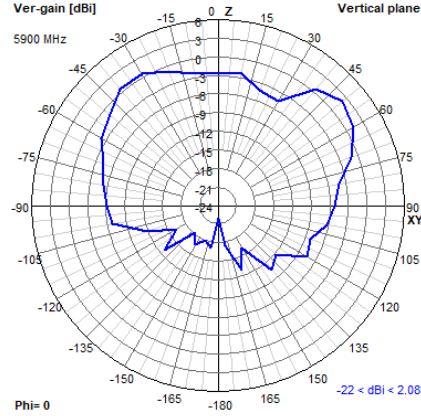

YZ

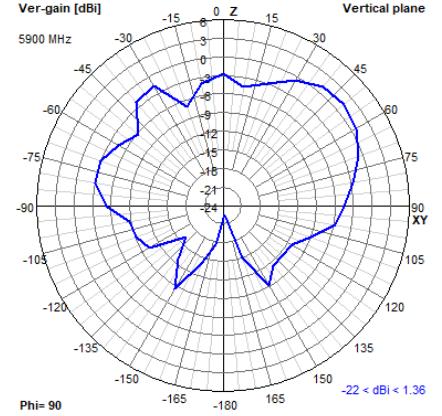



Tango 11A

ISM & Dual-Band Wi-Fi/5G,4G Through Hole Puck Antenna

3D Radiation Plots

600 MHz

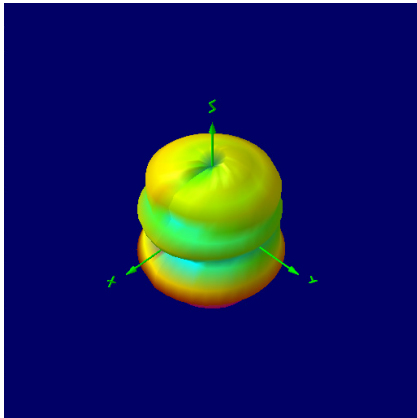

700 MHz

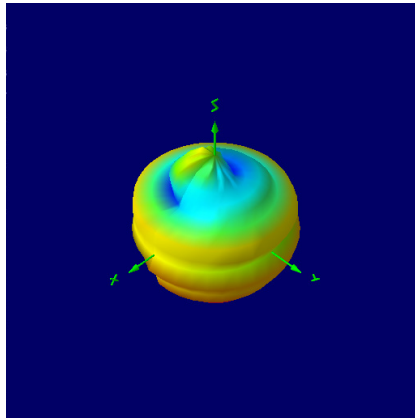

800 MHz

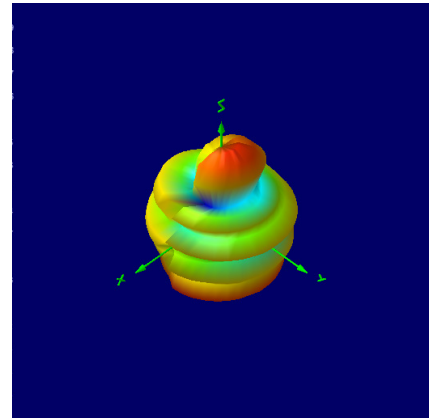

1500 MHz

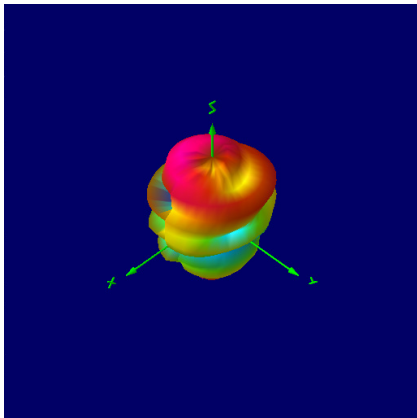

1600 MHz

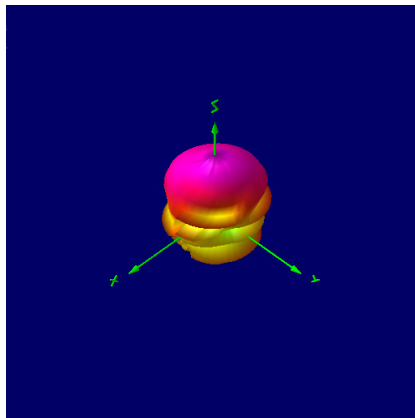

1700 MHz

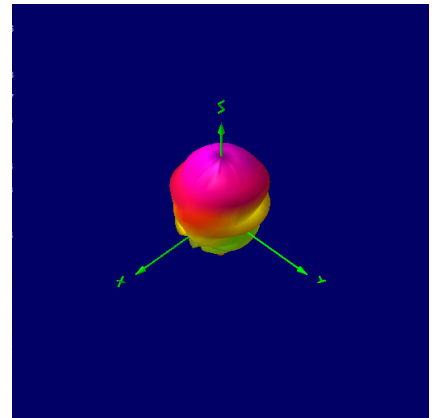

1800 MHz

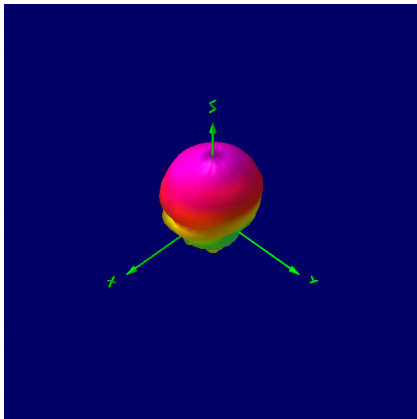

1900 MHz

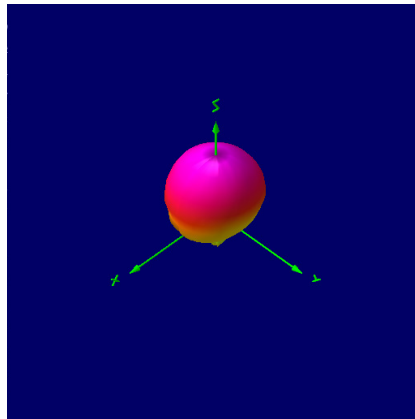

2000 MHz

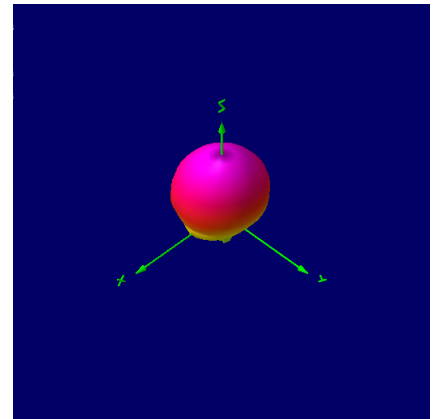



Tango 11A

ISM & Dual-Band Wi-Fi/5G,4G Through Hole Puck Antenna

3D Radiation Plots

2100 MHz

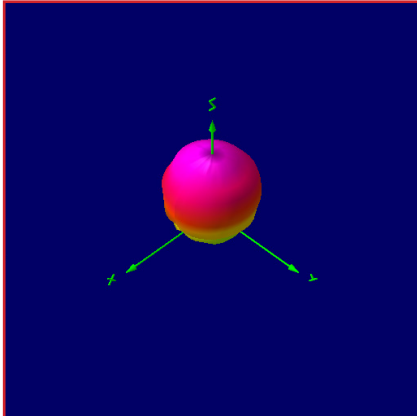

2300 MHz

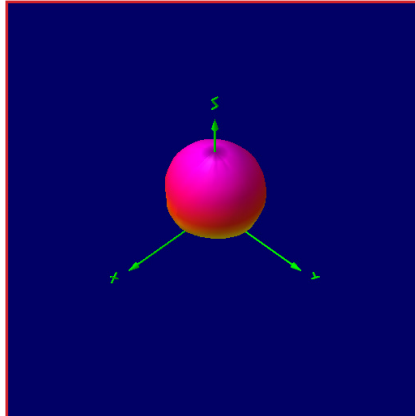

2400 MHz

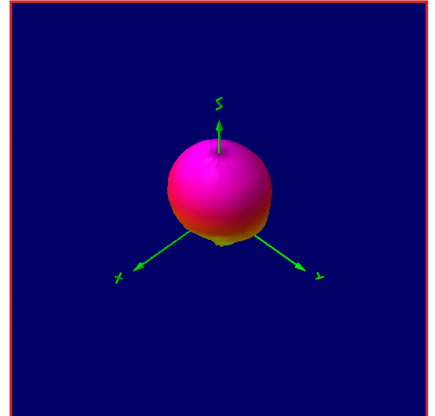

2500 MHz

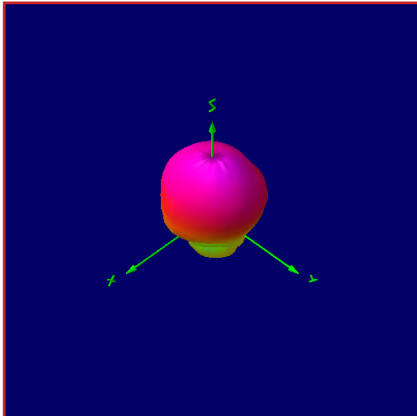

2600 MHz

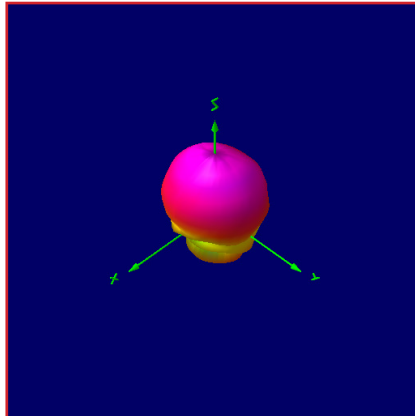

3300 MHz

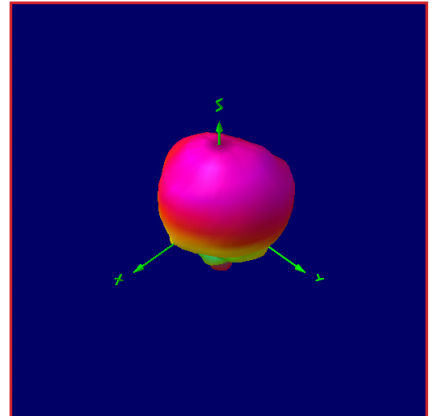

3500 MHz

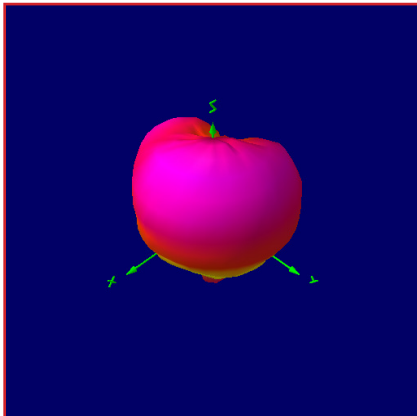

3700 MHz

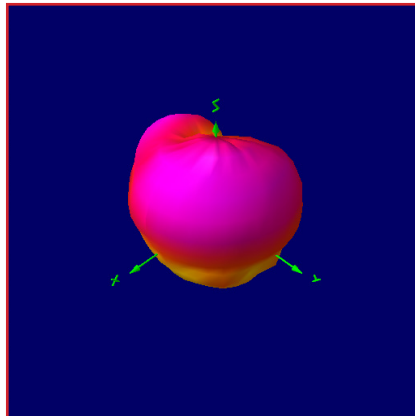

4700 MHz

