

PART NAME

TABLET ENCLOSURE

PART No.

TB-32610-B & TB-32610-W

REV. DATE

2-23-13

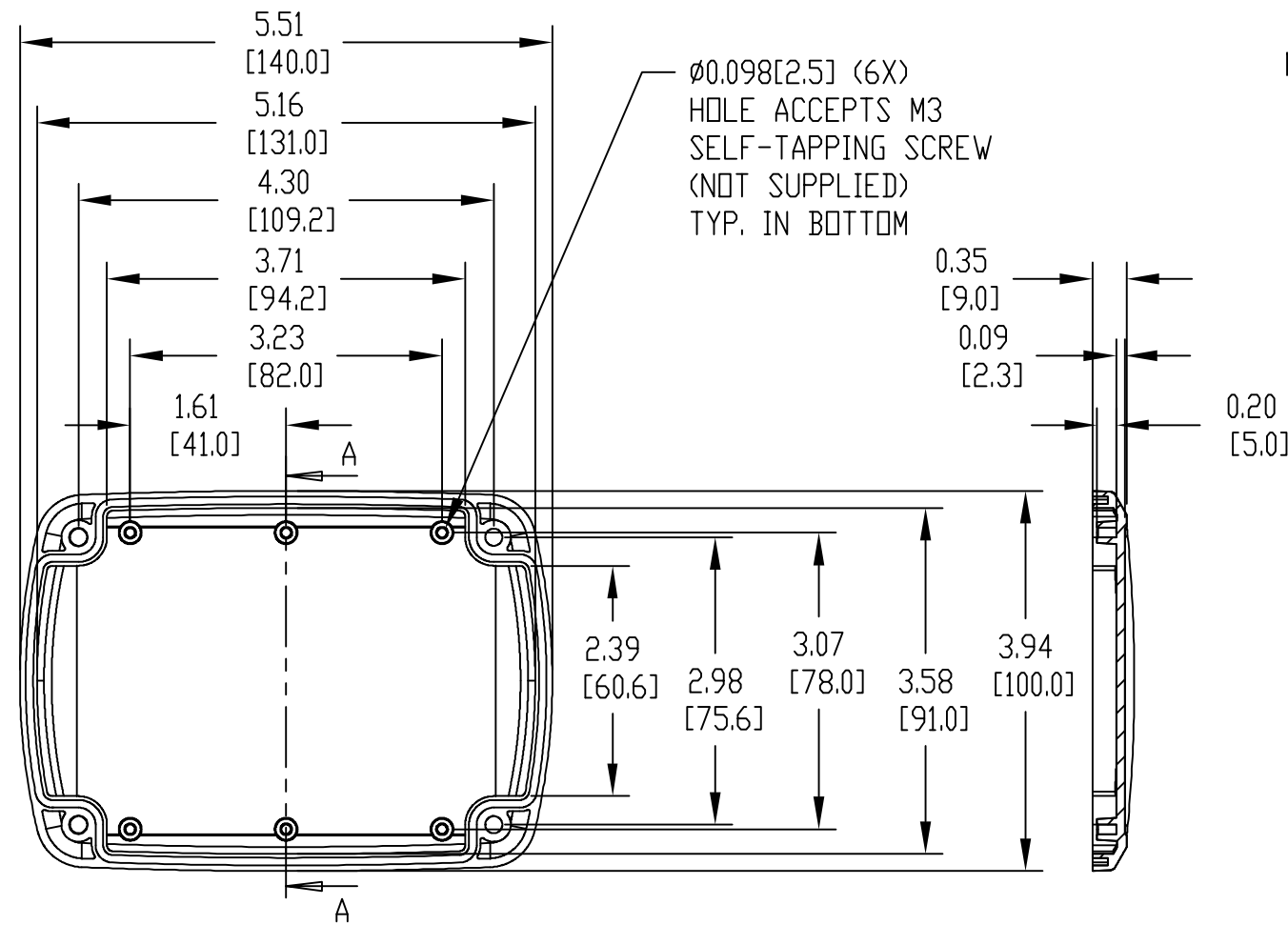

MATERIAL:  
ABS UL94-HB BLACK (SUFFIX -B)  
ABS UL94-V0 WHITE (SUFFIX -W)

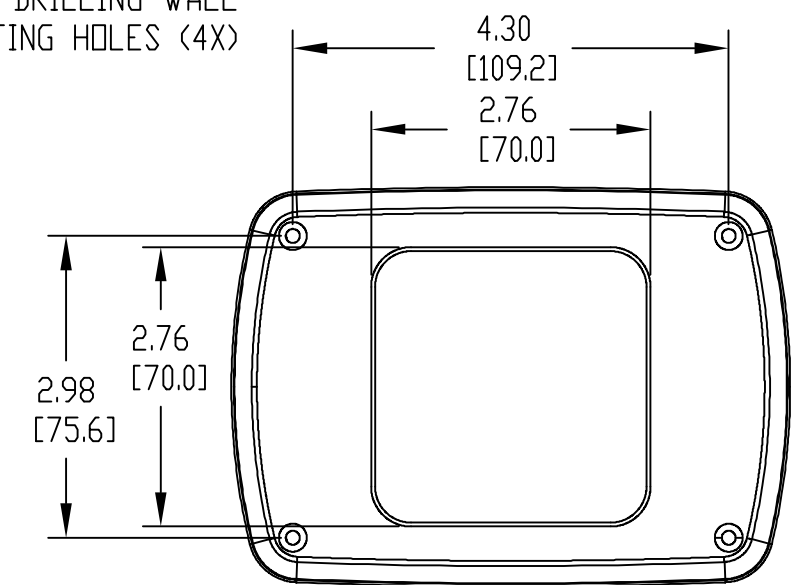
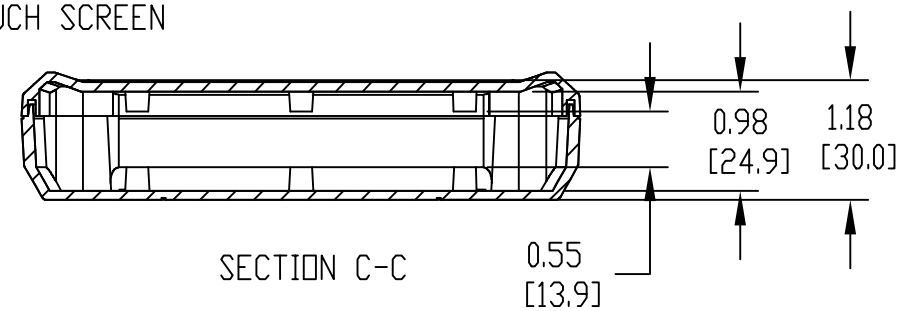
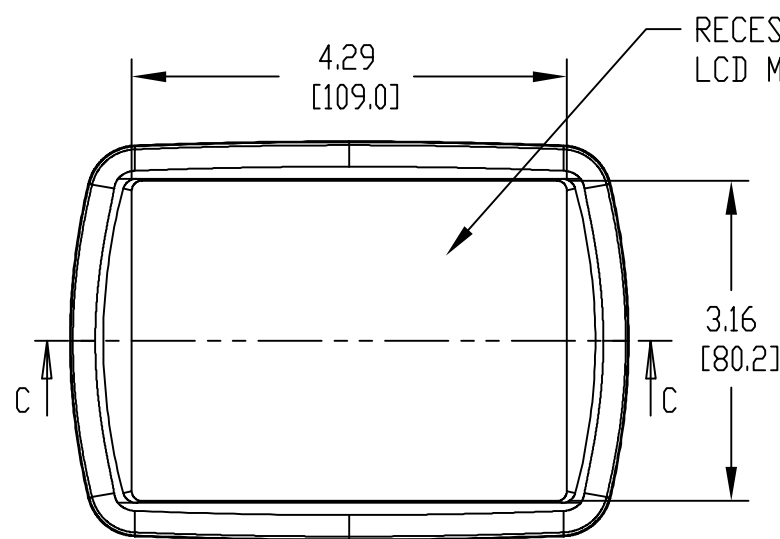
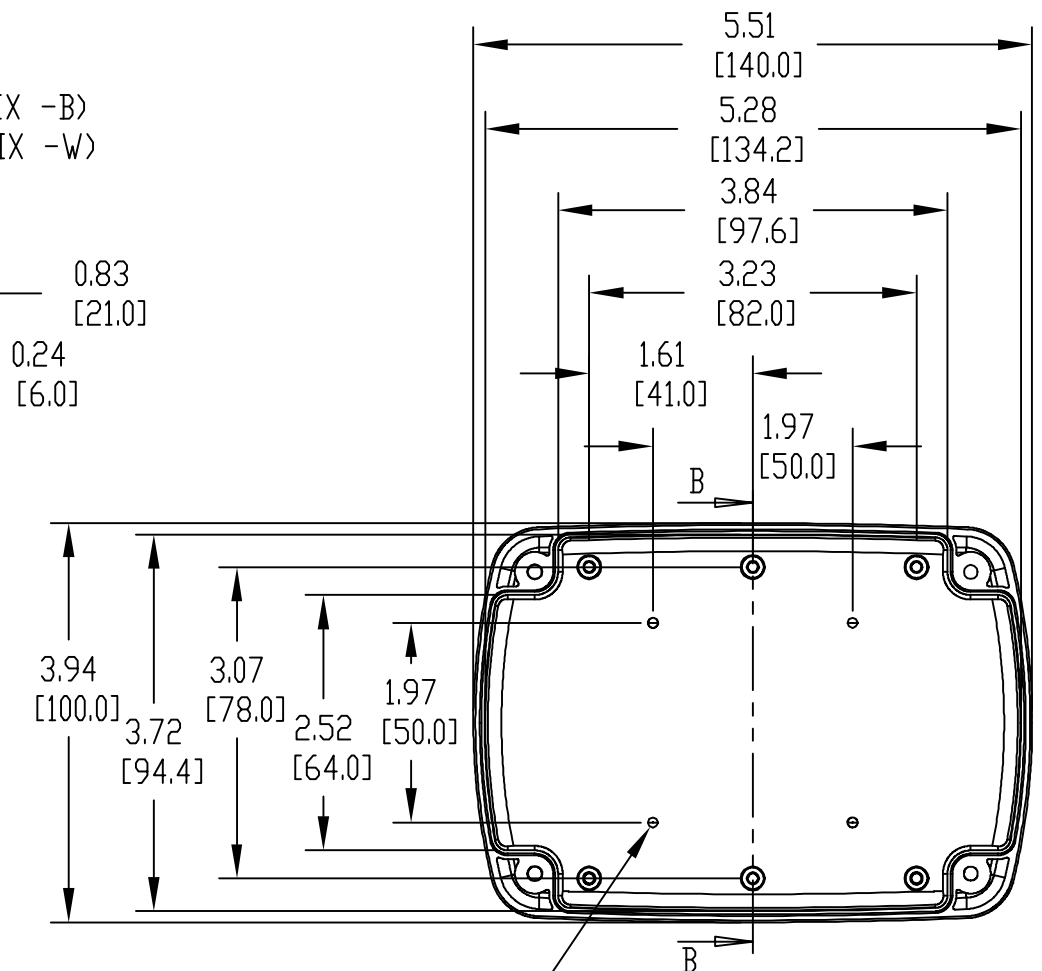
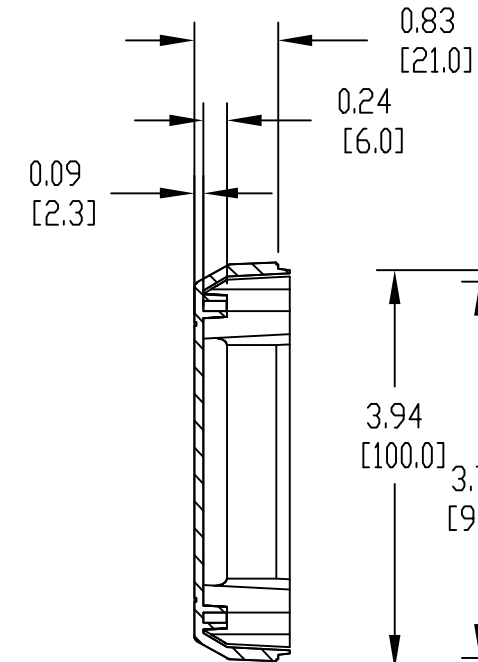

NOTES:

- 1.) FOUR (4) M3 x 0.83[21] LG. SELF-TAPPING SCREWS SUPPLIED FOR ASSEMBLY
- 2.) FOUR (4) ADD-ON RUBBER FEET SUPPLIED
- 3.) ALL HOLE DIAMETERS HAVE ±0.005[0.13] TOLERANCE  
ALL OTHER DIMENSIONS HAVE ±0.015[0.38] TOLERANCE
- 4.) DIMENSIONS ARE INCH[MILLIMETER] - THIRD ANGLE PROJECTION
- 5.) OPTIONAL SILICONE SPONGE GASKET #TB-32610-GSK AVAILABLE