

## Technische Information / technical information



**Netz-Thyristor-Modul**  
**Phase Control Thyristor Module**

# TT430N

Infineon Technologies Bipolar  
GmbH & Co. KG

### Key Parameters

$V_{DRM} / V_{RRM}$	2200 V
$I_{TAVM}$	430 A ( $T_C=85\text{ °C}$ )
$I_{TSM}$	14000 A
$V_{T0}$	0,95 V
$r_T$	0,45 m $\Omega$
$R_{thJC}$	0,062 K/W
Base plate	60 mm



For type designation please refer to actual short form catalog

<http://www.ifbip.com/catalog>

### Merkmale

- Druckkontakt-Technologie für hohe Zuverlässigkeit
- Advanced Medium Power Technology (AMPT)
- Industrie-Standard-Gehäuse
- Elektrisch isolierte Bodenplatte

### Features

- Pressure contact technology for high reliability
- Advanced Medium Power Technology (AMPT)
- Industrial standard package
- Electrically insulated base plate

### Typische Anwendungen

- Sanftanlasser
- Gleichrichter für Antriebsapplikationen
- Kurzschließer-Applikationen
- Leistungssteller
- Gleichrichter für UPS
- Batterieladegleichrichter
- Statische Umschalter
- Bypass-Schalter

### Typical Applications

- Soft starter
- Rectifier for drives applications
- Crowbar applications
- Power controllers
- Rectifiers for UBS
- Battery chargers
- Static switches
- Bypass swich



content of customer DMX code	DMX code digit	DMX code digit quantity
serial number	1..5	5
SAP material number	6..12	7
Internal production order number	13..20	8
datecode (production year)	21..22	2
datecode (production week)	23..24	2

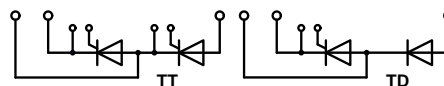

[www.ifbip.com](http://www.ifbip.com)  
[support@infineon-bip.com](mailto:support@infineon-bip.com)

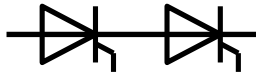

## Technische Information / technical information



**Netz-Thyristor-Modul**  
**Phase Control Thyristor Module**

# TT430N

Infineon Technologies Bipolar  
GmbH & Co. KG

### Elektrische Eigenschaften / Electrical properties

Höchstzulässige Werte / Maximum rated values

TT430N

TD430N

	TT430N	TD430N		
Periodische Vorwärts- und Rückwärts-Spitzensperrspannung repetitive peak forward off-state and reverse voltages	$T_{vj} = -40^{\circ}\text{C} \dots T_{vj \max}$	$V_{\text{DRM}}, V_{\text{RRM}}$	2200	V
Vorwärts-Stoßspitzensperrspannung non-repetitive peak forward off-state voltage	$T_{vj} = -40^{\circ}\text{C} \dots T_{vj \max}$	$V_{\text{DSM}}$	2200	V
Rückwärts-Stoßspitzensperrspannung non-repetitive peak reverse voltage	$T_{vj} = +25^{\circ}\text{C} \dots T_{vj \max}$	$V_{\text{RSM}}$	2300	V
Durchlaßstrom-Grenzeffektivwert maximum RMS on-state current		$I_{\text{TRMSM}}$	800	A
Dauergrenzstrom average on-state current	$T_C = 85^{\circ}\text{C}$	$I_{\text{TAVM}}$	430	A
Stoßstrom-Grenzwert surge current	$T_{vj} = 25^{\circ}\text{C}, t_p = 10\text{ms}$ $T_{vj} = T_{vj \max}, t_p = 10\text{ms}$	$I_{\text{TSM}}$	14000 12000	A A
Grenzlastintegral $I^2t$ -value	$T_{vj} = 25^{\circ}\text{C}, t_p = 10\text{ms}$ $T_{vj} = T_{vj \max}, t_p = 10\text{ms}$	$I^2t$	980000 720000	$\text{A}^2\text{s}$ $\text{A}^2\text{s}$
Kritische Stromsteilheit critical rate of rise of on-state current	DIN IEC 747-6 $f = 50\text{Hz}, i_{\text{GM}} = 1\text{A}, di_{\text{G}}/dt = 1\text{A}/\mu\text{s}$	$(di_{\text{T}}/dt)_{\text{cr}}$	150	$\text{A}/\mu\text{s}$
Kritische Spannungssteilheit critical rate of rise of off-state voltage	$T_{vj} = T_{vj \max}, V_{\text{D}} = 0,67 V_{\text{DRM}}$ 6.Kennbuchstabe / 6 <sup>th</sup> letter F	$(dv_{\text{D}}/dt)_{\text{cr}}$	1000	$\text{V}/\mu\text{s}$

### Charakteristische Werte / Characteristic values

Durchlaßspannung on-state voltage	$T_{vj} = T_{vj \max}, i_{\text{T}} = 1500\text{A}$	$V_{\text{T}}$	max. 1,78	V
Schleusenspannung threshold voltage	$T_{vj} = T_{vj \max}$	$V_{(\text{TO})}$	max. 0,95	V
Ersatzwiderstand slope resistance	$T_{vj} = T_{vj \max}$	$r_{\text{T}}$	max. 0,45	$\text{m}\Omega$
Zündstrom gate trigger current	$T_{vj} = 25^{\circ}\text{C}, V_{\text{D}} = 12\text{V}$	$I_{\text{GT}}$	max. 250	mA
Zündspannung gate trigger voltage	$T_{vj} = 25^{\circ}\text{C}, V_{\text{D}} = 12\text{V}$	$V_{\text{GT}}$	max. 2,2	V
Nicht zündender Steuerstrom gate non-trigger current	$T_{vj} = T_{vj \max}, V_{\text{D}} = 12\text{V}$ $T_{vj} = T_{vj \max}, V_{\text{D}} = 0,5 V_{\text{DRM}}$	$I_{\text{GD}}$	max. 10 max. 5	mA mA
Nicht zündende Steuerspannung gate non-trigger voltage	$T_{vj} = T_{vj \max}, V_{\text{D}} = 0,5 V_{\text{DRM}}$	$V_{\text{GD}}$	max. 0,25	V
Haltestrom holding current	$T_{vj} = 25^{\circ}\text{C}, V_{\text{D}} = 12\text{V}, R_{\text{A}} = 1\Omega$	$I_{\text{H}}$	max. 300	mA
Einraststrom latching current	$T_{vj} = 25^{\circ}\text{C}, V_{\text{D}} = 12\text{V}, R_{\text{GK}} \geq 10\Omega$ $i_{\text{GM}} = 1\text{A}, di_{\text{G}}/dt = 1\text{A}/\mu\text{s}, t_{\text{g}} = 20\mu\text{s}$	$I_{\text{L}}$	max. 1500	mA
Vorwärts- und Rückwärts-Sperrstrom forward off-state and reverse current	$T_{vj} = T_{vj \max}$ $V_{\text{D}} = V_{\text{DRM}}, V_{\text{R}} = V_{\text{RRM}}$	$i_{\text{D}}, i_{\text{R}}$	max. 100	mA
Zündverzug gate controlled delay time	DIN IEC 747-6 $T_{vj} = 25^{\circ}\text{C}, i_{\text{GM}} = 1\text{A}, di_{\text{G}}/dt = 1\text{A}/\mu\text{s}$	$t_{\text{gd}}$	max. 4	$\mu\text{s}$

prepared by:	HR	date of publication:	2014-04-14
approved by:	ML	revision:	3.4

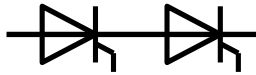

## Technische Information / technical information



**Netz-Thyristor-Modul**  
**Phase Control Thyristor Module**

# TT430N

Infineon Technologies Bipolar  
GmbH & Co. KG

### Elektrische Eigenschaften / Electrical properties

Charakteristische Werte / Characteristic values

Freiwerdezeit circuit commutated turn-off time	$T_{vj} = T_{vj\ max}$ , $i_{TM} = I_{TAVM}$ $V_{RM} = 100\ V$ , $v_{DM} = 0,67\ V_{DRM}$ $dv_D/dt = 20\ V/\mu s$ , $-di_T/dt = 10\ A/\mu s$ 5.Kennbuchstabe / 5 <sup>th</sup> letter O	$t_q$	typ.	300	$\mu s$
Isolations-Prüfspannung insulation test voltage	RMS, $f = 50\ Hz$ , $t = 1\ min$ RMS, $f = 50\ Hz$ , $t = 1\ sec$	$V_{ISOL}$		3,0 3,6	kV kV

### Thermische Eigenschaften / Thermal properties

Innerer Wärmewiderstand thermal resistance, junction to case	pro Modul / per Module, $\Theta = 180^\circ\ sin$ pro Zweig / per arm, $\Theta = 180^\circ\ sin$ pro Modul / per Module, DC pro Zweig / per arm, DC	$R_{thJC}$	max.	0,0325	K/W
			max.	0,0650	K/W
			max.	0,0310	K/W
			max.	0,0620	K/W
Übergangs-Wärmewiderstand thermal resistance, case to heatsink	pro Modul / per Module pro Zweig / per arm	$R_{thCH}$	max.	0,010	K/W
			max.	0,020	K/W
Höchstzulässige Sperrschichttemperatur maximum junction temperature		$T_{vj\ max}$		125	$^\circ C$
Betriebstemperatur operating temperature		$T_{c\ op}$		-40...+125	$^\circ C$
Lagertemperatur storage temperature		$T_{stg}$		-40...+130	$^\circ C$

### Mechanische Eigenschaften / Mechanical properties

Gehäuse, siehe Anlage case, see annex				Seite 4 page 4	
Si-Element mit Druckkontakt Si-pellet with pressure contact					
Innere Isolation internal insulation	Basisisolierung (Schutzklasse 1, EN61140) Basic insulation (class 1, IEC61140)			AIN	
Anzugsdrehmoment für mechanische Anschlüsse mounting torque	Toleranz / Tolerance $\pm 15\%$	M1		6	Nm
Anzugsdrehmoment für elektrische Anschlüsse terminal connection torque	Toleranz / Tolerance $\pm 10\%$	M2		12	Nm
Steueranschlüsse control terminals	DIN 46 244			A 2,8 x 0,8	
Gewicht weight		G	typ.	1500	g
Kriechstrecke creepage distance				19	mm
Schwingfestigkeit vibration resistance	$f = 50\ Hz$			50	$m/s^2$
	file-No.			E 83335	



Technische Information /  
technical information



Netz-Thyristor-Modul  
Phase Control Thyristor Module

**TT430N**

Infineon Technologies Bipolar  
GmbH & Co. KG

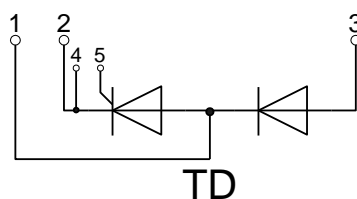
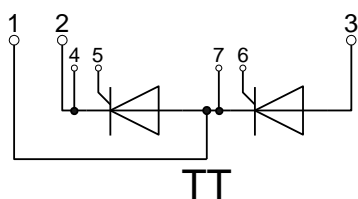
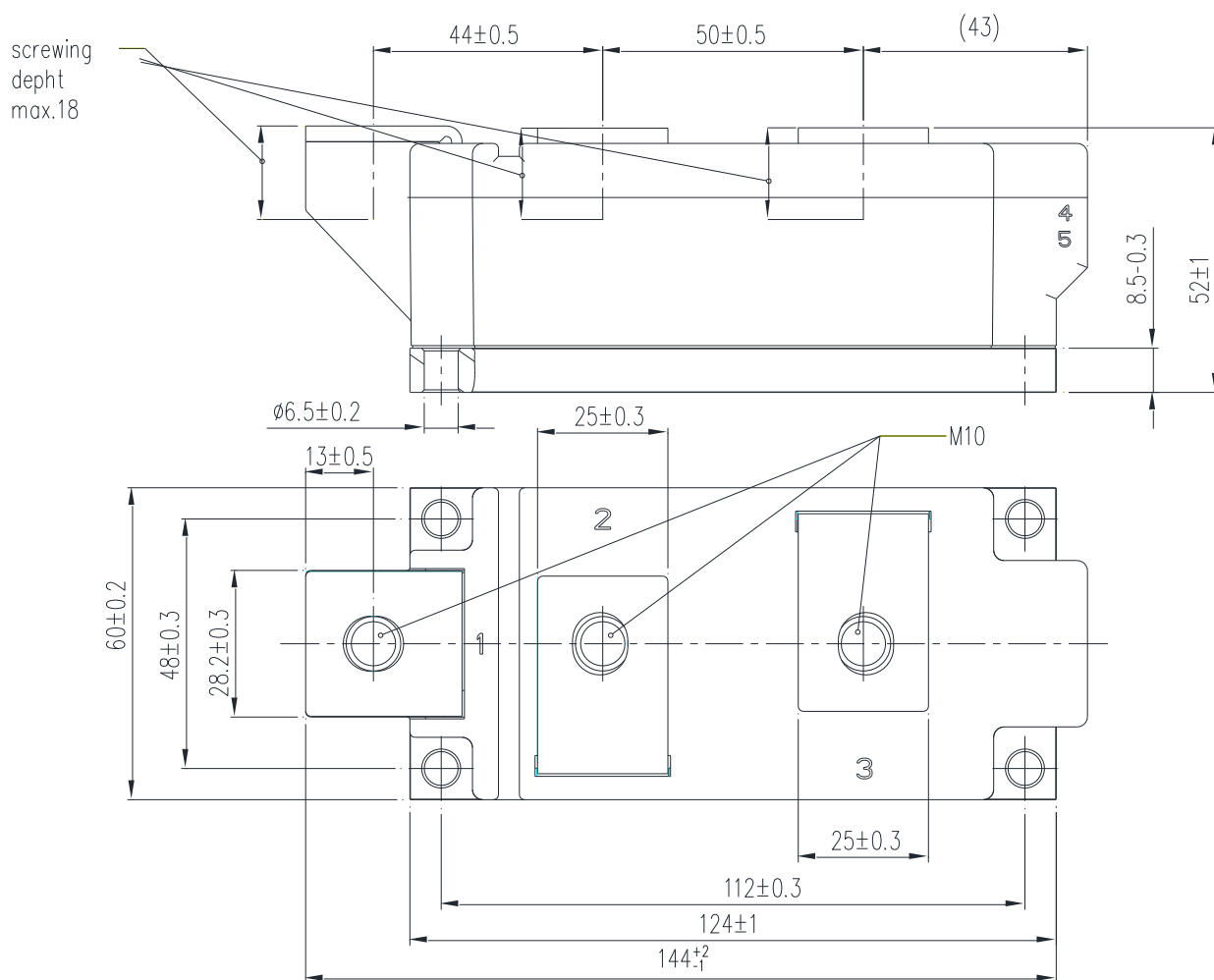

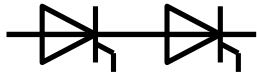

Technische Information /  
technical information



Netz-Thyristor-Modul  
Phase Control Thyristor Module

**TT430N**

Infineon Technologies Bipolar  
GmbH & Co. KG

Analytische Elemente des transienten Wärmewiderstandes  $Z_{thJC}$  für DC  
Analytical elements of transient thermal impedance  $Z_{thJC}$  for DC

Pos. n	1	2	3	4	5	6	7
$R_{thn}$ [K/W]	0,0221	0,0223	0,0114	0,00486	0,00137		
$\tau_n$ [s]	3,12	0,56	0,101	0,0086	0,00076		

Analytische Funktion / Analytical function:

$$Z_{thJC} = \sum_{n=1}^{n_{max}} R_{thn} \left( 1 - e^{-\frac{t}{\tau_n}} \right)$$

Erhöhung des  $Z_{thDC}$  bei Sinus und Rechteckströmen mit unterschiedlichen Stromflusswinkeln  $\Theta$   
Rise of  $Z_{thDC}$  for sinewave and rectangular current with different current conduction angles  $\Theta$   
 $\Delta Z_{th \Theta rec} / \Delta Z_{th \Theta sin}$

	$\Theta = 180^\circ$	$\Theta = 120^\circ$	$\Theta = 90^\circ$	$\Theta = 60^\circ$	$\Theta = 30^\circ$
$\Delta Z_{th \Theta rec}$ [K/W]	0,00471	0,00766	0,00995	0,01370	0,02127
$\Delta Z_{th \Theta sin}$ [K/W]	0,00277	0,00396	0,00553	0,00841	0,01586

$$Z_{th \Theta rec} = Z_{thDC} + \Delta Z_{th \Theta rec}$$

$$Z_{th \Theta sin} = Z_{thDC} + \Delta Z_{th \Theta sin}$$

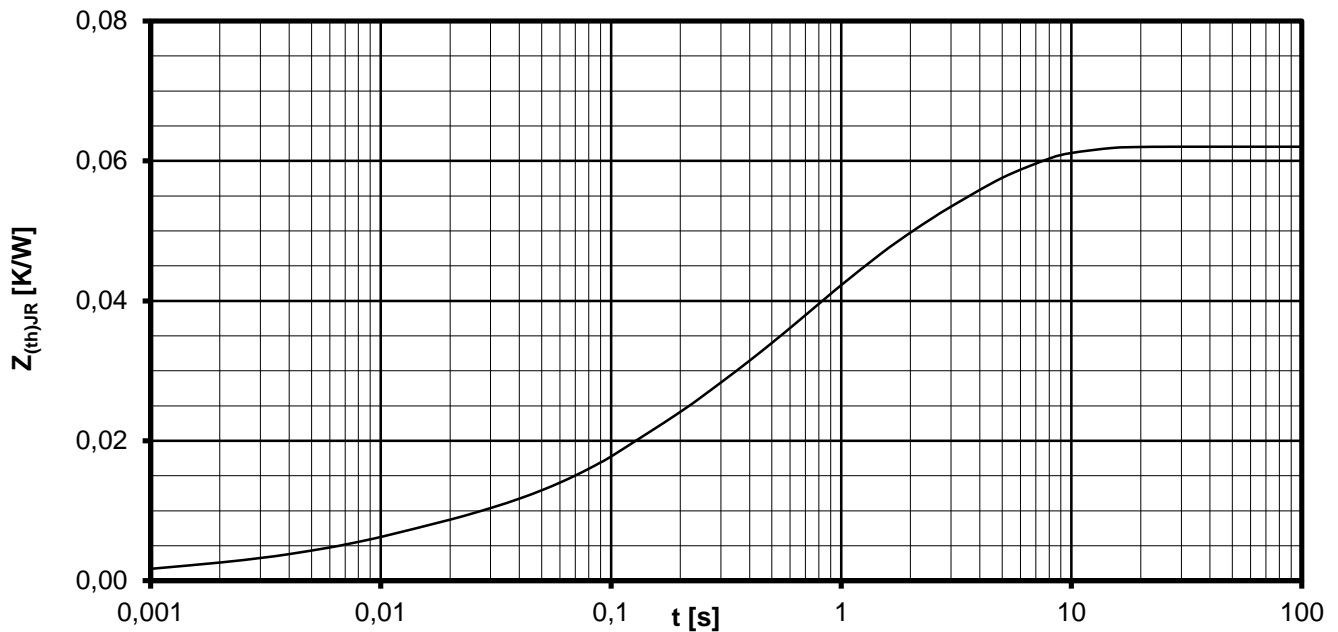
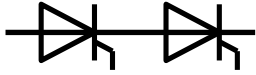

Transienter innerer Wärmewiderstand je Zweig / Transient thermal impedance per arm  $Z_{thJC} = f(t)$

Sinusförmiger Strom / Sinusoidal current

Parameter: Stromflußwinkel  $\Theta$  / Current conduction angle  $\Theta$

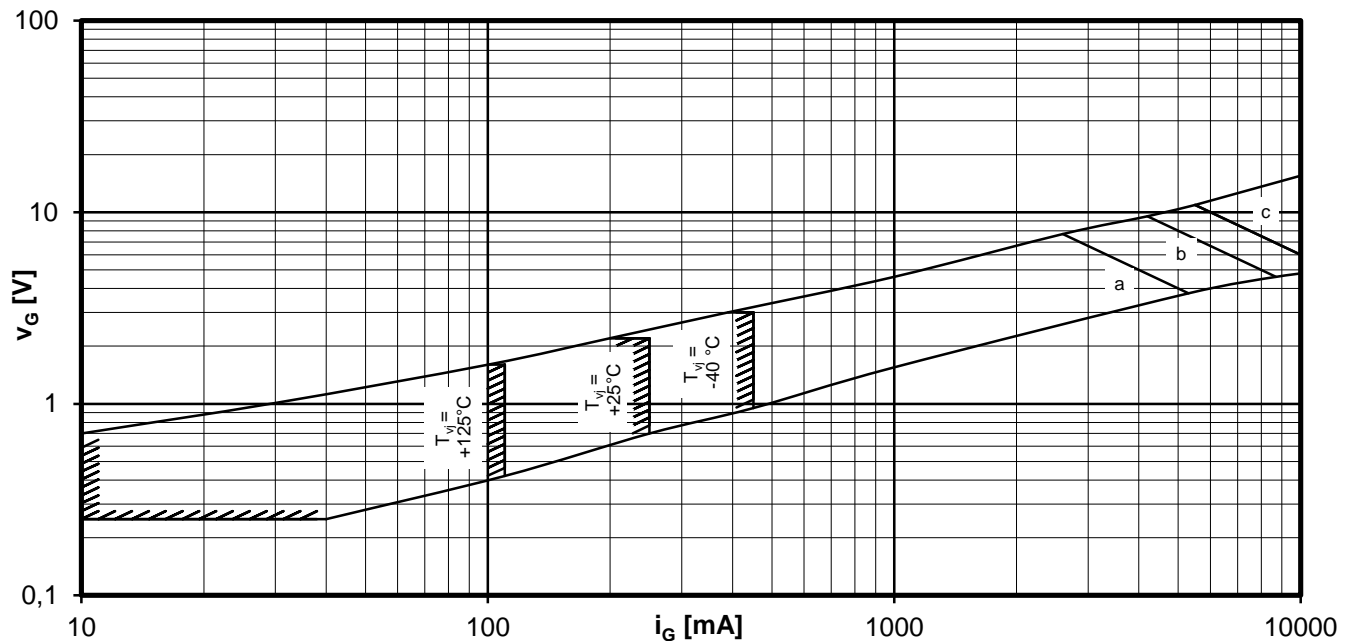

Steuercharakteristik  $v_G = f(i_G)$  mit Zündbereichen für  $V_D = 12\text{ V}$   
Gate characteristic  $v_G = f(i_G)$  with triggering area for  $V_D = 12\text{ V}$

Höchstzulässige Spitzensteuerverlustleistung / Maximum rated peak gate power dissipation  $P_{GM} = f(t_g)$  :

a - 20W/10ms    b - 40W/1ms    c - 60W/0,5ms

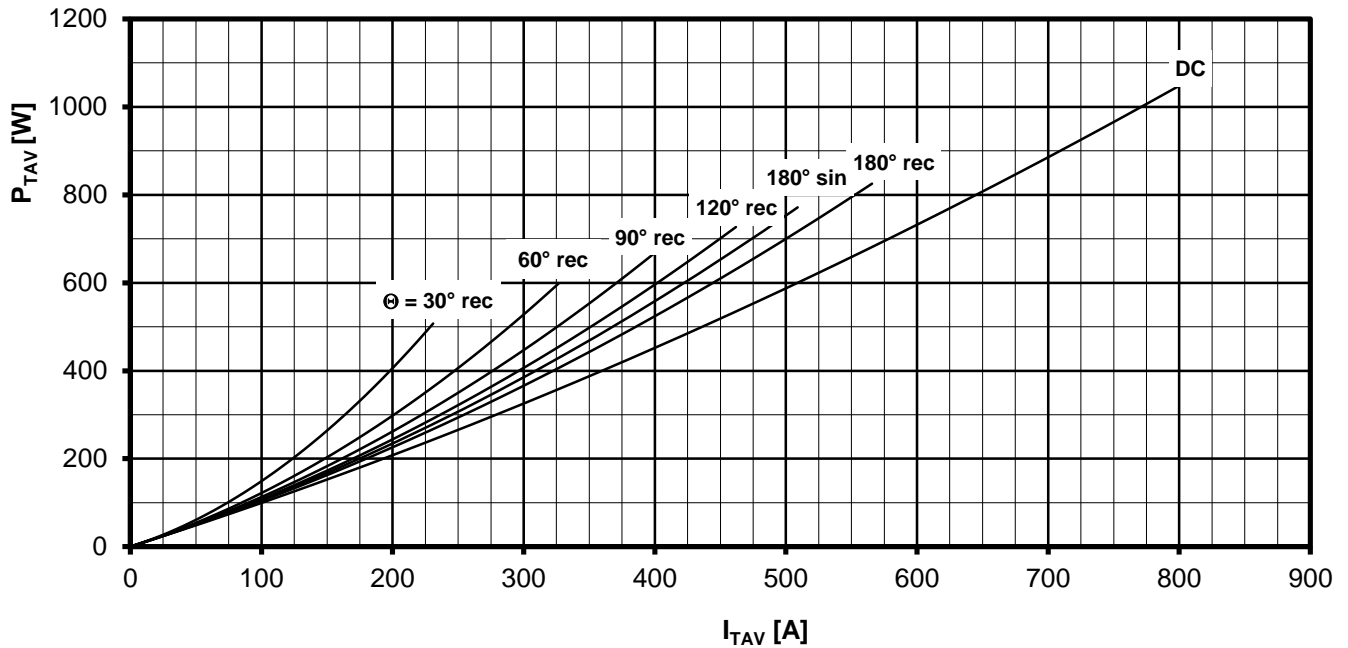
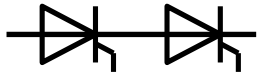

Durchlassverlustleistung je Zweig / On-state power loss per arm  $P_{TAV} = f(I_{TAV})$

Strombelastung je Zweig / Current load per arm

Berechnungsgrundlage  $P_{TAV}$  (Schaltverluste gesondert berücksichtigen)  
Calculation base  $P_{TAV}$  (switching losses should be considered separately)

Parameter: Stromflußwinkel / Current conduction angle  $\Theta$

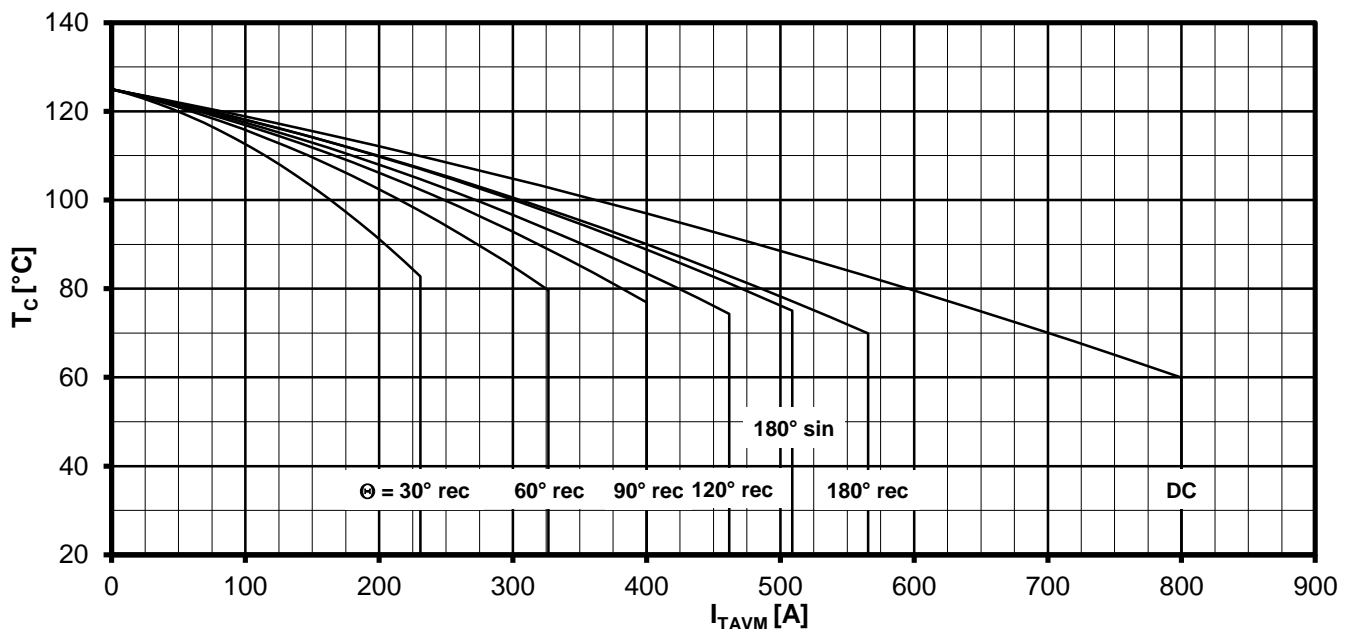

Höchstzulässige Gehäusetemperatur / Maximum allowable case temperature  $T_C = f(I_{TAVM})$

Strombelastung je Zweig / Current load per arm

Berechnungsgrundlage  $P_{TAV}$  (Schaltverluste gesondert berücksichtigen)  
Calculation base  $P_{TAV}$  (switching losses should be considered separately)

Parameter: Stromflußwinkel  $\Theta$  / Current conduction angle  $\Theta$

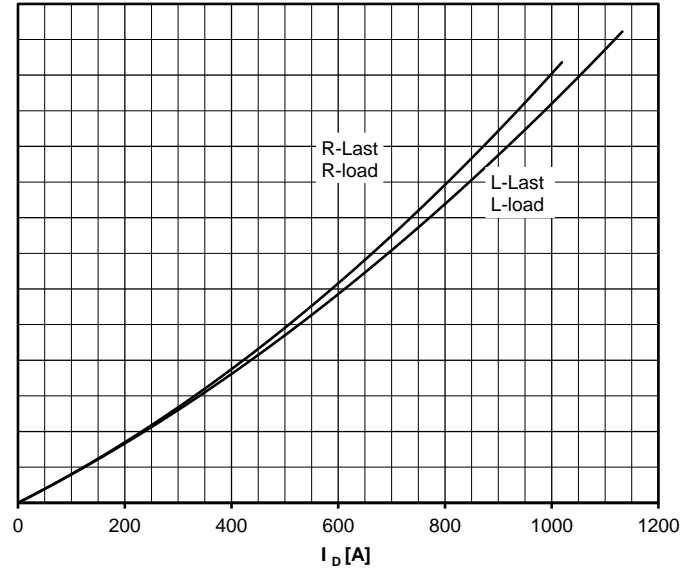
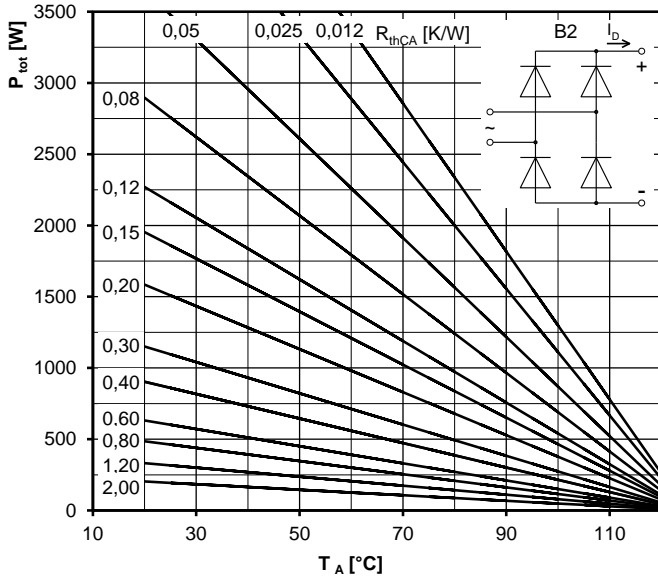
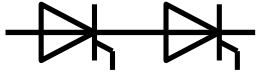

Höchstzulässiger Ausgangsstrom / Maximum rated output current  $I_D$

B2- Zweipuls-Brückenschaltung / Two-pulse bridge circuit

Gesamtverlustleistung der Schaltung / Total power dissipation at circuit  $P_{tot}$

Parameter:

Wärmewiderstand pro Element zwischen den Gehäusen und Umgebung /  
Thermal resistance per chip cases to ambient  $R_{thCA}$

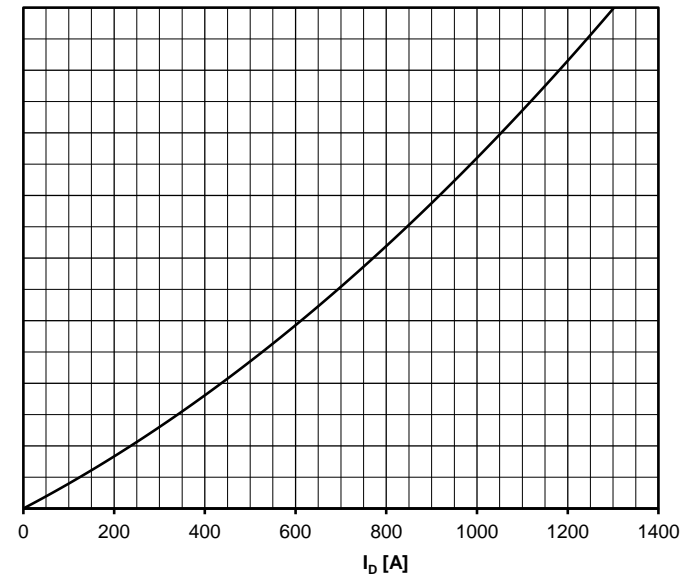
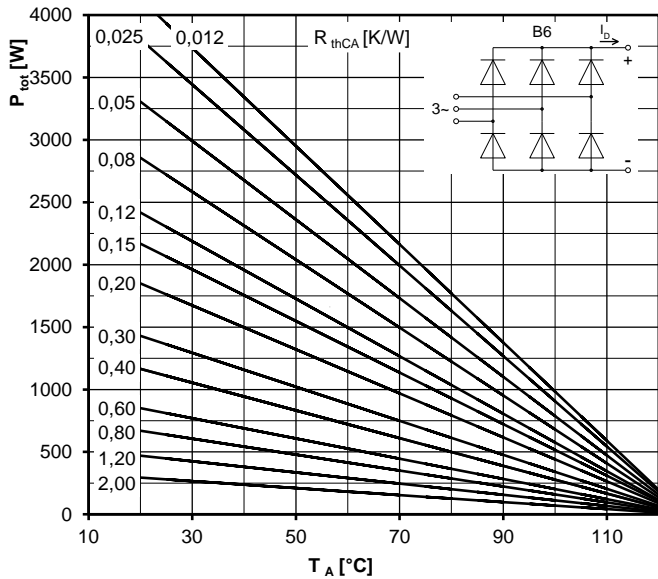

Höchstzulässiger Ausgangsstrom / Maximum rated output current  $I_D$

B6- Sechspuls-Brückenschaltung / Six-pulse bridge circuit

Gesamtverlustleistung der Schaltung / Total power dissipation at circuit  $P_{tot}$

Parameter:

Wärmewiderstand pro Element zwischen den Gehäusen und Umgebung /  
Thermal resistance per chip cases to ambient  $R_{thCA}$



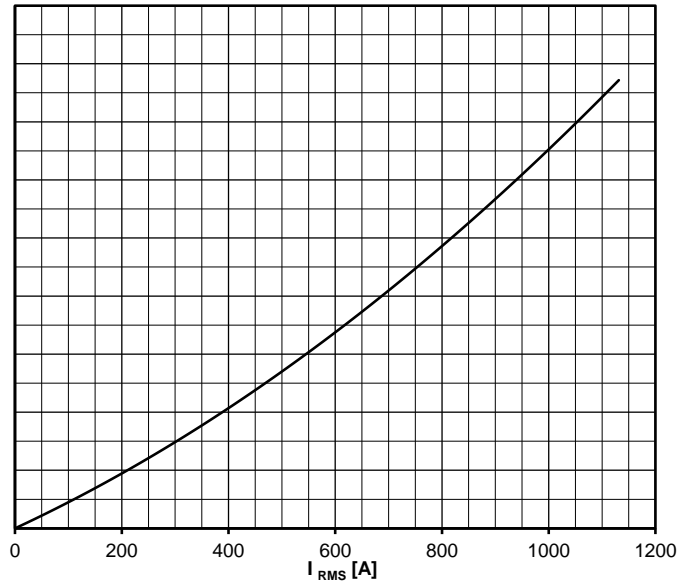
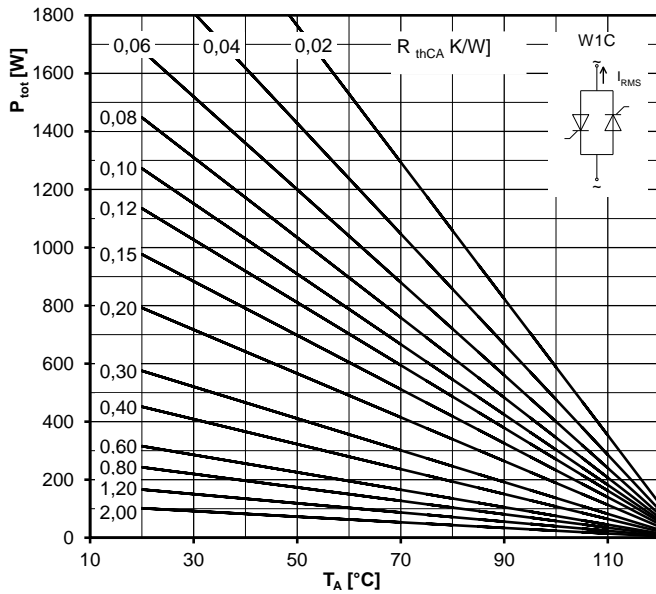
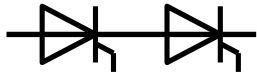

Höchstzulässiger Effektivstrom / Maximum rated RMS current  $I_{RMS}$

W1C - Einphasen-Wechselwegschaltung / Single-phase inverse parallel circuit

Gesamtverlustleistung der Schaltung / Total power dissipation at circuit  $P_{tot}$

Parameter:

Wärmewiderstand pro Element zwischen den Gehäusen und Umgebung /  
Thermal resistance per chip cases to ambient  $R_{thCA}$

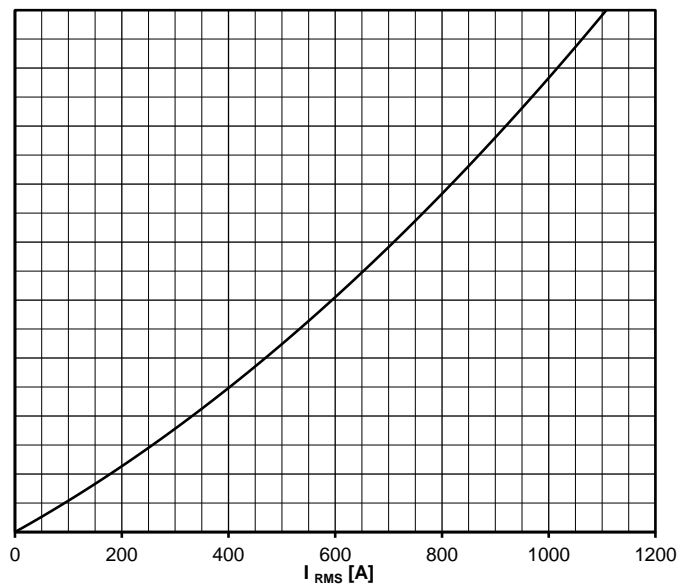
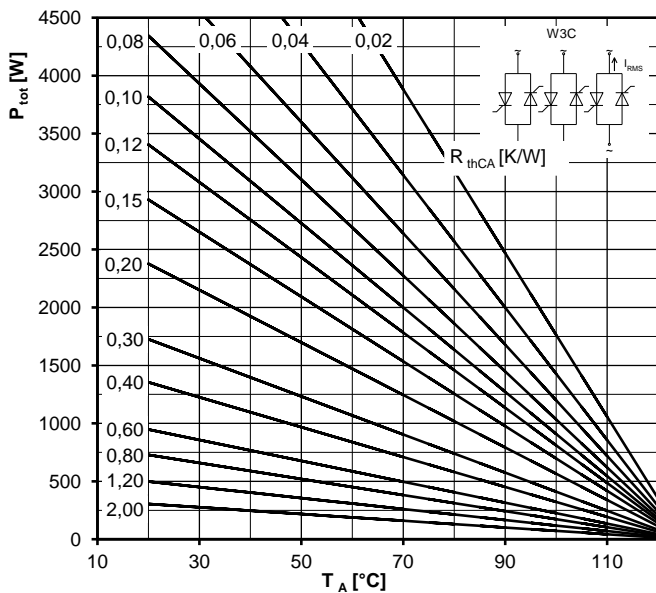

Höchstzulässiger Effektivstrom / Maximum rated RMS current  $I_{RMS}$

W3C - Dreiphasen-Wechselwegschaltung / Three-phase inverse parallel circuit

Gesamtverlustleistung der Schaltung / Total power dissipation at circuit  $P_{tot}$

Parameter:

Wärmewiderstand pro Element zwischen den Gehäusen und Umgebung /  
Thermal resistance per chip cases to ambient  $R_{thCA}$

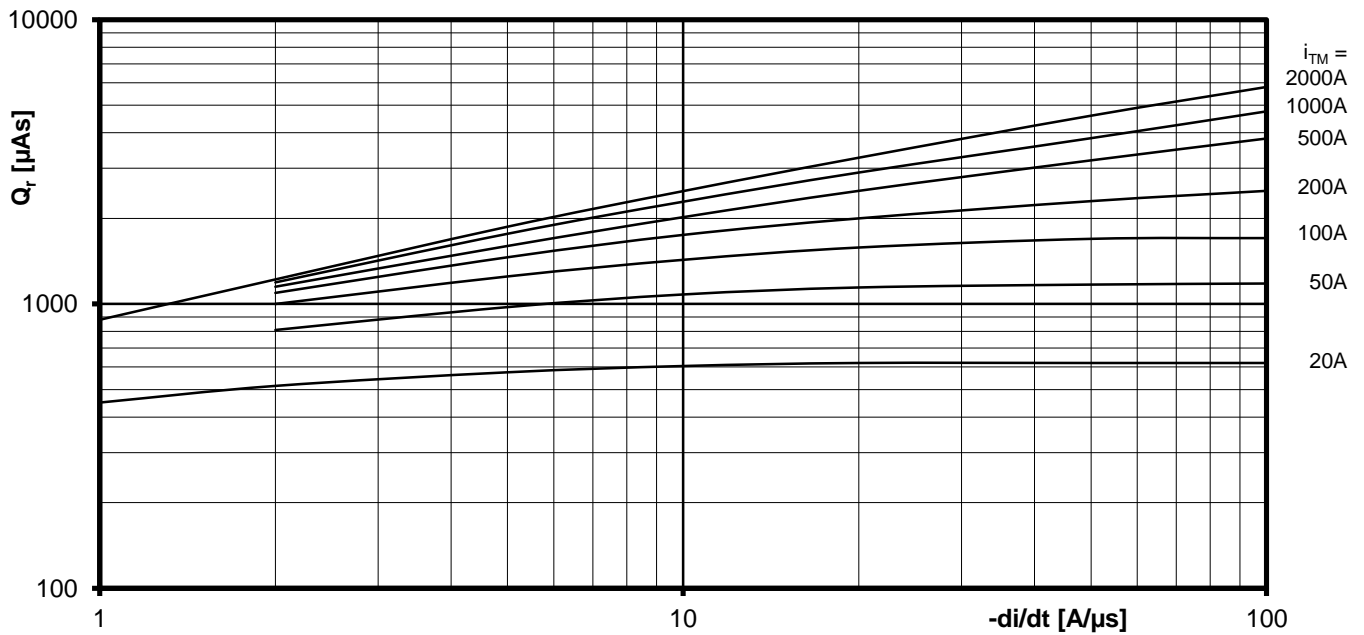
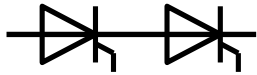

Sperrverzögerungsladung / Recovered charge  $Q_r = f(-di/dt)$

$$T_{vj} = T_{vjmax}, v_R \leq 0,5 V_{RRM}, v_{RM} = 0,8 V_{RRM}$$

Parameter: Durchlaßstrom / On-state current  $i_{TM}$

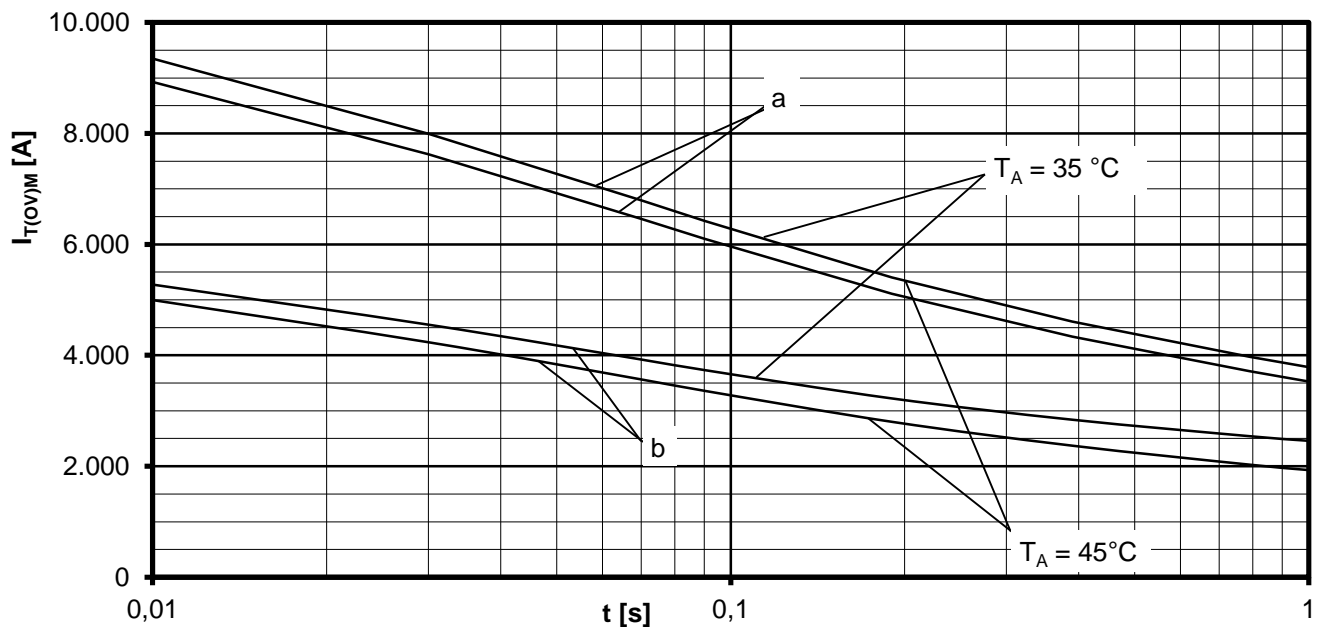

Grenzstrom / Maximum overload on-state current  $I_{T(OV)M} = f(t), v_{RM} = 0,8 V_{RRM}$

a: Leerlauf / No-load conditions

b: nach Belastung mit  $I_{TAVM}$  / after load with  $I_{TAVM}$

$T_A = 35^\circ\text{C}$ , verstärkte Luftkühlung / Forced air cooling

$T_A = 45^\circ\text{C}$ , Luftselbstkühlung / Natural air cooling