

ELITE automotive tuners for AM/FM car-radio

Datasheet - production data

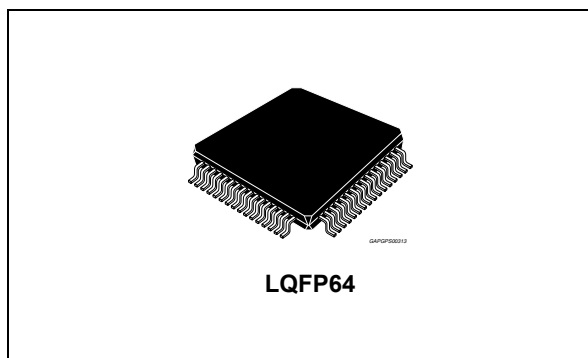

Description

The TDA7786x (ELITE) tuner is an optimized high-performance AM/FM tuner IC family for car-radio applications, suitable also (in combination with an external baseband decoder) for HD Radio™ reception.

Its members integrate mixers and IF amplifiers for AM, FM and WX, fully integrated VCO and PLL synthesizer, IF- processing including adaptive bandwidth control, stereo decoder, RDS decoder, and digital interfaces for external HD Radio™ decoding on a single IC.

AM/FM IBOC base band filtering is available in parallel to standard analog reception.

The utilization of digital signal processing results in numerous advantages: very low number of external components, very small space occupation and easy application, very high selectivity due to digital filters, high customization possibility through software control, automatic alignment and a powerful DSP for custom processing.

Two versions of the device cover different application/performance requirements:

TDA7786: entry-level, high-performance tuner;

TDA7786M: tuner with enhanced behavior in case of FM multipath, thanks to the proprietary MuSICA algorithm.

Both versions are HW- and SW-compatible.

Features



- AEC-Q100 qualified
- FM, AM and weather band reception
- Fully integrated VCO for world tuning
- High performance PLL for fast RDS system
- Integrated AM LNA and PIN diodes
- Automatic self alignment for FM front-end pre-selection filter and image rejection
- Integrated IF filters with high selectivity, dynamic range and adaptive bandwidth control
- Drift-free Digital-IF signal processing with high performance
- RDS demodulation with group and block synchronization
- High performance stereo decoder with noise-blanker
- Digital interface for HD Radio™ reception with digital audio blending
- I²C bus-controlled
- I²S input/output digital audio interfaces
- Single 5 V supply
- LQFP64 package
- MuSICA (multipath noise reduction) algorithm available for premium version of the device

Table 1. Device summary

Order code	Package	Packing
TDA7786	LQFP64 (10x10x1.4mm)	Tray
TDA7786M		

Contents

1	Block diagram and pin description	6
1.1	Block diagram	6
1.2	Pin description	7
2	Function description	12
2.1	FM - mixers	12
2.2	FM - AGC	12
2.3	AM - LNA	12
2.4	AM - AGC	12
2.5	AM - Mixers	12
2.6	IF A/D converters	13
2.7	Audio D/A converters	13
2.8	VCO	13
2.9	PLL	13
2.9.1	Tuner PLL	13
2.10	Crystal oscillator	13
2.11	DSP and digital hardware accelerators	14
2.12	Digital high speed IO interface pins	15
2.13	Multipath reduction	15
2.14	HD Radio™ connectivity	16
2.15	I ² S - serial audio interface	19
2.16	Audio sample rate converter	21
2.17	Serial control interface	22
2.17.1	Serial interface / boot mode	22
2.17.2	I ² C bus protocol	23
2.18	Digital-down-converter (DDC)	25
3	Electrical specifications	28
3.1	Absolute maximum ratings	28
3.2	Thermal data	28
3.3	General key parameters	28
3.4	Electrical characteristics	29
3.4.1	FM - section	29

3.4.2	AM - section	30
3.4.3	VCO	31
3.4.4	Phase locked loop	32
3.4.5	Tuning DAC	32
3.4.6	IF ADC	32
3.4.7	Audio DAC	33
3.4.8	IO interface pins	33
3.4.9	I ² C interface	34
3.5	Overall system performance	35
3.5.1	FM overall system performance	35
3.5.2	AM MW overall system performance	37
3.5.3	AM LW overall system performance	39
3.5.4	AM SW overall system performance	39
3.5.5	WX overall system performance	40
4	Front-end registers	41
5	Weak signal processing	45
5.1	FM IF-processing	45
5.1.1	Dynamic channel selection filter (DISS)	45
5.1.2	Soft mute	45
5.1.3	Adjacent channel mute	46
5.1.4	Stereo blend	46
5.1.5	High cut control	47
5.1.6	Stereo decoder	48
5.2	AM IF-processing	48
5.2.1	Channel selection filter	48
5.2.2	Soft mute	48
5.2.3	High cut control	49
6	Basic application schematic	50
7	Package information	51
7.1	LQFP64 (10x10x1.4 mm) package information	51
8	Revision history	53

List of tables

Table 1.	Device summary	1
Table 2.	Pin description	7
Table 3.	Suggested GPIO direction and driving capability	15
Table 4.	SAI_BB timing values (normal mode)	17
Table 5.	SAI_BB timing values (burst mode)	18
Table 6.	Audio I ² S configuration overview	19
Table 7.	I ² S interface timing (receiver)	20
Table 8.	I ² S interface timing (transmitter)	20
Table 9.	64-pin package boot mode configuration	22
Table 10.	Overall filter characteristics for IBOC_FM filter	25
Table 11.	Overall filter characteristics at output of IBOC_AM filter	26
Table 12.	Overall filter characteristics for FM (not including DISS filter)	27
Table 13.	Overall filter characteristics for AM	27
Table 14.	Absolute maximum ratings	28
Table 15.	Thermal data	28
Table 16.	General key parameters	28
Table 17.	FM - section	29
Table 18.	AM - section	30
Table 19.	VCO	31
Table 20.	Phase locked loop	32
Table 21.	Tuning DAC	32
Table 22.	IF ADC	32
Table 23.	Audio DAC	33
Table 24.	IO interface pins	33
Table 25.	I ² C interface	34
Table 26.	FM overall system performance	35
Table 27.	AM MW overall system performance	37
Table 28.	AM LW overall system performance	39
Table 29.	AM SW overall system performance	40
Table 30.	WX overall system performance	40
Table 31.	Register 0x00	41
Table 32.	Register 0x01	42
Table 33.	Register 0x02	43
Table 34.	Register 0x05	44
Table 35.	Register 0x08	44
Table 36.	Dynamic channel selection filter (DISS) - discrete set	45
Table 37.	Soft mute - continuous set	45
Table 38.	Adjacent channel mute - continuous set	46
Table 39.	Stereo blend - continuous set	46
Table 40.	High cut control - continuous set	47
Table 41.	De-emphasis filter - continuous set	48
Table 42.	Stereo decoder - continuous set	48
Table 43.	Channel selection filter	48
Table 44.	Soft mute - continuous set	48
Table 45.	High cut control - continuous set	49
Table 46.	LQFP64 (10x10x1.4 mm) package mechanical data	52
Table 47.	Document revision history	53

List of figures

Figure 1.	Functional block diagram	6
Figure 2.	Pin connection (top view)	7
Figure 3.	Crystal oscillator block diagram	14
Figure 4.	HD Radio™ system architecture example	16
Figure 5.	SAI_BB waveforms (normal mode)	17
Figure 6.	SAI_BB waveforms (burst mode)	18
Figure 7.	I ² S interface timing (receiver)	19
Figure 8.	I ² S interface timing (transmitter)	20
Figure 9.	I ² S interface 16-bit	21
Figure 10.	I ² S interface 32/24/20/16-bit	21
Figure 11.	I ² C "write" sequence	23
Figure 12.	I ² C "read" sequence	23
Figure 13.	Digital-down-converter simplified block diagram	25
Figure 14.	Cumulative transfer function at output of IBOC_FM filter	25
Figure 15.	Cumulative transfer function at output of IBOC_AM filter	26
Figure 16.	Cumulative digital-down-converter transfer function for FM	26
Figure 17.	Cumulative digital-down-converter transfer function for AM	27
Figure 18.	I ² C bus timing diagram	34
Figure 19.	FM input set-up	35
Figure 20.	AM MW input set-up	37
Figure 21.	AM LW input set-up	39
Figure 22.	AM SW input set-up	39
Figure 23.	WX input set-up	40
Figure 24.	FM wide-band application	50
Figure 25.	LQFP64 (10x10x1.4 mm) package outline	51



1 Block diagram and pin description

1.1 Block diagram

Figure 1. Functional block diagram

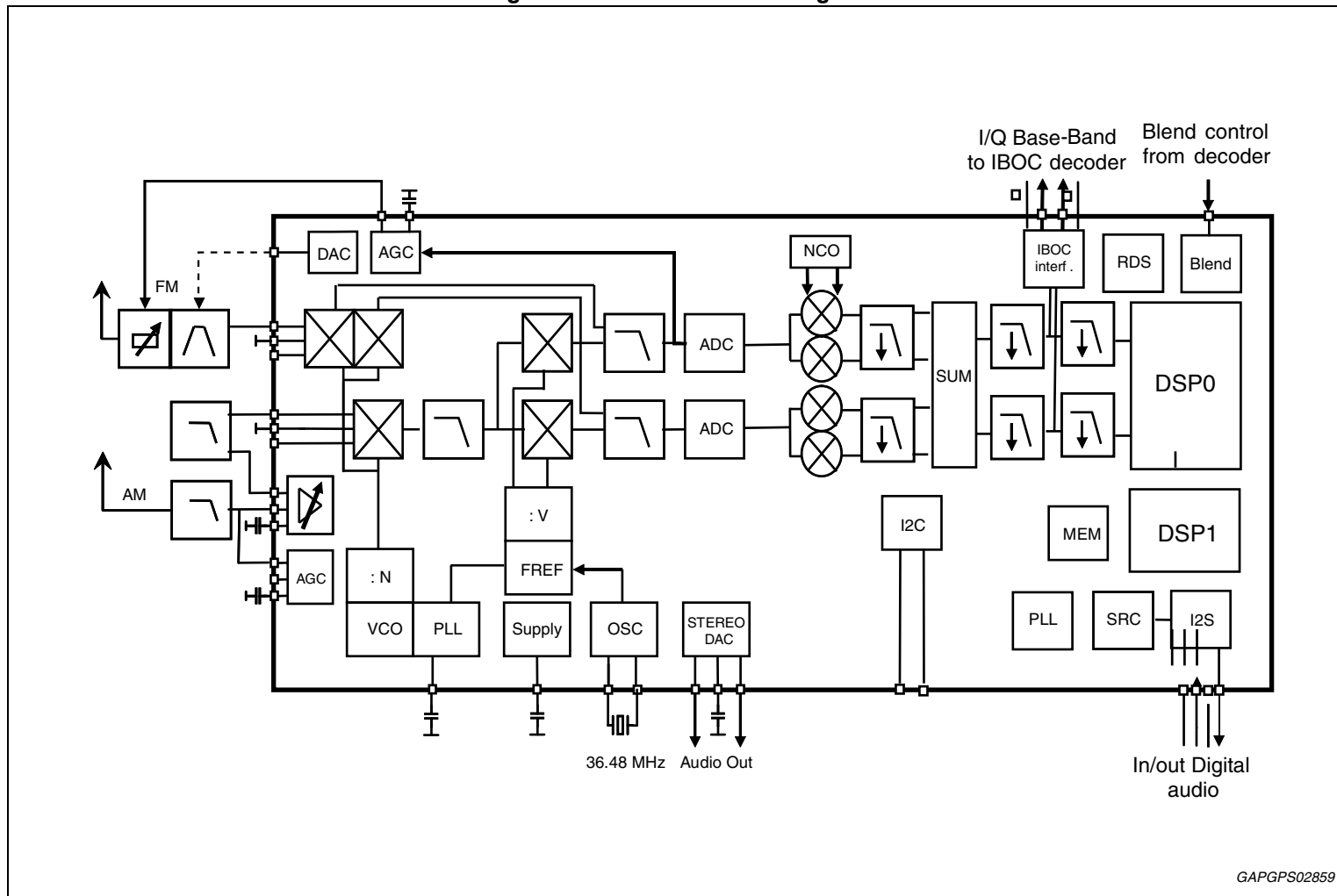

GAPGPS02859

1.2 Pin description

Figure 2. Pin connection (top view)

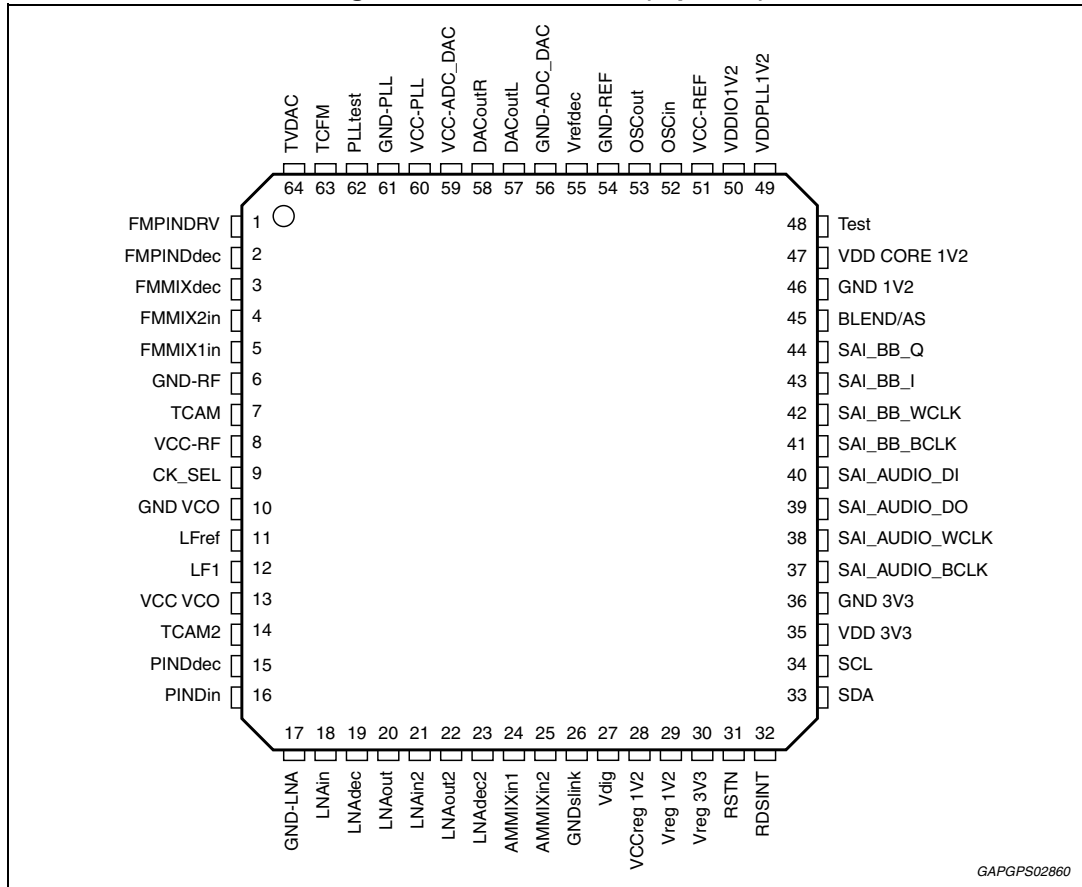

GAPGPS02860

Table 2. Pin description

Pin	Pin name	I/O	Function	Description	Equivalent circuit
1	FMPINDRV	Out	FM	FM PIN diode driver output	
2	FMPINDdec	In		Integrated FM PINdiode decoupling	
3	FMMIXdec	-		FM RF signal ground	
4	FMMIXin2	In		FM mixer input 2	
5	FMMIXin1	In		FM mixer input 1	
6	GNDRF	-	-	RF power ground	-

Table 2. Pin description (continued)

Pin	Pin name	I/O	Function	Description	Equivalent circuit
7	TCAM	-	-	AM AGC time constant	
8	VCCRF	In	-	RF 5 V supply	-
9	CK_SEL	In	-	Master/Slave clock operation select	
10	GNDVCO	-	VCO	VCO ground	-
11	LFref	-		Loop filter reference	-
12	LF1	-		Loop filter output	-
13	VCCVCO	In		VCO 5V supply	-
14	TCAM2	-	-	AM AGC 2 nd order time constant	
15	PINDdec	-	AM pin diode	AM AGC internal PIN diode decoupling	
16	PINDin	-		AM AGC internal PIN diode input	
17	GNDLNA	-	AM LNA	AM LNA ground	-
18	LNAin	In		AM LNA input	
19	LNAdec	-		AM LNA decoupling	
20	LNAout	Out		AM LNA output	-
21	LNAin2	-		AM LNA input 2 nd stage	-

Table 2. Pin description (continued)

Pin	Pin name	I/O	Function	Description	Equivalent circuit
22	LNAout2	-	AM LNA	AM LNA output 2 nd stage	
23	LNAdec2	-		AM LNA decoupling 2 nd stage	
24	AMMIXin1	In	AM mixer inputs	AM mixer input 1	
25	AMMIXin2	In		AM mixer input 2	
26	GNDLINK	-	Supply, ground and reset	Internal inter-IC communication bus ground	-
27	Vdig	In		Front-end digital 5 V supply	-
28	VCCreg1V2	In		Internal 1.2 V regulator 5 V supply	-
29	REG1V2	Out		Internal 1.2 V regulator output	
30	Vreg3v3	Out		Internal 3.3 V regulator output	
31	RSTN	In		Reset (low active) Pull-up 50 kΩ to 3.3 V IO supply	
32	RDSINT	Out		RDS interrupt output Pull-down 50 kΩ to ground	-
33	SDA	In/Out	I ² C interface	I ² C bus data Pull-up 50 kΩ to 3.3 V IO supply	
34	SCL	In		I ² C bus clock Pull-up 50 kΩ to 3.3 V IO supply	
35	VDD3V3	In	-	IO ring (3.3 V) supply	-
36	GND3V3	-	-	IO ring (3.3 V) supply	-

Table 2. Pin description (continued)

Pin	Pin name	I/O	Function	Description	Equivalent circuit
37	SAI_AUDIO_BCLK	In/Out	HD Radio™ connectivity/ Audio output I2S interface	SAI clk Pull-down 50 kΩ to ground, SINE_3V3_LIN pad	
38	SAI_AUDIO_WCLK	In/Out		Audio SAI word-select Pull-down 50 kΩ to ground, SINE_3V3_LIN pad	
39	SAI_AUDIO_DO	Out		Audio SAI data output Pull-down 50 kΩ to ground, SINE_3V3_LIN pad	
40	SAI_AUDIO_DO	In		Audio SAI data-input Pull-down 50 kΩ to ground, SINE_3V3_LIN pad	
41	SAI_BB_BCLK	In/Out		SAI Base-Band clock Pull-down 50 kΩ to ground, SINE_3V3_LIN pad	
42	SA_BB_WCLK	In/Out		SAI Base-Band word-select Pull-down 50 kΩ to ground, SINE_3V3_LIN pad	
43	SAI_BB_I	Out		SAI Base-Band I data Pull-down 50 kΩ to ground, SINE_3V3_LIN pad	
44	SAI_BB_Q	Out		SAI Base-Band Q data Pull-down 50 kΩ to ground, SINE_3V3_LIN pad	
45	BLEND/AS	In		HD blend input Pull-down 50 kΩ to ground	
46	GND1V2	-	-	DSP core ground	-
47	VDD core 1V2	In	-	DSP core 1.2 V supply	-
48	Test	In	-	Test Mode Pull-down 50 kΩ to ground	
49	VDDPLL1V2	In	-	Digital PLL 1.2 V supply	-
50	VDDIO1V2	In	-	Internal inter-IC communication 1.2 V supply	-
51	VCC-REF	In	-	Front-end reference frequency and regulator 5 V supply	-

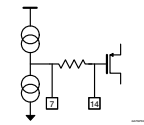
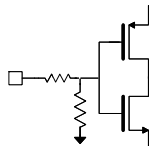
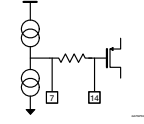
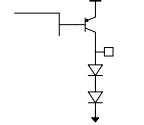
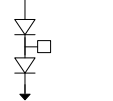
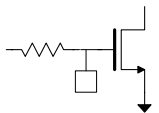
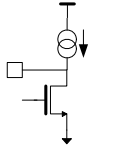
Table 2. Pin description (continued)

Pin	Pin name	I/O	Function	Description	Equivalent circuit
52	OSCin	In	Oscillator	Crystal oscillator input	-
53	OSCut	Out		Crystal oscillator output	
54	GND-REF	-	-	Front-end reference frequency and regulator ground	-
55	Vrefdec	-	-	3.3 V Bias generation decoupling	
56	GND-ADC_DAC	-	DAC	IFADC and audio DAC ground	-
57	DACoutL	Out		Audio output left	
58	DACoutR	Out		Audio output right	
59	VCC-ADC_DAC	In	-	IFADC and audio DAC 5 V supply	-
60	VCC-PLL	In	PLL	Tuning PLL 5 V supply	-
61	GND-PLL	-		Tuning PLL ground	-
62	PLLtest	Out		PLL Test output	
63	TCFM	-	-	FM AGC time constant	
64	TVDAC	Out	-	Tuning voltage output	-

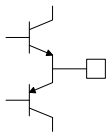
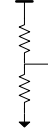
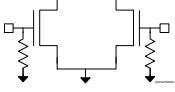
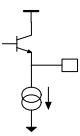
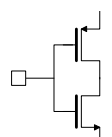
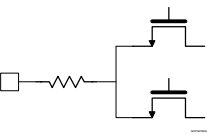
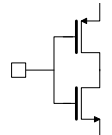
2 Function description

2.1 FM - mixers

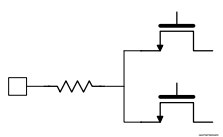
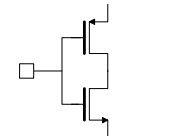
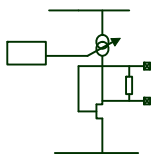
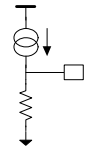
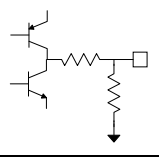
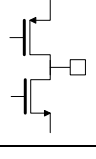
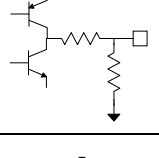
The FM Image Rejection mixer has two single ended inputs, selectable through software. They are designed to achieve best performance both in case of a passive tuned preselection and of a passive fixed band-pass preselection without tuning for lower cost applications.

The input frequency is down-converted to very low IF with high image rejection.

The tuned application is supported by an 8-bit tuning DAC. The alignment of the DAC is performed automatically on-chip.

2.2 FM - AGC

The programmable RFAGC senses the mixer input to avoid overload.

When the RFAGC threshold is reached, the PIN diode output is activated in order to attenuate the incoming RF signal

The PIN diode driver is able to drive external PIN diodes with up to 15 mA current.

The time constant of the FM AGC is defined by the combination of an external capacitor and internal currents. There are two programmable attack and decay time constants.

2.3 AM - LNA

The integrated AM LNA feature is integrated with low-noise and high IIP2 and IIP3. The gain of the LNA is controlled by the AGC. The maximum gain is set with an external resistor, typically 26 dB with 470 Ω .

2.4 AM - AGC

The programmable AM RFAGC senses the mixer inputs and controls the internal PIN diodes and LNA gains.

Firstly the LNA gain is reduced by about 10 dB, and then the PIN diodes are activated to further attenuate the signal.

The time constant of the 2nd order AM AGC LPF is defined by both external components and programmable internal currents.

2.5 AM - Mixers

The image rejection mixer has two AM inputs selectable via software. It easily supports low-cost applications for extended frequency bands like short-waves.

The input frequency is converted to low IF with high image rejection.

2.6 IF A/D converters

A high performance IQ-IFADC converts the IF signal to the digital domain for subsequent digital signal processing.

Two fully differential, continuous-time Sigma-Delta ($\Sigma\Delta$) IF-ADCs are used for both the 'I' path and the 'Q' path. For each IFADC, two fully differential input nodes are fed with an input signal having a bandwidth up to 325 kHz. This fully differential design provides good suppression of even-order harmonics. For complex filtering, the input signals of the 'I' path and the 'Q' path have a 90 degree phase shift. The IFADC sampling frequency is 36.48 MHz.

2.7 Audio D/A converters

A CD-quality (>100dB DR) stereo DAC provides the left/right audio signals after IF processing and stereo-decoding by the DSP. In presence of an external HD Radio™ decoder the DAC delivers the high quality audio resulting from the decoding of the HD Radio™ transmissions.

2.8 VCO

The VCO is fully integrated without any external tuning component. It covers all the FM frequency bands including EU, US, Japan, East-Europe, Weather-Band and the AM bands including LW, MW and SW. Its center frequency is approximately 2.7 GHz.

2.9 PLL

2.9.1 Tuner PLL

The very high-speed tuning PLL is able to settle within about 100 μ s for fast RDS applications. The frequency step can be as low as 5 kHz in FM and 500 Hz in AM.

2.10 Crystal oscillator

The device works with a 36.48 MHz fundamental tone crystal. The oscillator block diagram is shown in [Figure 3](#). On the PCB the crystal must be connected as close as possible to the chip oscillator input and output pins of the chip. The internal load capacitance together with pin and pad capacitance is optimized for fundamental tone crystal units at 36.48 MHz. It is not recommended to put any additional external load capacitors. By suitably configuring pin #9 (CK_SEL), the device can be operated as either a clock master or a clock slave. If pin 9 is left open or tied to GND, the device is configured as clock master (typical operation mode). In case the device is configured as clock slave, pin 9 needs to be connected to 5 V. Then the crystal oscillator is switched off and the device expects a crystal equivalent signal on the OSCout/OSCin pins.

Figure 3. Crystal oscillator block diagram

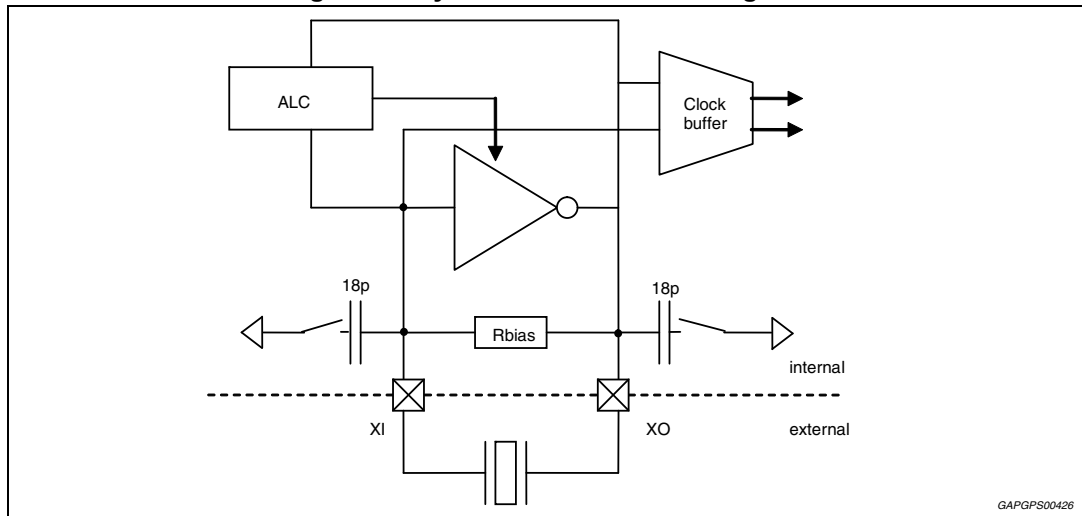

2.11 DSP and digital hardware accelerators

The TDA7786x embeds two DSP cores for high computational power and achievable customization. The DSP cores, in combination with the hardware accelerators, take care of all the tuner digital signal processing. The main program is fixed in ROM. Control parameters are copied to RAM and are accessible and modifiable there, thus allowing a parametric performance optimization. The operations performed by the DSP cores and HW accelerators are:

- digital down-conversion of IF
- bandwidth selection with variable controlled bandwidth
- FM and AM noise blanking
- FM/AM demodulation with soft-mute, high-cut, weak signal processing and quality detection
- FM stereo decoding with stereo-blend
- RDS demodulation including error correction and block synchronization with generation of an RDS interrupt for the main μ P
- Autonomous control of RDS-AF tests
- Self-alignment of pre-selection tuning

2.12 Digital high speed IO interface pins

The IC has several IOs tasked for connectivity to an external HD Radio™ decoder and/or to I²S audio sources and destinations (pins 37 to 44).

These pins are driven by a special buffer that has been developed to reduce disturbance originating from activity on the digital lines. This bidirectional buffer is based on a TTL Schmitt trigger receiver and a slew-rate controlled driver with programmable cut-off frequency and current capability.

Typical configurations of these IOs for both analog and digital-HD reception are indicated in [Table 3](#); for the suggested configuration all the slew-rate controlled pads are programmed with a 10 MHz cut-off frequency:

Table 3. Suggested GPIO direction and driving capability

Pin	Use case: HD reception	Use case: digital audio out	Driving capability	
			10 pF	5 pF
37	IN	OUT		X
38	IN	OUT		X
39	OUT	OUT		X
40	IN	IN		X
41	OUT	-	X	
42	OUT	-		X
43	OUT	-	X	
44	OUT	-	X	

In case a different GPIO configuration is used, it is recommended to connect the TDA7786x to an externally regulated 3.3 V source.

2.13 Multipath reduction

The TDA7786 is equipped with a basic FM multipath noise reduction system in addition to the traditional weak signal processing. The algorithm, called DANCE, assures an improved performance in presence of in-band interference (such as in case of multipath).

The premium version of the ELITE family, the TDA7786M is equipped with a superior algorithm, called MuSICA, to further enhance the reception quality even in presence of strong multipath.

2.14 HD Radio™ connectivity

The ELITE complies with HD Radio™ interface specifications as per Ibiqity's 'RX_SSS_1108 HD Radio™ power efficient RF-IF and peripheral processing (power RIPP) specification', thus providing an external HD Radio™ decoder with I/Q base-band signals and receiving the decoded digital audio from it, as shown in [Figure 4](#).

Figure 4. HD Radio™ system architecture example

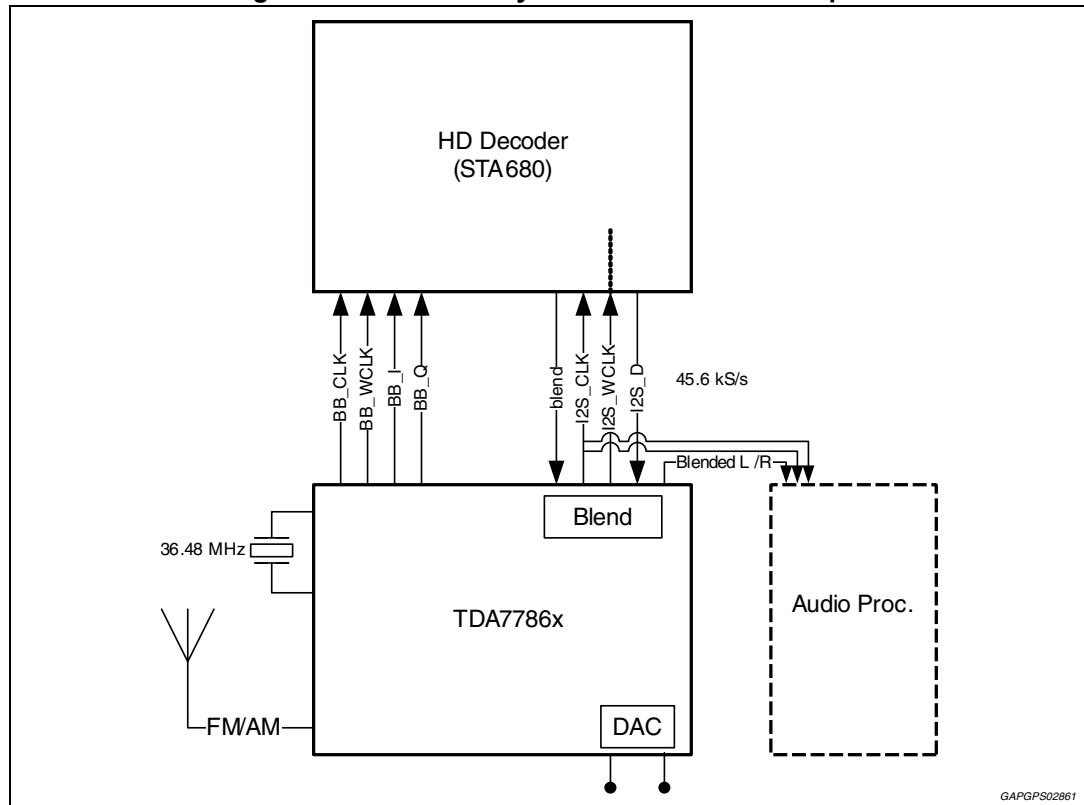

The complex baseband signal of an IBOC transmission is sent to the external decoder using the dedicated digital output interface SAI_BB. The SAI_BB supports the modes shown in both [Figure 5](#) and [Figure 6](#). Timing information for the protocols shown is detailed in [Table 4](#) and [Table 5](#).

Figure 5. SAI_BB waveforms (normal mode)

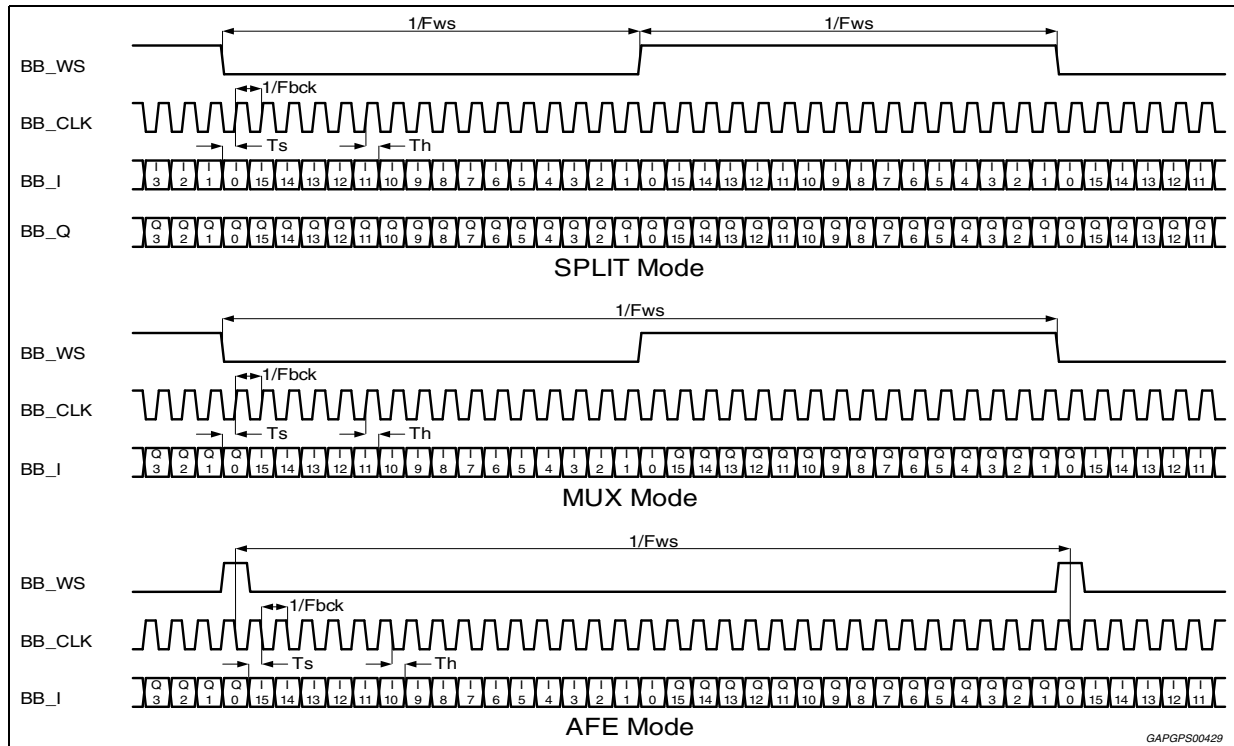

Table 4. SAI_BB timing values (normal mode)

Symbol	Parameter	Rate					Unit
Fpll	PLL clock	332.8	345.6	451.584	466.944	245.76	MHz
Fws	Word strobe	650 (332.8/512)	675 (345.6/512)	882 (451.582/512)	912 (466.944/512)	48 (245.76/5120)	KHz
Fbclk	Bit clock in SPLIT mode	10.4 (332.8/32)	10.8 (345.6/32)	14.112 (451.584/32)	14.592 (466.944/32)	0.768 (245.76/320)	MHz
Fbclk	Bit clock in MUX mode	20.8 (332.8/16)	21.6 (345.6/16)	28.224 (451.584/16)	29.184 (466.944/16)	1.536 (245.76/160)	MHz
Fbclk	Bit clock in AFE mode	20.8 (332.8/16)	21.6 (345.6/16)	28.224 (451.584/16)	29.184 (466.944/16)	1.536 (245.76/160)	MHz
Ts	Data setup time (min)	5	5	5	5	5	ns
Th	Data hold time (min)	5	5	5	5	5	ns

Figure 6. SAI_BB waveforms (burst mode)

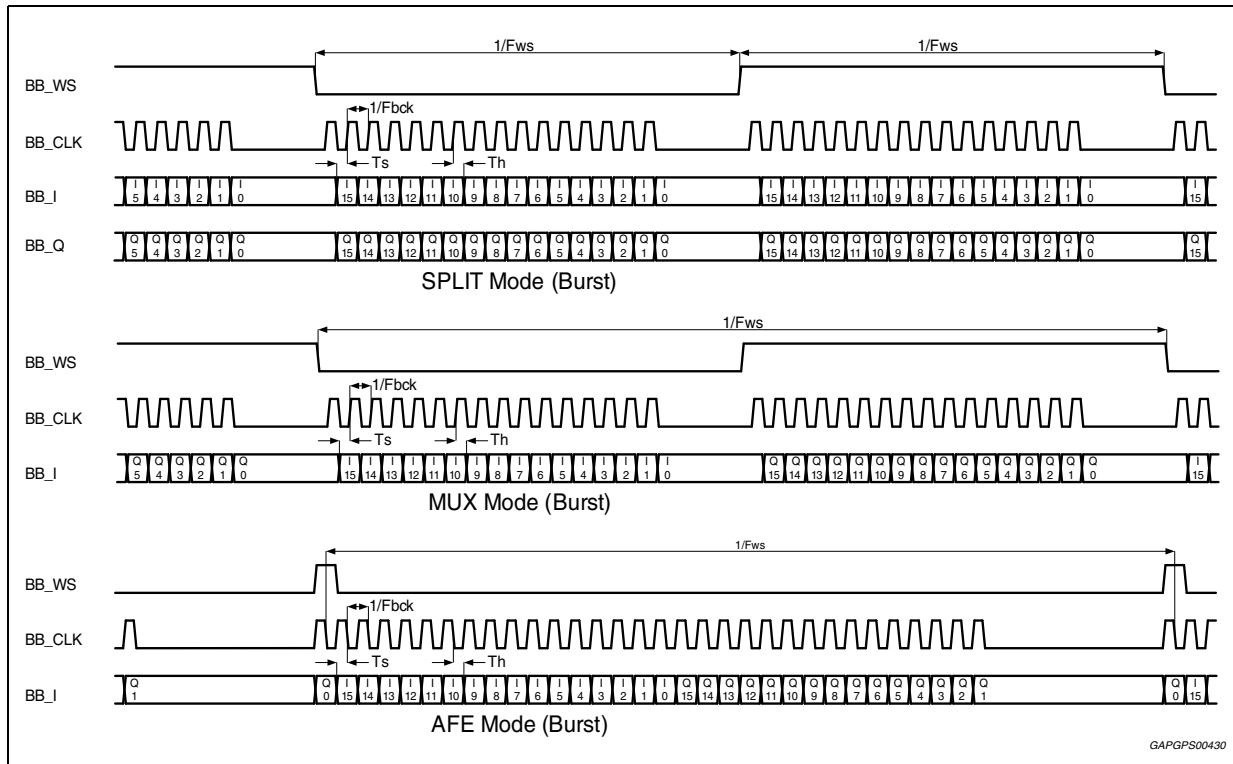

Table 5. SAI_BB timing values (burst mode)

Symbol	Parameter	Rate					Unit
Fpll	PLL clock	332.8	345.6	451.584	466.944	245.76	MHz
Fws	Word strobe	650 (332.8/512)	675 (345.6/512)	882 (451.582/512)	912 (466.944/512)	48 (245.76/5120)	KHz
Fbclk	Bit clock in SPLIT mode	$332.8/n$ ($n=16/32$)	$345.6/n$ ($n=16/32$)	$451.584/n$ ($n=16/32$)	$466.944/n$ ($n=16/32$)	$245.76/n$ ($n=160/320$)	MHz
Fbclk	Bit clock in MUX mode	$332.8/n$ ($n=8/16$)	$345.6/n$ ($n=8/16$)	$451.584/n$ ($n=8/16$)	$466.944/n$ ($n=8/16$)	$245.76/n$ ($n=80/160$)	MHz
Fbclk	Bit clock in AFE mode	$332.8/n$ ($n=8/16$)	$345.6/n$ ($n=8/16$)	$451.584/n$ ($n=8/16$)	$466.944/n$ ($n=8/16$)	$245.76/n$ ($n=80/160$)	MHz
T_s	Data setup time (min)	5	5	5	5	5	ns
T_h	Data hold time (min)	5	5	5	5	5	ns

2.15 I²S - serial audio interface

The audio SAI serves as stereo input/output audio bus interface (e.g. to an external audio processor, or from an external HD decoder) using the I²S protocol. The latter calls for a bit clock line, a word select line and data lines; the SAI interface on the TDA7786x has one input data line and one output data line.

The audio SAI lines are: SAI_AUDIO_CLK (pin 37, bit clock line), SAI_AUDIO_WCLK (pin 38, word select (frame) clock line), SAI_AUDIO_DO (pin 39, data output line), SAI_AUDIO_DI (pin 40, data input line). In master mode SAI_AUDIO_BCLK and SAI_AUDIO_WCLK are outputs, in slave mode these pins are inputs.

The input and output data lines are operated at the same sampling frequency.

The bit clock has one pulse for each discrete bit of data on the data lines. The bit clock operates at a frequency which is a multiple of the sample rate, and is equal to the sampling frequency times the number of bits per word times two.

Table 6. Audio I²S configuration overview

Name	Channels	Word length	Valid Bits	Pins	Formats	Master/Slave mode	Input Rate /ksps	Output Rate /ksps	Max. bit clock frequency
SAI	1x2 In and 1x2 Out	16/32	16/24	4	I ² S	M/S	32-48	32-48	12.288 MHz

Figure 7. I²S interface timing (receiver)

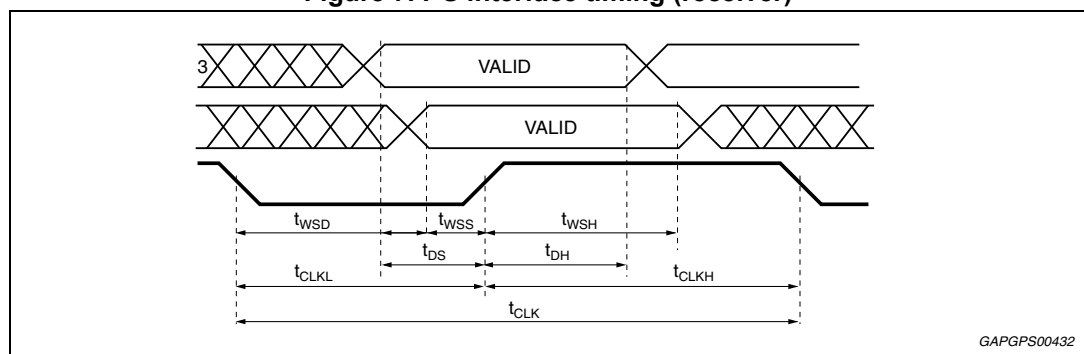

Note: The polarity of the signals and the data bit-shift direction can be selected by configuration bits.

Table 7. I²S interface timing (receiver)

Symbol	Parameter	Condition	Min.	Typ.	Max.	Unit
t _{CLK}	Minimum Clock Cycle (CLK)	-	50	-	-	ns
t _{CLKH}	Minimum bit clock high time	-	25	-	-	ns
t _{CLKL}	Minimum bit clock low time	-	25	-	-	ns
t _{WSS}	Word-select setup time	slave mode	5	-	-	ns
t _{WSH}	Word-select hold time	slave mode	3	-	-	ns
t _{WSD}	Word-select delay	master mode	4	-	-	ns
t _{DS}	Data setup time	-	5	-	-	ns
t _{DH}	Data_hold time	-	5	-	-	ns

Figure 8. I²S interface timing (transmitter)

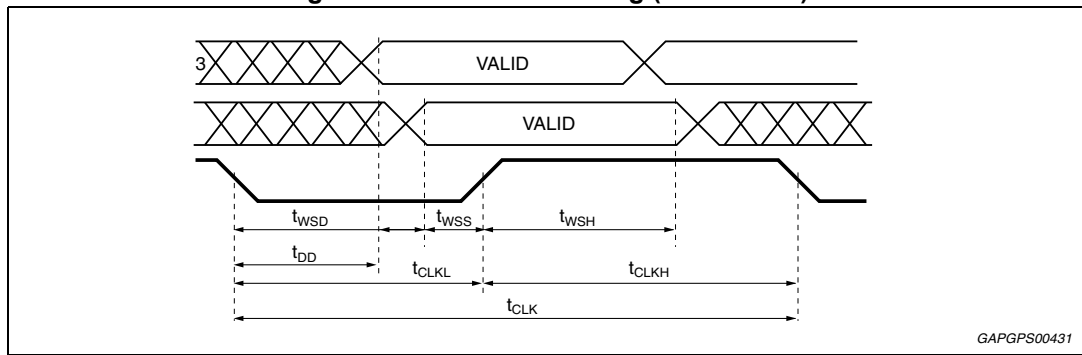

Note: The polarity of the signals and the data shift direction can be selected by configuration bits.

Table 8. I²S interface timing (transmitter)

Symbol	Parameter	Condition	Min.	Typ.	Max.	Unit
t _{CLK}	Minimum Clock Cycle (CLK)	-	50	-	-	ns
t _{CLKH}	Minimum bit clock high time	-	25	-	-	ns
t _{CLKL}	Minimum bit clock low time	-	25	-	-	ns
t _{WSS}	Word-select setup time	slave mode	5	-	-	ns
t _{WSH}	Word-select hold time	slave mode	5	-	-	ns
t _{WSD}	Word-select delay	master mode	5	-	-	ns
t _{DD}	Data delay	-	5	-	-	ns

The audio SAI can be configured via software to be operating either in master or in slave mode. The frame length is selectable as 16/32 bits per word, with 16/24 valid bits. [Figure 9](#) shows the default setting of SAI for the 16-bit mode. Different settings of clock polarity, word clock polarity, transmission mode (I²S mode) and data direction (either MSB or LSB first transmission) are possible, and they can be changed through software. Supported configurations are shown in [Figure 10](#). Timing information for the protocols is detailed in [Figure 10](#).

Figure 9. I²S interface 16-bit

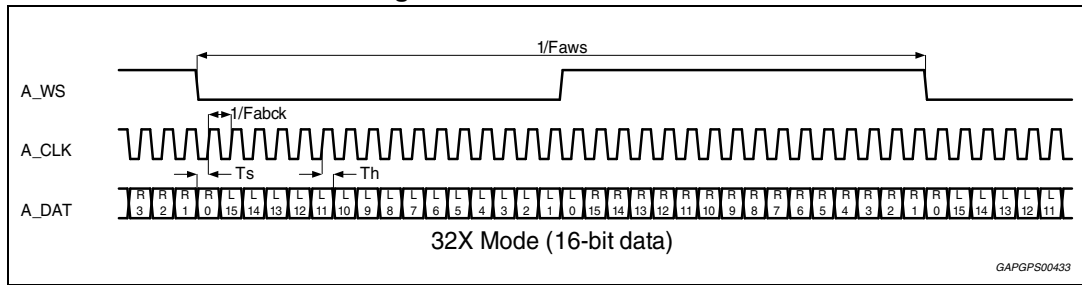
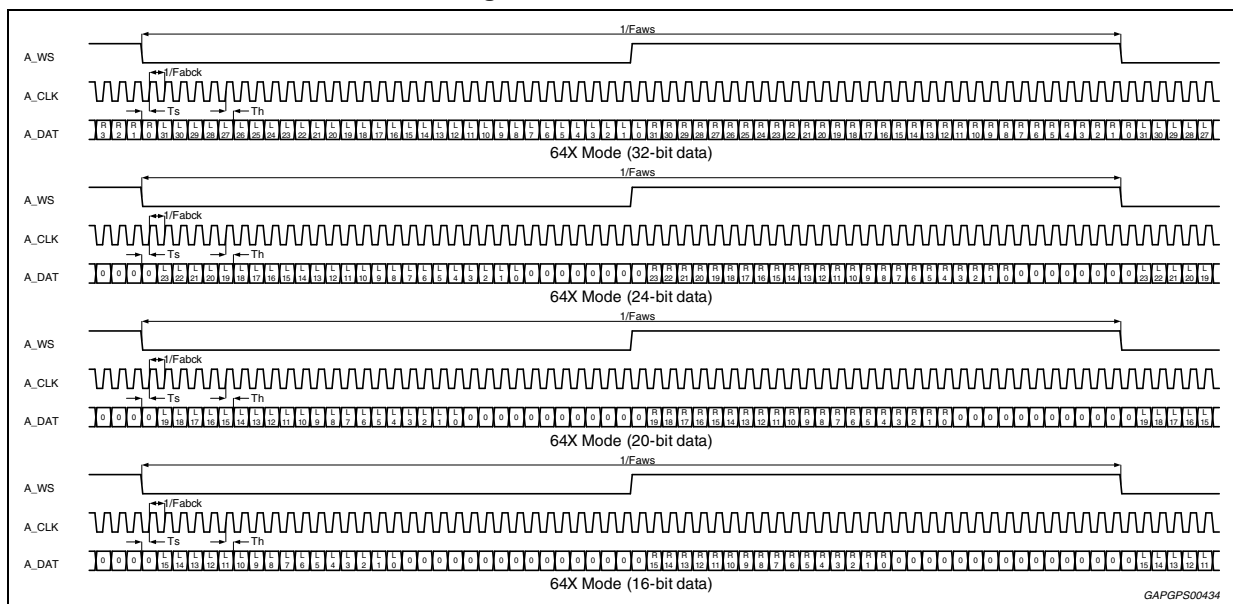

Figure 10. I²S interface 32/24/20/16-bit



2.16 Audio sample rate converter

The TDA7786x is equipped with internal sample rate converters (SRC) that can be configured to modify the sampling frequency of outgoing and incoming digital audio both in the master and in the slave SAI mode (the native audio sampling frequency of the TDA7786x is 45.6 kHz).

The SRC is able to automatically detect the input and output sampling rates and includes a sample clock jitter rejection function which can be enabled separately. The input signal word-width is 20 bits, while the output signal word width can be selected as 20 bits or 16 bits. In order to properly assist in the conversion, the SRC is coupled to self-adjusting low-pass filters.

2.17 Serial control interface

The device is controlled via I²C.

Through serial bus the processing parameters can be modified and the signal quality parameters and the RDS information can be read out.

The operation of the device is handled mainly through high level commands sent by the car-radio microprocessor through the serial interface, which allows simplification of the operations carried out in the microprocessor itself. The high level commands include among others:

- change frequency (which allows to avoid computing the PLL divider factors)
- change band;
- start seek (the seek operation can be carried out by the TDA7786x in a completely autonomous fashion);
- RDS seek/search (jumps to AF and quality measurements are automatically sequenced).

2.17.1 Serial interface / boot mode

The device possesses two different I2C addresses: 0xC2/C3 and 0xC8/C9. The configuration is chosen by applying the proper voltage at the exit from reset to the pins indicated in [Table 9](#). The configuration is latched (e.g. made effective) when the RSTN line transitions from low to high (when RSTN is low, the IC is in reset mode).

The voltage level forced to the boot pins must be released to start the system operation a suitable time after the RSTN line has gone high. The list of configurations is shown in the following table:

Table 9. 64-pin package boot mode configuration

SAI_AUDIO_DO pin 39	RDS INT pin 32	BUS mode
0	0	I ² C Address = 0xC2
0	1	I ² C Address = 0xC8

The status of these pins during the reset phase can be set to:

- High: through external <10 kΩ resistors tied to 3.3V
- Low: by not forcing any voltage on them from outside, as 50 kΩ internal pull-down resistors are present inside the device.

To make sure the I²C address is correctly latched up at start-up, it is advisable to keep the RSTN line low until the IC supply pins have reached their steady state, and further keep it low for an additional time Treset.

2.17.2 I²C bus protocol

The I²C communication requires two signals: clock (SCL) and data (SDA - bidirectional). The protocol requires an acknowledge signal after any 8-bit transmission.

A "write" communication example is shown in the figure below, for an unspecified number of data bytes (see the relevant technical documentation for frame structure description):

Figure 11. I²C "write" sequence

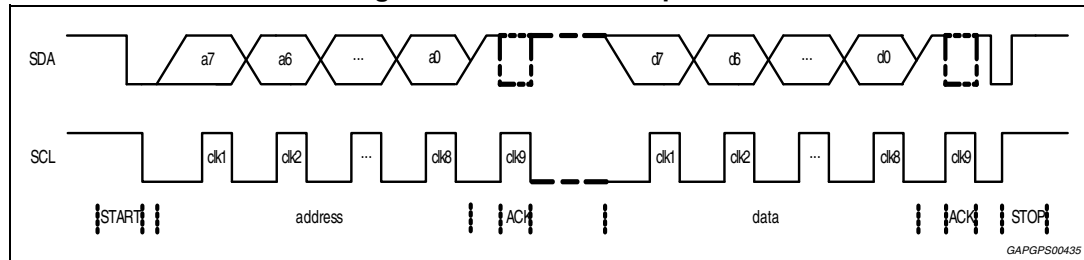

The sequence consists of the following phases:

1. **START:** SDA line transitioning from H to L with SCL fixed H. This indicates that a new transmission is starting;
2. **DATA LATCHING:** on the rising SCL edge. The SDA line can vary only when SCL is low (otherwise its transitions are interpreted as either a START or a STOP transition);
3. **ACKNOWLEDGE:** on the 9th SCL pulse the microprocessor keeps the SDA line H, and the TDA7786x pulls it down in case the communication has been successful. Lack of the acknowledge pulse generation from the TDA7786x indicates a communication failure; the chip-address byte must be sent at the beginning of the transmission. The value can be 0xC2 or 0xC8 (according to the mode chosen at start-up) for "write"; as many data bytes as needed can follow the address before the communication is terminated. See the next section for details on the frame format;
4. **STOP:** SDA line transitioning from L to H with SCL H. This signifies the end of the transmission.

Dashed lines represent transmissions from the TDA7786x to the microprocessor. A communication example is shown in the figure below, for an unspecified number of data bytes (see later on for frame structure description):

Figure 12. I²C "read" sequence

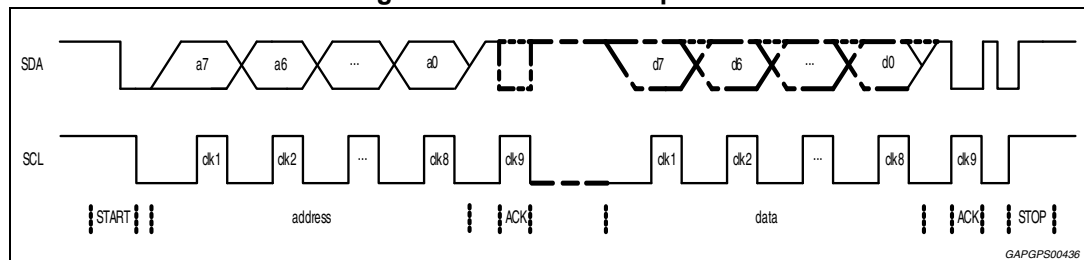

The "read" sequence is similar to the "write" and it has the same constraints for start, stop, data-latching and the following differences:

- the chip address must always be sent by the microprocessor to the TDA7786x; the address must be 0xC3 (if C2 had been selected at boot) or 0xC9 (if 0xC8 had been selected at boot);
- the header is transmitted after the chip address (the same happens for "write") before data are transferred from the TDA7786x to the microprocessor. See the relevant technical documentation for details on the frame format;
- when data are transmitted from the TDA7786x to the μ P, the latter keeps the SDA line H;
- the acknowledge pulse is generated by the μ P for those data bytes that are sent by the TDA7786x to the μ P. Failure of the μ P to generate an ACK pulse on the 9th CLK pulse has the same effect on the TDA7786x as a STOP.

The maximum clock speed is 500 kbit/s.

Warning: When the TDA7786x is not powered on, the internal ESD protection diodes act as a pull-down keeping the I²C lines voltage below 2 V. This implies that the I²C bus connected to the TDA7786x may not be used to drive other devices when the TDA7786x is powered off.

2.18 Digital-down-converter (DDC)

The complex digital mixer in the DDC performs mixing of the IF signal to zero IF. The internal sample rate for FM/AM processing is 456 kS/s and the sample rate for FM/AM IBOC is 912 kS/s. AM IBOC require additional filtering implemented in software.

Figure 13. Digital-down-converter simplified block diagram

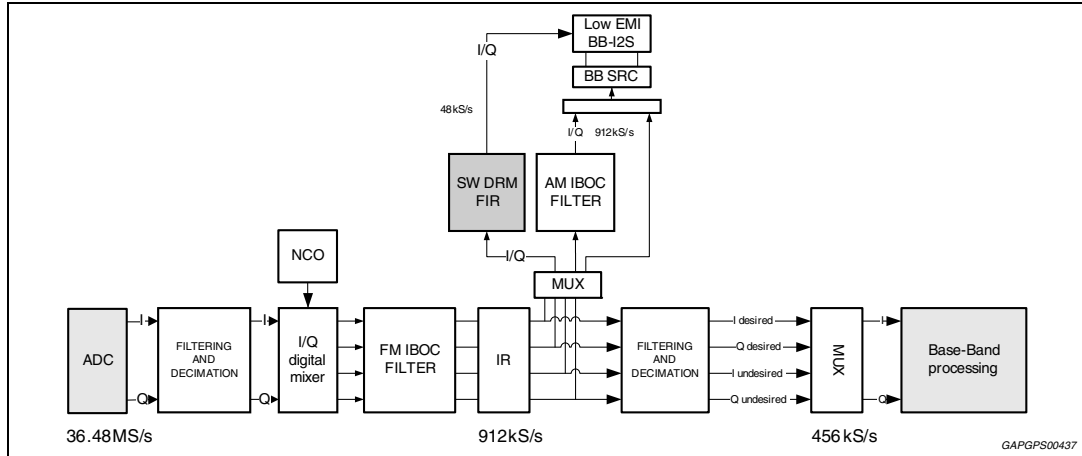

Figure 14. Cumulative transfer function at output of IBOC_FM filter

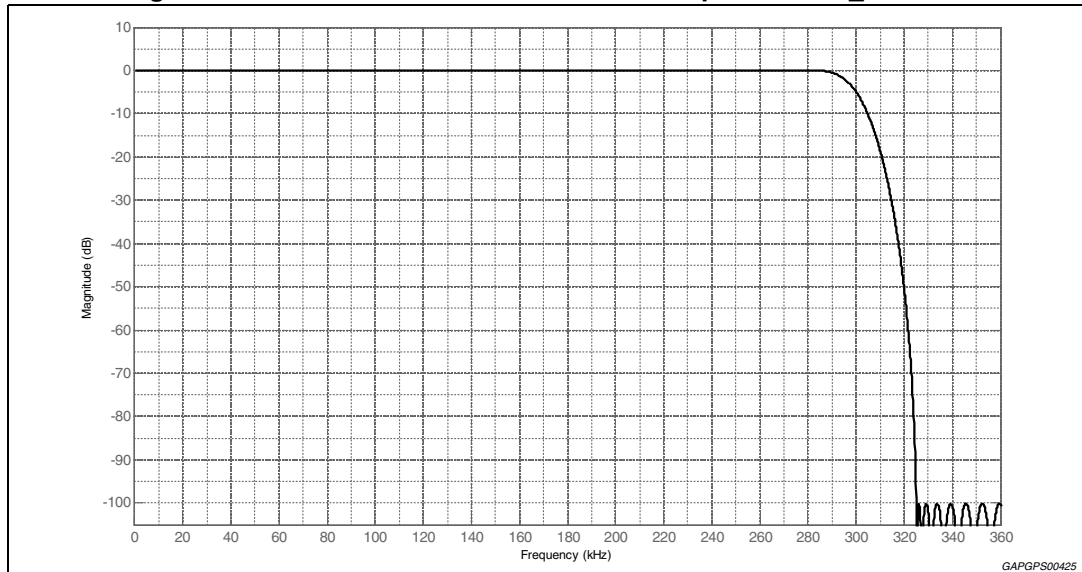

Table 10. Overall filter characteristics for IBOC_FM filter

Item	Value	Unit
Pass-band edge	282	kHz
Stop-band edge	325	kHz
In-band ripple (0 kHz to 282 kHz)	<0.002	dB
Anti-alias band range	[-500 +500]	kHz
Anti-alias Attenuation	100	dB

Figure 15. Cumulative transfer function at output of IBOC_AM filter

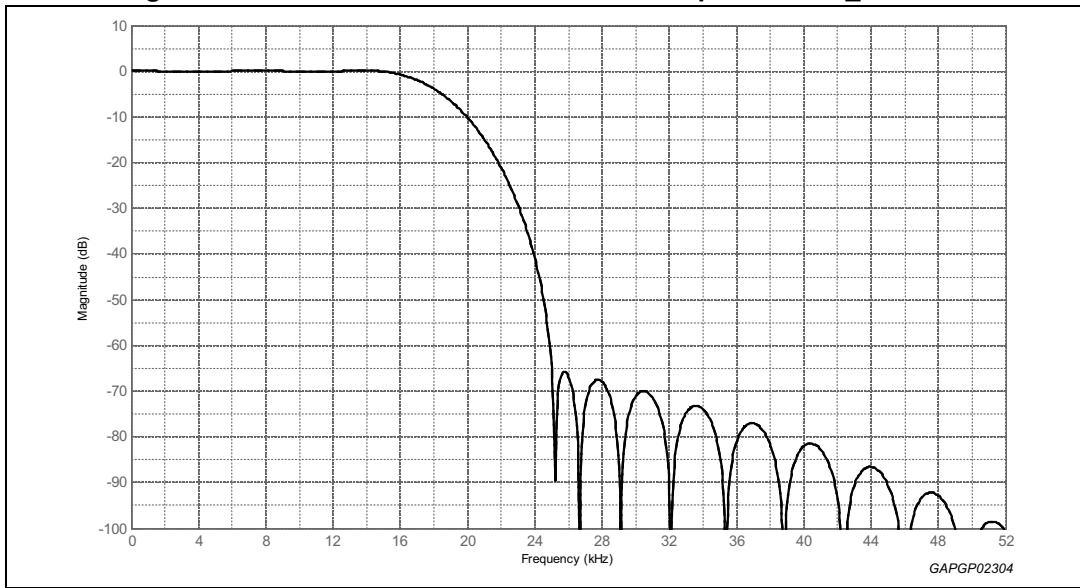

Table 11. Overall filter characteristics at output of IBOC_AM filter

Item	Value	Unit
Pass-band edge	15	kHz
Stop-band edge	25	kHz
In-band ripple	<0.34	dB
Anti-alias Attenuation	>100	dB

Figure 16. Cumulative digital-down-converter transfer function for FM

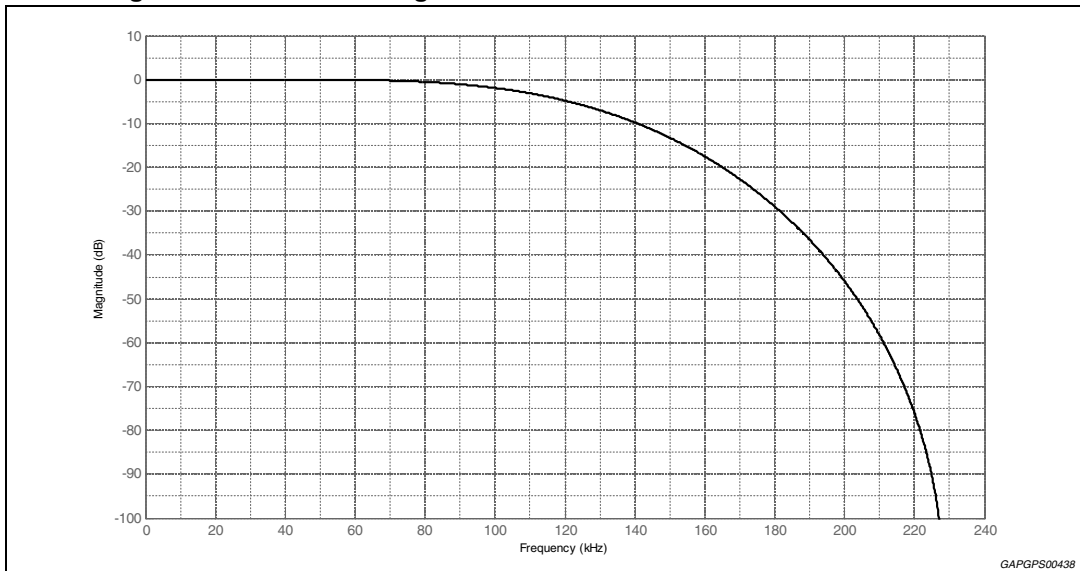

Table 12. Overall filter characteristics for FM (not including DISS filter)

Item	Value	Unit
Pass-band edge	45.8	kHz
Stop-band edge	228	kHz
In-band ripple	<0.003	dB
Anti-alias Attenuation	>100	dB

Figure 17. Cumulative digital-down-converter transfer function for AM

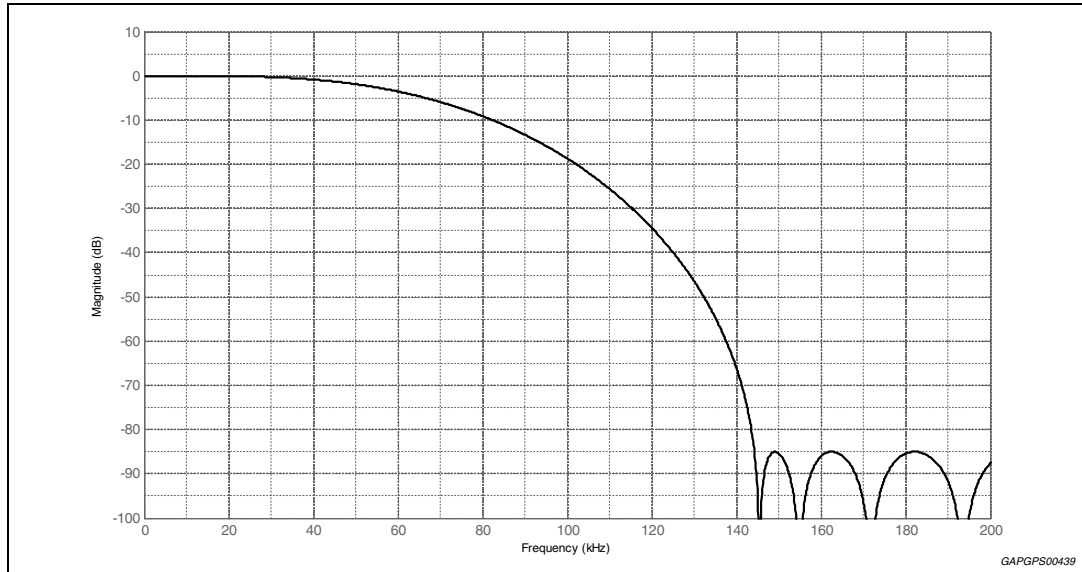

Table 13. Overall filter characteristics for AM

Item	Value	Unit
Pass-band edge	20	kHz
Stop-band edge	300	kHz
In-band ripple	<0.051	dB
Anti-alias Attenuation	>100	dB

3 Electrical specifications

3.1 Absolute maximum ratings

Table 14. Absolute maximum ratings

Symbol	Parameter	Test condition	Min	Typ	Max	Units
V_{CC}	Abs. supply voltage	-	-0.5	-	5.5	V
T_{stg}	Storage temperature	-	-55	-	150	°C
V_{ESD}	ESD absolute minimum withstand voltage	Human Body model	> ±2000			V
		Charged device model	> ±400			
		Charged device mode, corner pins	> ±750			
-	Max. input at any pin (latch-up characteristic)	I_{INMAX}	±100			mA

Note: For all pins 37-44, when set as input, injecting current cannot exceed 20 mA as it would lead to voltage at the pin above the abs max.

3.2 Thermal data

Table 15. Thermal data

Symbol	Parameter	Test condition	Value	Units
R_{th}	Thermal resistance	LQFP64 10x10, JEDEC 2s1p PCB	55	°C/W

3.3 General key parameters

Table 16. General key parameters

Symbol	Parameter	Test condition	Min	Typ	Max	Units
V_{CC}	5 V supply voltage	see note (1)	4.7	5	5.2	V
I_{CC}	supply current @ 5 V		-	175	225	mA
T_{amb}	Ambient temperature range	-	-40	-	85	°C
T_j	Operating junction temperature	-	-	-	150	°C
$V_{VCCREG12}$	VCCREG12 supply voltage	see note (2)	2.3	-	5.2	V
V_{1V2}	Digital core 1.2 V supply voltage	when supplied externally see note (3)	1.14	1.2	1.3	V
I_{1V2}	Digital core 1.2 V supply current	$V_{1V2} = 1.2V$ see note (3)	-	55	80	mA
V_{3V3}	Digital IO 3.3 V supply voltage	when supplied externally see note (4)	3.0	-	3.6	V

Table 16. General key parameters (continued)

Symbol	Parameter	Test condition	Min	Typ	Max	Units
I _{3V3}	Digital IO 3.3 V supply current	Maximum current specified only in case generated from Internal supply only	-	-	10	mA

1. FM functional test from antenna mixer input to audio output.
2. In the typical application supplied from 5 V with a 27 Ω series resistor.
Test condition: maximum current load for minimum value, unloaded for maximum value.
3. When the 1.2 V supply is applied externally, and not using the internal 1.2 V regulator.
Test condition: FM functional test from antenna mixer input to audio output.
4. When the 3.3 V supply is applied externally, and not using the internal 3.3 V regulator.

3.4 Electrical characteristics

V_{CC} = 4.7 V to 5.25 V; T_{amb} = -40 °C to +85 °C; unless otherwise specified.

3.4.1 FM - section

Table 17. FM - section

Symbol	Parameter	Test condition	Min	Typ	Max	Units
FM IMR Mixer						
RF Gain	Voltage gain (mix in -> s.e. test output)	RF gain 0	33	35	37	dB
		RF gain 1 ⁽¹⁾	36	38	40	
		RF gain 2	37	39	41	
		RF gain 3	39	41	43	
Vnoise low gain	Input noise voltage (RF gain 0)	Rsource=1.25 kΩ, noiseless	-	2.3	2.9	nV/√Hz
		Rsource=0	-	2.1	2.6	
Vnoise high gain	Input noise voltage (RF gain 3)	Rsource=1.25 kΩ, noiseless	-	1.9	2.4	nV/√Hz
		Rsource=0	-	1.6	2.0	
IIP3	3 rd order intercept point	RF gain 0, up to Vin/tone = 92 dBμV	124	127	-	dBμV
		RF gain 3, up to Vin/tone = 86 dBμV	119	122	-	
FM AGC						
RFAGC-Thr	RFAGC threshold, referred to mixer input; RF level	min setting, reg8<14>=1	85.4	88.4	91.4	dBμV
		max setting, reg8<14>=1	89	92	95	
		min setting, reg8<14>=0	88.4	91.4	94.4	
		max setting, reg8<14>=0	92	95	98	
	Threshold steps	-	1.3	1.8	2.3	dB
	Threshold error	@ T _{amb}	-1.5	-	1.5	dB
	Threshold temperature drift	-	-	0.016	-	dB/K

Table 17. FM - section (continued)

Symbol	Parameter	Test condition	Min	Typ	Max	Units
IFAGC-Thr	IFAGC threshold	min setting	120	122	124	dB μ V
		max setting	126	128	130	dB μ V
	Threshold steps	-	1.5	2	2.5	dB
	Threshold error	@ T _{amb}	-1.5	-	1.5	dB
	Threshold temperature drift	-	-	0.016	-	dB/K
Time constant	I attack	Slow attack	10	20	30	μ A
		Fast attack	100	200	300	
	I decay	Slow decay	1	2	5	
		Fast decay	10	20	30	
-	PIN diode source current	@ T _{amb} ⁽²⁾	-15	-	-	mA
-	PIN diode sink current	-	3	-	20	μ A
-	PIN diode source current in constant current mode	@ T _{amb}	-0.9	-	-	mA

1. The gain is internally 6 dB higher than what measured at the test output. This is due to the differential to single-ended conversion used for the test output.
2. The current is generated by a PTAT (proportional to absolute temperature) source, and has therefore a temperature dependency described by: $\Delta I/I_0 = \Delta T/T_0$, with I₀ being the current at ambient temperature (25 °C) and T₀ the ambient temperature (25 °C) expressed in Kelvin, that is 298K.

3.4.2 AM - section

Table 18. AM - section

Symbol	Parameter	Test condition	Min	Typ	Max	Units
AM IMR Mixer						
Gain	Voltage gain (mix in -> s.e. test output) ⁽¹⁾	normal	20	22	24	dB
		reduced	17	19	21	
R _{in}	Input resistance	-	20	30	45	k Ω
V _{noise}	Input noise voltage	Mix 1, 2 R _{source} = 1 k Ω , noise-less	-	7.5	9	nV/ \sqrt Hz
IIP3	3 rd order intercept point	Mix1, 2 up to Vin/tone = 90 dB μ V	128	132	-	dB μ V
IIP2	2 nd order intercept point	Mix1, 2 up to Vin/tone = 90 dB μ V	152	158	-	dB μ V
LO hsupp	LO harmonic suppression	-	80	-	-	dB
AM LNA						
Gain	Voltage gain	Max gain, R _{ext} = 470 Ω	24	28	32	dB
		Min gain (AGC controlled)	8	12	16	
R _{in}	Input resistance	-	600	950	1300	k Ω
C _{in}	input capacitance	-	-	20	-	pF

Table 18. AM - section (continued)

Symbol	Parameter	Test condition	Min	Typ	Max	Units
V _{noise}	Input noise voltage	-	-	0.7	1.0	nV/√Hz
IIP3	3 rd order intercept point	@ maximum LNA gain	116	120	-	dBμV
IIP2	2 rd order intercept point	@ maximum LNA gain	121	127	-	dBμV
AM PIN diode						
IIP2	2 rd order intercept point	Full attenuation, C _{source} = 80 pF, f = 1 MHz	134	140	-	dBμV
Res	Minimum resistance	-	-	5	15	Ω
C _{in}	Input capacitance	High ohmic	-	2	-	pF
AM AGC						
AGC-Thr	Referred to mixer input; RF level	Mix 1,2 min setting	80	83	86	dBμV
		Mix 1,2 max setting	92.6	95.6	98.6	
Thr-steps	Threshold steps	-	1.3	1.8	2.3	dB
-	Threshold error	@ T _{amb}	-2.5	-	2.5	dB
-	Threshold temperature drift	-	-3	-	3	dB
-	PIN diode source current	@ T _{amb} See note ⁽²⁾	-10	-	-	mA
-	PIN diode sink current	-	15	30	45	μA
-	PIN diode source current in constant current mode	@ T _{amb} See note ⁽²⁾	-1	-	-	mA

1. The gain is internally 6 dB higher than what measured at the test output. This is due to the differential to single-ended conversion used for the test output.
2. The current is generated by a PTAT (proportional to absolute temperature) source, and has therefore a temperature dependency described by: $\Delta I/I_0 = \Delta T/T_0$, with I₀ being the current at ambient temperature (25 °C) and T₀ the ambient temperature (25 °C) expressed in Kelvin, that is 298K.

3.4.3 VCO

Table 19. VCO

Symbol	Parameter	Test condition	Min	Typ	Max	Units
f _{VCO,min}	Minimum VCO oscillation frequency ⁽¹⁾	-	-	-	2.34	GHz
f _{VCO,max}	Maximum VCO oscillation frequency ⁽²⁾	-	3.025	-	-	GHz
PN	Phase noise of LO	Locked VCO; values referred @ 100MHz @ 100 Hz @ 1 kHz @ 10 kHz	-	-105 -115 -115	-	dBc/Hz
dev	deviation error (RMS)	FM reception, deemphasis 50 μs, f _{audio} =20 Hz...20 kHz	-	5	8	Hz

1. Limited by application Firmware to 2.1 GHz.
2. Limited by application Firmware to 3.1 GHz.

3.4.4 Phase locked loop

Table 20. Phase locked loop

Symbol	Parameter	Test condition	Min	Typ	Max	Units
T_{settle}	Settling time FM	$\Delta f < 10$ kHz	-	100	140	μs
FM step	FM Frequency step	-	-	5	-	kHz
AM step	AM frequency step	-	-	500	-	Hz

3.4.5 Tuning DAC

Table 21. Tuning DAC

Symbol	Parameter	Test condition	Min	Typ	Max	Units
R_{es}	Resolution	8 bit	14	18	22	mV
V_{outmin}	Min output voltage	-	-	0.6	0.75	V
V_{outmax}	Max output voltage	-	VCC-0.25	VCC-0.15	-	V
R_{out}	Output impedance	-	1.5	2.5	3.5	k Ω
DNL	Diff. Nonlinearity	-	-	-	0.5	LSB
T_{conv}	Conversion time	Without capacitive load	-	20	-	μs

3.4.6 IF ADC

Table 22. IF ADC

Symbol	Parameter	Test condition	Min	Typ	Max	Units
DR_{FM}	Dynamic range in FM	BW = ± 100 kHz	87	90	-	dB
v_{noiseFM}	Input noise referred to mixer input	RF gain 2	1.7	0.94	-	nV/ $\sqrt{\text{Hz}}$
DR_{AM}	Dynamic range in AM	BW = ± 3 kHz	105	108	-	dB
v_{noiseAM}	Input noise referred to mixer input	normal gain	6.3	3.2	-	nV/ $\sqrt{\text{Hz}}$
$DR_{\text{FM-HD}}$	Dynamic range in FM-IBOC	BW = ± 200 kHz	82	85	-	dB
$V_{\text{noiseFM-HD}}$	Input noise referred to mixer input	RF gain 2	2.3	1.2	-	nV/ $\sqrt{\text{Hz}}$
$DR_{\text{AM-HD}}$	Dynamic range in AM-IBOC	BW = ± 15 kHz	97	100	-	dB
$v_{\text{noiseAM-HD}}$	Input noise referred to mixer input	normal gain	5.6	2.9	-	nV/ $\sqrt{\text{Hz}}$

3.4.7 Audio DAC

Table 23. Audio DAC

Symbol	Parameter	Test condition	Min	Typ	Max	Units
V_{out}	Max. output voltage	Full scale	1.2	1.4	-	Vrms
BW	Pass-band	0.01dB attenuation	-	20	-	KHz
Rout	Output resistance	-	100	150	200	Ω
multipath	Output noise	-	-	14	30	μ Vrms
D	Distortion	-6 dBFS	-	0.03	0.05	%

3.4.8 IO interface pins

Table 24. IO interface pins

Symbol	Parameter	Test condition	Min	Typ	Max	Units
-	High level output voltage	Unloaded	2.9	3.2	-	V
-	Low level output voltage	Unloaded	-	0.1	0.3	V
-	Input voltage range	-	0	-	3.5	V
-	High level input voltage	-	2.0	-	-	V
-	Low level input voltage	-	-	-	0.8	V
T_{reset}	Reset time	Minimum time during which pin RSTN must be low so as to reset the device	10	-	-	μ s
T_{latch}	Boot mode configuration latch time	Minimum time during which the voltage applied at pins 32 and 39 must be driven in order to latch the correct control serial bus address configuration	10	-	-	μ s

3.4.9 I²C interface

The I²C protocol serial bus communication parameters of the following table are defined as in [Figure 18](#).

Table 25. I²C interface

Symbol	Parameter	Test condition	Min	Typ	Max	Units
f _{SCL}	SCL Clock frequency	-	-	-	500	kHz
t _{AA}	SCL low to SDA data valid	-	0.3	-	-	µs
t _{buf}	Time the bus must be kept free before a new transmission	-	1.3	-	-	µs
t _{HD-STA}	START condition hold time	-	0.6	-	-	µs
t _{LOW}	Clock low period	-	1.3	-	-	µs
t _{HIGH}	Clock high period	-	0.6	-	-	µs
t _{SU-SDA}	START condition setup time	-	0.1	-	-	µs
t _{HD-DAT}	Data input hold time	-	0	-	0.9	µs
t _{SU-DAT}	Data input setup time	-	0.1	-	-	µs
t _R	SDA & SCL rise time	-	-	-	0.3	µs
t _F	SDA & SCL full time	-	-	-	0.3	µs
t _{SU-STOP}	Stop condition setup time	-	0.6	-	-	µs
t _{DH}	Data out time	-	-	-	0.3	µs

Figure 18. I²C bus timing diagram

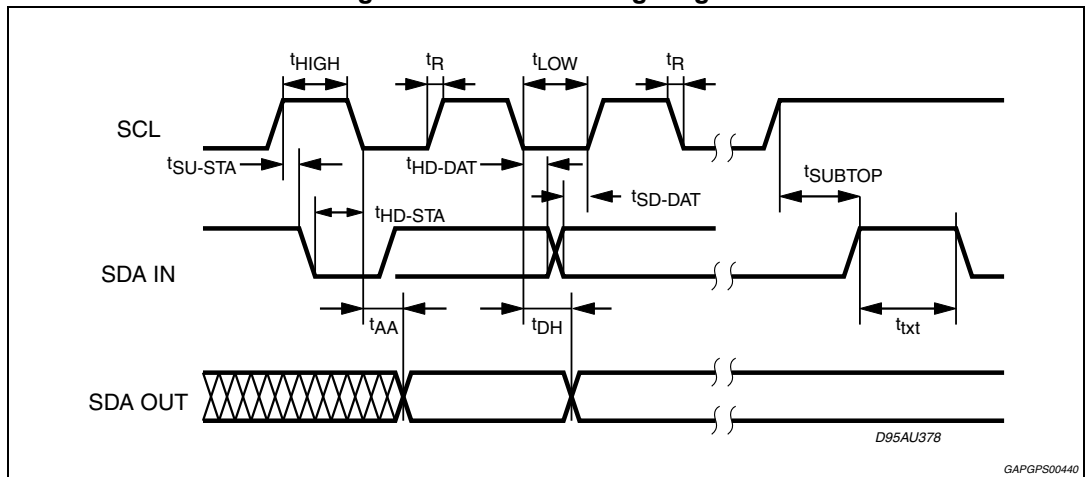

3.5 Overall system performance

3.5.1 FM overall system performance

Antenna level equivalence: 0 dBμV = 1 μVrms (Antenna terminal voltage with 75 Ω dummy load).

Figure 19. FM input set-up

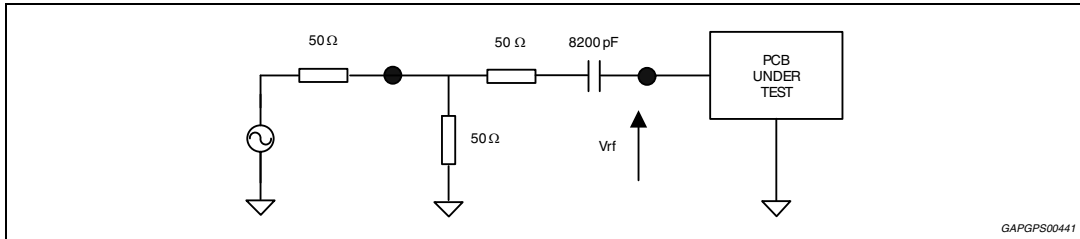

Input level referred to 75 Ω antenna dummy output. $F_{rf} = 98.1 \text{ MHz}$, $V_{rf} = 60 \text{ dB}\mu\text{V}$, mono modulation, $f_{dev} = 40 \text{ kHz}$, $f_{audio} = 1 \text{ kHz}$ audio. De-emphasis = 50 μs. Wide-band, not-tuned pre-selection application, unless otherwise specified.

Table 26. FM overall system performance

Parameter	Test condition	Min	Typ	Max	Units
Tuning range FM Eu	(can be modified by the user) (automatic FE alignment available)	87.5	-	108	MHz
Tuning step FM Eu	(can be modified by the user)	-	100	-	kHz
Tuning range FM US	(can be modified by the user) (automatic FE alignment available)	87.5	-	107.9	MHz
Tuning step FM US	(can be modified by the user)	-	200	-	kHz
Tuning range FM Jp	(can be modified by the user) (automatic FE alignment available)	76	-	90	MHz
Tuning step FM Jp	(can be modified by the user)	-	100	-	kHz
Tuning range FM EEu	(can be modified by the user) (automatic FE alignment not available)	65	-	74	MHz
Tuning step FM EEu	(can be modified by the user)	-	100	-	kHz
Sensitivity	S/N = 26 dB	-	-6	-3	dBμV
S/N	@ 10 dBμV, no high-cut, DISS BW = #4	49	52	-	dB
Ultimate S/N	@ 60 dBμV, mono	77	80	-	dB
	@ 60 dBμV, Deviation = 75 kHz, mono	82	85	-	dB
	@ 60 dBμV, stereo	67	70	-	dB

Table 26. FM overall system performance (continued)

Parameter	Test condition	Min	Typ	Max	Units
Distortion	Deviation= 75 kHz	-	0.05	0.1	%
Max deviation	THD=3%	150	166	-	kHz
Adjacent channel Selectivity (D/U ratio)	$\Delta F = 100$ kHz, SINAD=30 dB Desired 40 dB μ V, dev = 40 kHz, 400 Hz undesired Dev=40 kHz, 1 kHz	20	30	-	dB
Alternate Channel Selectivity (D/U ratio)	$\Delta F = 200$ kHz, SINAD=30 dB Desired 40 dB μ V, dev = 40 kHz, 400 Hz undesired Dev=40 kHz, 1 kHz	52	62	-	dB
Max. Strong Signal Interferer (D/U ratio)	Desired = 40 dB μ V SINAD = 30 dB Undesired $\Delta F = 1$ MHz	75	80	-	dB
3 signal performance ("wide-band") application	Desired = 40 dB μ V, dev = 40 kHz, 400 Hz, SINAD = 30 dB Undesired1 = ± 400 kHz, dev = 40 kHz, 1 kHz Undesired2 = ± 800 kHz, no mod	101	106	-	dB μ V
	Desired = 40 dB μ V, dev = 40 kHz, 400 Hz, SINAD = 30 dB Undesired1 = ± 1 MHz, dev = 40 kHz, 1 kHz Undesired2 = ± 2 MHz, no mod	105	110	-	dB μ V
AM suppression	m= 30 %	60	70	-	dB
Logarithmic field strength indicator	@40 dB μ V read "FM_Smeter_log"	-0.41 (equivalent to 37 dB μ V)	-0.38	-0.35 (equivalent to 43 dB μ V)	-

3.5.2 AM MW overall system performance

Antenna level equivalence: 0 dBμV = 1 μVrms

Figure 20. AM MW input set-up

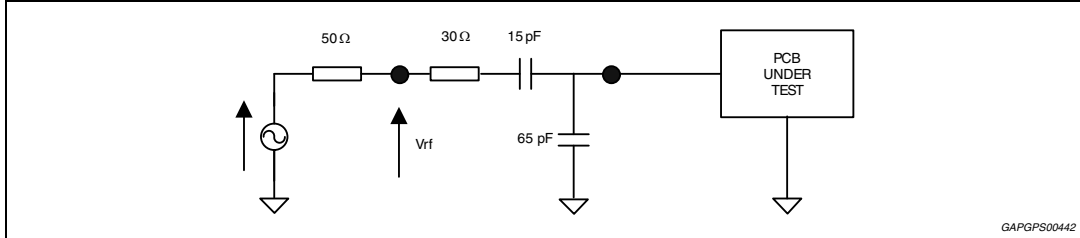

Level referred to SG EMF output before antenna dummy; dummy antenna load as shown above $F_{rf} = 999$ kHz (1000 kHz for US), $V_{rf} = 74$ dBμV, mod = 30 %, $f_{audio} = 400$ Hz, unless otherwise specified.

Table 27. AM MW overall system performance

Parameter	Test condition	Min	Typ	Max	Units
Tuning range MW Eu/Jp	(can be modified by the user)	531	-	1629	kHz
Tuning step MW Eu/Jp	(can be modified by the user)	-	9	-	kHz
Tuning range MW US	(can be modified by the user)	530	-	1710	kHz
Tuning step MW US	(can be modified by the user)	-	10	-	kHz
Sensitivity	S/N = 20 dB	-	25	28	dBμV
Ultimate S/N	@ 80 dBμV	67	72	-	dB
AGC F.O.M.	Ref.=74 dBμV -10dB drop point	(1)	64	-	dB
Distortion	M=80%	-	0.1	0.2	%
Adjacent channel selectivity	$\Delta F = 9$ kHz, SINAD = 26 dB undesired M = 30 % 1 kHz	44	47	-	dB
Alternate channel selectivity	$\Delta F = 18$ kHz, SINAD = 26 dB undesired M = 30 % 1 kHz	48	51	-	dB
Strong signal interferer (1) SNR	$\Delta F = \pm 40$ kHz desired = 40 dBμV undesired = 110 dBμV, m = 30 % 1 kHz	8	12	-	dB
Strong signal interferer (1) suppression	$\Delta F = \pm 40$ kHz desired = 40 dBμV undesired = 110 dBμV, m = 30 % 1 kHz	-	10	15	dB
Strong signal interferer (1) cross-modulation	$\Delta F = \pm 40$ kHz desired = 80 dBμV undesired = 110 dBμV, m = 30 % 1 kHz maximum SNR of undesired channel	-	1	4	dB

Table 27. AM MW overall system performance (continued)

Parameter	Test condition	Min	Typ	Max	Units
Strong signal interferer (2) SNR	$\Delta F = \pm 400$ kHz desired = 40 dB μ V undesired = 110 dB μ V, m = 30 %, 1 kHz	5	11	-	dB
Strong signal interferer (2) suppression	$\Delta F = \pm 400$ kHz desired = 40 dB μ V undesired = 110 dB μ V, m = 30 %, 1 kHz	-	15	18	dB
Strong signal interferer (2) cross-modulation	$\Delta F = \pm 400$ kHz desired = 80 dB μ V undesired = 110 dB μ V, m = 30 %, 1 kHz maximum SNR of undesired channel	-	1	4	dB
Max. strong signal interferer	Desired = 40 dB μ V SINAD = 26dB, blocking < 6dB Undesired $\Delta F = 400$ kHz, m = 30 % (crossmod. Test)	90	98	-	dB μ V
Image rejection	-	60	80	-	dB
Logarithmic field strength indicator	@60 dB μ V read "AM_SMeter_log"	-0.47 (equivalent to 57 dB μ V)	-0.44	-0.41 (equivalent to 63 dB μ V)	-

1. Programmable by software parameters.

3.5.3 AM LW overall system performance

Antenna level equivalence: 0 dBμV = 1 μVrms

Figure 21. AM LW input set-up

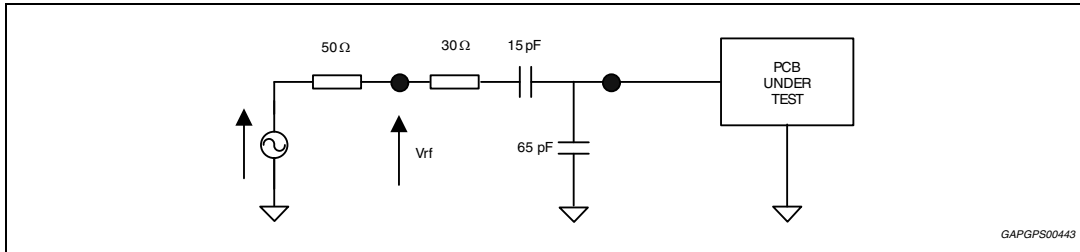

Level referred to SG EMF output before antenna dummy; dummy antenna load as shown above; $F_{rf} = 216$ kHz, $V_{rf} = 74$ dBμV, mod = 30 %, $f_{audio} = 400$ Hz, unless otherwise specified.

Table 28. AM LW overall system performance

Parameter	Test condition	Min	Typ	Max	Units
Tuning range LW	(can be modified by the user)	144	-	288	kHz
Tuning step LW	(can be modified by the user)	-	1	-	kHz
Sensitivity	S/N = 20 dB	-	30	34	dBμV
Ultimate S/N	@ 80 dBμV	63	70	-	dB
AGC F.O.M.	Ref. = 74 dBμV -10dB drop point	(1)	64	-	dB
Distortion	M= 80 %	-	0.1	0.2	%
Image rejection	-	60	80	-	dB

1. Programmable by software parameters.

3.5.4 AM SW overall system performance

Antenna level equivalence: 0 dBμV = 1 μVrms

Figure 22. AM SW input set-up

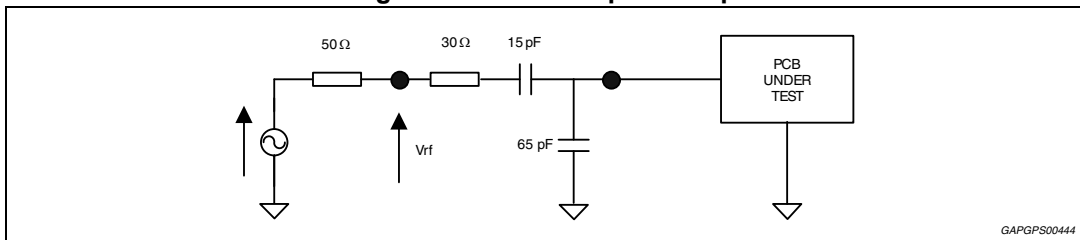

Level referred to SG EMF output before antenna dummy; dummy antenna load as shown above; $F_{rf} = 6000$ kHz, $V_{rf} = 74$ dBμV, mod = 30 %, $f_{audio} = 400$ Hz, unless otherwise specified.

Table 29. AM SW overall system performance

Parameter	Test condition	Min	Typ	Max	Units
Tuning range SW	(can be modified by the user)	2300	-	30000	kHz
Tuning step SW	(can be modified by the user)	-	1	-	kHz
Sensitivity	S/N = 20 dB	-	26	32	dB μ V
Ultimate S/N	@ 80 dB μ V	63	70	-	dB
AGC F.O.M.	Ref.=74 dB μ V -10 dB drop point	(1)	58	-	dB
Distortion	M = 80%	-	0.1	0.2	%
Image rejection	-	60	80	-	dB

1. Programmable by software parameters.

3.5.5 WX overall system performance

Antenna level equivalence: 0 dB μ V = 1 μ Vrms (Antenna terminal voltage with 75 Ω dummy load).

Figure 23. WX input set-up

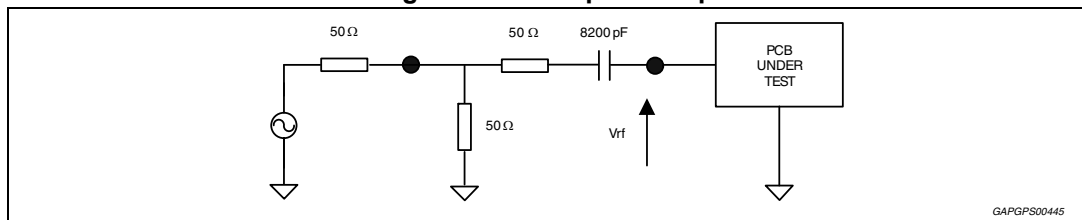

Input level referred to 75 Ω dummy antenna output; antenna dummy as shown above.
 $F_{rf} = 162.475$ MHz, $V_{rf} = 60$ dB μ V, mono modulation, $f_{dev} = 3$ kHz, $f_{audio} = 400$ Hz audio.
 De-emphasis = 75 μ s. Application WX using mixer input 2. Unless otherwise specified.

Table 30. WX overall system performance

Parameter	Test condition	Min	Typ	Max	Units
Sensitivity	S/N = 26 dB	-	-6	-3	dB μ V
Ultimate S/N	@ 60 dB μ V	70	81	-	dB
Distortion	Deviation= 4.5 kHz	-	0.8	1	%
Max deviation	THD = 3%	5	-	-	kHz
Adjacent channel Selectivity	$\Delta F = 25$ kHz, SINAD = 30dB desired 40 dB μ V, dev = 2.0 kHz, 400 Hz undesired Dev = 2.0 kHz, 1 kHz	60	70	-	dB
Alternate Channel Selectivity	$\Delta F = 50$ kHz, SINAD = 30dB desired 40 dB μ V, dev = 2.0 kHz, 400 Hz undesired Dev = 2.0 kHz, 1 kHz	60	70	-	dB

4 Front-end registers

All the parameters in this section refer to the programmability of the FE part of the device (registers). The part of the registers that are not described here have either fixed values or values written by the tuner drivers, and are described in the proper technical documentation.

Table 31. Register 0x00

Register number																								Register definition			
MSB																						LSB					
23	22	21	20	19	18	17	16	15	14	13	12	11	10	9	8	7	6	5	4	3	2	1	0				
																								AM mixer input selector			
																						0	1	Input #1			
																						1	0	Input #2			
																								AM PIN diode			
												0													Internal		
												1													External		
																								AM AGC mode			
												0													LNA and PIN diode		
												1													PIN diode only		
																								AM AGC time constant			
														0	0											Slow (125 ms with 1 μ F)	
														0	1											Medium (25ms with 1 μ F)	
														1	1											Fast (5ms with 1 μ F)	
																								AM AGC thresholds @ mixin			
																		0	0	0							90.2 dB μ V @ mixin
																		0	0	1							92.0 dB μ V @ mixin
																		0	1	0							93.8 dB μ V @ mixin
																		0	1	1							95.6 dB μ V @ mixin
																		1	0	0							88.4 dB μ V @ mixin
																		1	0	1							86.6 dB μ V @ mixin
																		1	1	0							84.8 dB μ V @ mixin
																		1	1	1							83 dB μ V @ mixin
																								AM AGC attack time constant			
																				0					Normal		
																				1					Fast		

Table 32. Register 0x01

Register number																				Register definition					
MSB																			LSB						
23	22	21	20	19	18	17	16	15	14	13	12	11	10	9	8	7	6	5	4			3	2	1	0
																				FM mixer RF-gain					
																					0	0		35 dB	
																						0	1		38 dB
																						1	0		39 dB
																						1	1		41 dB
																				FM mixer input					
																									Input #1 (single-ended)
																									Input #2 (single-ended)
																									Input #1/2 (differential)
																				FM AGC output mode					
0	0																							Normal	
0	1																							Constant 15mA	
1	1																							Constant 1mA	

Table 33. Register 0x02

Register Number																Register Definition										
MSB											LSB															
23	22	21	20	19	18	17	16	15	14	13	12	11	10	9	8			7	6	5	4	3	2	1	0	
FM RF AGCThresholds@ mixin																										
																					0	0	88.4 dB μ V	Reg 0x008<14> = 1		
																							0		1	90.2 dB μ V
																							1		0	92.0 dB μ V
																							1		1	93.8 dB μ V
																							0	0	91.4 dB μ V	Reg 0x008<14> = 0
																							0	1	93.2 dB μ V	
																							1	0	95.0 dB μ V	
																							1	1	96.8 dB μ V	
FM IFAGC threshold@IFADCin																										
																						0	0	122 dB μ V		
																							0	1	124 dB μ V	
																							1	0	126 dB μ V	
																							1	1	128 dB μ V	
FMAGC attack time constant																										
																						0		slow		
																						1		fast		
FMAGC decay time constant																										
																						0		slow		
																						1		fast		
FM DAC																										
																						0		off		
																						1		on		
FM DAC VALUE																										
																									0	
																									1	
																									...	
																									255	

Table 34. Register 0x05

Register Number																								Register Definition
MSB												LSB												
23	22	21	20	19	18	17	16	15	14	13	12	11	10	9	8	7	6	5	4	3	2	1	0	
																								GPODATA
																								0 low
																								1 high

Table 35. Register 0x08

Register number																								Register definition
MSB												LSB												
23	22	21	20	19	18	17	16	15	14	13	12	11	10	9	8	7	6	5	4	3	2	1	0	
																								FMAGC gain select
																								0 FM AGC thresholds high
																								1 FM AGC thresholds down

5 Weak signal processing

All the parameters in this section refer to the programmability of the DSP part of the device. The typical values are those set by default parameters (start-up without parametric change from main microprocessor); the max and the min values refer to the programmability range. The values are referred to the typical application ('wide-band' in FM). Wherever the possible values are a discrete set, all the possible programmable values are displayed.

5.1 FM IF-processing

5.1.1 Dynamic channel selection filter (DISS)

Table 36. Dynamic channel selection filter (DISS) - discrete set

Symbol	Parameter	Test condition	Min	Typ	Max	Units
DISS BW	IF filter #10	response: - 3dB	-	±150	-	kHz
	IF filter #9		-	±120	-	kHz
	IF filter #8		-	±100	-	kHz
	IF filter #7		-	±85	-	kHz
	IF filter #6			±75	-	kHz
	IF filter #5			±65	-	kHz
	IF filter #4			±60	-	kHz
	IF filter #3			±55	-	kHz
	IF filter #2		-	±45	-	kHz
	IF filter #1		-	±35	-	kHz
	IF filter #0		-	±25	-	kHz

5.1.2 Soft mute

Table 37. Soft mute - continuous set

Symbol	Parameter	Test condition	Min	Typ	Max	Units
SMsp	Start point vs. field strength	audio atten = 1 dB read "FM_SoftMute" no adjacent channel present	0	6	20	dBµV
SMep	End point vs. field strength	audio atten = SMd + 1 dB read "FM_SoftMute" no adjacent channel present	-6	-6	10	dBµV
SMd	Depth		-30	-15	0	dB
SMtauatt	Field strength LPF cut-off frequency for soft mute activation		0.1	100	4000	Hz
SMtaurel	Field strength LPF cut-off frequency for soft mute release		0.1	1	4000	Hz

5.1.3 Adjacent channel mute

Table 38. Adjacent channel mute - continuous set

Symbol	Parameter	Test condition	Min	Typ	Max	Units
ACMd	Depth	-	SMd	0	0	dB

5.1.4 Stereo blend

Table 39. Stereo blend - continuous set

Symbol	Parameter	Test condition	Min	Typ	Max	Units
MaxSep	Maximum stereo separation	field strength = 80 dB μ V, pilot deviation = 6.75 kHz	0	40	50	dB
SBFSsp	Start point vs. field strength	separation = MaxSep - 1 dB no multipath present	20	50	60	dB μ V
SBFSep	End point vs. field strength	separation = 1 dB no multipath present	20	30	60	dB μ V
SBFStM2S	Field strength-related transition time from mono to stereo	V _{rf} step-like variation from 20 dB μ V to 80 dB μ V	0.001	3	20	s
SBFStS2M	Field strength-related transition time from stereo to mono	V _{rf} step-like variation from 80 dB μ V to 20 dB μ V	0.001	0.5	20	s
SBMPsp	Start point vs. multipath	separation = MaxSep - 1 dB equivalent 19 kHz AM modulation depth; field strength = 80 dB μ V	5	10	80	%
SBMPep	End point vs. multipath	separation = 1 dB equivalent 19 kHz AM modulation depth; field strength = 80 dB μ V	5	30	80	%
SBMPtM2S	Multipath-related transition time from mono to stereo	V _{rf} step-like variation from 20 dB μ V to 80 dB μ V	0.001	1	20	s
SBMPtS2M	Multipath-related transition time from stereo to mono	V _{rf} step-like variation from 80 dB μ V to 20 dB μ V	0.001	0.001	20	s
Pil ThrM2S	Pilot detector stereo threshold	Threshold on pilot tone deviation for mono-stereo transition	0.8	2.74	-	kHz
Pil ThrHyst	Pilot detector threshold hysteresis	Difference in Pil. det. deviation threshold for stereo to mono transition compared to PilThrM2S	-	0.01	-	kHz

5.1.5 High cut control

Table 40. High cut control - continuous set

Symbol	Parameter	Test condition	Min	Typ	Max	Units
HCFSsp	Start point vs. field strength	minimum RF level for widest HC filter (filter # 7) no multipath present	0	50	50	dB μ V
HCFSep	End point vs. field strength	maximum RF level for narrowest HC filter (filter # 0) no multipath present	0	30	40	dB μ V
HCFS _t W2N	Field strength-related transition time from wide to narrow band	V_{rf} step-like variation from 60 dB μ V to 10 dB μ V	(1)			-
HCFS _t N2W	Field strength-related transition time from narrow to wide band	V_{rf} step-like variation from 0 dB μ V to 60 dB μ V	(1)	14	100	s
HCMPsp	Start point vs. multipath	minimum RF level for widest HC filter (filter # 7) equivalent 19 kHz AM modulation depth; field strength = 80 dB μ V	5	10	150 ⁽²⁾	%
HCMPep	End point vs. multipath	maximum RF level for narrowest HC filter (filter # 0) equivalent 19 kHz AM modulation depth; field strength = 80 dB μ V	5	30	150 ⁽²⁾	%
HCMP _t N2W	Multipath-related transition time from narrow to wide band	V_{rf} step-like variation from 20 dB μ V to 80 dB μ V	0.001	0.001	20	s
HCMP _t W2N	Multipath-related transition time from wide to narrow	V_{rf} step-like variation from 80 dB μ V to 20 dB μ V	0.001	0.001	20	s
HCmaxBW	Maximum cut-off frequency of high cut filter bank	Filter #7, -3 dB response frequency, input signal with pre-emphasis	HCminBW	14	18	kHz
HCminBW	Minimum cut-off frequency of high cut filter bank	Filter #0, -3 dB response frequency, input signal with pre-emphasis	0.1	3	HCmaxBW	kHz
HCnumFilt	Number of discrete HC filters	-	-	8 ⁽³⁾	-	-

1. Depends only on field strength filter time constant.

2. Means that 100% equivalent 19 kHz AM modulation depth will not achieve full band narrowing.

3. Intermediate filters (#6 - #1) cut-off frequencies exponentially spaced between HCmaxBW and HCminBW.

Table 41. De-emphasis filter - continuous set

Symbol	Parameter	Test condition	Min	Typ	Max	Units
DEtc	De-emphasis time constant 1	-	-	50	-	µs
	De-emphasis time constant 2	-	-	75	-	

5.1.6 Stereo decoder

Table 42. Stereo decoder - continuous set

Symbol	Parameter	Test condition	Min	Typ	Max	Units
PilSup	Pilot signal suppression	Pilot 9%, 19 kHz, ref = 40 kHz	-	60	-	dB
SubcSup	Subcarrier suppression	f = 38 kHz	-	70	-	dB
		f = 57 kHz	-	70	-	dB
		f = 76 kHz	-	80	-	dB

5.2 AM IF-processing

5.2.1 Channel selection filter

Table 43. Channel selection filter

Symbol	Parameter	Test condition	Min	Typ	Max	Units
CSF BW	Channel selection filter BW	response: - 3dB	-	±3.7	-	kHz

5.2.2 Soft mute

Table 44. Soft mute - continuous set

Symbol	Parameter	Test condition	Min	Typ	Max	Units
SMsp	Start point vs. field strength	audio atten = 1 dB read "FM_SoftMute" no adjacent channel present	0	25	40	dBµV
SMep	End point vs. field strength	audio atten = SMd + 1 dB read "FM_SoftMute" no adjacent channel present	0	0	30	dBµV
SMd	Depth	-	-40	-24	0	dB
SMtauatt	Transition time for field strength-dependent soft mute activation	-	0.001	0.1	10	s
SMtaurel	Transition time for field strength-dependent soft mute release	-	0.001	3	10	s

5.2.3 High cut control

Table 45. High cut control - continuous set

Symbol	Parameter	Test condition	Min	Typ	Max	Units
HCFSsp	Start point vs. field strength	minimum RF level for widest HC filter (filter # 7) no multipath present	0	40	50	dB μ V
HCFSep	End point vs. field strength	maximum RF level for narrowest HC filter (filter # 0) no multipath present	0	30	50	dB μ V
HCFS _{tW2N}	Field strength-related transition time from wide to narrow band	V _{rf} step-like variation from 60 dB μ V to 10 dB μ V	0.001	0.2	20	s
HCFS _{tN2W}	Field strength-related transition time from narrow to wide band	V _{rf} step-like variation from 0 dB μ V to 60 dB μ V	0.001	10	20	s
HCmaxBW	Maximum cut-off frequency of high cut filter bank	Filter #7, -3 dB response frequency, input signal with pre-emphasis	HCmin BW	14	18	kHz
HCminBW	Minimum cut-off frequency of high cut filter bank	Filter #0, -3 dB response frequency, input signal with pre-emphasis	1	3	HCmaxBW	kHz
HCnumFilt	Number of discrete HC filters	-	-	8	-	-



6

Basic application schematic

Figure 24. FM wide-band application

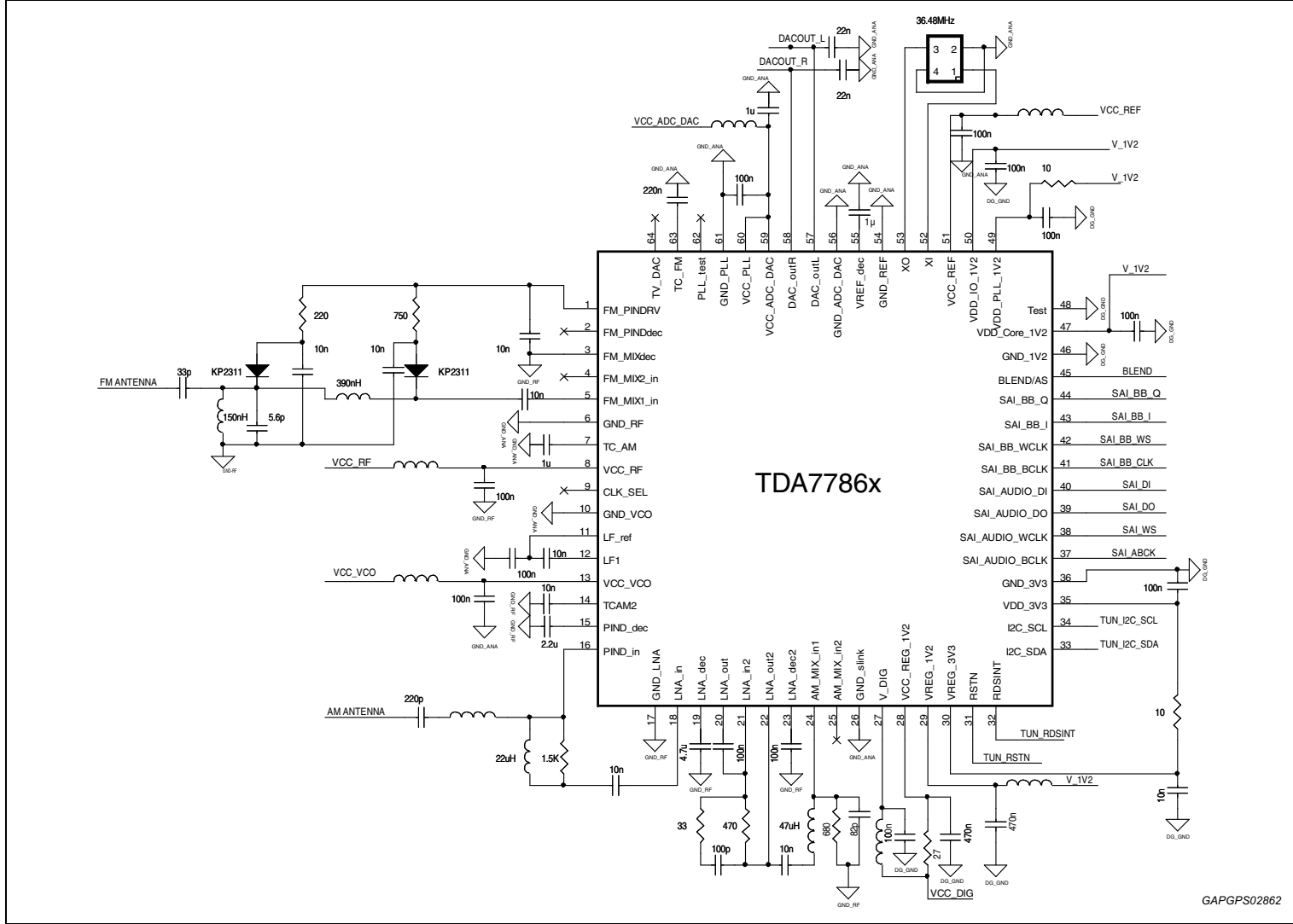

7 Package information

In order to meet environmental requirements, ST offers these devices in different grades of ECOPACK® packages, depending on their level of environmental compliance. ECOPACK® specifications, grade definitions and product status are available at: www.st.com.

ECOPACK® is an ST trademark.

7.1 LQFP64 (10x10x1.4 mm) package information

Figure 25. LQFP64 (10x10x1.4 mm) package outline

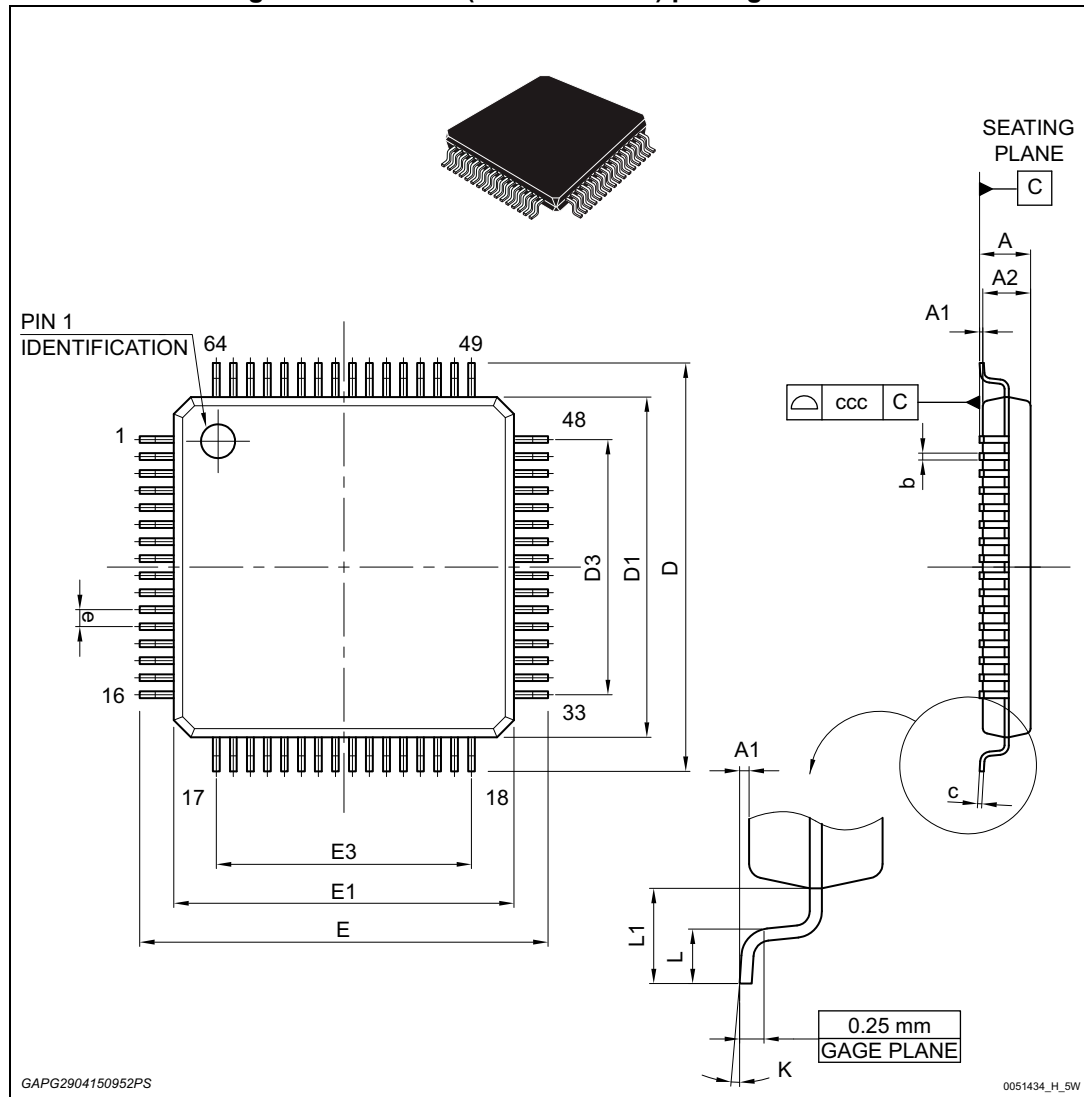

Table 46. LQFP64 (10x10x1.4 mm) package mechanical data

Ref	Dimensions					
	Millimeters			Inches ⁽¹⁾		
	Min.	Typ.	Max.	Min.	Typ.	Max.
A	-	-	1.60	-	-	0.0630
A1	0.05	-	0.15	0.0020	-	0.0059
A2	1.350	1.40	1.45	0.0531	0.0551	0.0571
b	0.17	0.22	0.27	0.0067	0.0087	0.0106
c	0.09	-	0.20	0.0035	-	0.0079
D	11.80	12.00	12.20	0.4646	0.4724	0.4803
D1	9.80	10.00	10.20	0.3858	0.3937	0.4016
D3	-	7.50	-	-	0.2953	-
E	11.80	12.00	12.20	0.4646	0.4724	0.4803
E1	9.80	10.00	10.20	0.3858	0.3937	0.4016
E3	-	7.50	-	-	0.2953	-
e	-	0.50	-	-	0.0197	-
L	0.45	0.60	0.75	0.0177	0.0236	0.0295
L1	-	1.00	-	-	0.0394	-
K	0° (min.), 3.5° (typ.) 7° (max.)					
ccc	-	-	0.08	-	-	0.0031

1. Values in inches are converted from mm and rounded to 4 decimal digits.

8 Revision history

Table 47. Document revision history

Date	Revision	Changes
24-Mar-2014	1	Initial release.
29-May-2014	2	Updated Table 3: Suggested GPIO direction and driving capability on page 15 .
23-Feb-2016	3	Document status promoted from preliminary data to production data. Added 'T _j ' parameter in Table 16: General key parameters on page 28 , and changed in note 2 the value of resistance from 15 to 27 Ω. Updated: – Figure 24: FM wide-band application on page 50 (pin 28 - from 15 to 27 Ω); – Section 7: Package information .
27-May-2016	4	Updated: – Title in cover page; – Features on page 1 and added new bullet "AEC-Q100 qualified"; – Description on page 1 ; – Table 1: Device summary on page 1 ; – Table 2: Pin description ; – Section 2.7: Audio D/A converters – Section 2.12: Digital high speed IO interface pins – Section 2.13: Multipath reduction ; – Section 2.14: HD Radio™ connectivity ; – Section 2.18: Digital-down-converter (DDC) Removed section 2.14 Antenna switching.
05-Oct-2016	5	The publication scope change from internal to public document, no content change.