

### Features

- High-density plug-in **Xilinx Spartan-6** module
- **USB 2.0 interface** with high-speed (480 Mbit/s) data rate
- Large **SPI Flash** for configuration and user data, accessible via FPGA, JTAG and USB interfaces
- Large **DDR3 SDRAM**
- FPGA configuration via **SPI, JTAG or USB**
- 3 high-efficiency on-board switch-mode **DC-DC converters**
- Power supply from B2B connector (carrier board) or USB connector
- Flexible expansion via high-density **shockproof B2B connectors**
- Most user I/Os on B2B connectors routed as **LVDS pairs**
- Evenly spread supply pins for good signal integrity
- **Industrial temperature grade** available upon request
- **Low-cost, versatile and ruggedized design**
- Small size

### Specifications

- **FPGA** - XC6SLX45/75/100/150-2CSG484C(I)
- **USB-controller**: CY7C68013A-56LTXC(I)
- **Non-volatile memory**: 64 Mbit SPI Flash for configuration and user data
- **Volatile memory**: 1 Gb x 16 DDR3 SDRAM
- Up to **110 FPGA user I/O**
- Supply voltage range: 4.0 V - 5.5 V
- 1 user push-button
- 4 user LEDs
- 2 user DIP switches
- Dimensions: **40.5 mm x 47.5 mm**

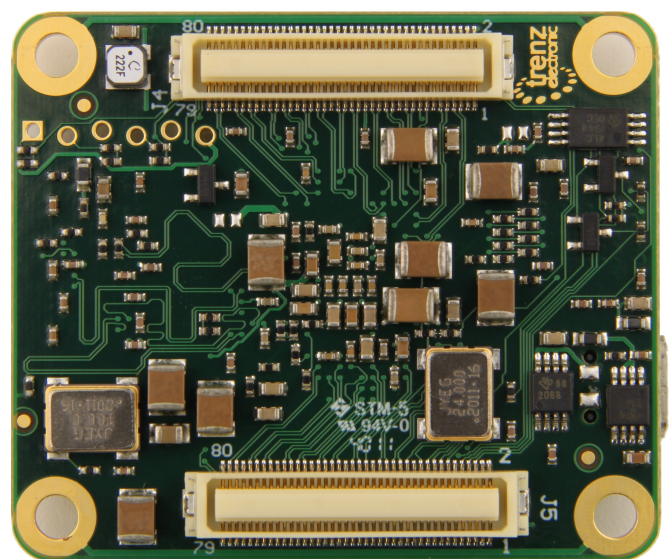
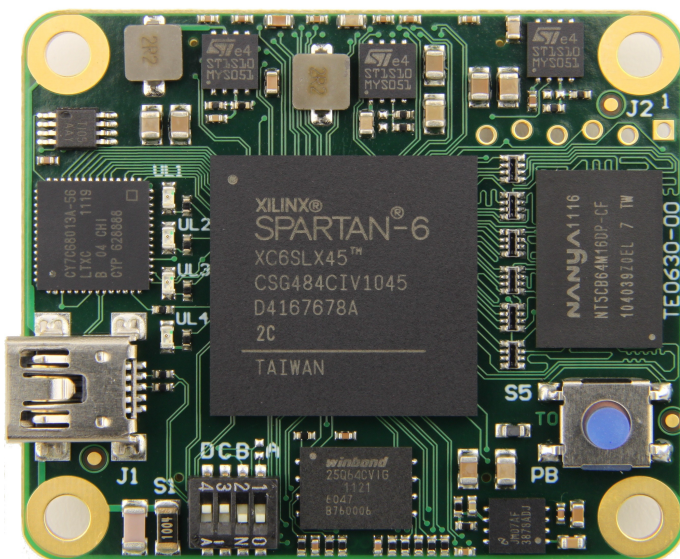

## Table of Contents

1	Technical Specifications.....	4
1.1	Module options.....	4
1.2	Dimensions.....	4
2	Detailed Description.....	5
2.1	Block Diagram.....	5
2.2	Power Supply.....	5
2.2.1	Supply from B2B Connector.....	5
2.2.2	Supply from USB Connector.....	5
2.2.3	On-board Power Rails.....	6
2.2.4	Power-on Reset.....	7
2.3	FPGA User I/Os.....	8
2.4	Board-to-board Connectors.....	9
2.5	USB Connector.....	10
2.6	JTAG connector.....	11
2.7	Serial EEPROM.....	11
2.8	SPI Flash.....	11
2.9	DDR3 SDRAM.....	12
2.10	USB Controller.....	12
2.11	Clock Oscillators.....	13
2.12	LEDs.....	13
2.13	Push-Button.....	14
2.14	DIP Switch.....	14
2.15	Board revisions and assembly variants.....	14
3	TE0300 compatibility.....	15
3.1	Mechanical compatibility.....	15
3.2	Electrical compatibility.....	15
4	Module Configuration.....	17
4.1	JTAG FPGA Configuration.....	17
4.2	SPI FPGA Configuration.....	18
4.3	eFUSE programming.....	18
4.4	EZ-USB FX2 Firmware Programming.....	18
4.5	EZ-USB FX2 EEPROM Programming.....	19
5	USB Drivers Installation.....	21
5.1	Generic Driver.....	21
5.2	Dedicated Driver.....	24
6	B2B Connectors Pin Descriptions.....	26
6.1	Pin Labelling.....	27
6.2	Pin Types.....	27
6.3	J4 Pin-out.....	28
6.4	J5 Pin-out.....	29
6.5	Signal Integrity Considerations.....	30
7	Related Materials and References.....	30
7.1	Data Sheets.....	30
7.2	User Guides.....	30
8	Glossary of Abbreviations and Acronyms.....	30
9	Legal Notices.....	31
9.1	Document Warranty.....	31
9.2	Limitation of Liability.....	31
9.3	Copyright Notice.....	31

9.4 Technology Licenses.....	32
10 Environmental Protection.....	33
10.1 REACH (Registration, Evaluation, Authorisation and Restriction of Chemicals) Compliance Statement.....	33
10.2 RoHS (Restriction of Hazardous Substances) compliance statement.....	33
10.3 WEEE (Waste Electrical and Electronic Equipment).....	33
Appendix A. Indirect SPI Programming using iMPACT.....	35
Document Change History.....	39

---

# 1 Technical Specifications

## 1.1 Module options

### FPGA options

Module can be ordered with Spartan-6 XC6SLX45, XC6SLX75, XC6SLX100, XC6SLX150 chip<sup>1</sup>.

### Temperature grade options

Module can be ordered in commercial or in extended (from -25 C° to +85 C°) temperature grade.

## 1.2 Dimensions

Figure 1 shows main module dimensions from top view.

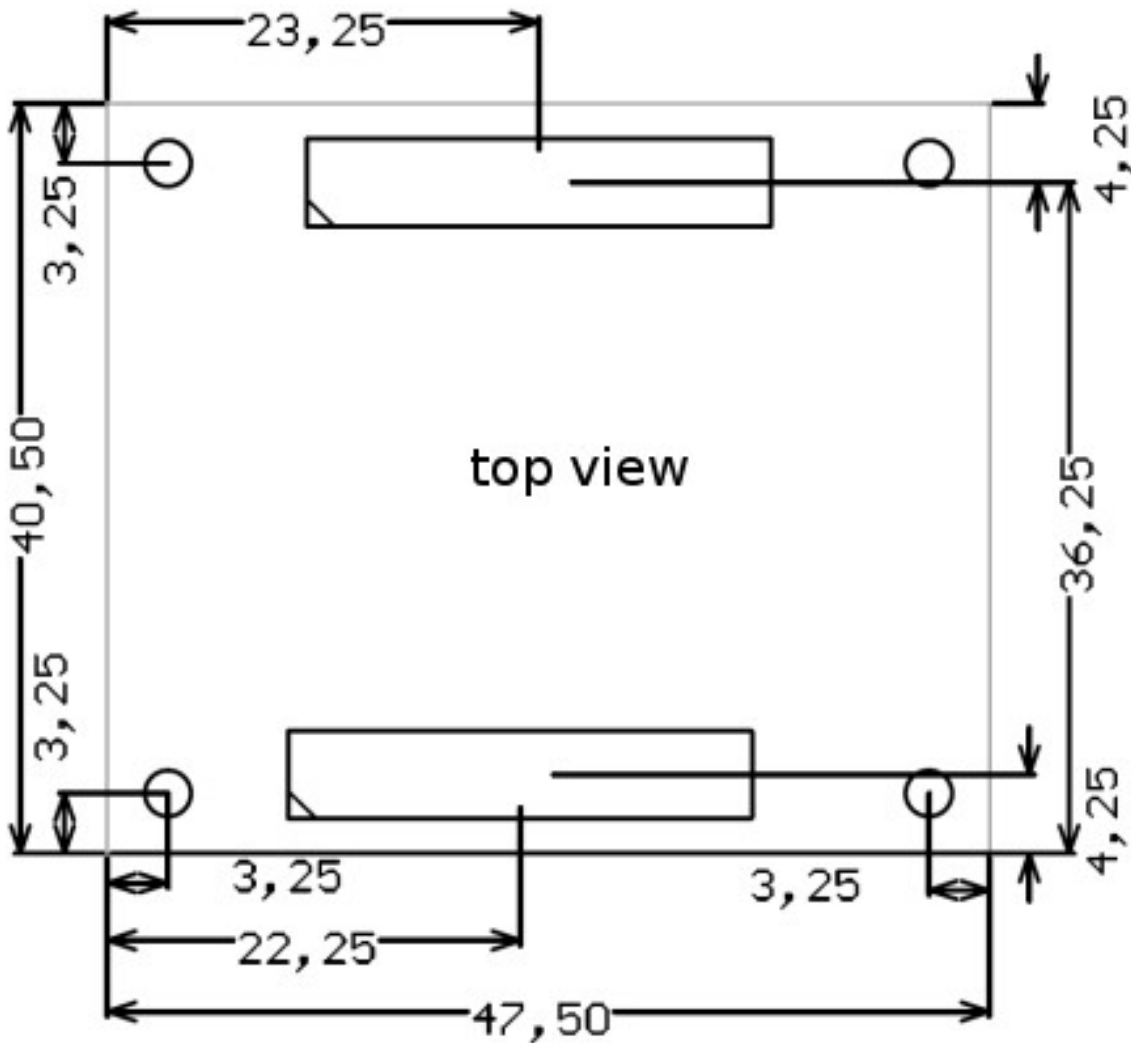

**Figure 1: Module dimensions in mm**

Mounting hole diameter is 3.2 mm.

<sup>1</sup> Contact Trenz Electronic support for availability

## 2 Detailed Description

### 2.1 Block Diagram

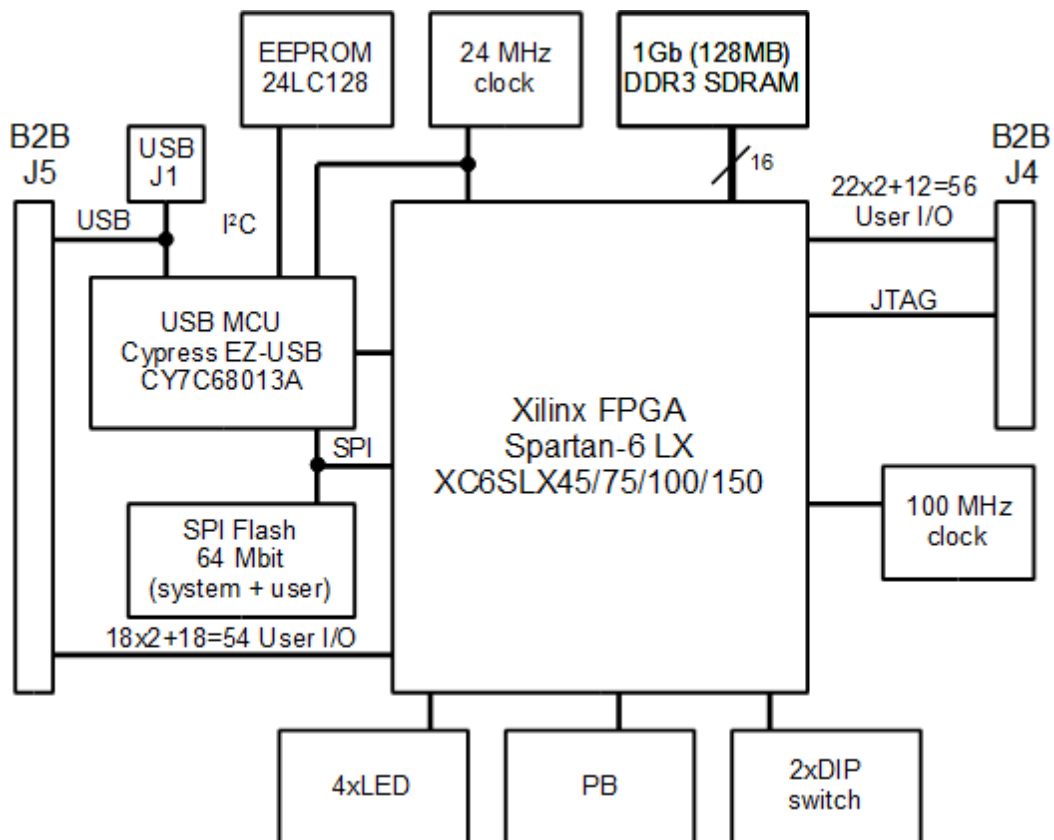

Figure 2: TE0630 block diagram

### 2.2 Power Supply

The module can be powered by B2B connector J5 or the USB connector. If both power supplies are available, the B2B connector power supply takes precedence, disabling the USB power supply automatically.

#### 2.2.1 Supply from B2B Connector

The B2B connector power supply requires a single nominal 5 V DC power supply. The power is usually supplied to the module through the 5 V contacts (5Vb2b) of B2B connector J5 (see chapter 6.4 J5 Pin-out). The recommended minimum supply voltage is 4 V. The maximum supply voltage is 5.5 V. The recommended maximum continuous supply current is 1.5 A.

#### 2.2.2 Supply from USB Connector

The module is powered by the USB connector if the following conditions are met:

- the module is equipped with an USB connector,
- the module is connected to a USB bus,

- no power supply is provided by B2B connectors.

In this case, other components (e.g. extension or carrier boards) may also be powered by the corresponding 5 volt line (5V) of B2B connector J5.

### 2.2.3 On-board Power Rails

Three on-board voltage regulators provide the following power supply rails needed by the components on the module:

- 1.2V, 3.0 A max
- 2.5V, 0.8 A max
- 3.3V, 3.0 A max
- 1.5V, 1.0 A max

Figure 3 show power supply diagram.

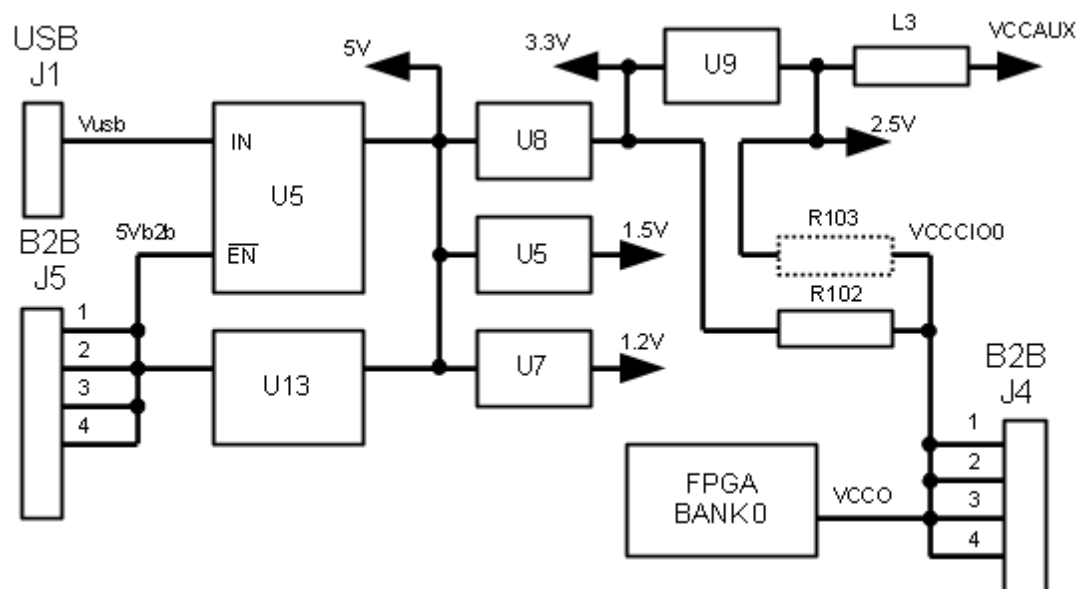

Figure 3: TE0630 Power diagram

The power rails are available for the FPGA and can be shared with a carrier board by the **corresponding** lines of the B2B connectors J4 and J5. Please note that the **power consumption of the FPGA is highly dependent on the design actually loaded**. So please use a tool like Xilinx Xpower to estimate the expected power consumption of your design.

Even if the provided voltages of the module are not used on the carrier board, it is recommended to bypass them to ground with 10 nF - 100 nF capacitors.

FPGA I/O banks power supply

Spartan-6 architecture organizes I/Os into four I/O banks, see Table 1 for supply voltage used for each bank.

VCCIO0 voltage can be configured in 3 ways:

- **2.5V** - When resistor **R103 is populated** and resistor **R102 is not populated**.
- **3.3V** - When **R103 is not populated** and resistor **R102 is populated**.



above the threshold voltage.

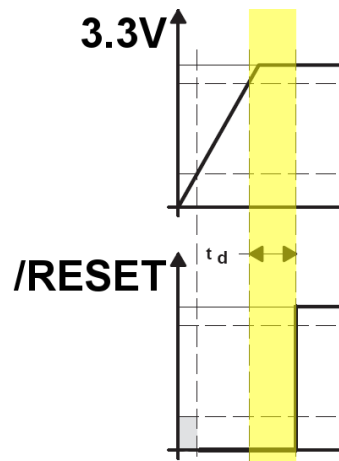

Figure 5: Reset on power-on

After this delay, the /RESET line is reset (high) and the FPGA configuration can start. When the supply rail voltage drops below the threshold voltage, the /RESET line becomes active (low) again and stays active (low) as long as the rail voltage remains below the threshold voltage (2.93 volt). Once the rail voltage raises again and remains over the threshold voltage for more than the typical delay time  $t_d$  of 200 ms, the /RESET line returns to the inactive state (high) to allow a new system start-up.

## 2.3 FPGA User I/Os

TE0630 provides user I/O signals connected to B2B connectors J4 and J5. There are 3 types of user I/O signals:

- Single ended;
- Differential pairs (each pair is configurable as 2 single-ended digital I/Os);
- Differential pairs, which can be used as clock inputs (each pair can be used as usual differential pair or 2 single-ended digital I/Os).

Table 2 show user I/O count for J4 and J5.

	J4	J5	Total
Single ended	12	18	30
Differential	18	16	34
Differential (clock)	4	2	6
Total	56	54	110

Table 2: User I/O count by connector

Table 3 show user I/O divided by VCCIO supply voltage.

	VCCIO0	3.3V	Total
Single ended	1	29	30
Differential	18	16	34
Differential (clock)	4	2	6
Total	45	65	110

Table 3: User I/O count by VCCIO



## 2.4 Board-to-board Connectors

The module has two B2B (board-to-board) receptacle connectors (J4 and J5) for a total of 160 contacts. Figure 6 shows B2B connectors location on board; USB connector is located on the top side and is shown to define module position.

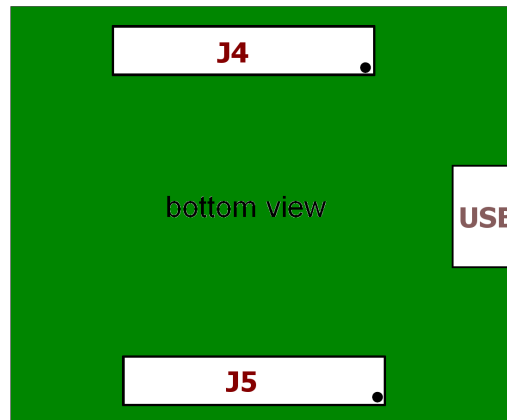

Figure 6: B2B connectors location

TE0630 uses high-density shockproof connectors shown in Figure 7. Connector part numbers are listed in Table 4.

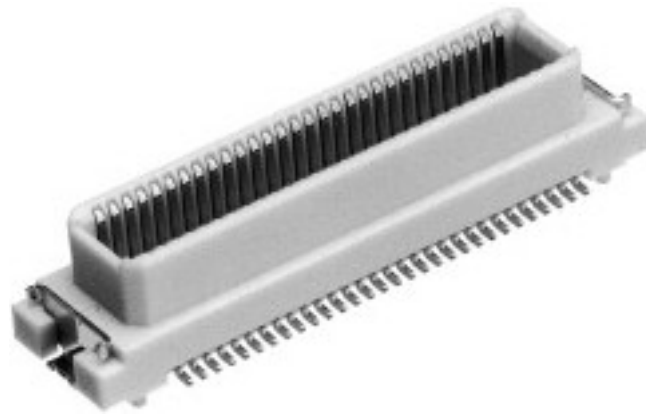

Figure 7: Module connector

Supplier	Header
Digikey	H11113CT-ND H11113TR-ND H11113DKR-ND
Hirose	DF17(3.0)-80DS-0.5V(57)
Trenz Electronic	22684

Table 4: Module connectors part numbers

The on-board receptacles mate with their corresponding headers on the carrier board shown in Figure 8. Ordering numbers of mating connectors are listed in Table 5.

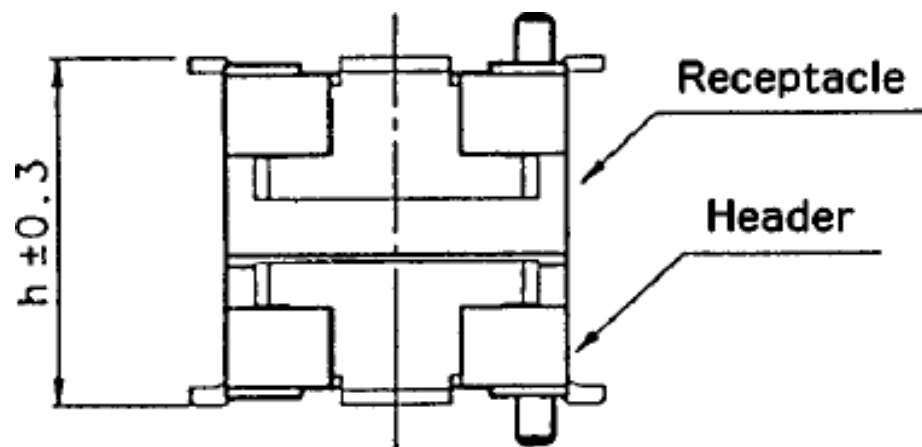

**Figure 8: Mating (carrier board) connector**

Supplier	Header
Digikey	H11148DKR-ND H11148TR-ND H11148CT-ND
Hirose	DF17(4.0)-80DP-0.5V(57)
Trenz Electronic	22938

**Table 5: Carrier board headers part numbers.**

Figure 9 shows the definition of stacking height featured by the combination of the TE0630 receptacle with its corresponding header.



**Figure 9: B2B stacking**

The stacking height of the TE0630 B2B connectors is 7 (seven) mm. The stacking height does not include the solder paste thickness.

## 2.5 USB Connector

The module uses a mini-USB (B type) receptacle connector.



Figure 10: Mini-USB connector

## 2.6 JTAG connector

The offset holes of header J2 allow a removable press fit of standard 0.100 inch header pins to connect flying leads without any soldering necessary. JTAG signals are available on the dedicated header J2 through a JTAG programmer with flying leads as described in Table 6.

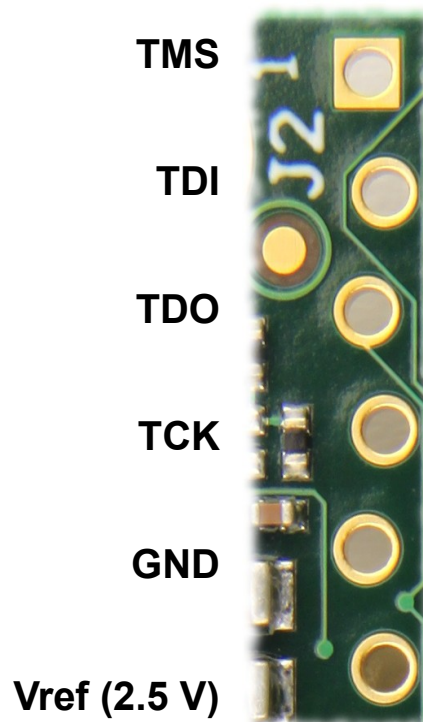

Table 6: JTAG header J2 pin-out

## 2.7 Serial EEPROM

TE0630 is equipped with a Micron Technology 24LC128 128 K I<sup>2</sup>C CMOS Serial EEPROM (U1). It is used for EZ-USB FX2 firmware, vendor ID and device ID storage. EEPROM is accessible through the EZ-USB FX2 microcontroller.

## 2.8 SPI Flash

TE0630 is equipped with a Winbond W25Q64BV 64 Mb (8 MB) serial flash memory chip (U14). This serial flash chip can operate as general SPI memory mode and in double or quad modes. Usage of dual and quad modes increase bandwidth up to 40 MB/s. For more information see [Winbond W25Q64BV product overview](#).

## 2.9 DDR3 SDRAM

TE0630 is equipped with a 1 Gb (128 MB) DDR3 SDRAM chip. DDR3 memory is connected to FPGA bank 1.

## 2.10 USB Controller

TE0630 is equipped with a Cypress EZ-USB FX2 controller to provide a high-speed USB 2.0 interface. The controller uses 4 interfaces (See chapter 2.1 Block Diagram):

- USB interface (to USB connector);
- I<sup>2</sup>C interface (to EEPROM);
- SPI interface (to FPGA and Flash);
- FIFO interface (to FPGA).

The I<sup>2</sup>C interface connects the USB controller to the EEPROM chip, which stores vendor ID and device ID. See chapter 2.14 DIP Switch for available options.

The SPI interface is used to communicate with the FPGA and to access the SPI serial Flash chip.

The FIFO interface provides a high-speed communication channel with the FPGA. The interface can transfer up to 48 MB/s burst rate. FPGA pin-out information can be found in Table 7.

Signal name	FPGA pin
FD0	J6
FD1	H8
FD2	H5
FD3	H6
FD4	G7
FD5	G8
FD6	F8
FD7	A3
24MHZ1	G3
PA0/INT0	D1
PA1/INT1	D2
PA2/SLOE	C1
PA3/WU	E4
PA4/FIFOADDR0	B1
PA5/FIFOADDR1	C3
PA6/PKTEND	B2
PA7/FLAGD/SLCS	A2
RDY1/SLWR	M3
RDY0/SLRD	M4
CTL2/FLAGC	E3
CTL1/FLAGB	E1
CTL0/FLAGA	F3
IFCLK	N4

**Table 7: USB controller interface: FPGA pin-out**

## 2.11 Clock Oscillators

Two clock oscillators are installed on the TE0630.

Clock oscillator U10 generates a 24 MHz clock signal for the FPGA and the USB controller. This clock signal is used for synchronous communication between FPGA and USB controller.

Clock oscillator U11 generates a 100 MHz<sup>3</sup> clock signal used as a main system clock in FPGA designs. See Table 8 for pin-out information.

Signal	Frequency	FPGA pin
24MHZ1	24 MHz	G3
SYSCLK	100 MHz	AA12

**Table 8: Clock signals pin-out**

## 2.12 LEDs

TE0630 is equipped with four active-high LEDs. See Table 9 for details.

<sup>3</sup> Oscillator frequency can be changed by user request. Contact Trenz Electronic for details.

Signal name	FPGA pin	LED
U_LED1	F1	D3
U_LED2	F2	D5
U_LED3	J4	D6
U_LED4	K8	D7

**Table 9: LEDs pin-out**

## 2.13 Push-Button

TE0630 module is equipped with one active-high push-button (signal is set to logical "1" when button is pressed). Table 10 show push-button connection details.

Signal name	FPGA pin	PB
PB	R7	S5

**Table 10: Push button pin-out**

## 2.14 DIP Switch

On-board 4xDIP switch S1 used for system and user settings.

Switch 1 (S1A) is used to connect the USB controller to the I<sup>2</sup>C serial EEPROM. When S1A is "ON", serial I<sup>2</sup>C EEPROM is connected to the USB controller, when switch is "OFF", the USB controller is disconnected from the EEPROM<sup>4</sup>. Turn S1A off when programming the USB EEPROM (storing the USB vendor ID and device ID). This will force the USB controller to provide its default vendor ID and device ID.

Switch 2 (S1B) is used to control DC-DC converters. When switch is "OFF", converters are controlled by the USB controller. When switch is "ON", converters are enabled regardless of USB controller actions. At start-up, the USB controller switches off 1.2V, 1.5V and 2.5V power rails and starts up the module in low-power mode. After enumeration, the USB controller firmware switches the 1.2V, 1.5V and 2.5V power rails on, if enough current is available from the USB bus.

Switches 3 (S1C) and 4 (S1D) can be used as user switches. Switches are active-low. Pull-up resistors should be defined in user constrains file (UCF) to use this switches in FPGA design. See Table 11 for details.

Signal name	FPGA pin	Switch
IO_L61_N_1	AB21	S1C
IO_L63_N_1	AA22	S1D

**Table 11: DIP switch pin-out**

## 2.15 Board revisions and assembly variants

To determine PCB revision and assembly variant from FPGA, TE0630 have dedicated user signals, which can be read by user core.

Board revision coded in 4 bits BR[3:0]

<sup>4</sup> Zero-resistor R90 (not populated by default) short this switch and connect EEPROM regardless of S1A position.

Signal name	FPGA pin
BR0	R19
BR1	V19
BR2	V20
BR3	T17

**Table 12: Board revision pins**

To define low (zero) level BR pin connected to ground rail, to define high (one) level BR pin left float (open). These pins should be configured with "pullup" option in user design.

See Table 12 for current list of board revisions.

BR3	BR2	BR1	BR0	
0	0	0	0	00 Initial revision

**Table 13: Board revisions**

Module assembly variant encoded using AV[3:0] pins.

Signal name	FPGA pin
AV0	Y20
AV1	R15
AV2	R16
AV3	R17

**Table 14: Assembly variants pins**

To define low (zero) level AV pin connected to ground rail through zero resistor, to define high (one) level AV pin left float (open). These pins should be configured with "pullup" option in user design.

Available module assembly variants listed in Table 15.

AV3	AV2	AV1	AV0	
0	0	0	0	Base assembly variant

**Table 15: Module assembly variants**

## 3 TE0300 compatibility

TE0630 module designed to be compatible with TE0300 board by main mechanical and electrical characteristics.

### 3.1 Mechanical compatibility

Both modules have the same board dimensions. TE0630 mount holes and B2B connectors locations are match with TE0300. See chapter 1.2 Dimensions for detailed information.

TE0300 and TE0630 uses same B2B connectors types. In chapter 2.4 Board-to-board Connectors you can find B2B connectors part numbers and main characteristics.

### 3.2 Electrical compatibility

TE0300 and TE0630 have similar power requirements and matched power input pins. User signals to B2B connectors routed as differential pairs and single

ended lines. Differences in pin types shown in Table 16, not listed signals have same or compatible<sup>5</sup> type.

Connector:Pin	TE0300 pin name	TE0300 Type	TE0630 pin name	TE0630 Type
J4:5	B3_L01_P	DIO	V3_IO_01	SIO
J4:7	B3_L01_N	DIO	V3_IO_02	SIO
J4:9	B3_L02_P	DIO	V3_IO_03	SIO
J4:11	B3_L02_N	DIO	V3_IO_04	SIO
J4:17	B0_L24_N	DIO	V0_IO_01	SIO
J4:19	B0_L24_P	DIO	V0_IO_01_N	DIO
J4:6	B3_L07_P	DIO	V3_IO_06	SIO
J4:8	B3_L07_N	DIO	V3_IO_07	SIO
J4:10	B3_L03_N	DIO	V3_IO_08	SIO
J4:12	B3_L03_P	DIO	V3_IO_09	SIO
J5:13	B3_L22_P	DIO	V3_IO_12	SIO
J5:15	B3_L22_N	DIO	V3_IO_13	SIO
J5:19	B3_L20_P	DIO	V3_IO_14	SIO
J5:21	B3_L20_N	DIO	V3_IO_15	SIO
J5:16	B3_L21_N	DIO	V3_IO_17	SIO
J5:18	B3_L21_P	DIO	V3_IO_18	SIO
J5:20	B3_L23_N	DIO	V3_IO_19	SIO
J5:22	B3_L23_P	DIO	V3_IO_20	SIO
J5:32	B2_L06_P	DIO	V3_IO_24	SIO
J5:34	B2_L06_N	DIO	V3_IO_25	SIO
J5:41	B2_GCLK13	CIO	V2_IO_02	SIO
J5:49	B2_GCLK_L13_N	CIO	V2_IO_24_P	DIO
J5:51	B2_GCLK_L13_P	CIO	V2_IO_24_N	DIO

**Table 16: TE0300 and TE0630 pin types differences.**

See Table 17 for pin types definitions.

Type colour code	Description
DIO	Unrestricted, general-purpose differential user-I/O pin.
SIO	Unrestricted, general-purpose user-I/O pin.
CIO	Unrestricted, general-purpose differential user-I/O pin. This pin also can be used as FPGA clock input.

**Table 17: TE0300 and TE0630 pin types**

Most user signals to B2B connectors routed from same FPGA banks. Differences shown in Table 18.

<sup>5</sup> Signals routed as differential pairs can be used as single ended.



Connector:Pin	TE0300 Bank	TE0630 Bank
J4:15	0	3
J4:36	0	3
J4:52	0	3
J5:33	2	3
J5:28	2	3
J5:30	2	3
J5:32	2	3
J5:34	2	3
J5:38	2	3
J5:40	3	2
J5:42	3	2
J5:50	3	2
J5:52	3	2

**Table 18: TE0300 and TE0630 user signals I/O banks differences.**

I/O Banks power supply for both modules shown in Table 19.

Bank	TE0300	TE0630
B0	VCCIO (1.2 V - 3.3 V)	VCCIO (1.2 V - 3.3 V)
B1	2.5 V	1.5 V
B2	3.3 V	3.3 V
B3	3.3 V	3.3 V

**Table 19: TE0300 and TE0630 FPGA I/O banks power supply.**

Bank 0 I/O supply voltage at both modules can be configured by user, see chapter 2.2.3 On-board Power Rails.

## 4 Module Configuration

Full module configuration cycle (for just assembled board) include steps:

1. Generic USB driver installation
2. USB microcontroller large EEPROM programming
3. EEPROM programming
4. Dedicated driver installation
5. SPI Flash configuration

**Steps 1-3** already performed at Trenz Electronic laboratory, and **not required** to perform by end user.

To work with TE0630 module using USB interface user should install dedicated USB driver, which provide API to work with main module functions, for complete instructions see chapter 5.2 Dedicated driver installation.

The FPGA on the TE0630 can be configured by SPI Flash or by JTAG connector.

### 4.1 JTAG FPGA Configuration

Programming using JTAG interface provide convenient and fast way to test FPGA project. FPGA configuration programmed this way is volatile and lost

after reset or power cycle.

## 4.2 SPI FPGA Configuration

The bit-stream for the FPGA is stored in the SPI Flash. To use this bit-stream source FPGA configuration option is set to "Master Serial/SPI". See 2.8 SPI Flash for additional information.

SPI Flash can be programmed in several ways:

- Direct programming by USB controller (usually done by Firmware Upgrade Tool).
- Indirect SPI programming via FPGA pins, controlled by JTAG (can be done using Xilinx iMPACT). See Appendix A. Indirect SPI Programming using iMPACT.
- Direct SPI programming by FPGA, using an SPI core (FPGA project should contain SPI interface core and software to work with it).

In SPI Flash mode, the FPGA's internal oscillator generates the configuration clock frequency. The FPGA provides this clock on its CCLK output pin, driving the PROM's Slave Clock input pin. The FPGA begins configuring using its lowest frequency setting. If so specified in the configuration bitstream, the FPGA increases the CCLK frequency to the specified setting for the remainder of the configuration process. The maximum frequency is specified using the ConfigRate bitstream generator option. The maximum frequency supported by the FPGA configuration logic depends on the timing for the SPI Flash device. For TE0630 SPI Flash PROM, use ConfigRate = 12 or lower.

This options are set graphically in Xilinx ISE Software Project Navigator by selecting the following:

- Generate Programming File > Process Properties > Configuration Options > Configuration Rate > 12 (or lower)

## 4.3 eFUSE programming

To program eFUSE at TE0630 module follow the steps below.

- Connect 2.5V power rail to 3.3V power rail. It can be done on B2B connector see 6 B2B Connectors Pin Descriptions. Or if module connected to baseboard, better to short power rails on baseboard.
- Program eFUSE using JTAG cable and iMPACT software.
- Disconnect 2.5V and 3.3V power rails.

## 4.4 EZ-USB FX2 Firmware Programming

TE0630 module supplied with already programmed FX2 firmware, so this procedure is **not needed for normal work flow**. This procedure is required only if custom firmware used or to restore firmware.

If the EEPROM has never been programmed before (virgin module) Switch 1 (S1A) can be switched to EEPROM (to "ON" state). See chapter 2.14 DIP Switch for details. The USB microcontroller will detect an empty EEPROM and

will provide its default vendor ID and device ID to the USB host. If the EEPROM has been programmed before (EEPROM not empty), S1A must be switched to "OFF". The USB microcontroller will detect a missing EEPROM and will provide its default vendor ID and device ID to the USB host.

## 4.5 EZ-USB FX2 EEPROM Programming

TE0630 module supplied with already programmed EEPROM, so this procedure is **not needed for normal work flow**. This procedure is required only if custom firmware used or to restore firmware.

First of all, check that Switch 1 (S1A) is actually switched to EEPROM. The USB EEPROM can be programmed by opening the dedicated software "Cypress USB Console" (double click the "CyConsole.exe" file in the "1st\_program\CyConsole" folder).

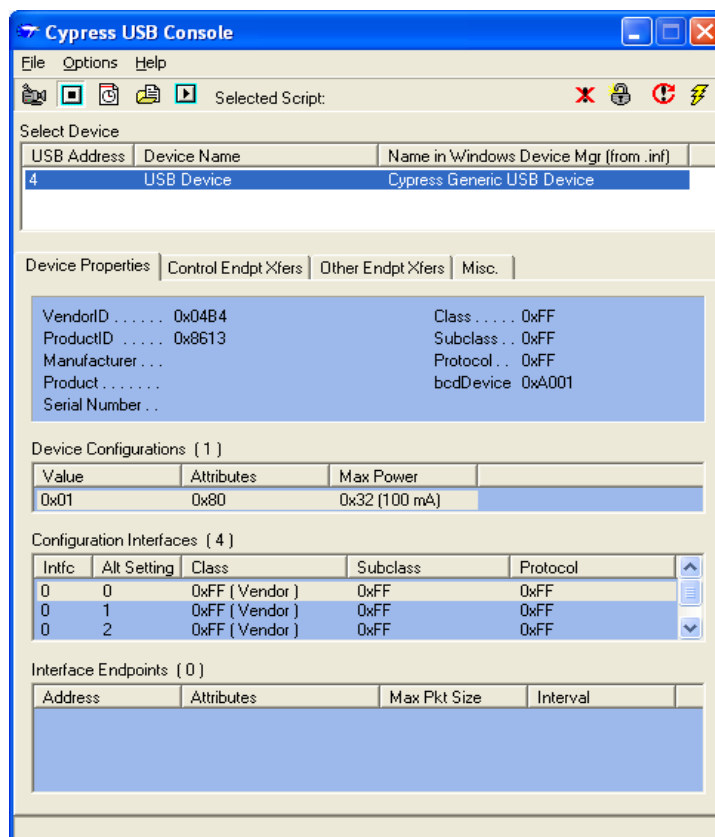

Click "Options > EZ-USB Interface" to Open EZ-USB Interface window.

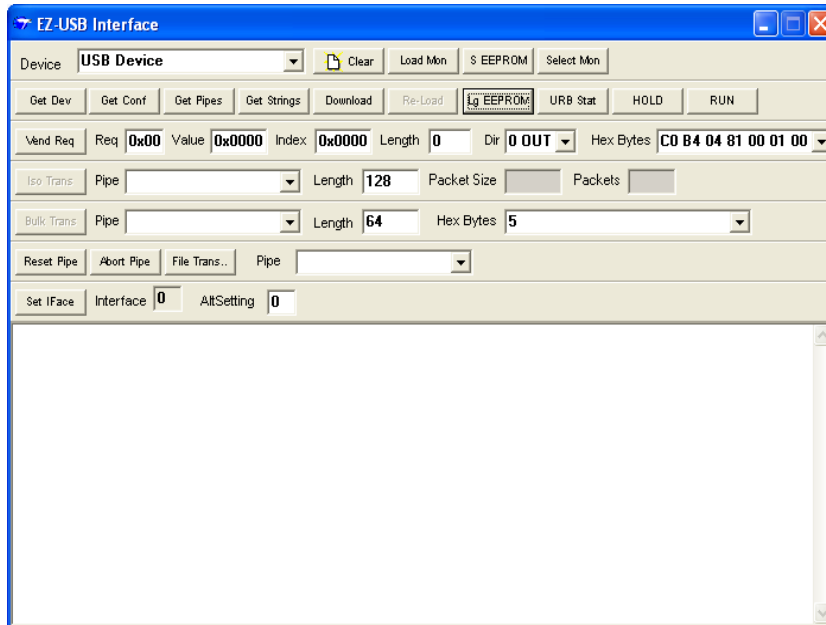

“S EEPROM” button refers to the small EEPROM (256 bytes) whereas the “Lg EEPROM” refers to the large EEPROM (64 KB). Press the “Lg EEPROM” button, select the “USB.iic” file and press the “Open” button to start writing to EEPROM.

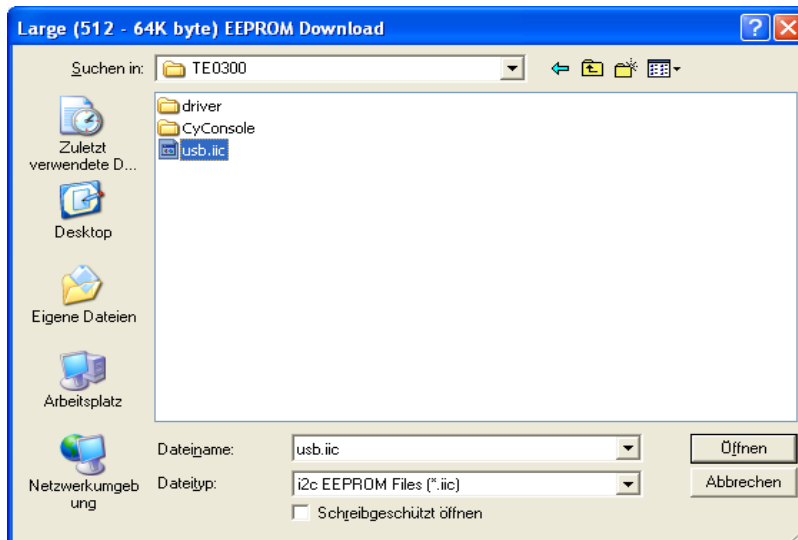

Upgrade progress is displayed in status window and is completed when “Download Successful” text is displayed.

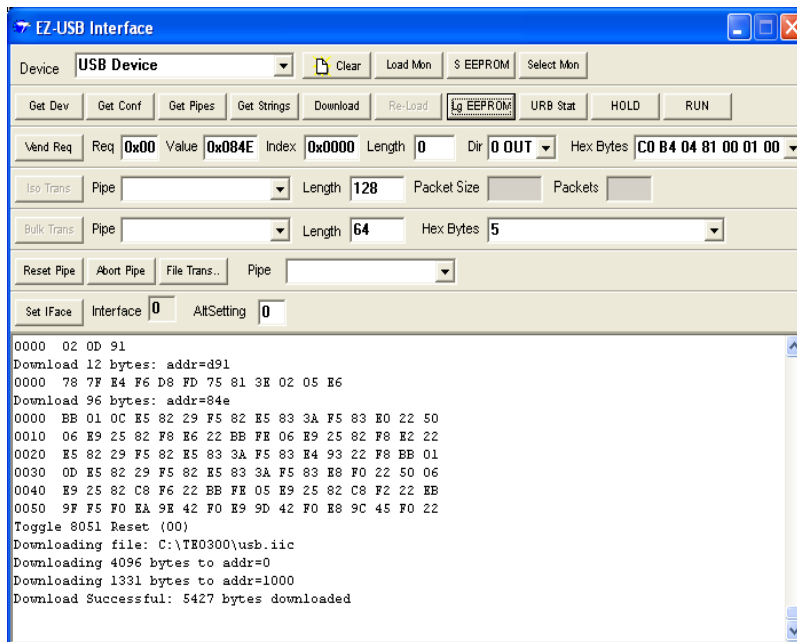

After that EEPROM will contain right VID/PID. To apply changes reconnect USB cable.

## 5 USB Drivers Installation

To provide convenient interface from host computer to TE0630 module, USB driver should be installed to operating system. There is 2 drivers to work with TE0630 module:

- Generic driver, which work with default controller configuration.
- Dedicated driver, which works with custom FX2 firmware.

**Generic driver** used only for initial USB microcontroller programming and **not needed for normal work flow**.

Most TE0630 users **need to install only dedicated driver** see chapter 5.2 Dedicated Driver.

### 5.1 Generic Driver

Most **users don't need this driver**, this driver used only for initial USB microcontroller programming, which was already done for all supplied TE0630 modules.

If the USB microcontroller (Cypress EZ-ESB FX2) driver is not installed on the host computer, then the easiest way to do it is the following:

- disconnect the module if it connected or leave the module unconnected;
- configure the module such that the USB microcontroller will provide its default vendor ID and device ID to the USB host (i.e. Switch 1 (S1A) = "OFF" -- see chapter 4.4 EZ-USB FX2 Firmware Programming);
- connect the module to the host computer through the USB interface;
- wait until the operating system detects new hardware and starts the

hardware assistant;

- put Switch 1 (S1A) to "ON" (EEPROM connected to USB microcontroller);
- answer the hardware assistant questions as shown in the following example.

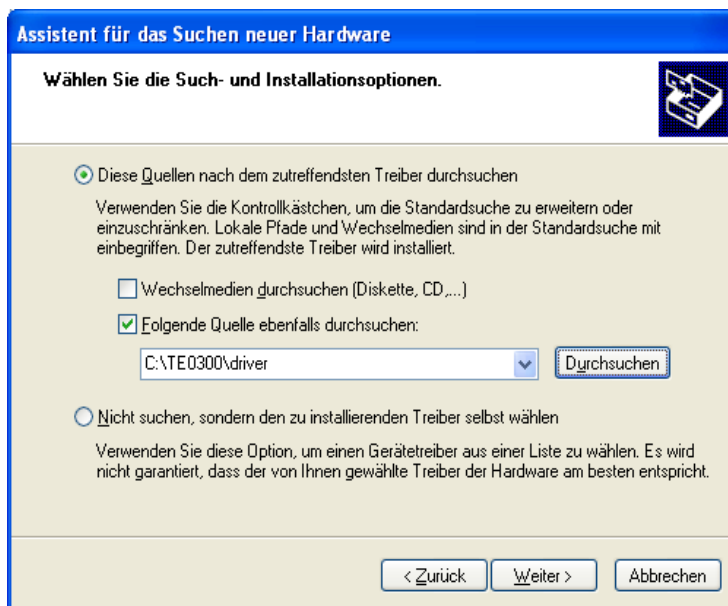
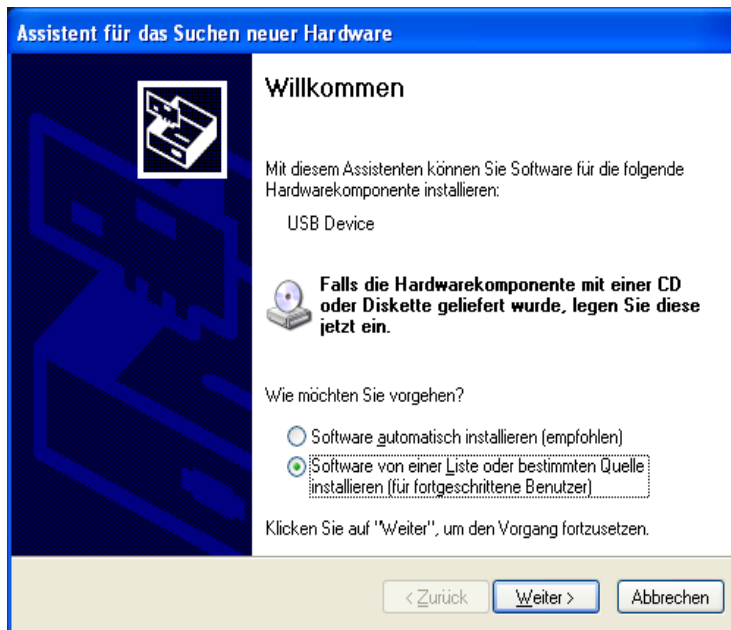

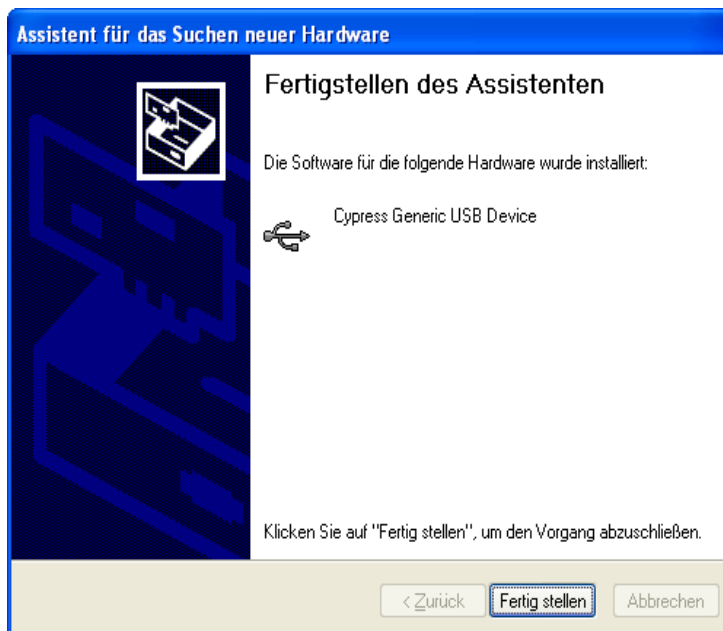
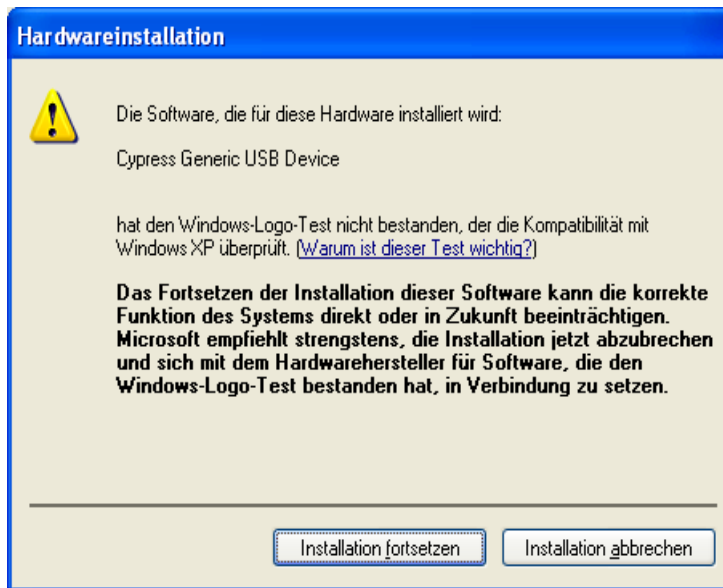

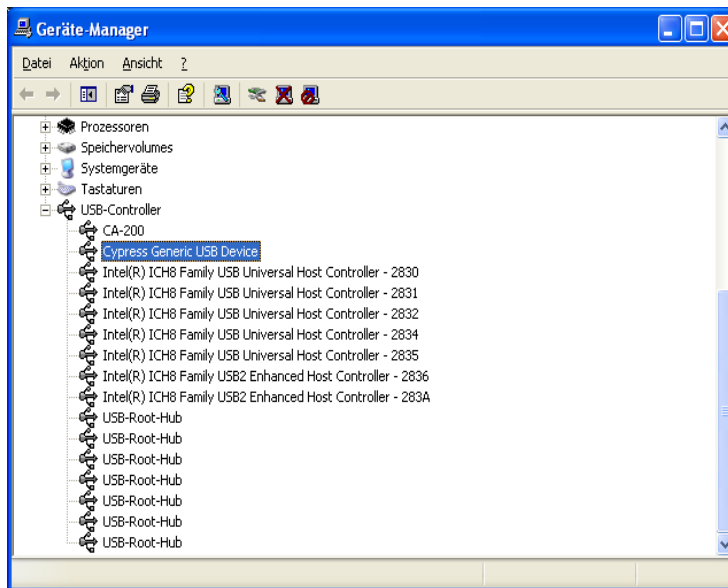

After that I<sup>2</sup>C EEPROM should be programmed with right Vendor ID / Device ID, see chapter 4.5 EZ-USB FX2 EEPROM Programming.

## 5.2 Dedicated Driver

This driver used to work with modules which have DEWESoft firmware and Vendor ID / Device ID programmed. All TE0630 modules supplied with programmed USB controller and corresponding Vendor ID / Device ID in EEPROM.

Before connect USB cable, check that Switch 1 (S1A) is on "ON" state (USB controller connected to EEPROM).

Connect USB cable and wait until the operating system detects new hardware and starts the hardware assistant and answer the hardware assistant questions as shown in the following example.



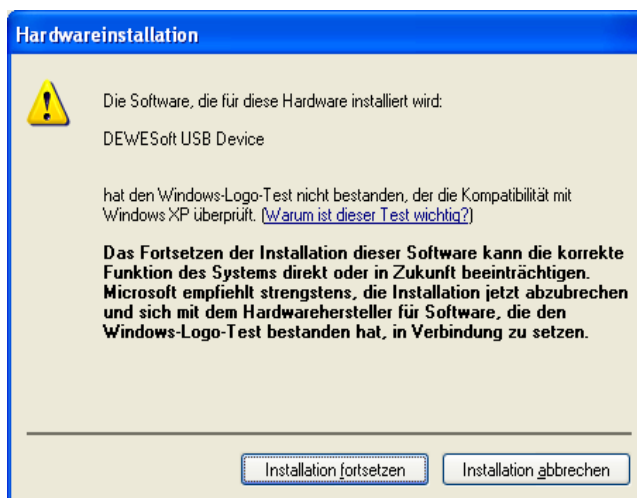
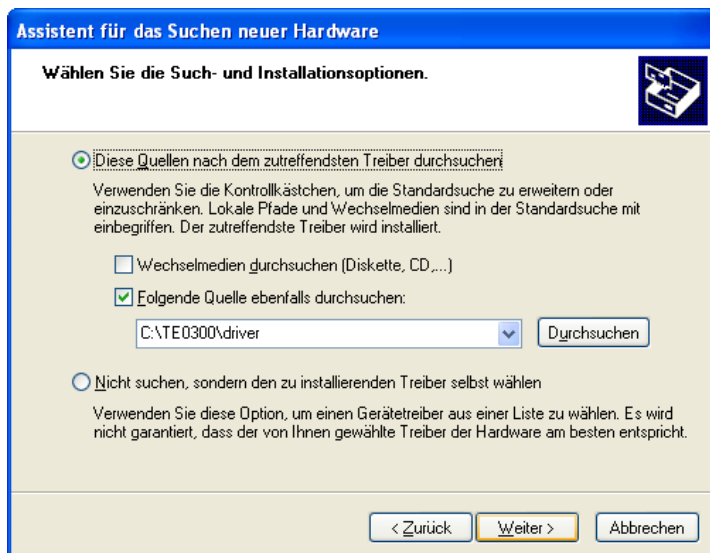
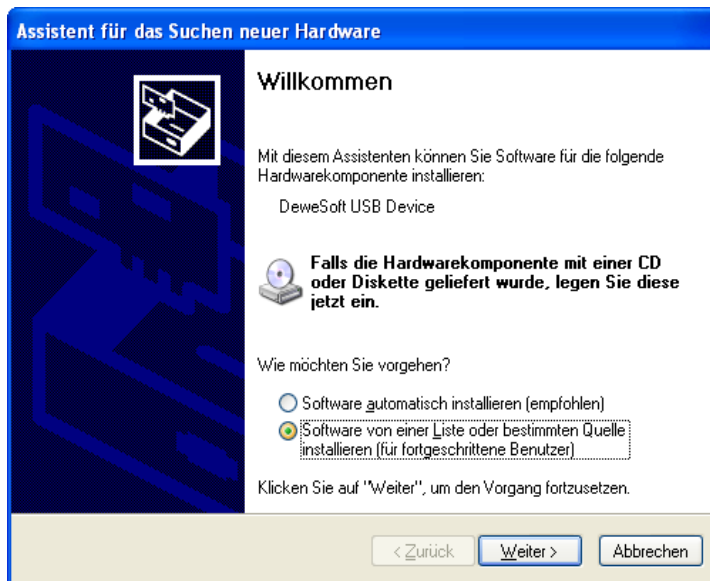



Check that in the “Device Manager” under “USB-Controller” the “DEWESoft USB Device 0” has been added.

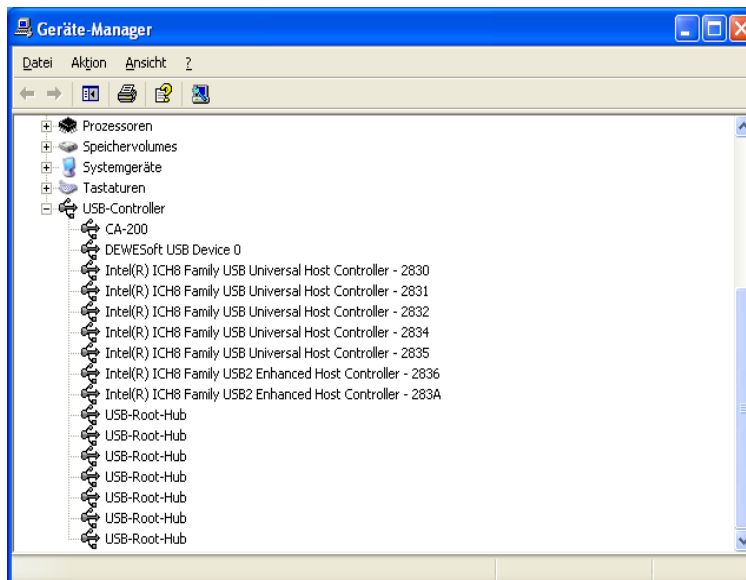

## 6 B2B Connectors Pin Descriptions

This section describes how the various pins on B2B connectors J4 and J5 are connected to TE0630 on-board components. There are four main signal types connected to B2B connectors:

- FPGA users signals;
- USB signals;
- Power signals;
- System reset signals.

## 6.1 Pin Labelling

FPGA user signals connected to B2B connectors are characterized by the "Vx\_IO\_yy\_p" naming convention, where:

- Vx defines the FPGA bank (x = bank number);
- IO defines an "FPGA to B2B" signal type;
- yy defines a differential pair or signal number (yy = pair number);
- p defines a differential signal polarity (P = positive, N = negative); single ended signals do not have this field.

Remaining signals use custom names.

## 6.2 Pin Types

Most pins of B2B connectors J1 and J2 are general-purpose, user-defined I/O pins (GPIOs). There are, however, up to 5 different functional types of pins on the TE0630, as outlined in Table 20. In pin-out tables Table 21 and Table 22, the individual pins are colour-coded according to pin type as defined in Table 20.

type colour code	description
DIO	Unrestricted, general-purpose differential user-I/O pin.
SIO	Unrestricted, general-purpose user-I/O pin.
CIO	Unrestricted, general-purpose differential user-I/O pin. This pin also can be used as FPGA clock input.
USB	USB signals.
JTAG	Dedicated JTAG signals.
GND	Dedicated ground pin. All must be connected.
SYS	System signal. See the description of each pin in the user manual for additional information on the corresponding signals.
POW	Power signals.

**Table 20: TE0630 pin types**

## 6.3 J4 Pin-out

J4 pin	Net	Type	FPGA pin	Net Length (mm)	J4 pin	Net	Type	FPGA pin	Net Length (mm)
1	VCCIO0	POW	-	-	2	VCCIO0	POW	-	-
3	VCCIO0	POW	-	-	4	VCCIO0	POW	-	-
5	V3_IO_01	SIO	G6	13.30	6	V3_IO_06	SIO	C4	15.26
7	V3_IO_02	SIO	G4	11.05	8	V3_IO_07	SIO	D3	17.04
9	V3_IO_03	SIO	F5	10.46	10	V3_IO_08	SIO	E6	14.97
11	V3_IO_04	SIO	E5	10.08	12	V3_IO_09	SIO	D5	13.84
13	GND	GND	-	-	14	GND	GND	-	-
15	V3_IO_05	SIO	F7	10.16	16	V0_IO_11_P	DIO	B6	12.29
17	V0_IO_01	SIO	A4	5.16	18	V0_IO_11_N	DIO	A6	10.84
19	V0_IO_01_N	DIO	A5	5.14	20	V0_IO_12_N	DIO	A7	10.95
21	V0_IO_01_P	DIO	C5	6.84	22	V0_IO_12_P	DIO	C7	12.30
23	GND	GND	-	-	24	GND	GND	-	-
25	V0_IO_02_N	DIO	C6	7.27	26	V0_IO_13_N	DIO	A8	10.41
27	V0_IO_02_P	DIO	D6	8.16	28	V0_IO_13_P	DIO	B8	11.74
29	V0_IO_03_P	DIO	D7	7.93	30	V0_IO_14_N	DIO	A9	10.40
31	V0_IO_03_N	DIO	C8	7.21	32	V0_IO_14_P	DIO	C9	12.81
33	3.3V	POW	-	-	34	3.3V	POW	-	-
35	V0_IO_04_P	DIO	D9	9.34	36	V3_IO_10	SIO	M7	21.84
37	V0_IO_04_N	DIO	D8	10.08	38	V0_CLK_04_N	CIO	C12	12.96
39	V0_CLK_03_P	CIO	B12	6.00	40	V0_CLK_04_P	CIO	D11	13.32
41	V0_CLK_03_N	CIO	A12	05.01	42	V0_CLK_01_N	CIO	A10	10.97
43	GND	GND	-	-	44	V0_CLK_01_P	CIO	B10	11.84
45	V0_CLK_02_P	CIO	C11	7.93	46	GND	GND	-	-
47	V0_CLK_02_N	CIO	A11	10.76	48	V0_IO_15_N	DIO	A15	11.79
49	V0_IO_05_P	DIO	C13	7.20	50	V0_IO_15_P	DIO	C15	13.66
51	V0_IO_05_N	DIO	A13	6.11	52	V3_IO_11	SIO	M8	26.06
53	2.5V	POW	-	-	54	2.5V	POW	-	-
55	V0_IO_06_P	DIO	D10	12.84	56	V0_IO_16_P	DIO	B16	12.98
57	V0_IO_06_N	DIO	C10	13.09	58	V0_IO_16_N	DIO	A16	10.96
59	V0_IO_07_P	DIO	F10	16.22	60	V0_IO_17_P	DIO	C17	16.33
61	V0_IO_07_N	DIO	E10	15.43	62	V0_IO_17_N	DIO	A17	13.51
63	GND	GND	-	-	64	GND	GND	-	-
65	V0_IO_08_N	DIO	A14	8.21	66	V0_IO_18_P	DIO	B18	15.19
67	V0_IO_08_P	DIO	B14	9.11	68	V0_IO_18_N	DIO	A18	13.77
69	V0_IO_09_N	DIO	C14	9.40	70	TDI	JTAG	E18	-
71	V0_IO_09_P	DIO	D15	9.40	72	TDO	JTAG	E14	-
73	1.2V	POW	-	-	74	1.2V	POW	-	-
75	V0_IO_10_N	DIO	C16	9.65	76	TCK	JTAG	D14	-
77	V0_IO_10_P	DIO	D17	9.58	78	TMS	JTAG	E16	-
79	GND	GND	-	-	80	GND	GND	-	-

Table 21: J4 connector pin-out

## 6.4 J5 Pin-out

J5 pin	Net	Type	FPGA pin	Net Length (mm)	J5 pin	Net	Type	FPGA pin	Net Length (mm)
1	5Vb2b	POW	-	-	2	5Vb2b	POW	-	-
3	5Vb2b	POW	-	-	4	5Vb2b	POW	-	-
5	5V	POW	-	-	6	/MR	SYS	-	-
7	B2B_D_P	USB	-	-	8	/RESET	SYS	-	-
9	B2B_D_N	USB	-	-	10	RESET	SYS	-	-
11	GND	GND	-	-	12	GND	GND	-	-
13	V3_IO_12	SIO	T2	19.97	14	V3_IO_16	SIO	U1	10.26
15	V3_IO_13	SIO	T1	18.91	16	V3_IO_17	SIO	U3	11.74
17	V2_IO_01	SIO	V15	18.18	18	V3_IO_18	SIO	V1	9.72
19	V3_IO_14	SIO	AA2	16.26	20	V3_IO_19	SIO	V2	10.03
21	V3_IO_15	SIO	AB2	15.23	22	V3_IO_20	SIO	Y1	9.21
23	GND	GND	-	-	24	GND	GND	-	-
25	V2_IO_01_N	DIO	AB6	10.68	26	V3_IO_21	SIO	Y2	8.73
27	V2_IO_01_P	DIO	AA6	12.54	28	V3_IO_22	SIO	AB3	6.68
29	V2_IO_02_P	DIO	Y7	13.32	30	V3_IO_23	SIO	Y3	8.38
31	V2_IO_02_N	DIO	AB7	11.56	32	V3_IO_24	SIO	AB4	6.65
33	V3_IO_27	SIO	U8	8.41	34	V3_IO_25	SIO	AA4	7.51
35	3.3V	POW	-	-	36	3.3V	POW	-	-
37	V2_IO_03_N	DIO	AB8	12.43	38	V3_IO_26	SIO	Y4	8.41
39	V2_IO_03_P	DIO	AA8	13.01	40	V2_IO_10_P	DIO	W6	9.20
41	V2_IO_02	SIO	AB12	12.62	42	V2_IO_10_N	DIO	Y6	8.31
43	GND	GND	-	-	44	GND	GND	-	-
45	V2_CLK_01_N	CIO	AB11	11.34	46	V2_IO_11_N	DIO	Y8	8.09
47	V2_CLK_01_P	CIO	Y11	12.64	48	V2_IO_11_P	DIO	W9	9.10
49	V2_IO_04_P	DIO	W15	14.63	50	V2_IO_12_P	DIO	Y9	8.40
51	V2_IO_04_N	DIO	Y16	12.42	52	V2_IO_12_N	DIO	AB9	6.60
53	2.5V	POW	-	-	54	2.5V	POW	-	-
55	V2_IO_05_N	DIO	U14	17.21	56	V2_CLK_02_N	CIO	AB10	7.26
57	V2_IO_05_P	DIO	T14	18.75	58	V2_CLK_02_P	CIO	AA10	8.16
59	V2_IO_06_P	DIO	AA14	12.39	60	V2_IO_13_P	DIO	W11	11.39
61	V2_IO_06_N	DIO	AB14	11.34	62	V2_IO_13_N	DIO	Y10	10.30
63	GND	GND	-	-	64	GND	GND	-	-
65	V2_IO_07_N	DIO	AB15	11.87	66	V2_IO_14_N	DIO	Y12	9.80
67	V2_IO_07_P	DIO	Y15	13.55	68	V2_IO_14_P	DIO	W12	10.80
69	V2_IO_08_P	DIO	AA16	12.61	70	V2_IO_15_P	DIO	Y13	10.20
71	V2_IO_08_N	DIO	AB16	11.72	72	V2_IO_15_N	DIO	AB13	8.40
73	1.2V	POW	-	-	74	1.2V	POW	-	-
75	V2_IO_09_N	DIO	AB18	11.91	76	V2_IO_16_N	DIO	Y14	9.72
77	V2_IO_09_P	DIO	AA18	12.57	78	V2_IO_16_P	DIO	W14	10.72
79	GND	GND	-	-	80	GND	GND	-	-

Table 22: J5 connector pin-out

## 6.5 Signal Integrity Considerations

Traces of differential signals pairs are routed symmetrically (as symmetric pairs).

Traces of differential signals pairs are NOT routed with equal length<sup>6</sup>. For applications where traces length has to be matched or timing differences have to be compensated, Table 21 and Table 22 list the trace length of I/O signal lines measured from FPGA balls to B2B connector pins.

Traces of differential signals pairs are routed with a differential impedance between the two traces of 100 ohm. Single ended traces are routed with 60 ohm impedance.

An electronic version of these pin-out tables are available for download from the Trenz Electronic support area of the web site.

## 7 Related Materials and References

The following documents provide supplementary information useful with this user manual.

### 7.1 Data Sheets

- Winbond W25Q64BV product overview.  
<http://www.winbond.com.tw/hq/enu/ProductAndSales/ProductLines/FlashMemory/SerialFlash/W25Q64BV.htm>
- Xilinx DS160: Xilinx Spartan-6 Family overview  
[http://www.xilinx.com/support/documentation/data\\_sheets/ds160.pdf](http://www.xilinx.com/support/documentation/data_sheets/ds160.pdf)
- Cypress EZ-USB FX2 Controller datasheet  
<http://www.cypress.com/?mpn=CY7C68013A-56LTXC>

### 7.2 User Guides

- Xilinx UG380: Spartan-6 FPGA Configuration User Guide  
[http://www.xilinx.com/support/documentation/user\\_guides/ug380.pdf](http://www.xilinx.com/support/documentation/user_guides/ug380.pdf)
- Xilinx UG381: Spartan-6 FPGA SelectIO Resources  
[http://www.xilinx.com/support/documentation/user\\_guides/ug381.pdf](http://www.xilinx.com/support/documentation/user_guides/ug381.pdf)

## 8 Glossary of Abbreviations and Acronyms



A WARNING notice denotes a hazard. It calls attention to an operating procedure, practice, or the like that, if not correctly performed or adhered to, could result in damage to the product or loss of important data. Do not proceed beyond a WARNING notice until the indicated conditions are fully understood and met.

<sup>6</sup> Difference in signal lines length is negligible for used signal frequency.



A CAUTION notice denotes a risk. It calls attention to an operating procedure, practice, or the like that, if not correctly performed or adhered to, could result in a fault. (undesired condition that can lead to an error) Do not proceed beyond a CAUTION notice until the indicated conditions are fully understood and met.

<b>API</b>	application programming interface
<b>B2B</b>	board-to-board
<b>DSP</b>	digital signal processing; digital signal processor
<b>EDK</b>	Embedded Development Kit
<b>IOB</b>	input / output blocks; I/O blocks
<b>IP</b>	intellectual property
<b>ISP</b>	In-System Programmability
<b>PB</b>	push button
<b>SDK</b>	Software Development Kit
<b>TE</b>	Trenz Electronic
<b>XPS</b>	Xilinx Platform Studio

## 9 Legal Notices

### 9.1 Document Warranty

The material contained in this document is provided “as is” and is subject to being changed at any time without notice. Trenz Electronic does not warrant the accuracy and completeness of the materials in this document. Further, to the maximum extent permitted by applicable law, Trenz Electronic disclaims all warranties, either express or implied, with regard to this document and any information contained herein, including but not limited to the implied warranties of merchantability, fitness for a particular purpose or non infringement of intellectual property. Trenz Electronic shall not be liable for errors or for incidental or consequential damages in connection with the furnishing, use, or performance of this document or of any information contained herein.

### 9.2 Limitation of Liability

In no event will Trenz Electronic, its suppliers, or other third parties mentioned in this document be liable for any damages whatsoever (including, without limitation, those resulting from lost profits, lost data or business interruption) arising out of the use, inability to use, or the results of use of this document, any documents linked to this document, or the materials or information contained at any or all such documents. If your use of the materials or information from this document results in the need for servicing, repair or correction of equipment or data, you assume all costs thereof.

### 9.3 Copyright Notice

No part of this manual may be reproduced in any form or by any means (including electronic storage and retrieval or translation into a foreign language) without prior agreement and written consent from Trenz Electronic.

## **9.4 Technology Licenses**

The hardware / firmware / software described in this document are furnished under a license and may be used /modified / copied only in accordance with the terms of such license.



## 10 Environmental Protection

---

To confront directly with the responsibility toward the environment, the global community and eventually also oneself. Such a resolution should be integral part not only of everybody's life. Also enterprises shall be conscious of their social responsibility and contribute to the preservation of our common living space. That is why Trenz Electronic invests in the protection of our Environment.

### **10.1 REACH (Registration, Evaluation, Authorisation and Restriction of Chemicals) Compliance Statement**

Trenz Electronic is a manufacturer and a distributor of electronic products. It is therefore a so called downstream user in the sense of **REACH**. The products we supply to you are solely non-chemical products (goods). Moreover and under normal and reasonably foreseeable circumstances of application, the goods supplied to you shall not release any substance. For that, Trenz Electronic is obliged to neither register nor to provide safety data sheet.

According to present knowledge and to best of our knowledge, no **SVHC (Substances of Very High Concern) on the Candidate List** are contained in our products.

Furthermore, we will immediately and unsolicited inform our customers in compliance with REACH - Article 33 if any substance present in our goods (above a concentration of 0,1 % weight by weight) will be classified as SVHC by the **European Chemicals Agency (ECHA)**.

### **10.2 RoHS (Restriction of Hazardous Substances) compliance statement**

Trenz Electronic GmbH herewith declares that all its products are developed, manufactured and distributed RoHS compliant.

### **10.3 WEEE (Waste Electrical and Electronic Equipment)**

Information for users within the European Union in accordance with Directive 2002/96/EC of the European Parliament and of the Council of 27 January 2003 on waste electrical and electronic equipment (WEEE).

Users of electrical and electronic equipment in private households are required not to dispose of waste electrical and electronic equipment as unsorted municipal waste and to collect such waste electrical and electronic equipment separately. By the 13 August 2005, Member States shall have ensured that systems are set up allowing final holders and distributors to return waste electrical and electronic equipment at least free of charge. Member States shall ensure the availability and accessibility of the necessary collection facilities. Separate collection is the precondition to ensure specific treatment and recycling of waste electrical and electronic equipment and is necessary to achieve the chosen level of protection of human health and the environment in the European Union. Consumers have to actively contribute to the success of such collection and the return of waste electrical and electronic equipment.

Presence of hazardous substances in electrical and electronic equipment results in potential effects on the environment and human health. The symbol consisting of the crossed-out wheeled bin indicates separate collection for waste electrical and electronic equipment.



## Appendix A. Indirect SPI Programming using iMPACT

To indirect program SPI Flash using Xilinx iMPACT do following steps:

Connect JTAG cable to corresponding module connector (see 2.6 JTAG connector).

Connect JTAG cable to host computer with installed Xilinx iMPACT software.

Power-on module by external power supply source or by USB cable.

Run Xilinx iMPACT.

Select Boundary Scan mode.

After initialization iMPACT window should look like

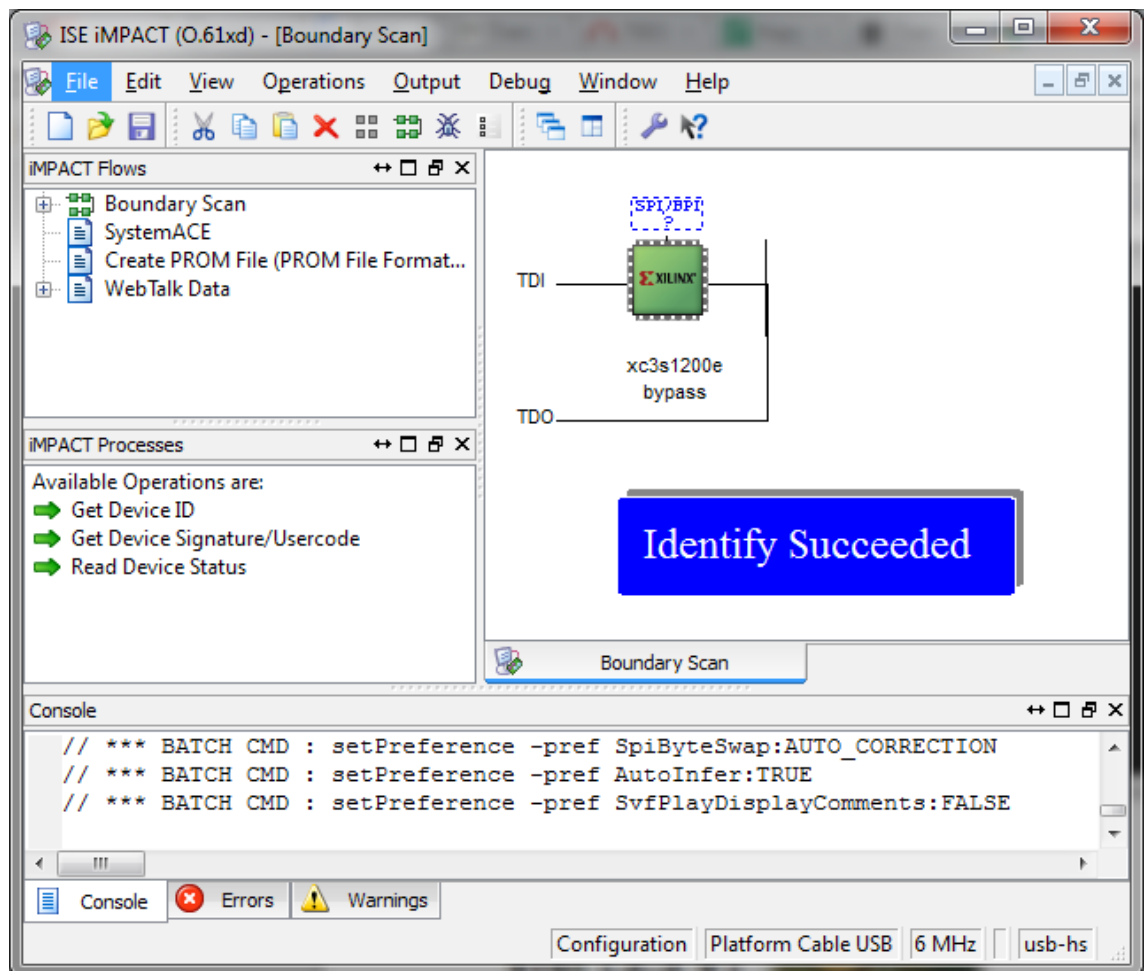

Right click on FPGA image and select “Add SPI/BPI Flash...” from menu.

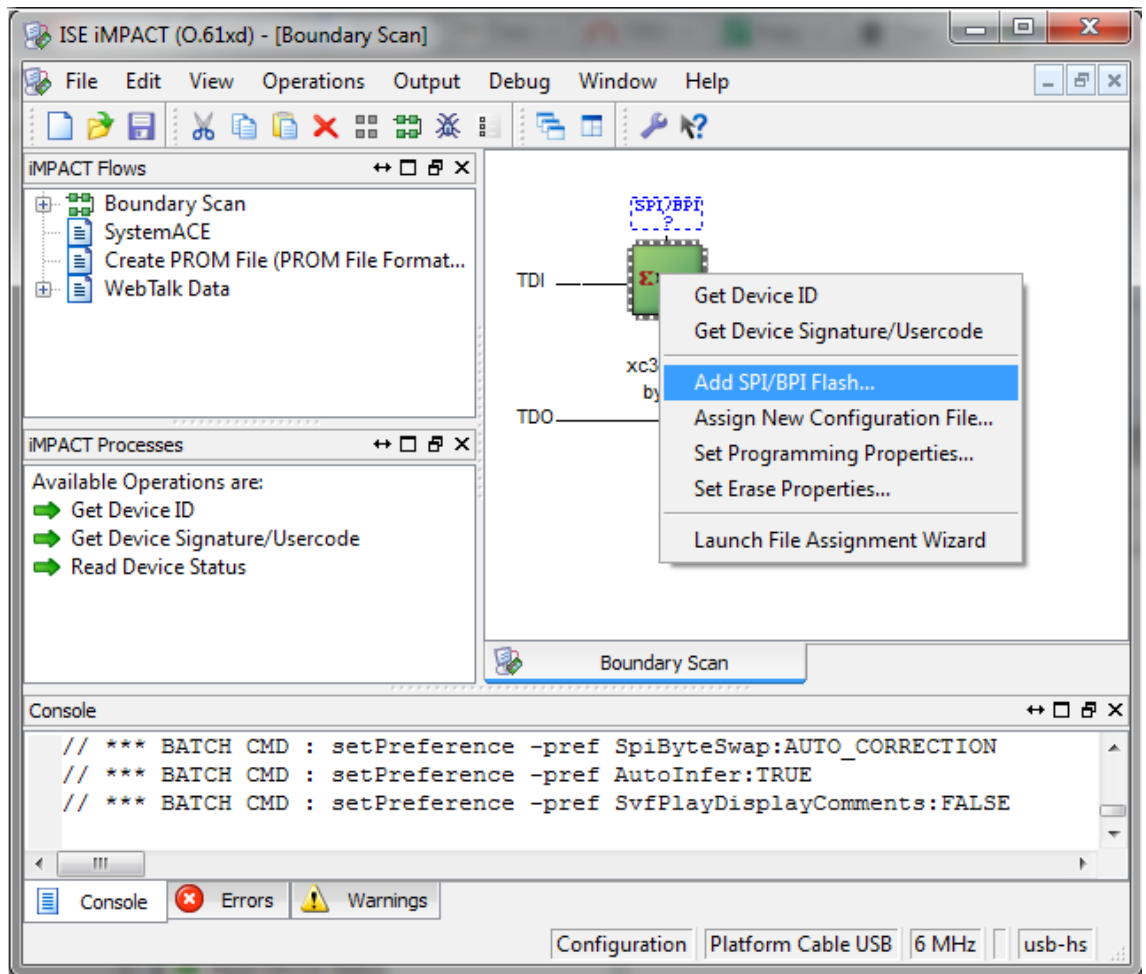

Select mcs file to program.

Select SPI Flash type corresponding to your module type and revision.

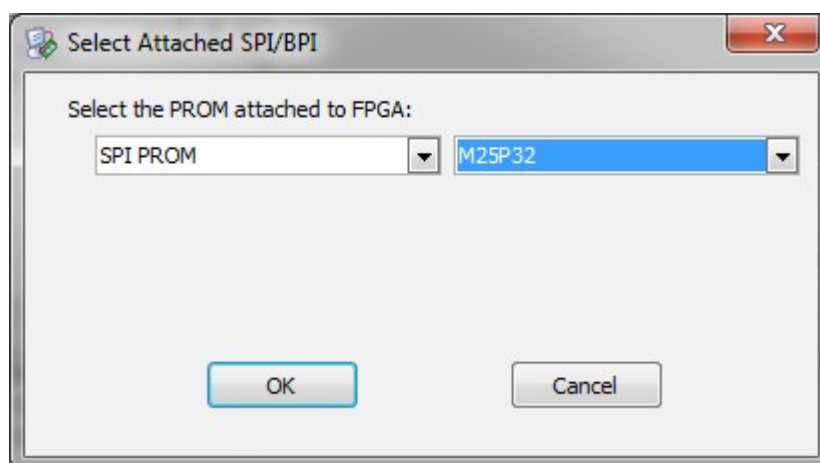

Right click on Flash image and select "Program" from menu.

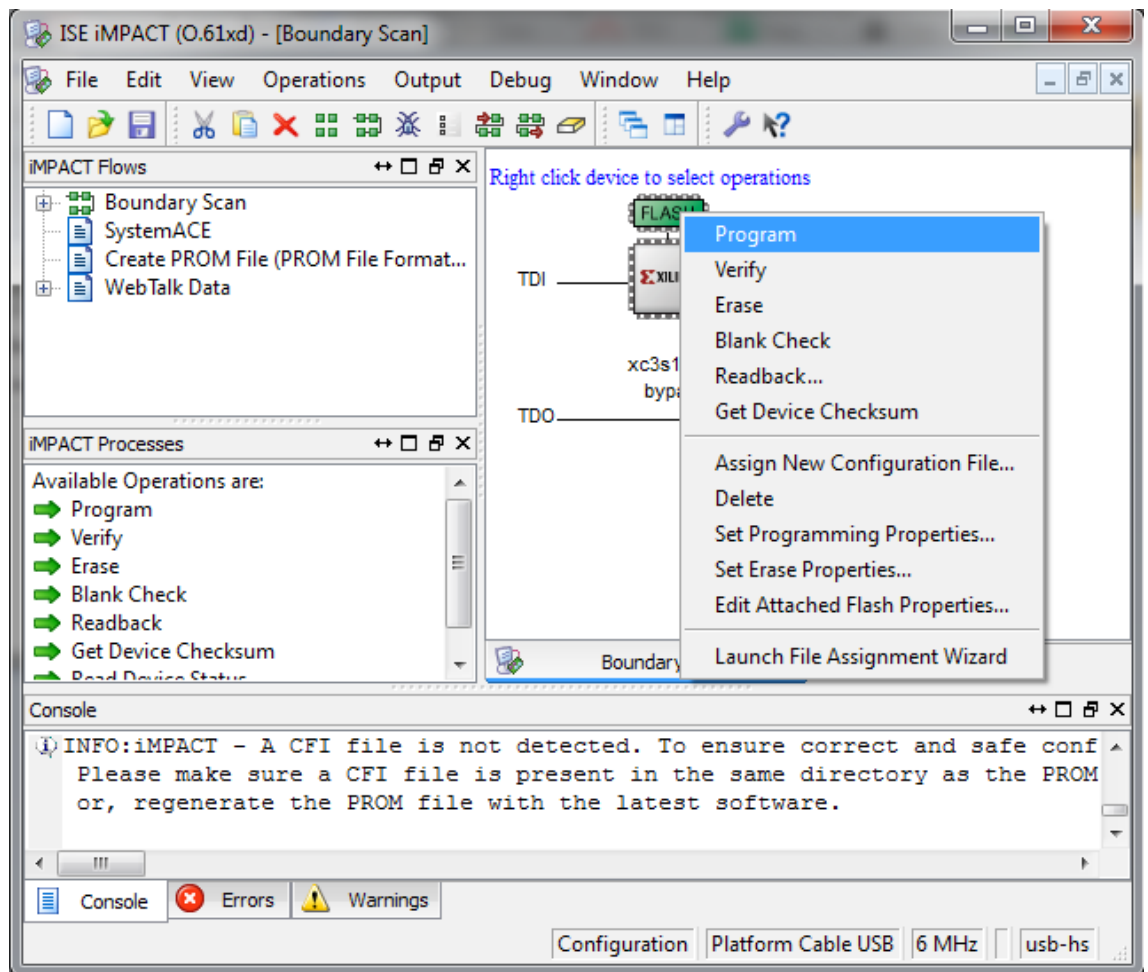

Leave default programming properties and press “OK”.

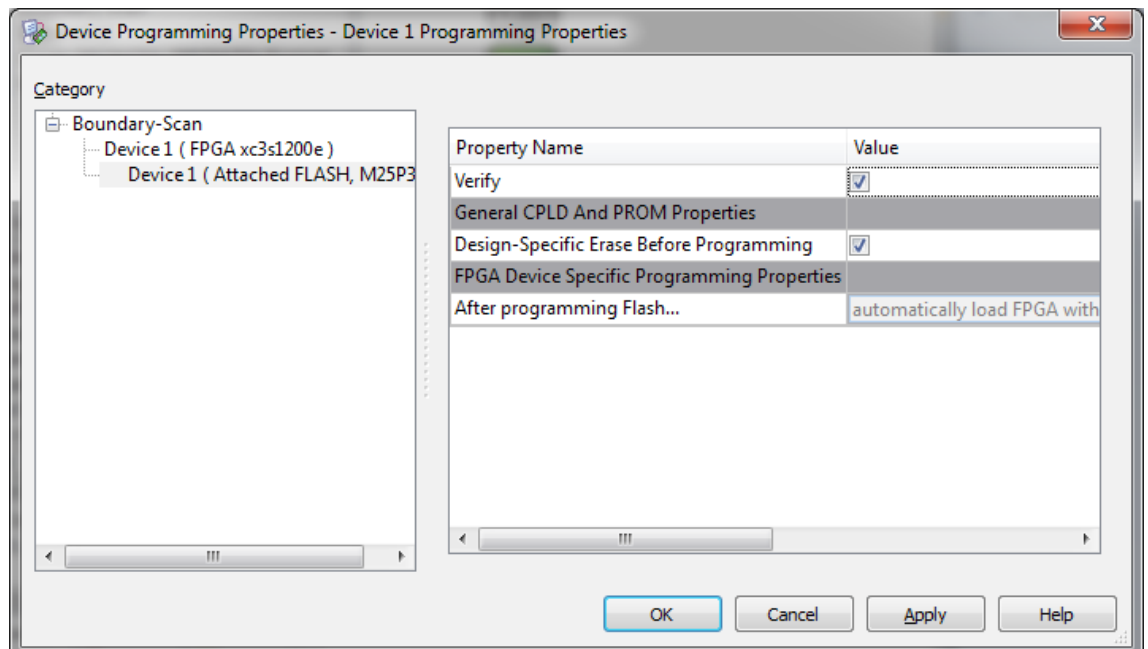

Wait for operation to complete.

After completion iMPACT window should show “Program Succeeded” sign.

