



UM11491

TEA2206DB1583 active bridge rectifier controller demo board

Rev. 1 — 2 December 2020

User manual

Document information

Information	Content
Keywords	TEA2206T, TEA2206DB1583, active bridge rectifier controller, X-capacitor discharge, self-supplying, high efficiency, traditional diode bridge, power supply, demo board
Abstract	<p>This user manual describes how the TEA2206DB1583 demo board can be used to replace the traditional diode bridge. This demo board contains a TEA2206T, and two low-ohmic high-voltage MOSFETs, and four diodes for the high-side rectifier.</p> <p>The TEA2206T is an active bridge rectifier controller replacing the two low-side diodes in the traditional diode bridge with MOSFETs. Using the TEA2206T with low-ohmic high-voltage external MOSFETs significantly improves the efficiency of the power converter as the typical rectifier diode-forward conduction losses are eliminated. In addition, TEA2206T includes an X-capacitor discharge function to reduce power consumption at standby condition.</p>





Revision history

Rev	Date	Description
v.1	20201202	Initial version

1 Introduction

Note: This product has not undergone formal EU EMC assessment. As a component used in a research environment, it is the responsibility of the user to ensure that the finished assembly does not cause undue interference when used. It cannot be CE marked unless assessed.

WARNING	
<p>Lethal voltage and fire ignition hazard</p> <div style="display: flex; justify-content: space-around; align-items: center;">   </div>	<p>The non-insulated high voltages that are present when operating this product, constitute a risk of electric shock, personal injury, death and/or ignition of fire. This product is intended for evaluation purposes only. It shall be operated in a designated test area by personnel qualified according to local requirements and labor laws to work with non-insulated mains voltages and high-voltage circuits. This product shall never be operated unattended.</p>

This user manual describes the TEA2206DB1583 demo board. It provides a functional description, supported with instructions on how to connect the board to obtain the best results and performance.

The TEA2206T is a product of a new generation of active bridge rectifier controllers replacing the two low-side diodes in the traditional diode bridge with MOSFETs.

Using the TEA2206T with low-ohmic high-voltage external MOSFETs significantly improves the efficiency of the power converter as the typical rectifier diode-forward conduction losses are eliminated. Efficiency can improve up to about 0.7 % at 90 V (AC) mains voltage.

The TEA2206T is intended for power supplies with a boost-type power-factor controller as a first stage. The second stage can be a resonant controller, a flyback controller, or any other controller topology. It can be used in all power supplies requiring high efficiency such as adapters, server and telecom power supplies, desktop PCs, all-in-all PC power supplies, and television power supplies.

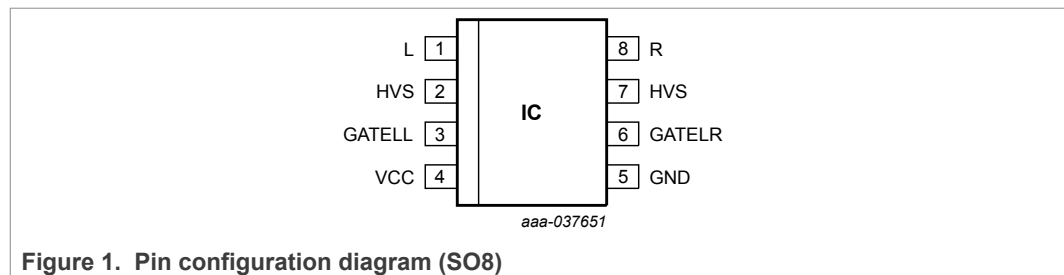

Figure 1. Pin configuration diagram (SO8)

1.1 Features

- Elimination of forward conduction losses of the diode rectifier bridge
- Very low IC power consumption (2 mW)
- Directly drives two rectifier MOSFETs
- Very low external part count
- Integrated X-capacitor discharge (2 mA)
- Self-supplying
- Undervoltage lockout (UVLO) for high-side and low-side drivers

- Drain-source overvoltage protection for all external power MOSFETs
- Gate pull-down currents at start-up for all external power MOSFETs

2 Safety warning

This demo board is connected to the mains voltage. Avoid touching the board while it is connected to the mains voltage and when it is in operation. An isolated housing is obligatory when used in uncontrolled, non-laboratory environments. Galvanic isolation from the mains phase using a fixed or variable transformer is always recommended.

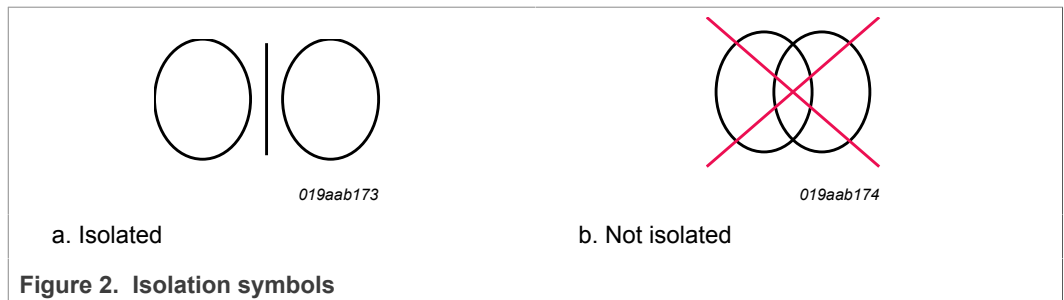

3 Board photographs

The TEA2206DB1583 demo board consists of the TEA2206T in an SO8 package with two MOSFETs (600 V; 28 mΩ) and four diodes (600 V; 20 A). [Figure 3](#) shows the front side of demo board.

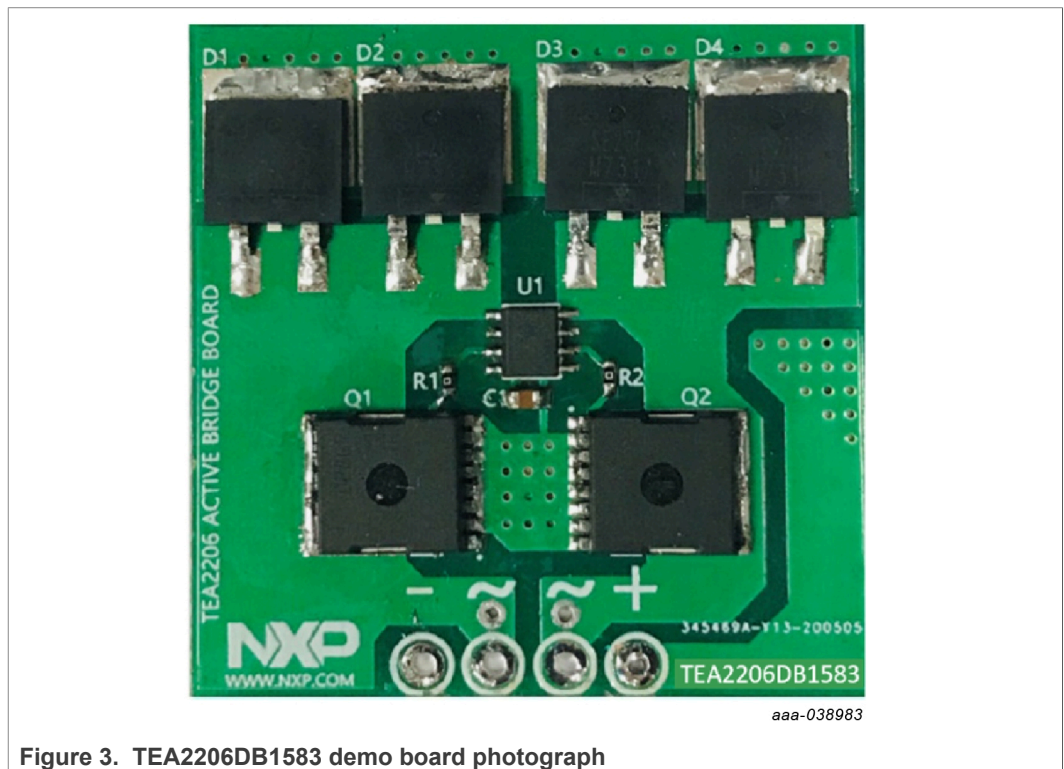

4 TEA2206DB1583 demo board setup

The TEA2206DB1583 demo board contains two 600 V, 28 mΩ MOSFETs and four 600 V, 20 A diodes. It makes the board suitable for universal AC input and output power applications of several hundreds of watts. The TEA2206DB1583 demo board contains four leads that can easily replace a traditional diode bridge. The inner two leads are connected to AC mains lines. The outer two leads are connected to positive and negative rectified voltages. These four leads are pin-to-pin with typical bridge-rectifier diodes pins. [Figure 4](#) describes the difference between bridge diodes and active bridge configurations.

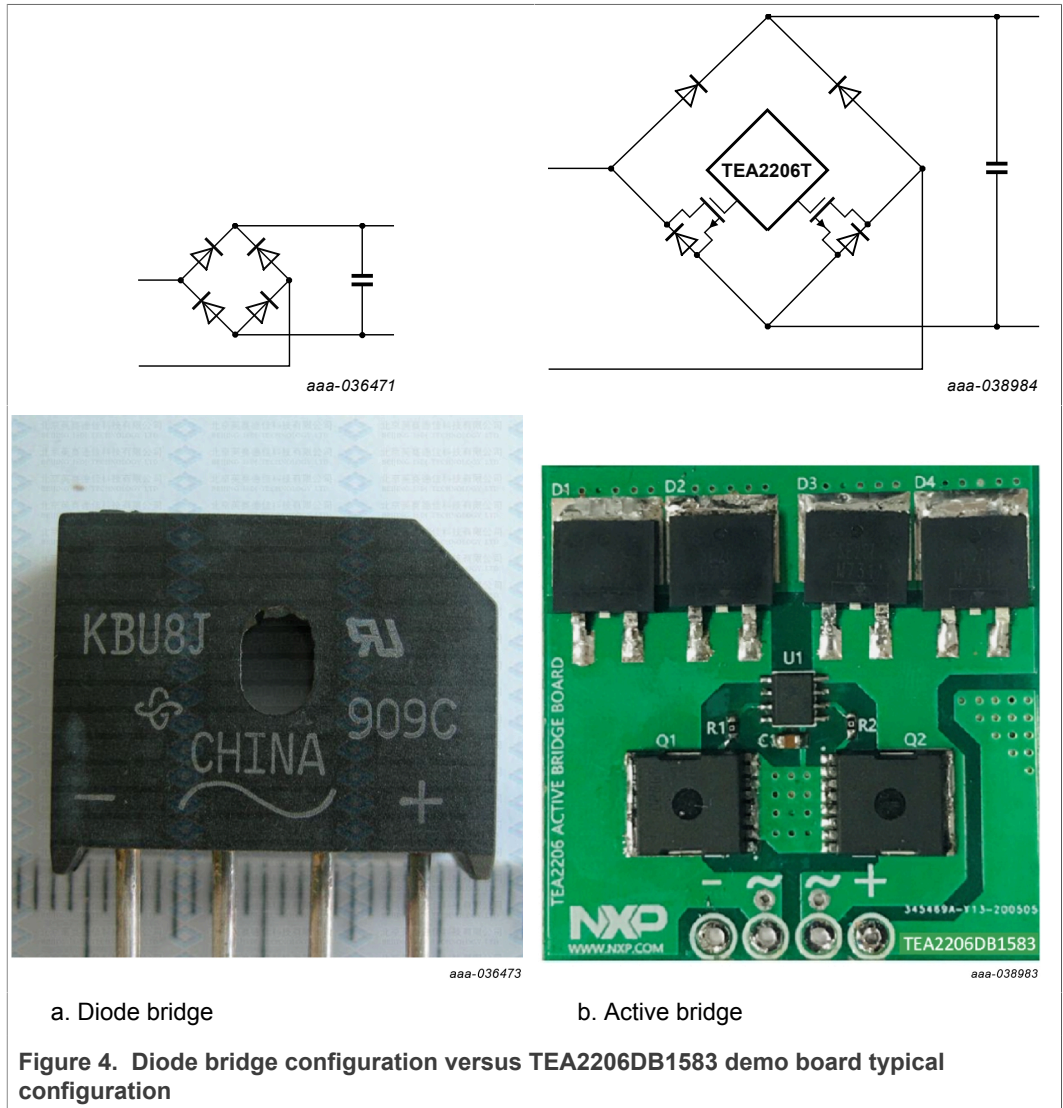

TEA2206DB1583 active bridge rectifier controller demo board

Figure 5 shows an example of the TEA2206DB1583 demo board mounted on an NXP Semiconductors TEA2016DB1519 demo board.



Figure 5. TEA2206DB1583 demo board added to 240 W resonant adapter board

5 Operation

The TEA2206T is a controller IC for an active bridge rectifier. It can directly drive the low-side two MOSFETs in an active bridge. [Figure 6](#) shows a typical configuration. As the output is a rectified sine wave, a boost-type power-factor circuit must follow the application.

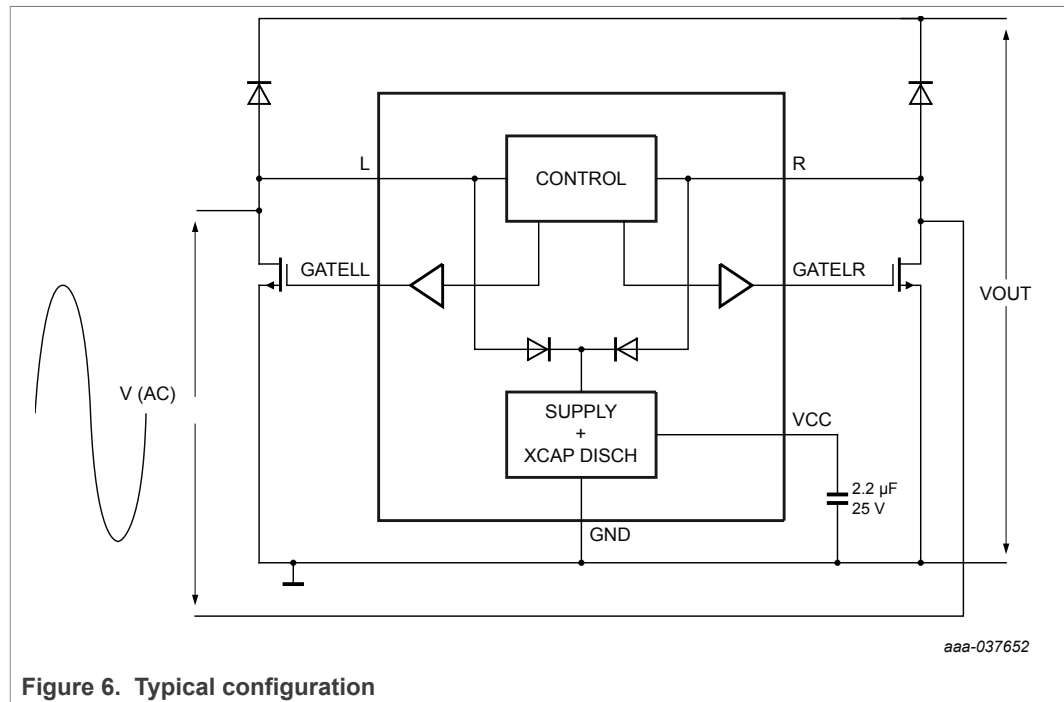

Figure 6. Typical configuration

The control circuit of the TEA2206T senses the polarity of the mains voltage between pins L and R. Depending on the polarity, either GATELL or GATELR is switched on. The comparator in the control circuit, which compares the L and R voltages, has thresholds of 250 mV and -250 mV depending on the slope polarity. If the difference voltage between L and R is less than 250 mV both GATELL and GATELR are low.

The gate drivers are high-current rail-to-rail MOS output drivers. An on-chip supply circuit which draws current from either L or R generates the gate driver voltage. After a zero-crossing of the mains voltage, the supply capacitor C_{VCC} is charged to the regulation level V_{reg} . Then the discharge state is entered. The resulting power dissipation from the mains voltage is about 1 mW excluding gate charge losses of the external power MOSFETs. These gate charge losses typically add 1 mW of dissipation.

At start-up, the supply capacitor is first charged to the V_{start} voltage and enters the start-up state. After a next zero-crossing of the mains voltage, the supply capacitor is charged to V_{reg} in the charging state. When the voltage at the supply capacitor exceeds V_{dis} , the gate driver outputs are enabled. When all drivers are active, the MOSFETs take over the role of the diodes which, compared to a passive diode rectifier bridge, results in lower power loss.

When the mains voltage is disconnected, the internal bias current in the discharge state discharges the supply capacitor. When the voltage at pin VCC drops to below V_{dis} , the X-capacitor discharge state is entered, which draws 2 mA of current from pin L or pin R to discharge the X-capacitor. The waiting time t_d until X-capacitor discharge starts is:

$$t_d = C_{VCC} * (V_{reg} - V_{dis}) / 20 \mu A = 0.2E6 * C_{VCC} \tag{1}$$

Using a typical value of 2.2 μ F for C_{VCC} yields about 0.45 s. While the L or R pin discharges the X-capacitor, the mains can be reconnected. In that case, the charge mode is entered again. [Figure 7](#) describes the start-up, the normal operation, and the power-off of the TEA2206T.

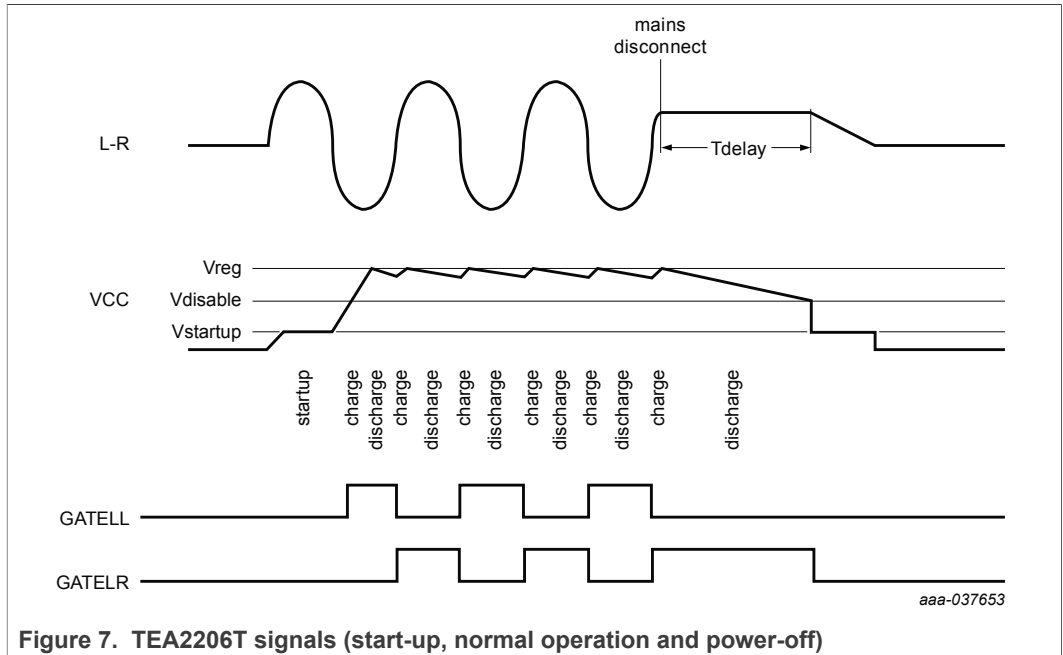

Figure 7. TEA2206T signals (start-up, normal operation and power-off)

6 Performance

6.1 Test facilities

- Oscilloscope: AgilentTechnologies DSOX3034T
- AC power source: Chroma 61504
- Electronic load: Chroma 63600-2
- Digital power meter: WT210
- Power board:
 - TEA2016DB1519

6.2 Test setup

To measure the system performance the TEA2206DB1583 is mounted on the TEA2016DB1519. The diode bridge rectifier, BD101, is removed from the TEA2016DB1519 and replaced by the TEA2206DB1583. [Figure 8](#) shows details of the test setup.

TEA2206DB1583 active bridge rectifier controller demo board

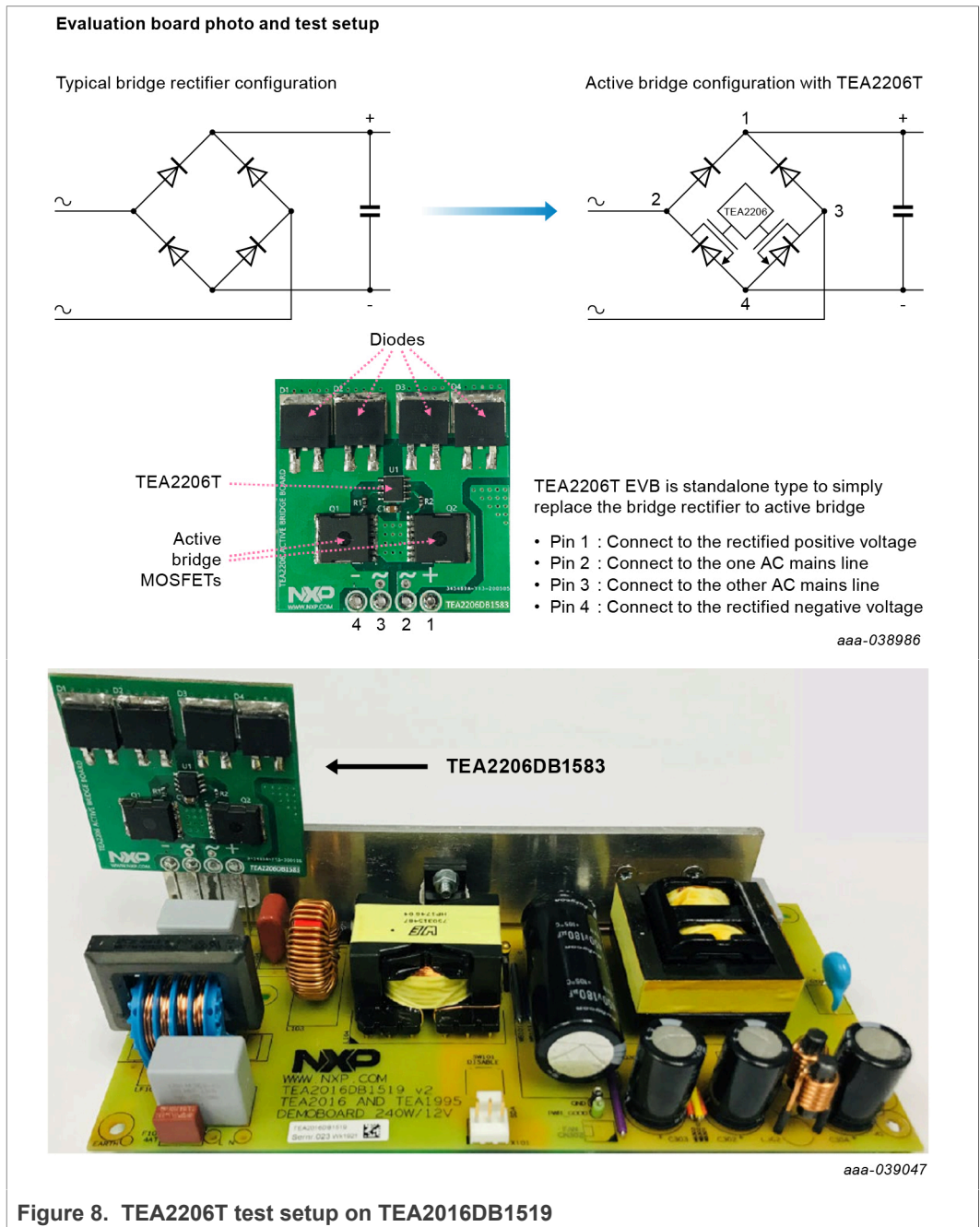
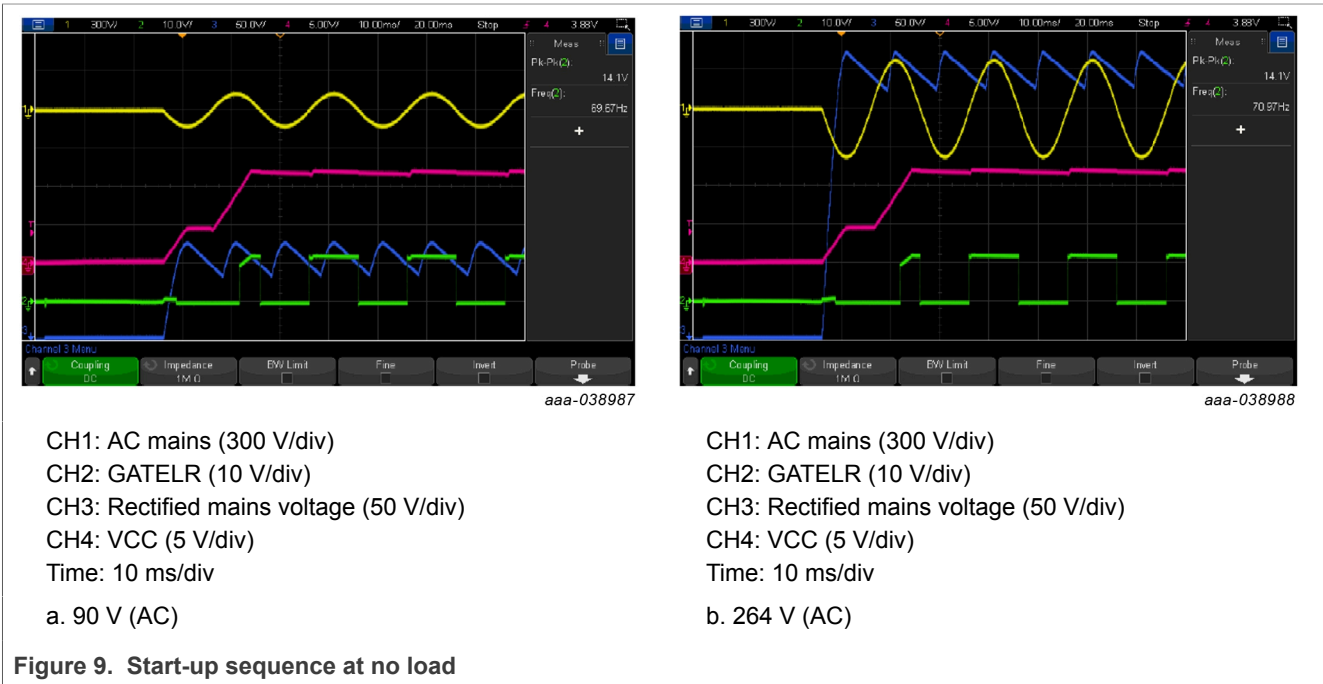

Figure 8. TEA2206T test setup on TEA2016DB1519

When the MOSFET pin open test for active bridge is required, add a diode in parallel to each active bridge MOSFET.

6.3 Start-up sequence

After AC mains voltage is applied, the body diodes of the MOSFET rectifiers are connected until the TEA2206T is enabled. The internal self-bias circuit from L and R, supplies the VCC. To complete the start-up sequence, it typically takes 1.5 mains cycles. [Figure 10](#) shows the start-up waveform at a 240 W load condition. Its initial period waveform is the same as a no-load waveform because the PFC boost converter does not start switching yet. When the TEA2206T is enabled, the 240 W load starts to be loaded and the rectified mains voltage shows higher ripple than the initial period.



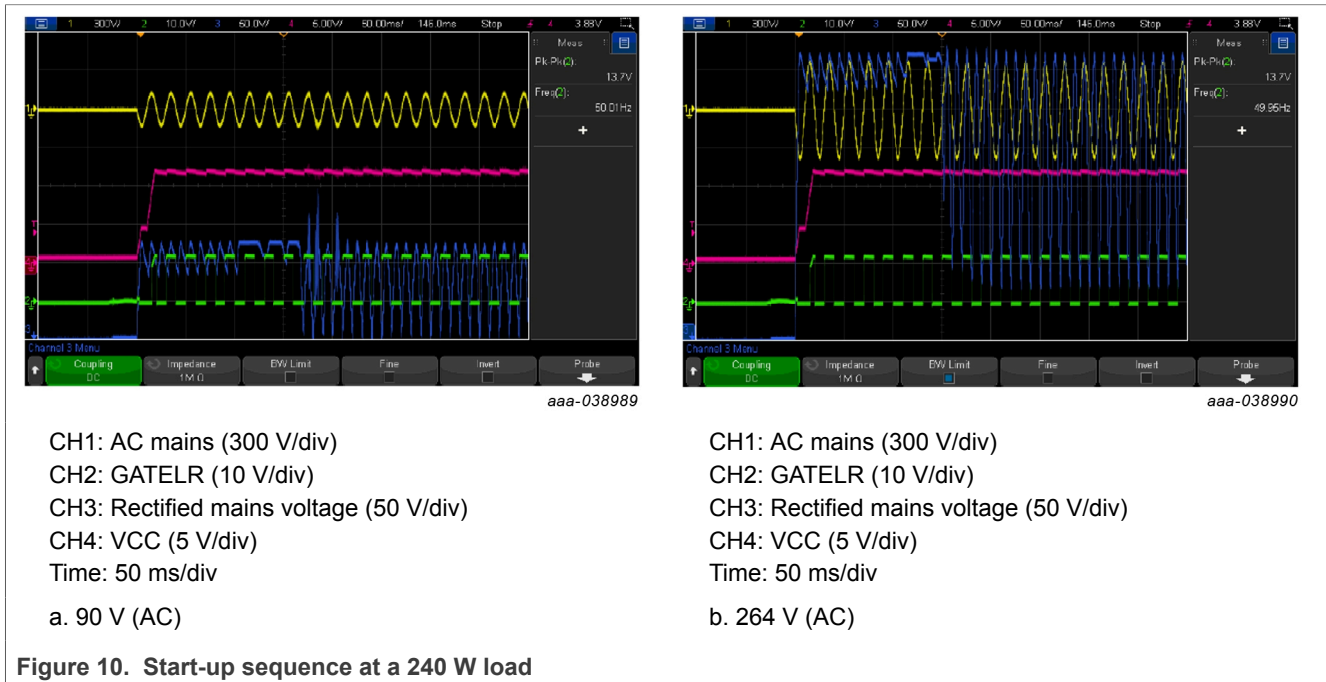

6.4 Normal operation

When the voltage between L and R is higher than 250 mV, the GATELR is enabled.
 When the voltage between L and R is lower than -250 mV, the GATELL is enabled.
 According to the +250 mV and -250 mV detection thresholds, dead time occurs between the gates.

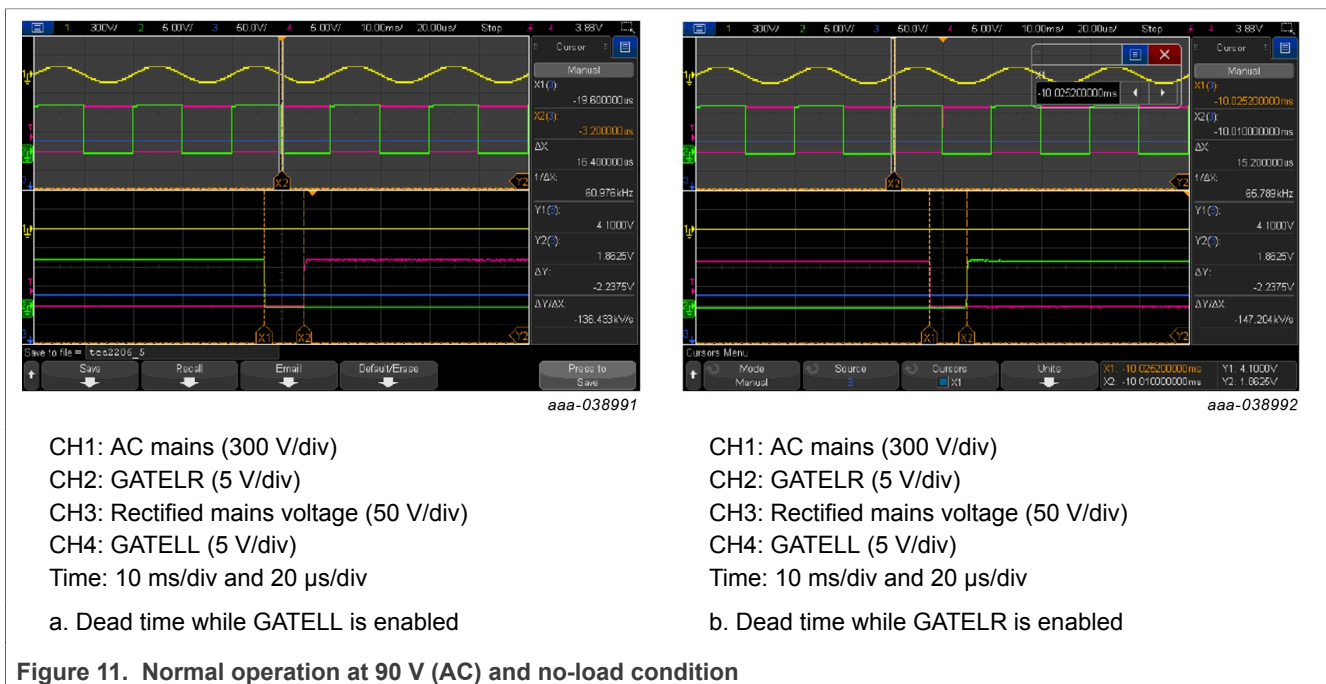

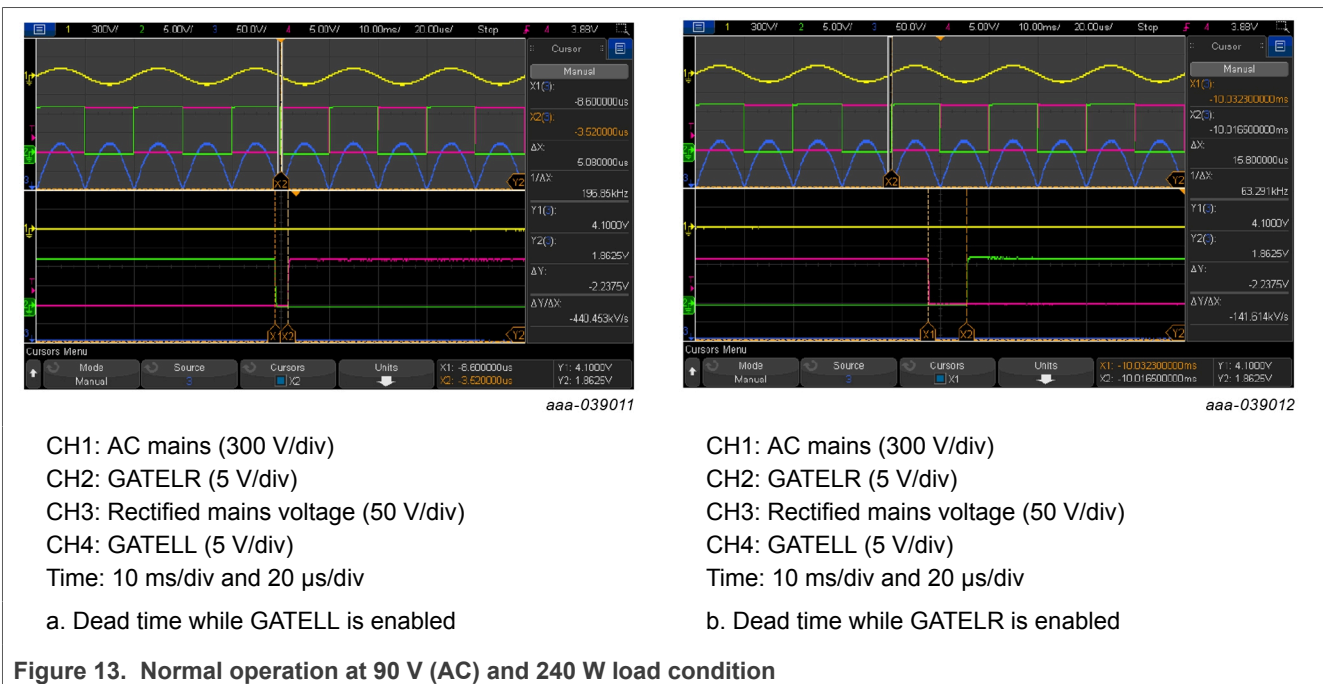
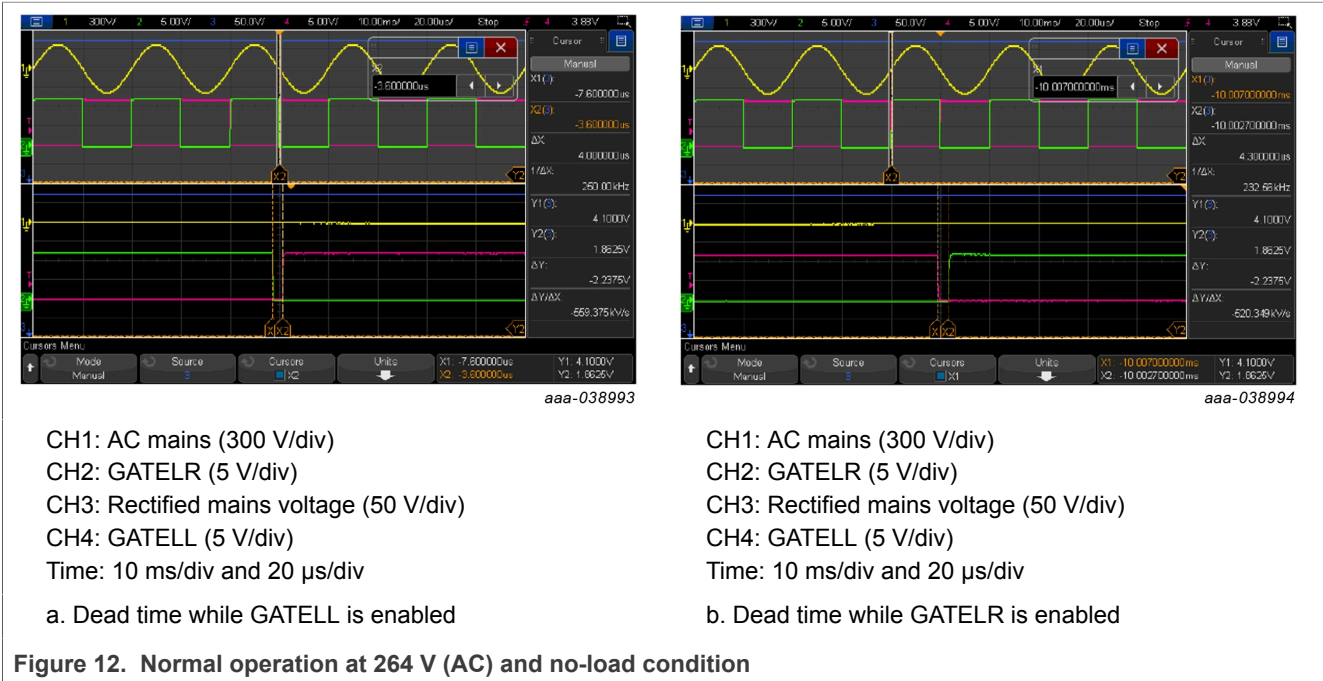

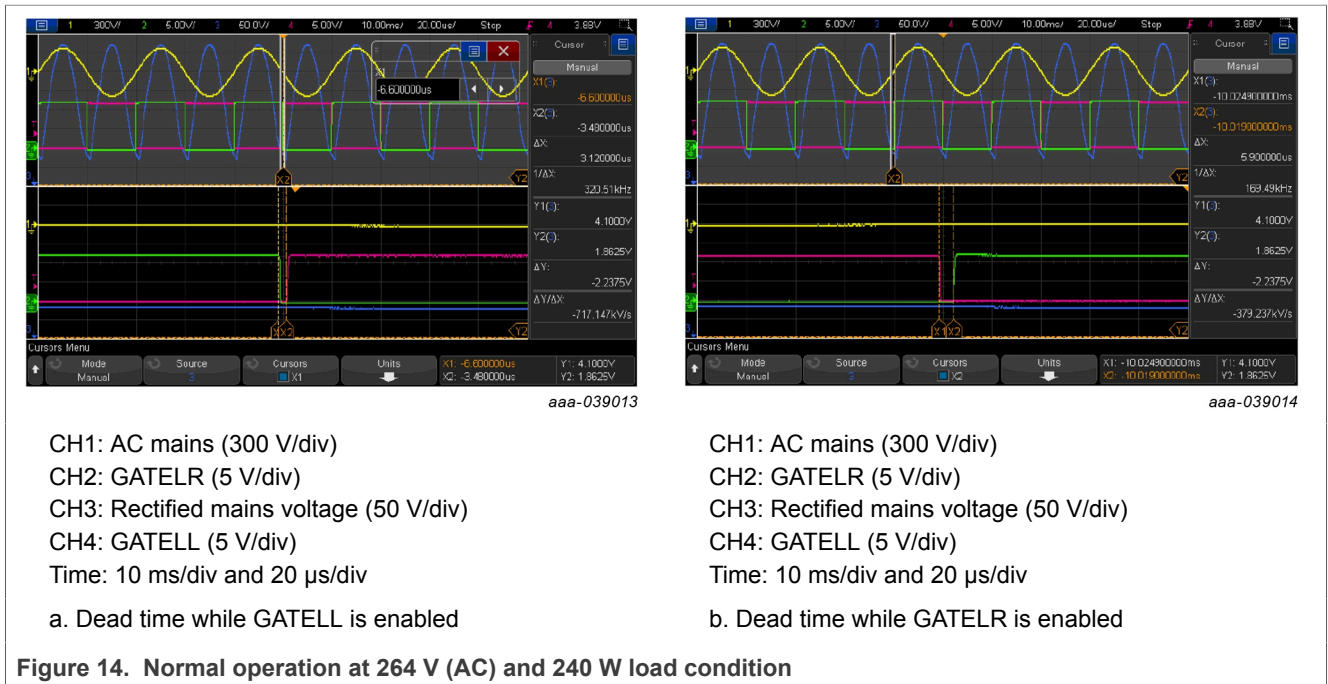

6.5 Output dynamic load condition operation

Output dynamic load is applied between a 240 W load condition and no-load condition. The dynamic load period is 14 ms. Regardless of the output load condition, the gates operate well in alignment with mains polarity without shoot-through.

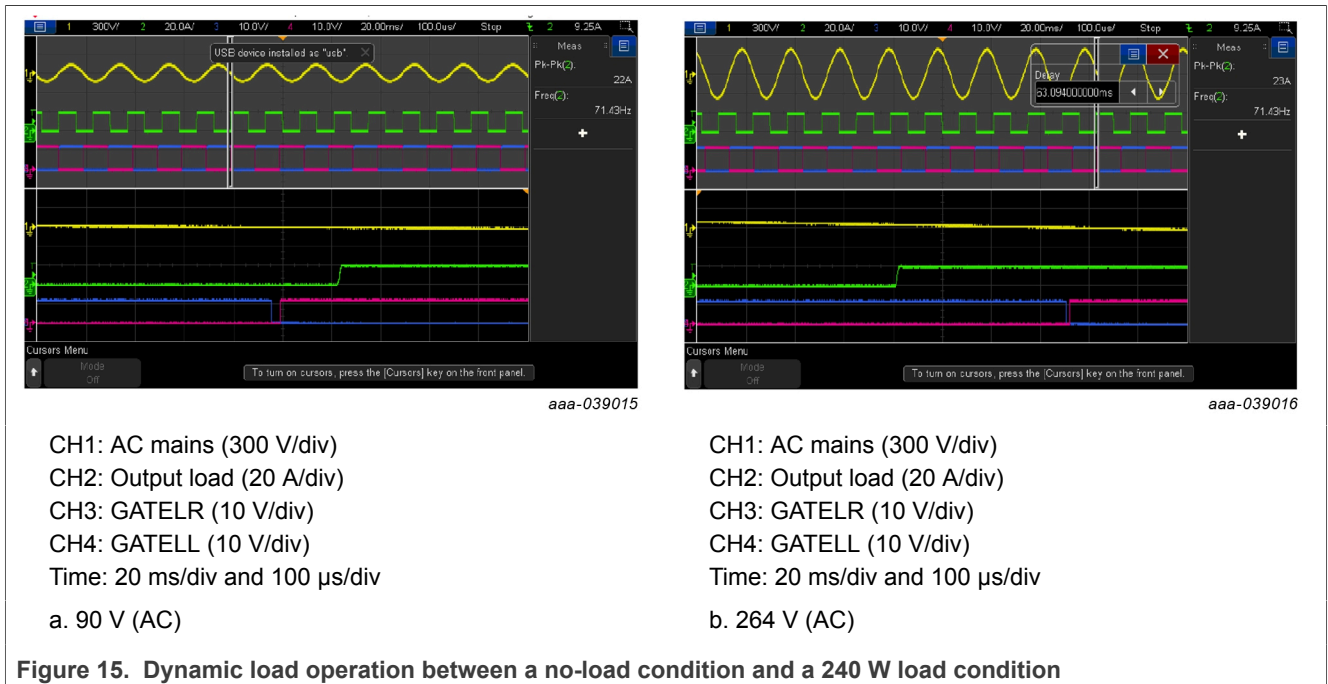

6.6 Efficiency test result and R_{DSon} selection

The efficiency test result includes power losses of bridge rectifiers and other power stages, such as PFC and LLC. However, throughout the active bridge incorporated in the TEA2206T an efficiency improvement compared a diode bridge can be seen. Depending on the different R_{DSon} values of the active bridge MOSFET, the efficiency improvement varies.

Figure 16 shows the comparison between different MOSFET R_{DSon} values and the number of diodes in parallel at 115 V (AC). To see the improvement achieved with the active bridge with a MOSFET at its worst condition, the efficiency is calculated at a junction temperature of 125 °C. The efficiency improvement can reduce the temperature on the bridge rectifier. It helps to increase power density.

Table 1. Efficiency comparison on TEA2016DB1519 at 115 V (AC) and a 240 W load

	TEA2206DB1583 (%)	Diode bridge (%)
Efficiency	90.17	89.39

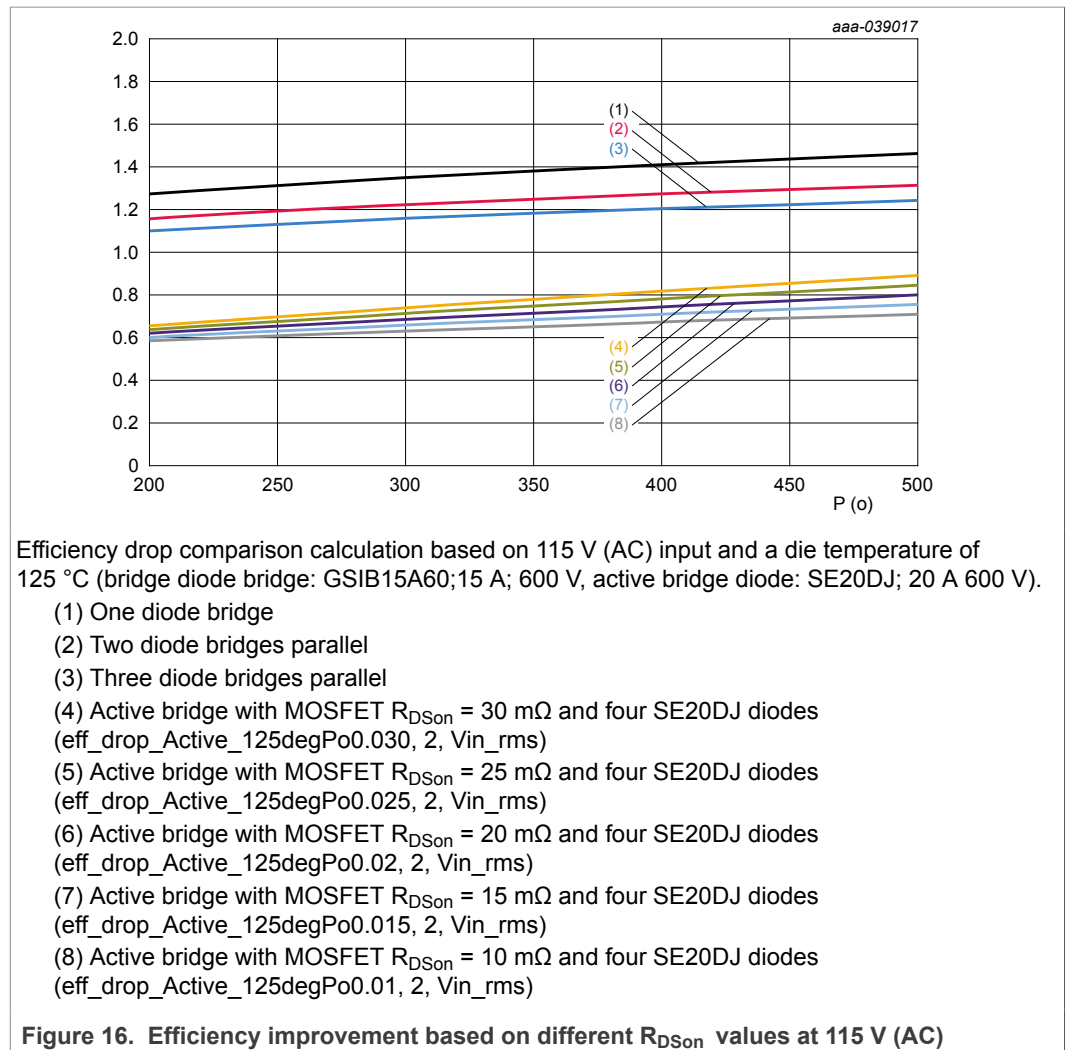

Example:

When an R_{DSon} of 0.015Ω is used on a MOSFET for a 500 W design, the efficiency improvement that can be achieved, when compared to a single diode for a diode bridge, is 0.708 %.

6.7 Standby power consumption test result

Standby power consumption with TEA2206DB1583 is almost same as diode bridge. The power consumption of the TEA2206T and the active bridge MOSFET gate driving loss are only about 2 mW.

Table 2. Standby power consumption measurement result at a 230 V (AC) and a no-load condition

	TEA2206DB1583 standalone board (mW)	Total power loss of the TEA2016DB1519 and the TEA2206DB1583 (mW)
Standby power consumption	1.9	58.3

6.8 AC power-off sequence and X-capacitor discharge test

If the X-capacitor discharge function is activated, the discharge current flows from L or R to ground via the internal path of the IC. After the AC mains is disconnected, the VCC capacitor is discharged. While VCC is discharged to V_{dis} , the X-capacitor discharge current is not enabled. This delay time (t_d) can be adjusted with different VCC capacitors. After VCC is decreased to V_{dis} , the X-capacitor discharge current is enabled. It takes 120 ms to discharge the 940 nF X-capacitor. While the X-capacitor is discharged, the capacitor on the rectified mains voltage is not discharged because the discharge path is from L or R to ground.

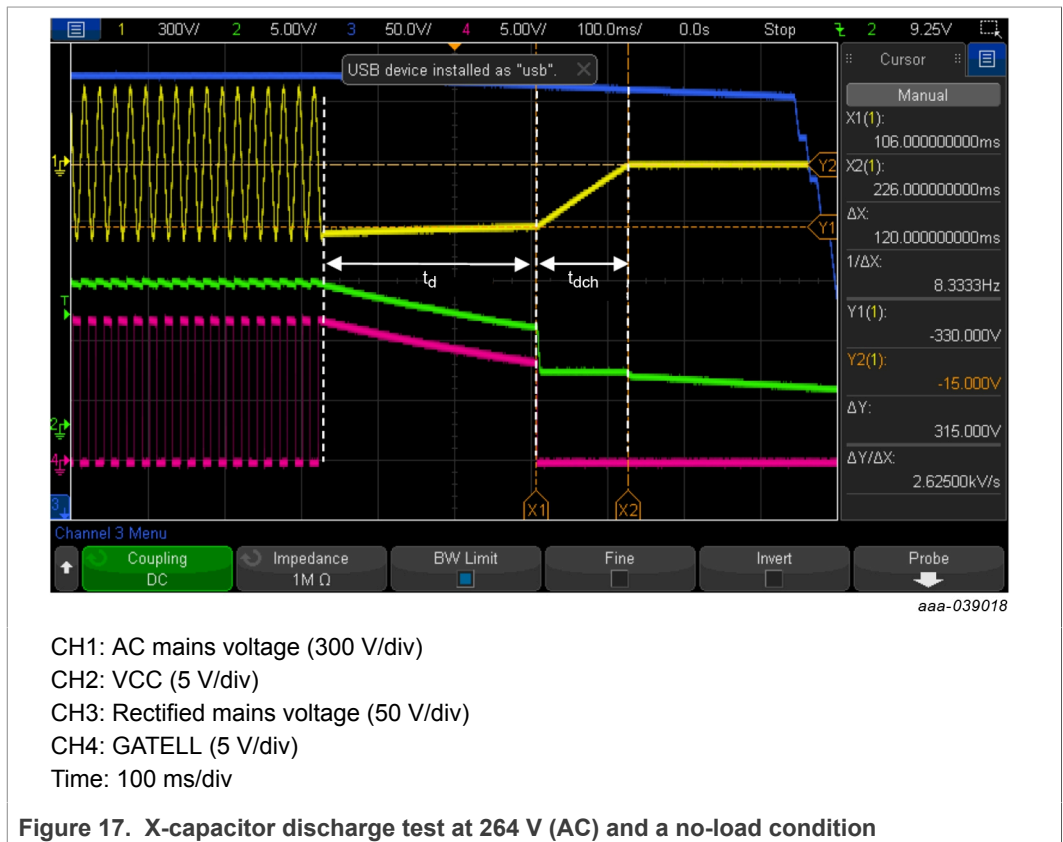

6.9 AC mains transition test

When AC mains voltage is changed from high mains to low mains, or vice versa, no shoot-through occurs. The active bridge operates normally.

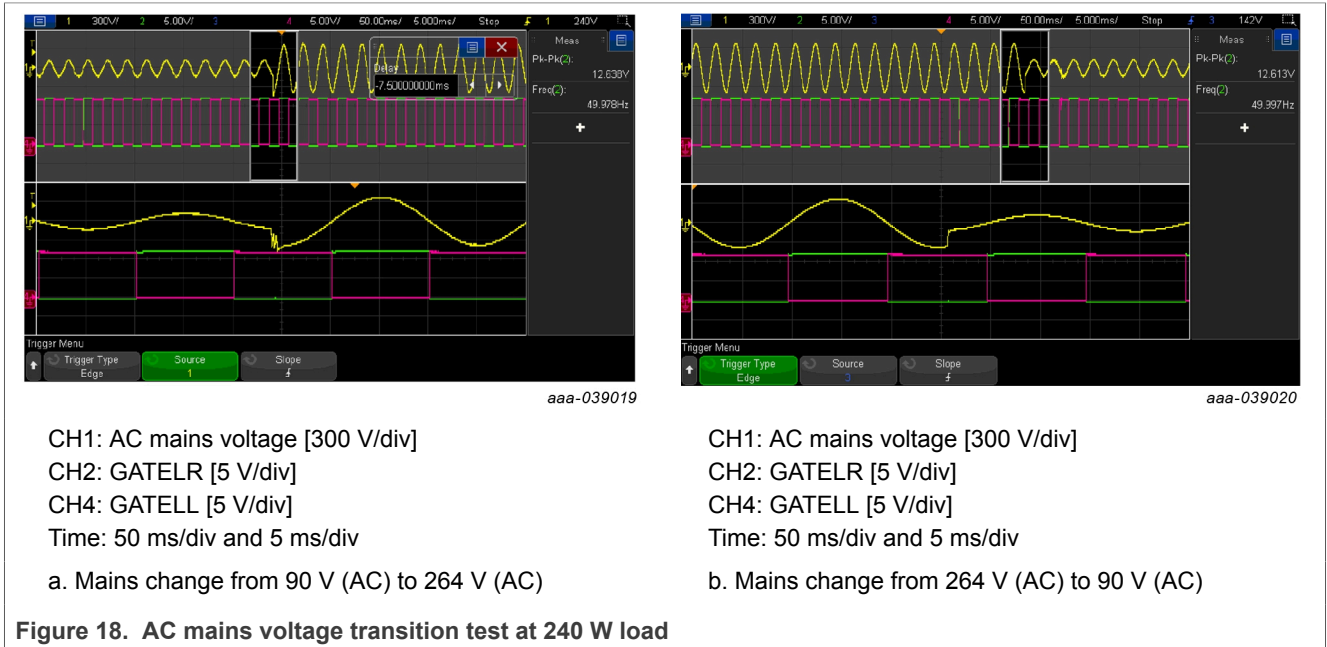

6.10 Surge test result

To test the system surge, the TEA2206DB1583 is mounted on the TEA2016DB1519. In addition, one MOV, 14D511, is added between two AC mains lines. Figure 19 shows the MOV position. Surge test can pass up to 5 kV without damage, which is same test result as with the diode bridge. Additionally, to increase power capability, R107 and R108 on the TEA2016DB1519 are changed to a metal alloy type. The R106 power rating is also increased.

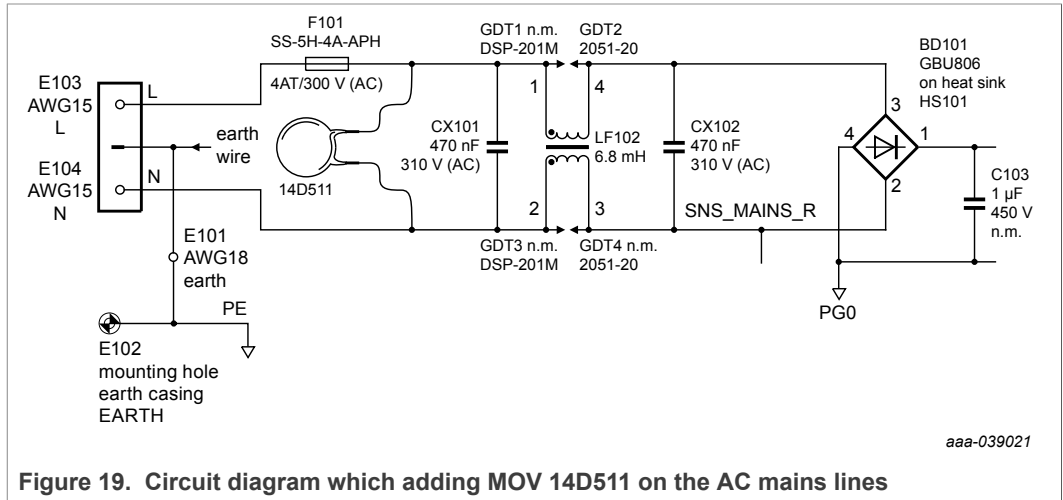
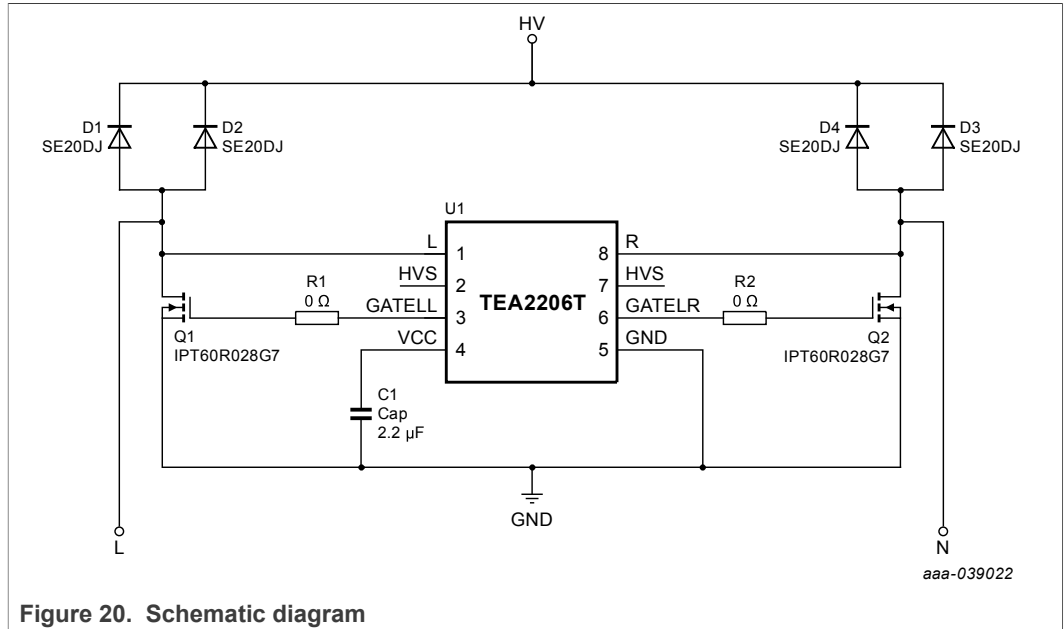

Figure 19. Circuit diagram which adding MOV 14D511 on the AC mains lines

Table 3. Surge test result, EN61000-4-5

Surge voltage (V)	Surge degree	Test result
1000	0 deg, 90 deg, 180 deg, 270 deg	pass without damage
2000	0 deg, 90 deg, 180 deg, 270 deg	pass without damage
3000	0 deg, 90 deg, 180 deg, 270 deg	pass without damage
4000	0 deg, 90 deg, 180 deg, 270 deg	pass without damage
5000	0 deg, 90 deg, 180 deg, 270 deg	pass without damage

7 Schematic



8 Bill of materials (BOM)

Table 4. Bill of materials (BOM)

Part reference	Values and description	Part number	Manufacturer
C1	capacitor; 2.2 μF; 10 %; 25 V; X7R; 0805	-	-
Q1; Q2	MOSFET-N; 600 V; 75 A	IPT60R028G7	Infineon
D1; D2; D3; D4	diode; 600 V; 20 A	SE20DJ	Vishay
R1; R2	resistor; jumper; 0 Ω; 100 mW; 0603	-	-
U1	active bridge rectifier controller	TEA2206T	NXP Semiconductors

9 Layout

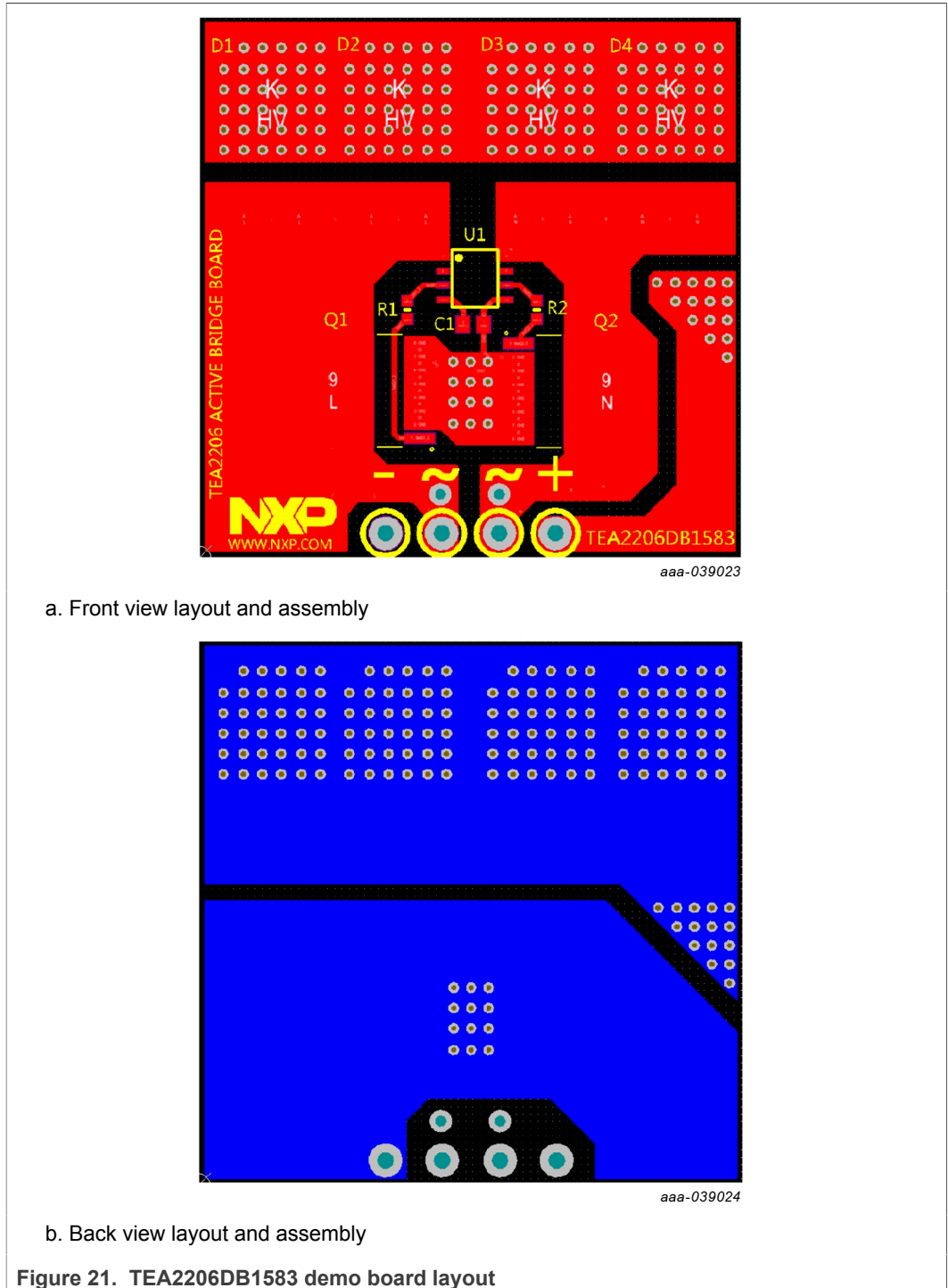

10 Abbreviations

Table 5. Abbreviations

Acronym	Description
MOSFET	metal-oxide semiconductor field-effect transistor
UVLO	undervoltage lockout
THD	total harmonic distortion
PCB	printed-circuit board

11 References

- [1] **TEA2206T data sheet** — Active bridge rectifier controller; 2020, NXP Semiconductors

12 Legal information

12.1 Definitions

Draft — A draft status on a document indicates that the content is still under internal review and subject to formal approval, which may result in modifications or additions. NXP Semiconductors does not give any representations or warranties as to the accuracy or completeness of information included in a draft version of a document and shall have no liability for the consequences of use of such information.

12.2 Disclaimers

Limited warranty and liability — Information in this document is believed to be accurate and reliable. However, NXP Semiconductors does not give any representations or warranties, expressed or implied, as to the accuracy or completeness of such information and shall have no liability for the consequences of use of such information. NXP Semiconductors takes no responsibility for the content in this document if provided by an information source outside of NXP Semiconductors. In no event shall NXP Semiconductors be liable for any indirect, incidental, punitive, special or consequential damages (including - without limitation - lost profits, lost savings, business interruption, costs related to the removal or replacement of any products or rework charges) whether or not such damages are based on tort (including negligence), warranty, breach of contract or any other legal theory. Notwithstanding any damages that customer might incur for any reason whatsoever, NXP Semiconductors' aggregate and cumulative liability towards customer for the products described herein shall be limited in accordance with the Terms and conditions of commercial sale of NXP Semiconductors.

Right to make changes — NXP Semiconductors reserves the right to make changes to information published in this document, including without limitation specifications and product descriptions, at any time and without notice. This document supersedes and replaces all information supplied prior to the publication hereof.

Suitability for use — NXP Semiconductors products are not designed, authorized or warranted to be suitable for use in life support, life-critical or safety-critical systems or equipment, nor in applications where failure or malfunction of an NXP Semiconductors product can reasonably be expected to result in personal injury, death or severe property or environmental damage. NXP Semiconductors and its suppliers accept no liability for inclusion and/or use of NXP Semiconductors products in such equipment or applications and therefore such inclusion and/or use is at the customer's own risk.

Applications — Applications that are described herein for any of these products are for illustrative purposes only. NXP Semiconductors makes no representation or warranty that such applications will be suitable for the specified use without further testing or modification. Customers are responsible for the design and operation of their applications and products using NXP Semiconductors products, and NXP Semiconductors accepts no liability for any assistance with applications or customer product design. It is customer's sole responsibility to determine whether the NXP Semiconductors product is suitable and fit for the customer's applications and products planned, as well as for the planned application and use of customer's third party customer(s). Customers should provide appropriate design and operating safeguards to minimize the risks associated with their applications and products. NXP Semiconductors does not accept any liability related to any default, damage, costs or problem which is based on any weakness or default in the customer's applications or products, or the application or use by customer's third party customer(s). Customer is

responsible for doing all necessary testing for the customer's applications and products using NXP Semiconductors products in order to avoid a default of the applications and the products or of the application or use by customer's third party customer(s). NXP does not accept any liability in this respect.

Export control — This document as well as the item(s) described herein may be subject to export control regulations. Export might require a prior authorization from competent authorities.

Evaluation products — This product is provided on an "as is" and "with all faults" basis for evaluation purposes only. NXP Semiconductors, its affiliates and their suppliers expressly disclaim all warranties, whether express, implied or statutory, including but not limited to the implied warranties of non-infringement, merchantability and fitness for a particular purpose. The entire risk as to the quality, or arising out of the use or performance, of this product remains with customer. In no event shall NXP Semiconductors, its affiliates or their suppliers be liable to customer for any special, indirect, consequential, punitive or incidental damages (including without limitation damages for loss of business, business interruption, loss of use, loss of data or information, and the like) arising out of the use of or inability to use the product, whether or not based on tort (including negligence), strict liability, breach of contract, breach of warranty or any other theory, even if advised of the possibility of such damages. Notwithstanding any damages that customer might incur for any reason whatsoever (including without limitation, all damages referenced above and all direct or general damages), the entire liability of NXP Semiconductors, its affiliates and their suppliers and customer's exclusive remedy for all of the foregoing shall be limited to actual damages incurred by customer based on reasonable reliance up to the greater of the amount actually paid by customer for the product or five dollars (US\$5.00). The foregoing limitations, exclusions and disclaimers shall apply to the maximum extent permitted by applicable law, even if any remedy fails of its essential purpose.

Translations — A non-English (translated) version of a document is for reference only. The English version shall prevail in case of any discrepancy between the translated and English versions.

Security — Customer understands that all NXP products may be subject to unidentified or documented vulnerabilities. Customer is responsible for the design and operation of its applications and products throughout their lifecycles to reduce the effect of these vulnerabilities on customer's applications and products. Customer's responsibility also extends to other open and/or proprietary technologies supported by NXP products for use in customer's applications. NXP accepts no liability for any vulnerability. Customer should regularly check security updates from NXP and follow up appropriately. Customer shall select products with security features that best meet rules, regulations, and standards of the intended application and make the ultimate design decisions regarding its products and is solely responsible for compliance with all legal, regulatory, and security related requirements concerning its products, regardless of any information or support that may be provided by NXP. NXP has a Product Security Incident Response Team (PSIRT) (reachable at PSIRT@nxp.com) that manages the investigation, reporting, and solution release to security vulnerabilities of NXP products.

12.3 Trademarks

Notice: All referenced brands, product names, service names and trademarks are the property of their respective owners.

GreenChip — is a trademark of NXP B.V.

NXP — wordmark and logo are trademarks of NXP B.V.