



TAOGLAS®



Datasheet

L1/L5 Surface Mount GNSS Front-End Module

Part No:
TFM.100B

Description

Surface mount GNSS front-end module covering L1/L5

Features:

Two-stage LNA providing >25 dB Gain across all bands

Low Noise Figure: <3.0 dB in all bands

Vin = +1.8 to +5.5 VDC

Easy to integrate surface-mount module

Dimensions: 20 mm x 18 mm

RoHS & Reach Compliant

1.	Introduction	2
2.	Specification	3
3.	FEM Low Band Characteristics	4
4.	FEM High Band Characteristics	7
5.	Mechanical Drawing	10
6.	Eval Board Mechanical Drawing	11
7.	Module Integration	12
8.	Solder Reflow Recommendations	21
9.	Packaging	22
<hr/>		
	Changelog	23

Taoglas makes no warranties based on the accuracy or completeness of the contents of this document and reserves the right to make changes to specifications and product descriptions at any time without notice. Taoglas reserves all rights to this document and the information contained herein. Reproduction, use or disclosure to third parties without express permission is strictly prohibited.



1. Introduction



The Taoglas TFM.100B is a surface-mount GNSS front-end module which covers L1 /L5 for dual-band high-precision applications. The module features a SAW/LNA/SAW/LNA topology in both the low and high band signal paths to prevent unwanted out-of-band interference from overdriving the GNSS LNAs or receiver. The SAW filters have been carefully selected and placed to provide excellent out-of-band rejection while also maintaining low noise figure.

Many currently available dual-band GNSS receivers require additional RF circuits between the antenna and the receiver to properly set the overall system noise figure. This requires additional development time for an otherwise simple module integration. Many organizations don't have the RF expertise to effectively design such a solution. The TFM.100B captures the required additional RF circuits in modular form, allowing the designer to simply place the TFM.100B between their GNSS antenna and GNSS receiver.

The TFM.100B offers > 25 dB gain across all applicable bands while maintaining a high P1dB of -26 dBm or better. Noise Figure is < 3.0 dB in all applicable bands. A wide input voltage of +1.8 to +5.5 VDC allows for easy integration in most GNSS systems.

Taoglas also offers the TFM.100A for L1+B1+G1/L2 applications.

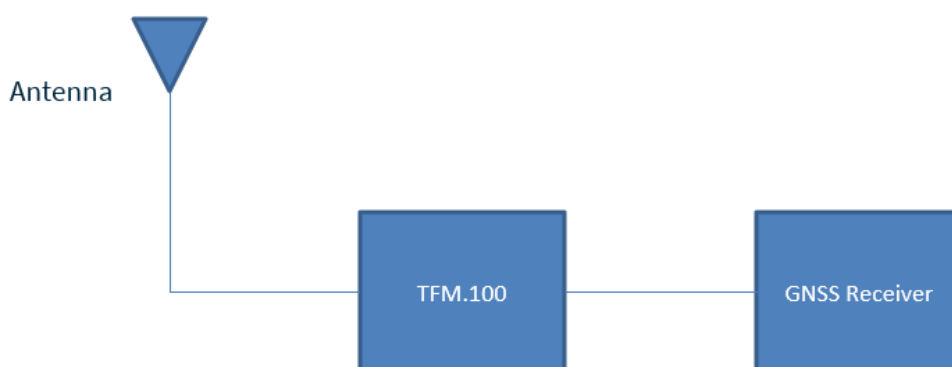

2. Specification

Electrical						
Frequency (MHz)	1166	1176	1186	1559	1575.42	1606
Noise Figure (dB)*	2.2	2.3	2.5	2.5	2.2	2.9
Gain (dB)	28	28	28	26	27	25
Group Delay (ns)	35	35	39	39	29	32
Input P1dB (dBm)	-25	-25	-24	-22	-22	-21
Input Return Loss (dB)	-12	-19	-18	-15	-15	-10
Output Return Loss	-6	-6	-6	-8	-8	-8
Noise Figure (dB)*	+1.8 to +5.5 VDC					

*Note: Tested on evaluation board. Board losses removed.

Mechanical	
Height	2.76 mm max.
Planar Dimension	20 mm x 18 mm
Weight	2g

Environmental	
Temperature Range	-40°C to 85°C
RoHS Compliant	Yes
REACH Compliant	Yes

3. FEM Low Band Characteristics

3.1 Low Band Input Return Loss

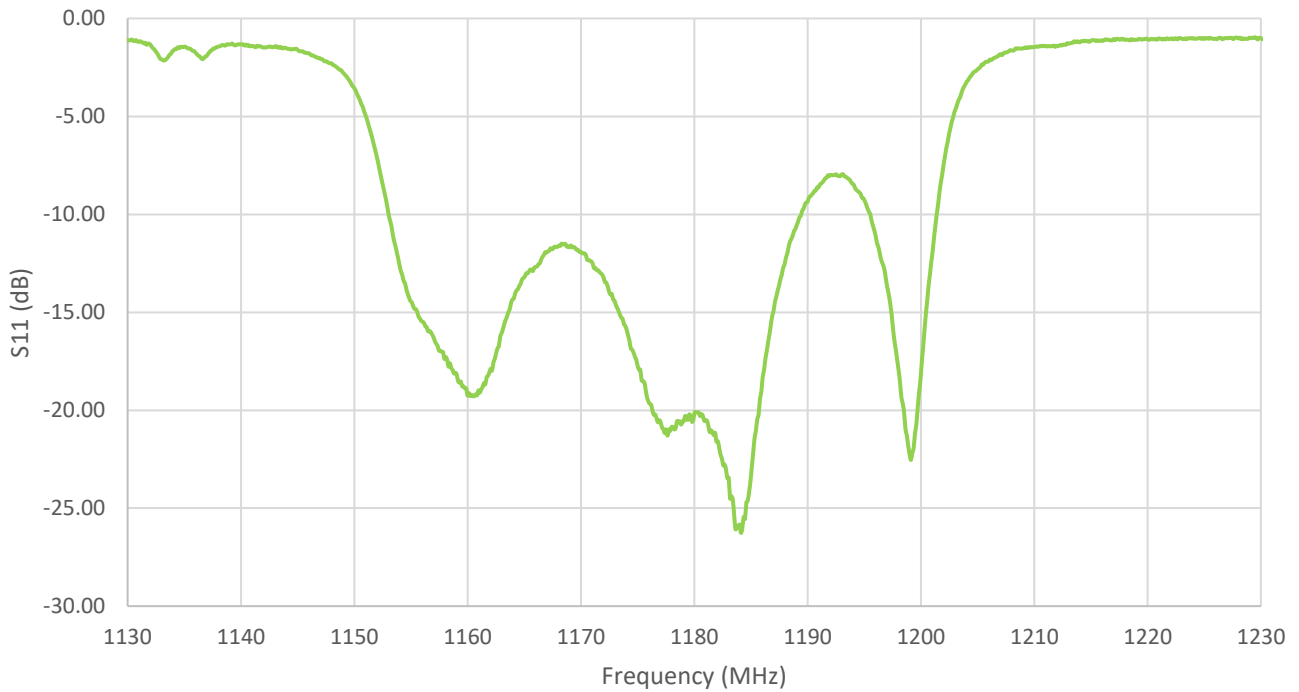

3.2 Low Band Output Return Loss

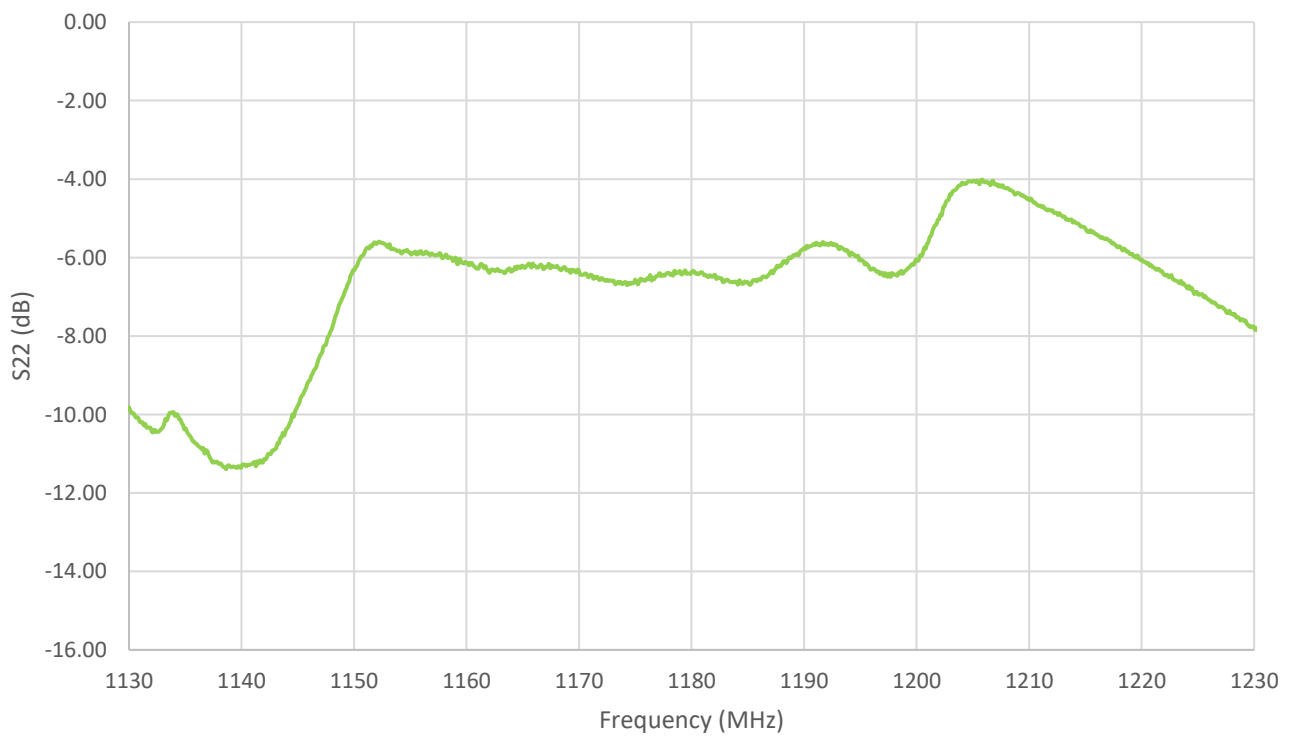

3.3 Low Band Noise Figure

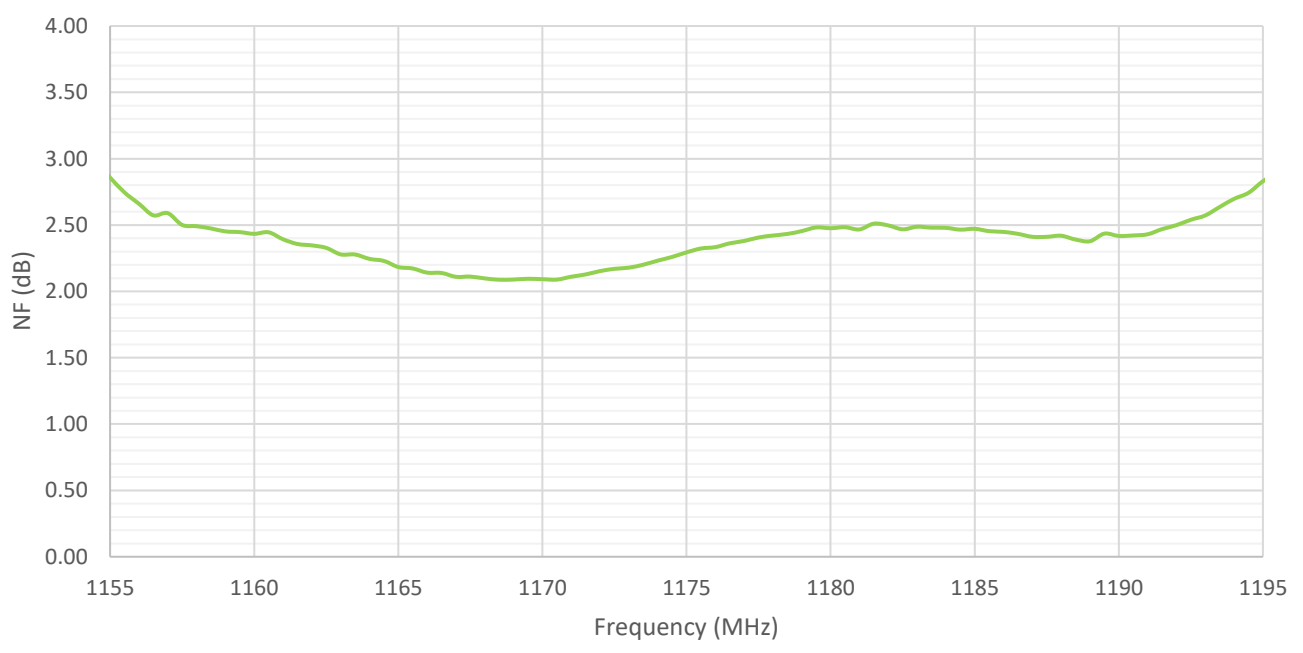

3.4 Low Band Gain



3.5 Low Band Gain and Attenuation

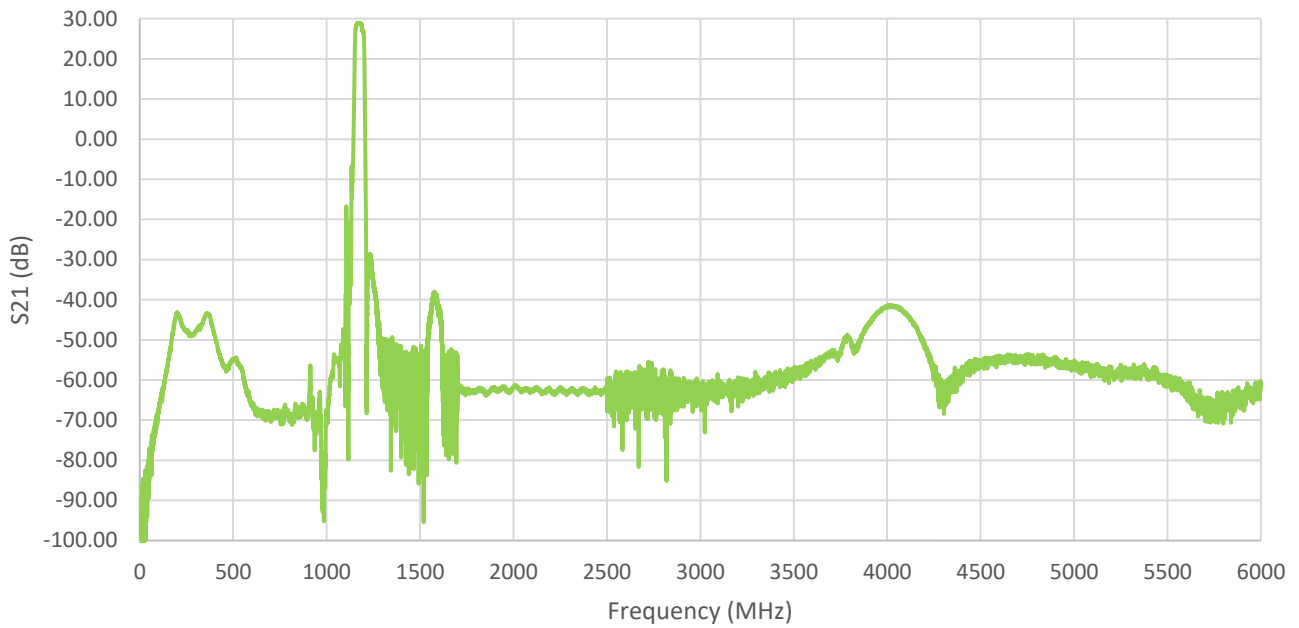

3.6 Low Band Group Delay

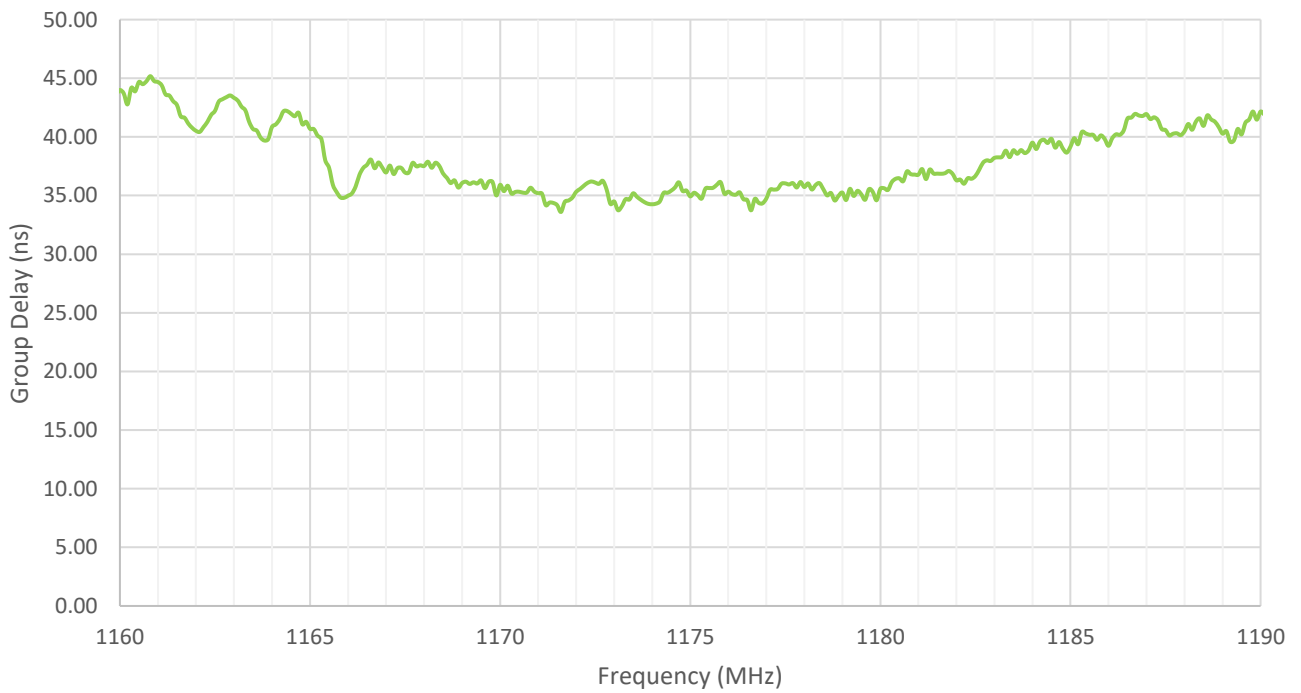

4. FEM High Band Characteristics

4.1 High Band Input Return Loss

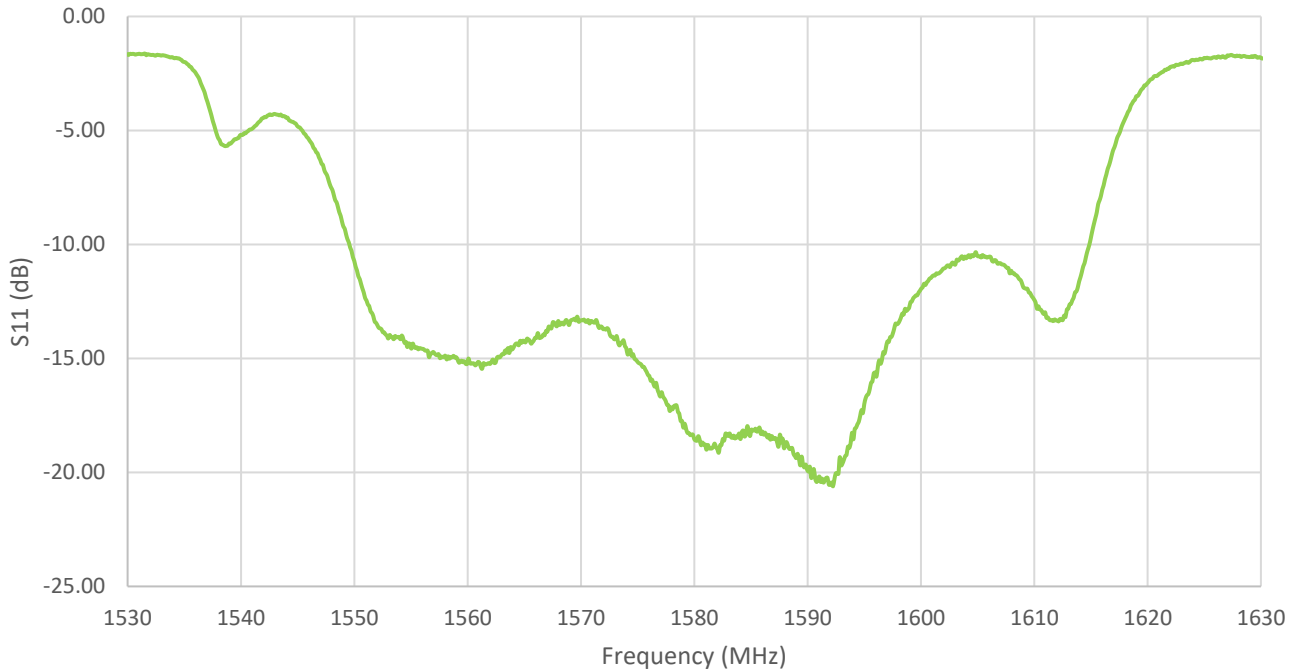

4.2 High Band Output Return Loss

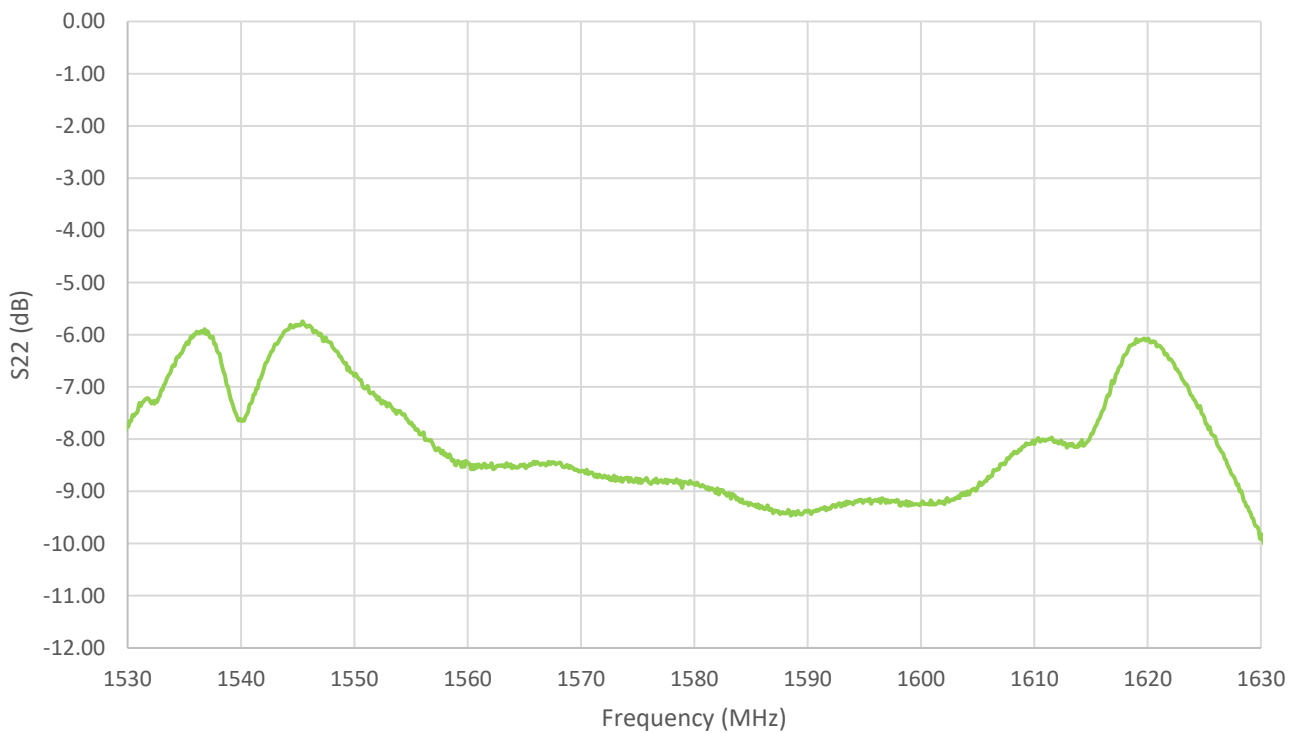

4.3 High Band Noise Figure

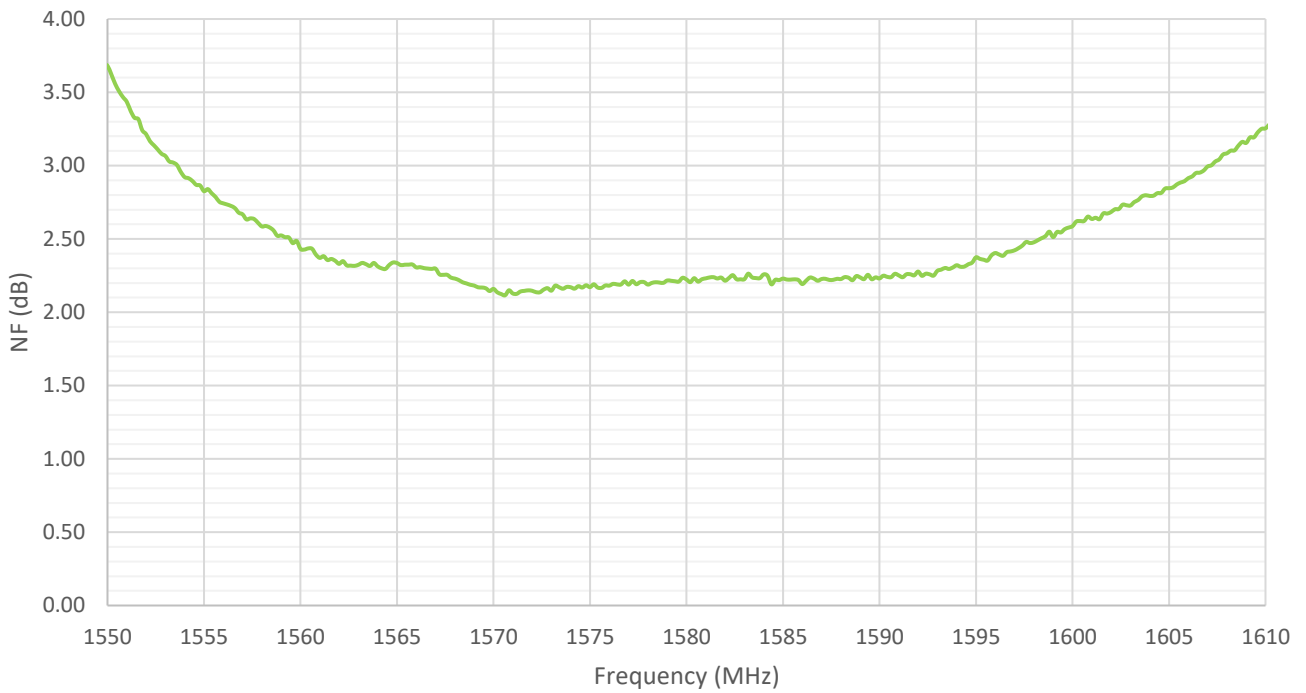

4.4 High Band Gain

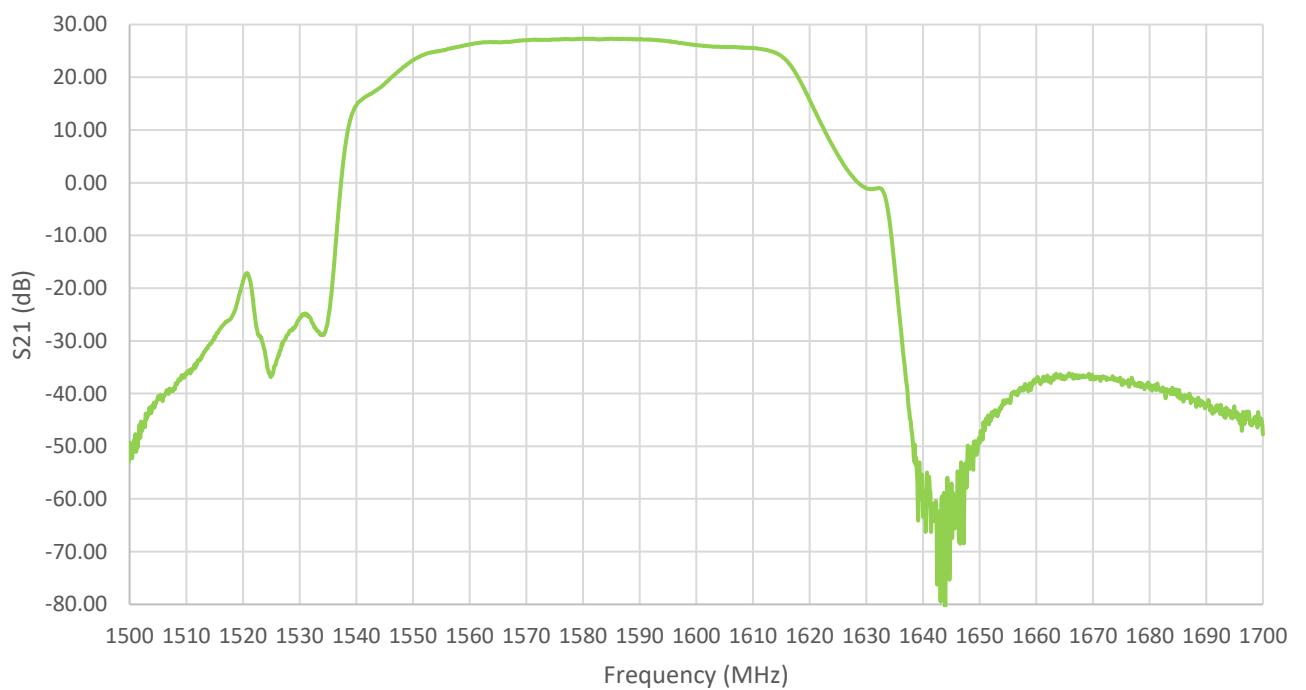

4.5 High Band Gain and Attenuation

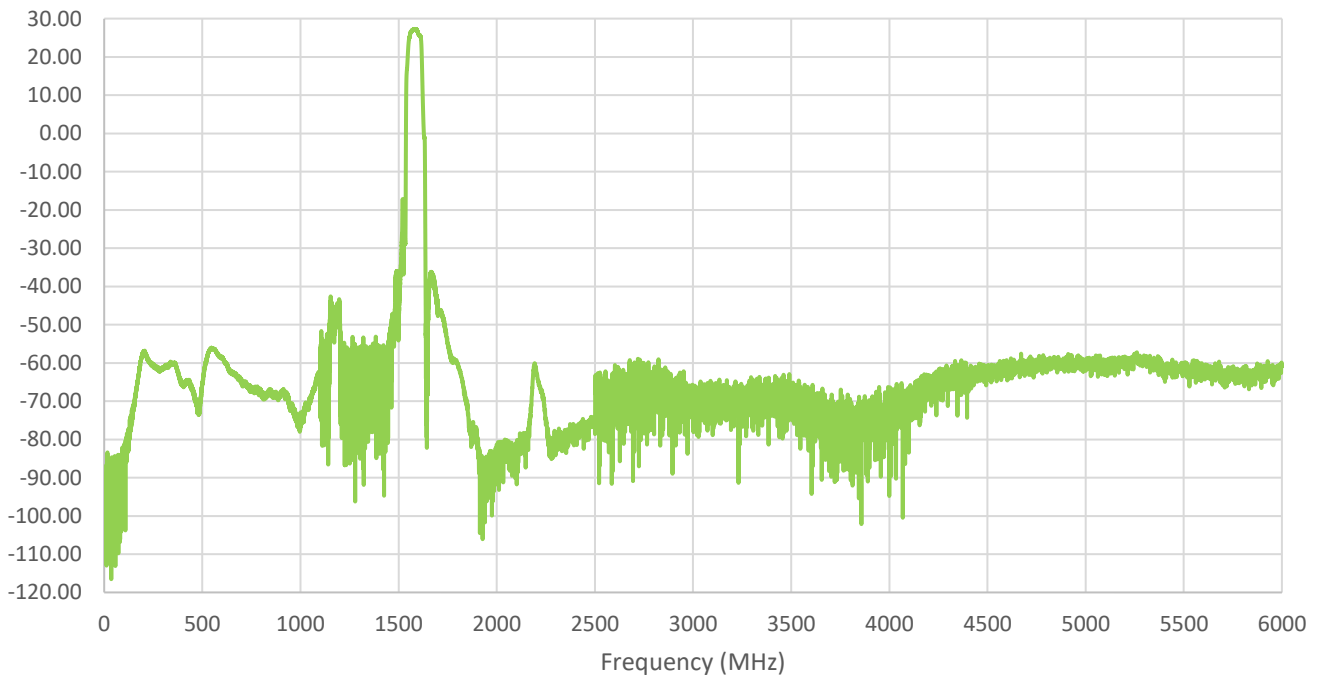

4.6 High Band Group Delay

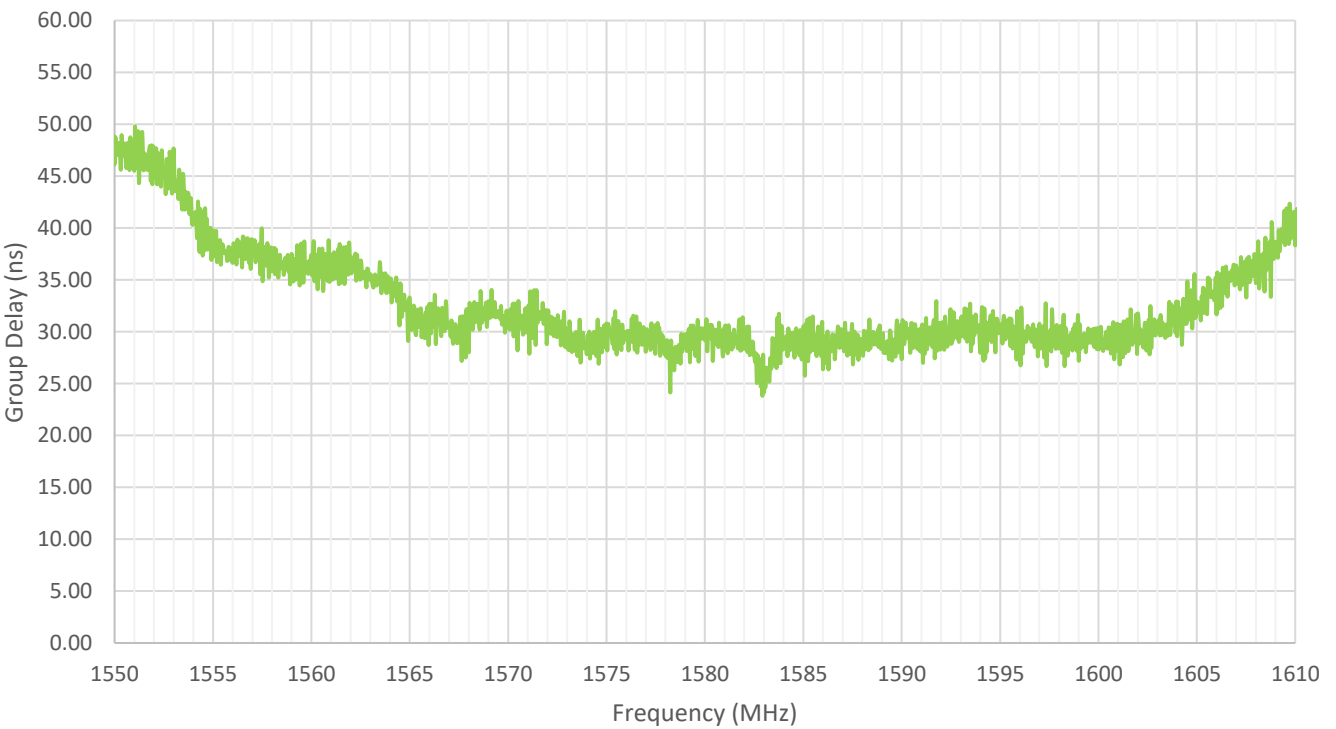

5. Mechanical Drawing

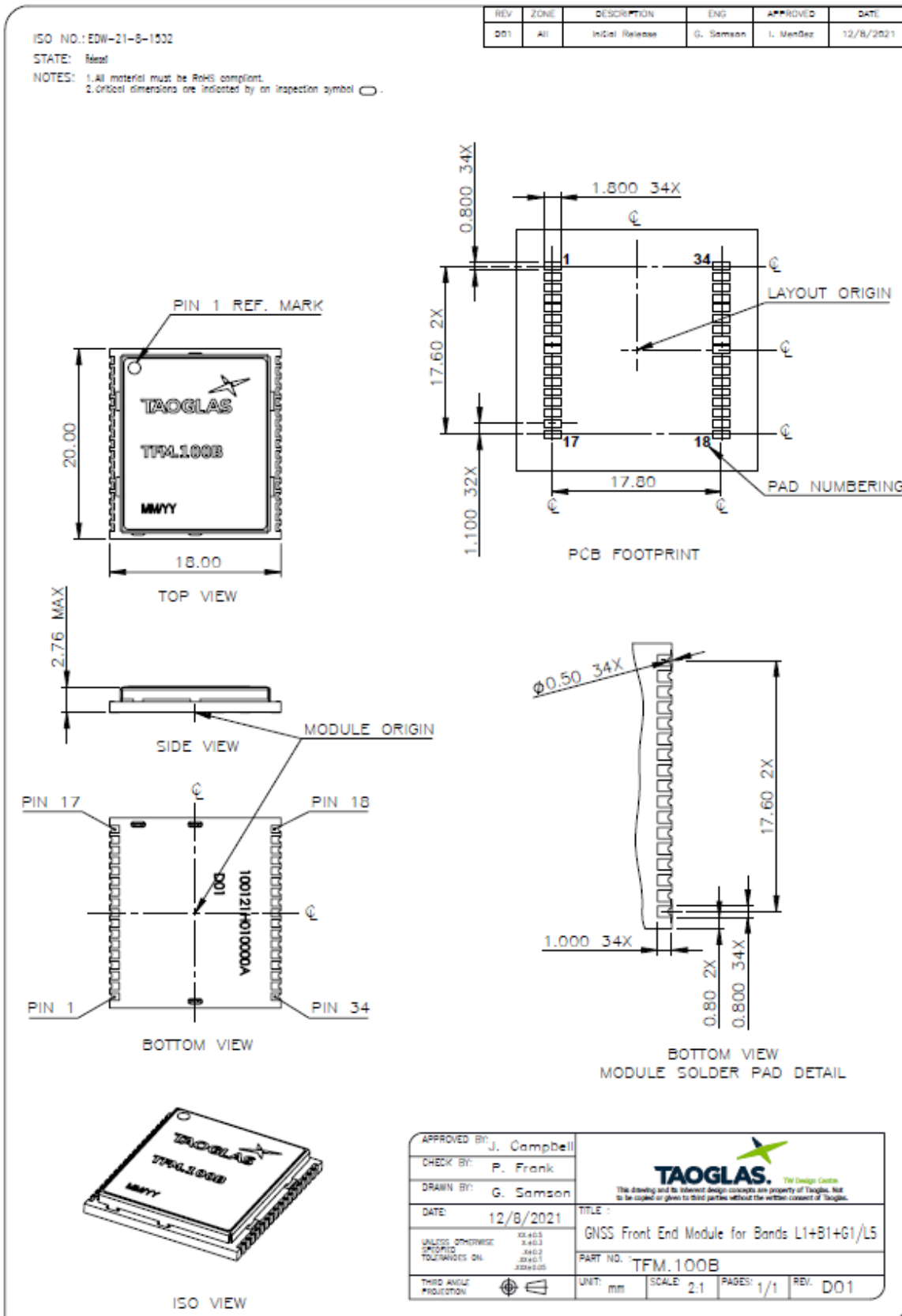

6. Eval Board Mechanical Drawing

ISO NO.: EDW-22-8-0104

STATE: Released

NOTES: 1. All material must be RoHS compliant.
2. Use this drawing together with the corresponding 3D CAD database file to fully describe the part.
3. Critical dimensions are indicated by an inspection symbol \square .

REV	ZONE	DESCRIPTION	ENG	APPROVED	DATE
001	All	In Col Release	G. Samson	I. Mendez	1/27/2022

Top view dimensions: 45 mm height, 50 mm width. Callouts 1-7 point to various components.

Side view dimensions: 2.54 mm (height of RF connector), 3.05 mm (height of board), 8.38 mm (total height).

	Name	Material	Designator	QTY
1	TFM-100B GNSS Front End Module	NA	U1	1
2	TFM100 GNSS Evaluation PCB	FR4	NA	1
3	Connector, Header, Vert. 2 Position, 2.54 mm	Brass/PhosCo	J3	1
4	SMA Jack, 50 Ohm, PCB Edge Mount	Brass	J1, J2, J4	3
5	Ceramic Capacitor, 1000pF, 0603	Ceramic	C1, C2, C7	3
6	TVS Diode, 5.5 VWM, 7.5VC WLL-3-3	NA	D1	1

APPROVED BY: P. Frank	<p>TAOGLAS <small>TW Design Center</small></p> <p><small>This drawing and its inherent design concepts are property of Taoglas, not to be copied or given to third parties without the written consent of Taoglas.</small></p>
CHECK BY: J. Campbell	
DRAWN BY: G. Samson	
DATE: 1/27/2022	
<small>UNLESS OTHERWISE SPECIFIED</small> <small>TOLERANCES ON:</small> <small>3X.403</small> <small>3.403</small> <small>3.401</small> <small>3.00±0.05</small>	
<small>THIRD ANGLE PROJECTION</small>	TITLE: GNSS Front End Module Evaluation Board L1+B1+G1/L5 PART NO.: TFMD.100B UNIT: mm SCALE: 1:1 PAGES: 1/1 REV: 001

7. Module Integration

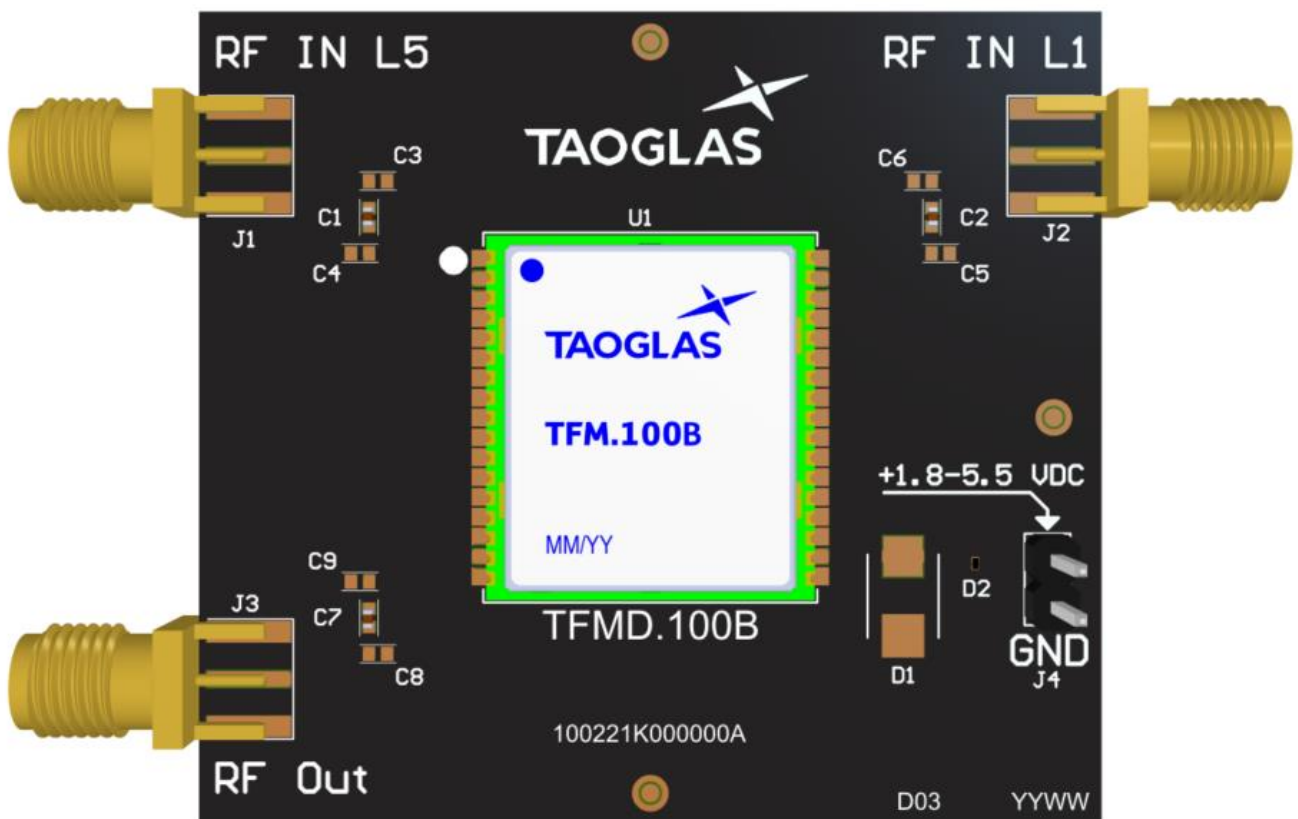

7.1 Schematic Symbol and Pin Definitions

The circuit symbol for the TFM.100A is shown below. The front-end module has 34 pins as indicated below.

Pin	Description
1, 3-15, 17-18, 20-32, 34	Ground
2	L5 Input
16	Signal Output
19	Voltage Input
33	L1 Input

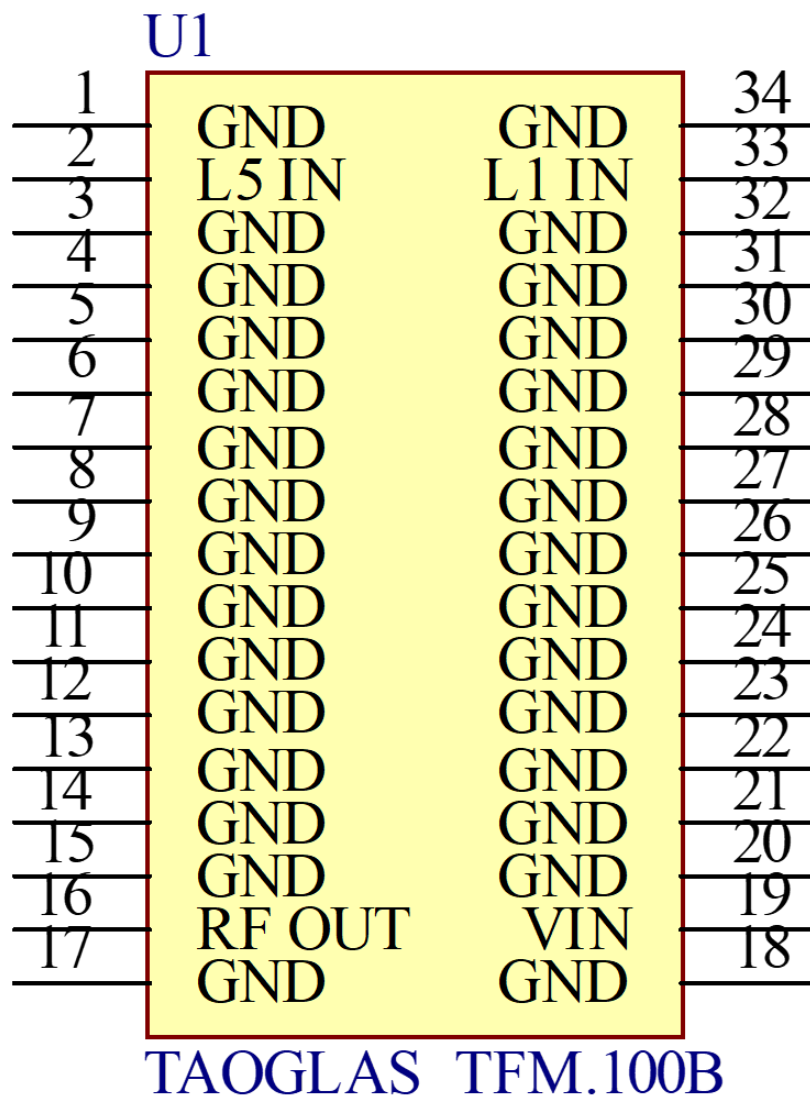

7.2 Module Integration

The TFM.100B should be placed as close to the signal input and output as possible to shorten the length of the transmission lines. The RF IN/OUT traces must maintain a 50 Ohm transmission line. A Pi Matching Network is recommended for the RF IN transmission lines, the values and components for the matching circuit will depend on the tuning needed. Ground vias should be placed beside each ground pad and the DC Voltage input should be between +1.8 & +5.5 VDC. It's recommended that the DC Voltage input should be coupled with a 100pF Capacitor and an ESD Diode.

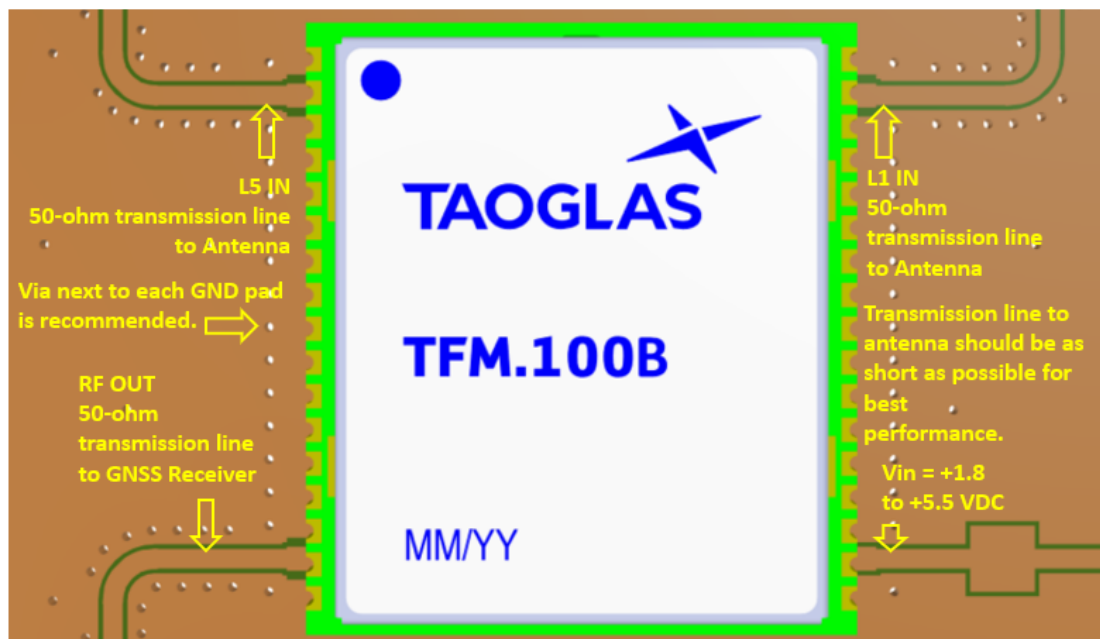

Top Side w/o Solder Mask

7.3 PCB Clearance

The footprint and clearance on the PCB must comply with the front-end module's specification. The PCB layout shown in the diagram below demonstrates the TFM.100B clearance area for Pin 16 (RF OUT Pad) & Pin 33 (L1 IN Pad). This clearance also applies to Pin 2 (L5 IN Pad). The copper keep out area only applies to the same layer the TFM.100B was placed.

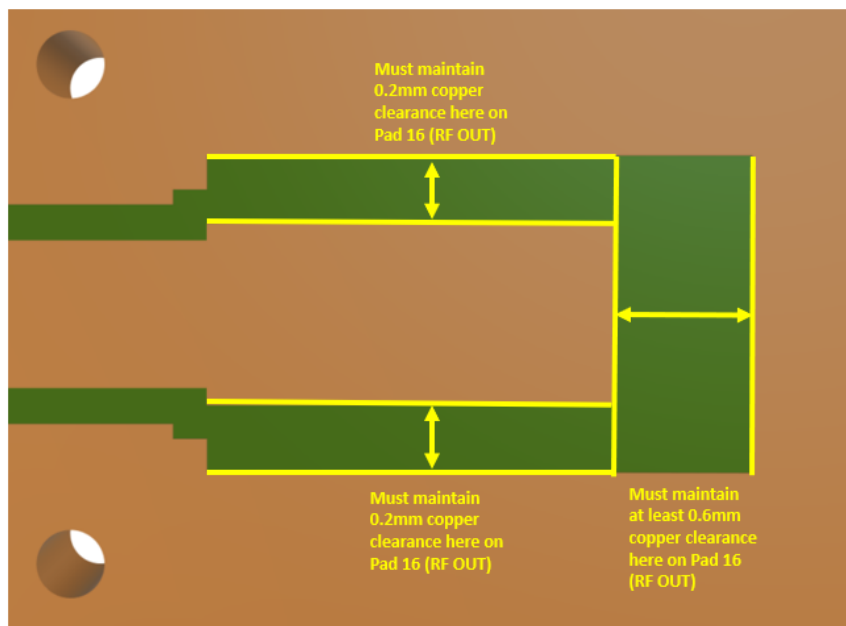

Pin 16 (RF OUT Pad)

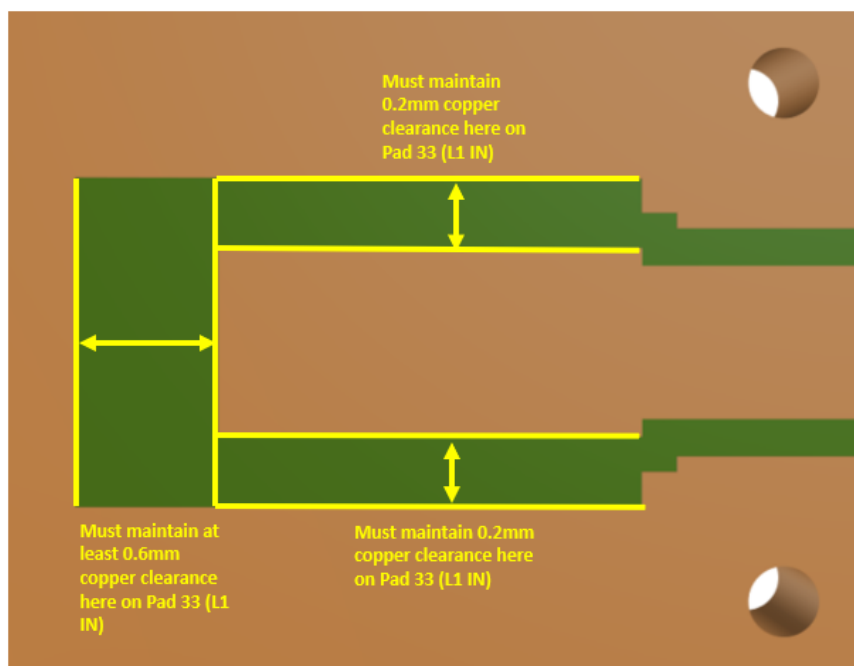

Pin 33 (L1 IN Pad)

7.4 PCB Layout

The footprint and clearance on the PCB must comply with the module specification. The PCB layout shown in the diagram below demonstrates the module footprint.

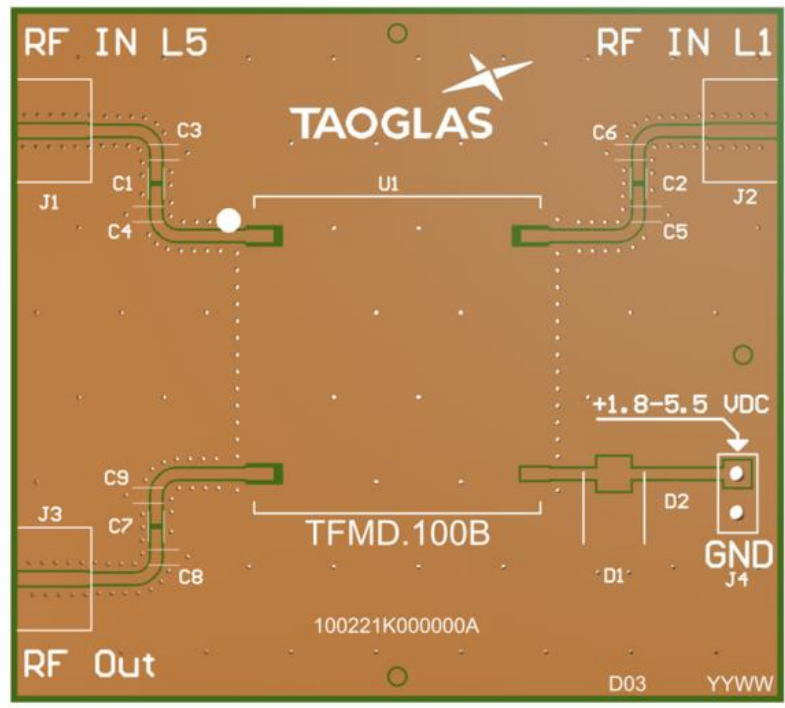

Topside

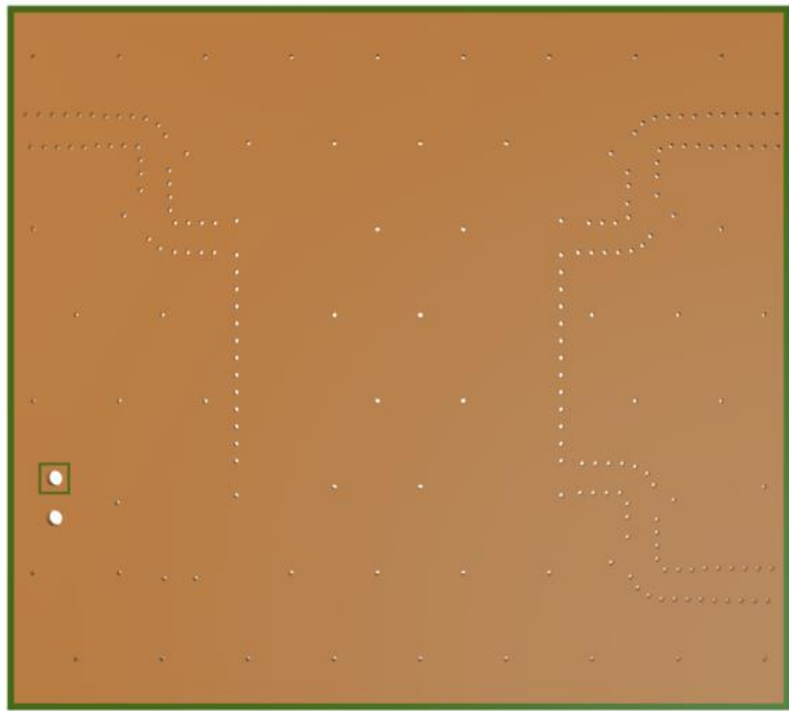

Bottom Side

7.5 Evaluation Board

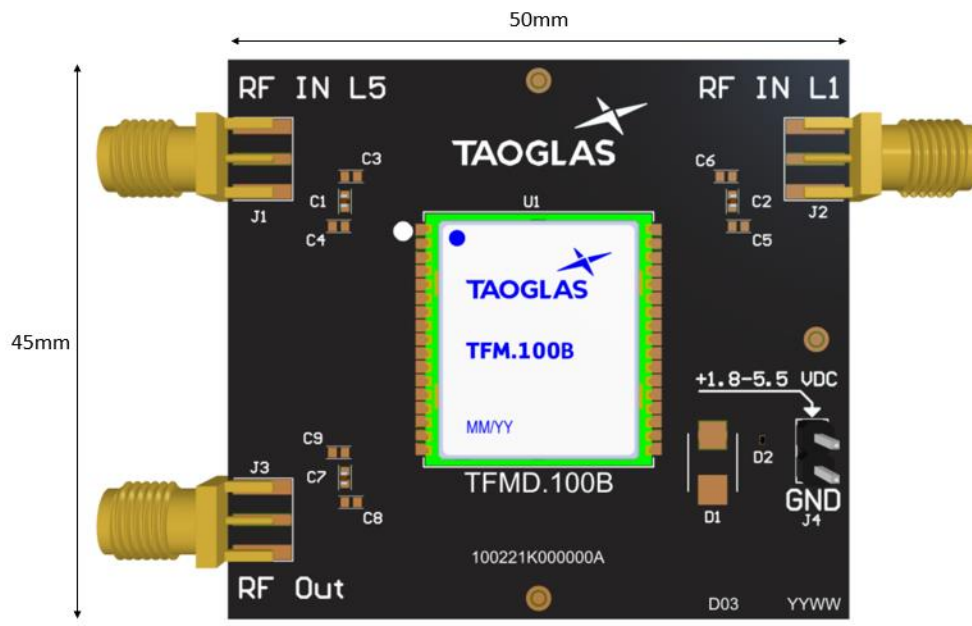

Topside



Bottom Side

7.6 Demonstration Board



7.7 Demonstration Board Layout

The footprint and clearance on the PCB must comply with the module specification. The PCB layout shown in the diagram below demonstrates the module footprint.



Topside

7.8 Demonstration Board

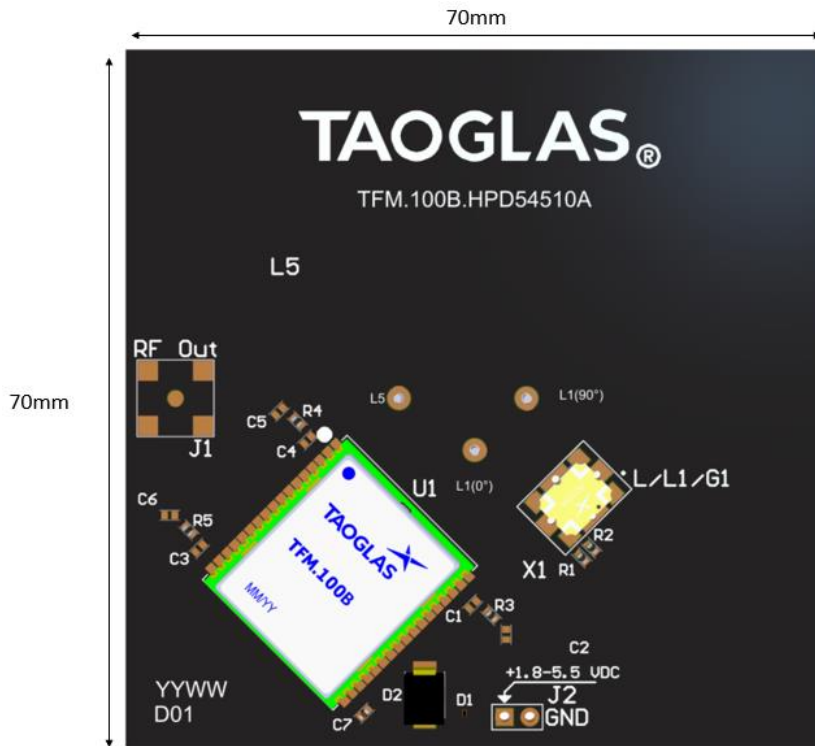

Topside

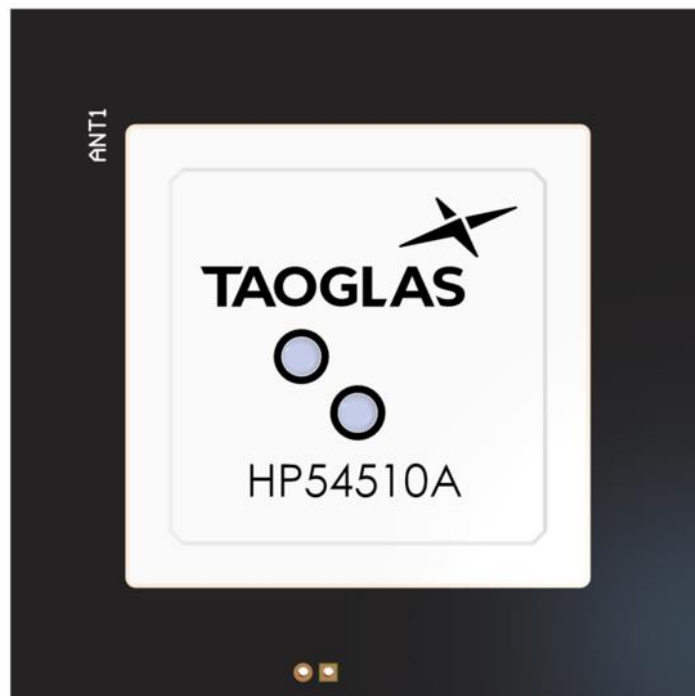

Bottom Side

8. Solder Reflow Recommendations

The TFM.120B can be assembled by following the recommended soldering temperatures are as follows:

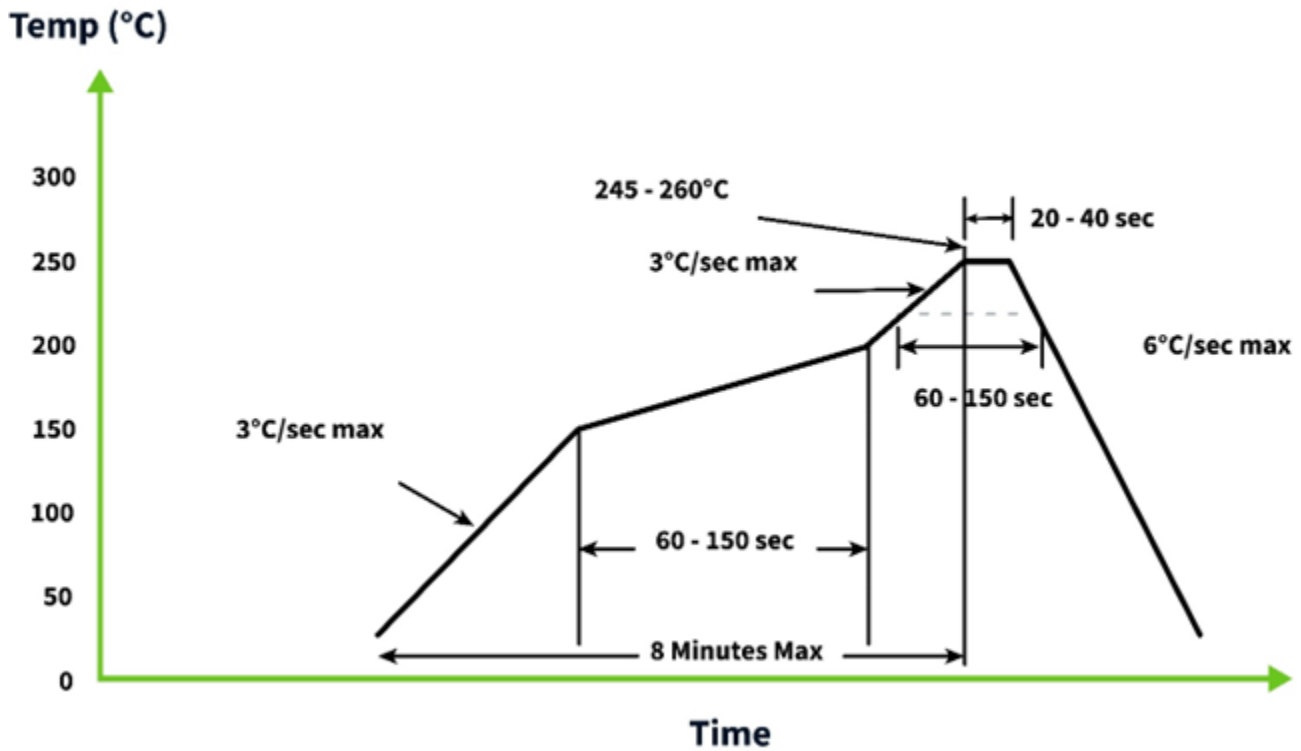

The TFM.120B is limited to X number of passes through the reflow process. Smaller components are typically mounted on the first pass, however, we do advise mounting the TFM.120B when placing larger components on the board during subsequent reflows.

9. Packaging

600 PCS / Reel
SPQ Label



600 PCS / Vacuum bag
2 PCS / 3g Desiccant
1 PCS / Humidity test paper
SPQ Label

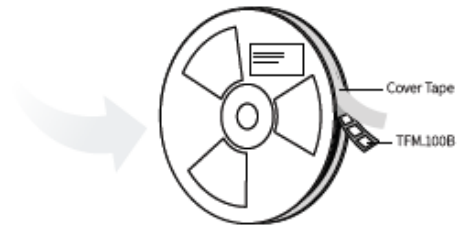

Caution Label
Product Label
SPQ Label



1 PCS / Box
Box(mm): 350x340x67
Weight (Kg): 2
SPQ Label

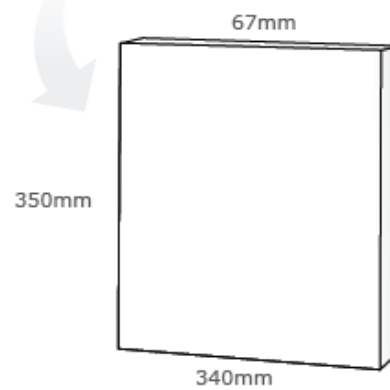

2400 PCS / Carton
Carton(mm): 370x370x300
Weight (Kg): 8.8
Carton Label

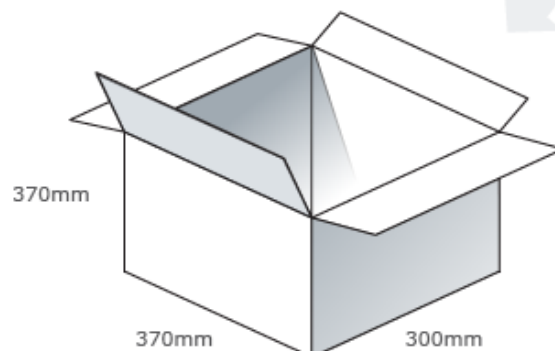

Changelog for the datasheet

SPE-23-8-125 – TFM.100B

Revision: A (Original First Release)

Date: 2023-05-08

Notes: Initial Release

Author: Gary West

Previous Revisions
