



TAOGLAS®



Datasheet

Part No:
TG.30.8111

Features:

600-6000MHz Operational
Wideband Cellular 5G/4G
Typical 70%+ Efficiency and 3dBi+ Peak Gain
Dipole Straight Terminal Antenna
Straight SMA(M) Connector
RoHS and REACH Compliant

1.	Introduction	2
2.	Specification	3
3.	Antenna Characteristics	6
4.	Radiation Patterns	8
5.	Mechanical Drawing	42
6.	Packaging	43
<hr/>		
	Changelog	44

Taoglas makes no warranties based on the accuracy or completeness of the contents of this document and reserves the right to make changes to specifications and product descriptions at any time without notice. Taoglas reserves all rights to this document and the information contained herein. Reproduction, use or disclosure to third parties without express permission is strictly prohibited.



1. Introduction



The Apex TG.30 Ultra-Wideband Dipole LTE Antenna – is primarily designed for use with 5G/4G modules and devices that require the highest possible efficiency and peak gain to deliver best in class throughput on all major cellular (5G/4G) bands worldwide for access points, terminals and routers. The antenna is a ground plane independent antenna with a SMA (M) connector.

The Apex exhibits high efficiency across the wide band and is backward compatible with 2G and 3G cellular applications such as GSM, LTE, UMTS, WI-FI and even has GPS included for Assisted GPS and/or E911 applications. With very high efficiency on every cellular band globally it is an ideal solution for any device requiring high, reliable performance. It is also guaranteed to meet any type approval or carrier certification requirements from a RF standpoint. It is an omni-directional antenna and the radiation patterns display this and are stable across all bands.

Typical Applications Include:

- Gateways and Routers
- Smart Metering
- Payment Terminals

It has a quality robust UV resistant housing for use with wireless terminals. This patented antenna is available in black and white versions. It is also available with hinged and right angle connectors. The connector can be changed subject to NRE or MOQ. For further information please contact your regional Taoglas customer support team.

2. Specification

LTE Electrical									
Band	Frequency (MHz)	Measurement	Efficiency (%)	Average Gain (dB)	Peak Gain (dBi)	Impedance	Polarization	Radiation Pattern	VSWR
5GNR/4G Band 5,8,12,13,14,17,18,20,26,27,28,29,71	617-960	30X30cm Ground plane (Centre)	56.9	-2.45	1.98	50 Ω	Linear	Omni	3 MAX
		Free space	54.8	-2.62	3.00				
		30X30cm Ground plane (Edge)	53.5	-2.72	2.66				
5GNR/4G Band 21,32,74,75,76	1427-1518	30X30cm Ground plane (Centre)	54.6	-2.63	5.94				
		Free space	49.8	-3.02	4.81				
		30X30cm Ground plane (Edge)	65.3	-1.85	3.10				
4G/3G Band 1,2,3,4,9,23,25,35,39,66	1710-2200	30X30cm Ground plane (Centre)	70.8	-1.50	3.18				
		Free space	78.3	-1.06	4.03				
		30X30cm Ground plane (Edge)	67.8	-1.69	3.91				
4G/3G Band 40	2300-2400	30X30cm Ground plane (Centre)	61.5	-2.11	3.75				
		Free space	75.0	-1.25	4.01				
		30X30cm Ground plane (Edge)	67.0	-1.74	3.63				
Wi-Fi 2400	2400-2500	30X30cm Ground plane (Centre)	31.9	-4.96	2.49				
		Free space	63.1	-2.00	3.32				
		30X30cm Ground plane (Edge)	59.3	-2.27	3.42				
4G/3G Band 7,38,41	2490-2690	30X30cm Ground plane (Centre)	38.3	-4.17	7.15				
		Free space	61.4	-2.12	4.73				
		30X30cm Ground plane (Edge)	48.5	-3.15	4.67				
5GNR/4G Band 22,42,43,48,77,78	3300-3800	30X30cm Ground plane (Centre)	34.0	-4.69	5.17				
		Free space	42.4	-3.73	4.84				
		30X30cm Ground plane (Edge)	36.8	-4.34	4.20				
LTE5200/ Wi-Fi 5800	5150-5925	30X30cm Ground plane (Centre)	41.2	-3.85	8.37				
		Free space	61.8	-2.09	6.52				
		30X30cm Ground plane (Edge)	41.3	-3.84	4.34				

Mechanical

Casing	UV Resistant PC/ABS
Flammability Rating	UL-94
Connector	SMA Male Straight

Environmental

Temperature Range	-40°C to 85°C
Humidity	Non-condensing 65°C 95% RH

5G/4G Bands					
Band Number	5GNR / FR1 / LTE / LTE-Advanced / WCDMA / HSPA / HSPA+ / TD-SCDMA				
	Uplink	Downlink	30X30cm Ground plane (Centre)	Free space	30X30cm Ground plane
B1	1920 to 1980	2110 to 2170	✓	✓	✓
B2	1850 to 1910	1930 to 1990	✓	✓	✓
B3	1710 to 1785	1805 to 1880	✓	✓	✓
B4	1710 to 1755	2110 to 2155	✓	✓	✓
B5	824 to 849	869 to 894	✓	✓	✓
B7	2500 to 2570	2620 to 2690	✓	✓	✓
B8	880 to 915	925 to 960	✓	✓	✓
B9*	1749.9 to 1784.9	1844.9 to 1879.9	✓	✓	✓
B11	1427.9 to 1447.9	1475.9 to 1495.9	✗	✓	✓
B12	699 to 716	729 to 746	✓	✓	✓
B13	777 to 787	746 to 756	✓	✓	✓
B14	788 to 798	758 to 768	✓	✓	✓
B17	704 to 716	734 to 746	✓	✓	✓
B18	815 to 830	860 to 875	✓	✓	✓
B19	830 to 845	875 to 890	✓	✓	✓
B20	832 to 862	791 to 821	✓	✓	✓
B21	1447.9 to 1462.9	1495.9 to 1510.9	✓	✓	✓
B22*	3410 to 3490	3510 to 3590	✓	✓	✓
B23*	2000 to 2020	2180 to 2200	✓	✓	✓
B24	1626.5 to 1660.5	1525 to 1559	✓	✓	✓
B25	1850 to 1915	1930 to 1995	✓	✓	✓
B26	814 to 849	859 to 894	✓	✓	✓
B27*	807 to 824	852 to 869	✓	✓	✓
B28	703 to 748	758 to 803	✓	✓	✓
B29		717 to 728	✓	✓	✓
B30	2305 to 2315	2350 to 2360	✓	✓	✓
B31	452.5 to 457.5	462.5 to 467.5	✗	✗	✗
B32		1452 to 1496	✓	✓	✓
B34		2010 to 2025	✓	✓	✓
B35		1850 to 1910	✓	✓	✓
B36		1930 to 1990	✓	✓	✓
B37		1910 to 1930	✓	✓	✓
B38		2570 to 2620	✓	✓	✓
B39		1880 to 1920	✓	✓	✓
B40		2300 to 2400	✓	✓	✓
B41		2496 to 2690	✓	✓	✓
B42		3400 to 3600	✓	✓	✓
B43		3600 to 3800	✓	✓	✓
B45		1447 to 1467	✓	✓	✓
B46		5150 to 5925	✓	✓	✓
B47		5855 to 5925	✓	✓	✓
B48		3550 to 3700	✓	✓	✓
B49		3550 to 3700	✓	✓	✓
B50		1432 to 1517	✓	✓	✓
B51		1427 to 1432	✗	✓	✓
B52		3300 to 3400	✗	✓	✗
B53		2483.5 to 2495	✓	✓	✓
B65	1920 to 2010	2110 to 2200	✓	✓	✓
B66	1710 to 1780	2110 to 2200	✓	✓	✓
B68	698 to 728	753 to 783	✓	✓	✓
B69		2570 to 2620	✓	✓	✓
B70	1695 to 1710	1995 to 2020	✓	✓	✓
B71	663 to 698	617 to 652	✗	✗	✗
B72	451 to 456	461 to 466	✗	✗	✗
B73	450 to 455	460 to 465	✗	✗	✗
B74	1427 to 1470	1475 to 1518	✓	✓	✓
B75		1432 to 1517	✓	✓	✓
B76		1427 to 1432	✗	✓	✓
B77		3300 to 4200	✓	✓	✓
B78		3300 to 3800	✓	✓	✓
B79		4400 to 5000	✓	✓	✓
B85	698 to 716	728 to 746	✓	✓	✓
B87	410 to 415	420 to 425	✗	✗	✗
B88	412 to 417	422 to 427	✗	✗	✗

3. Antenna Characteristics

3.1 Return Loss

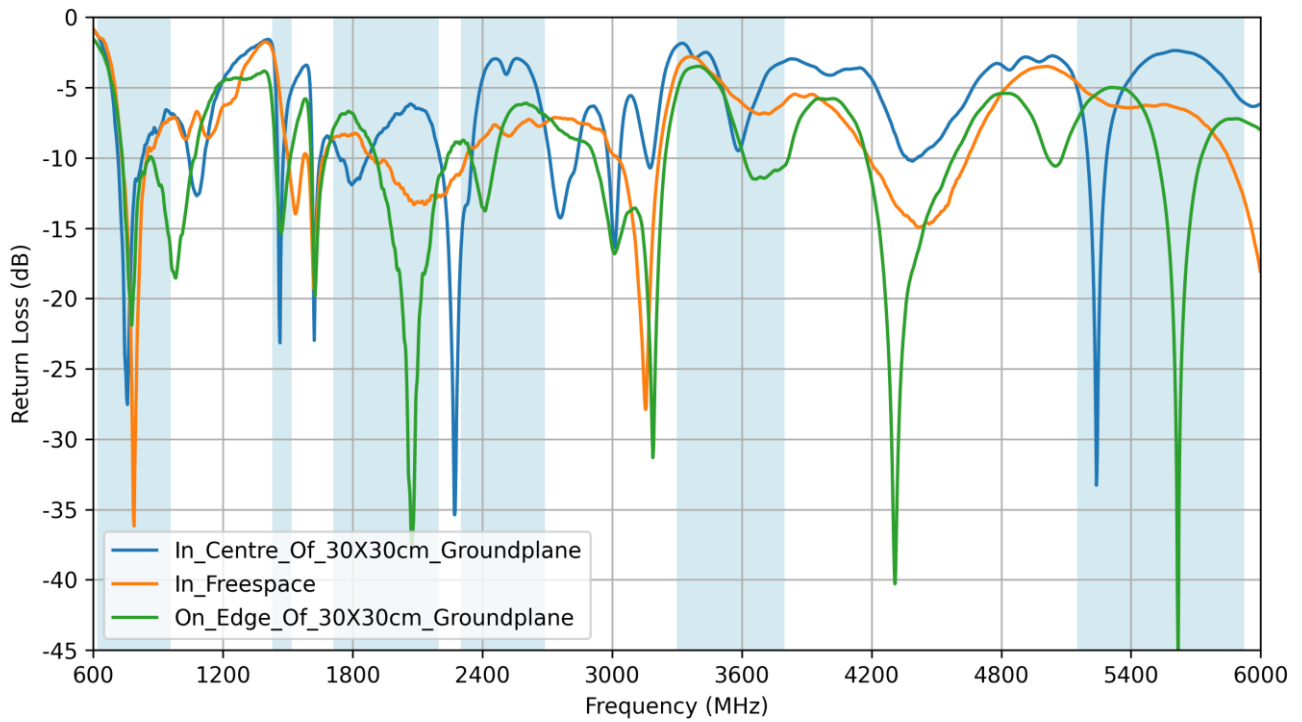

3.2 Efficiency

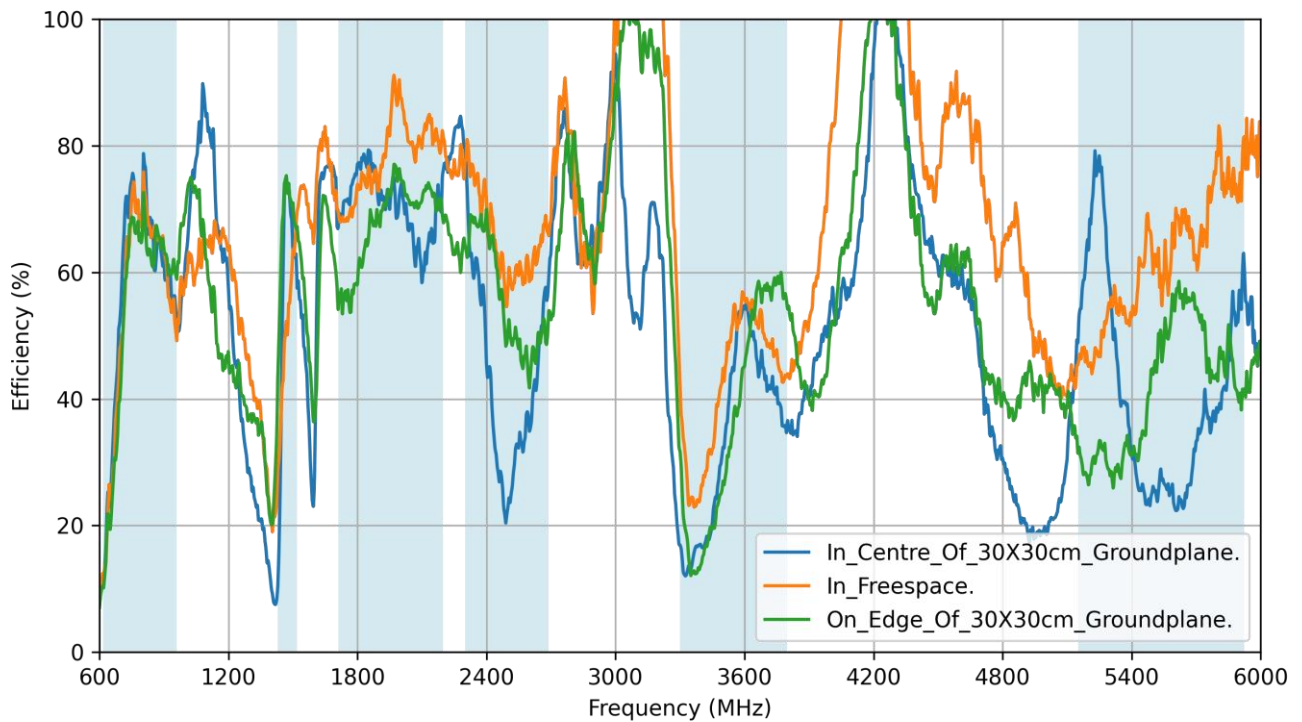

3.3 Average Gain

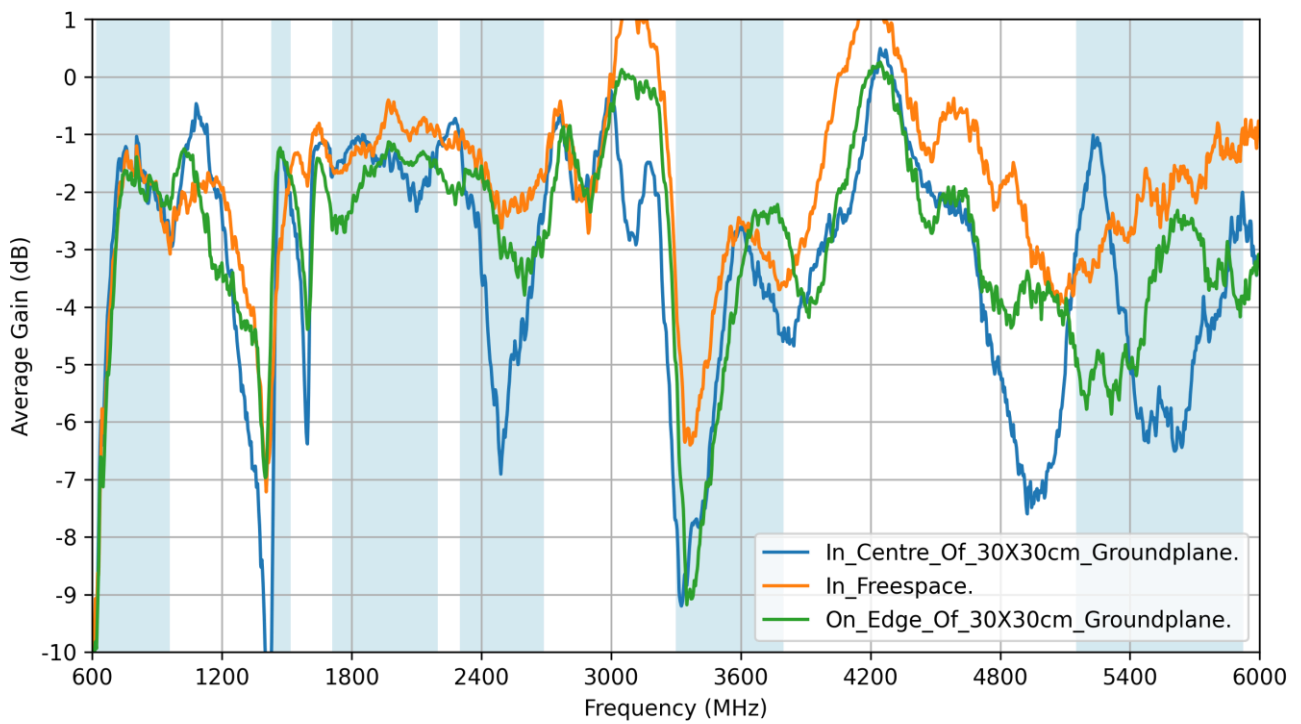

3.4 Peak Gain

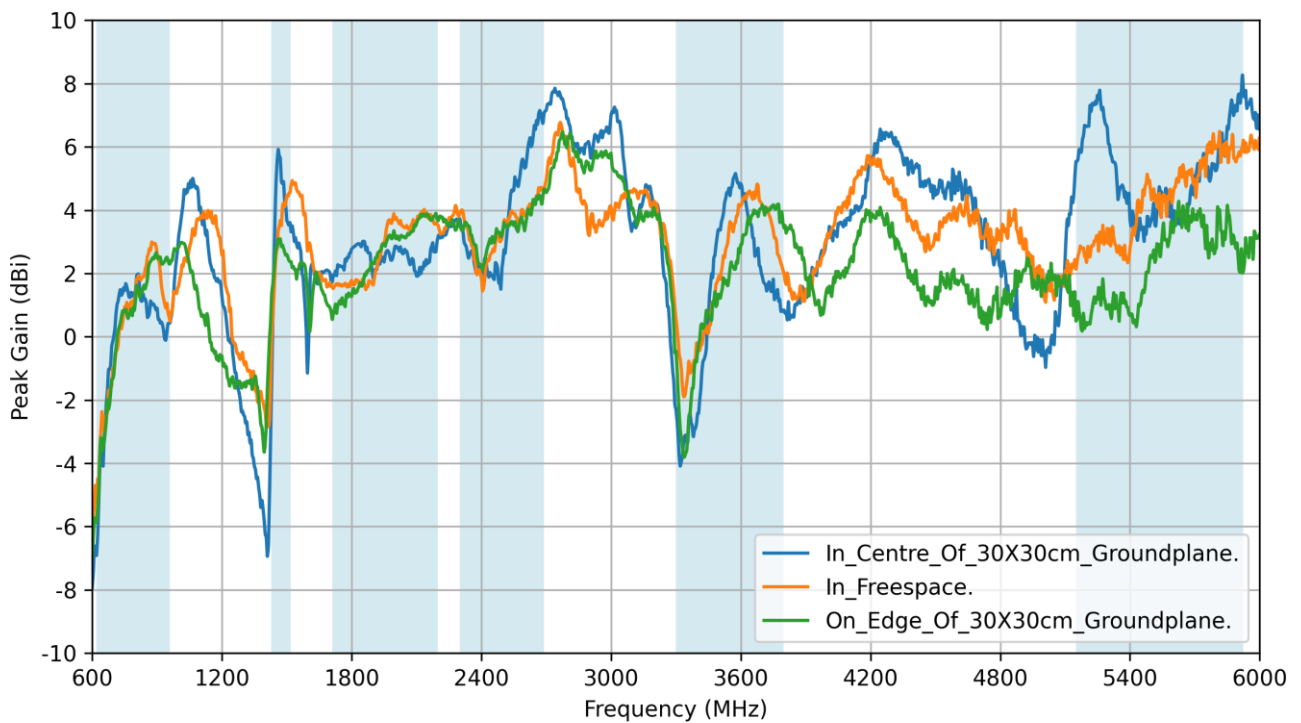

4. Radiation Patterns

4.1 Test Setup

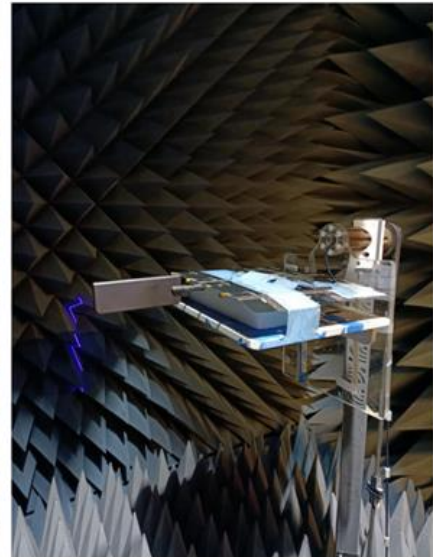
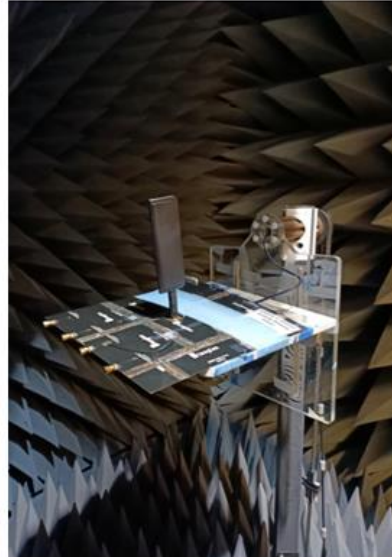
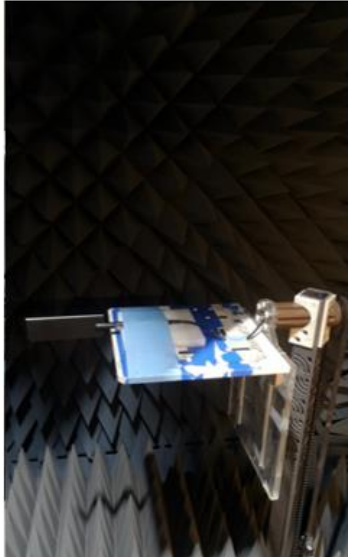
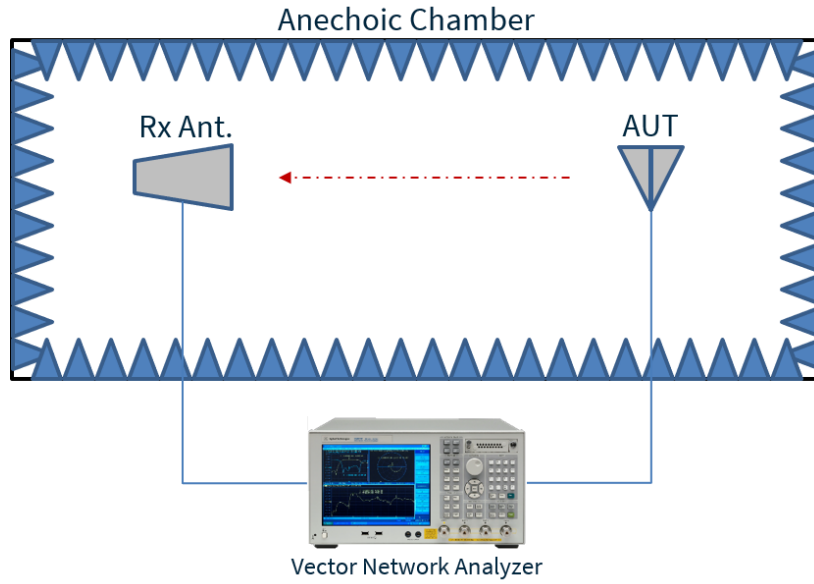

4.2 30x30cm Ground plane (Centre) - Patterns at 650 MHz

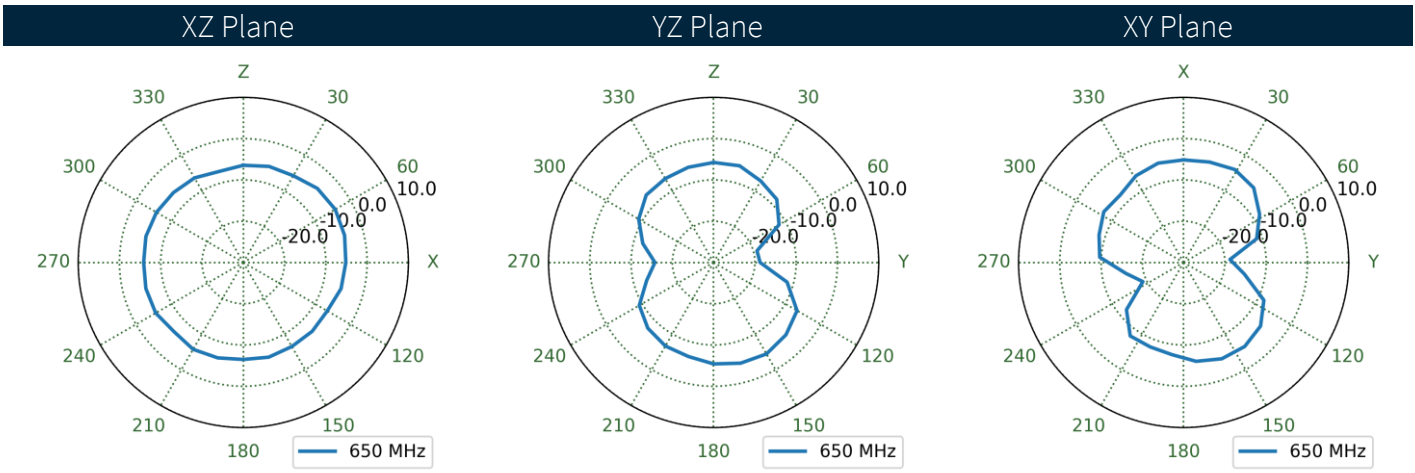
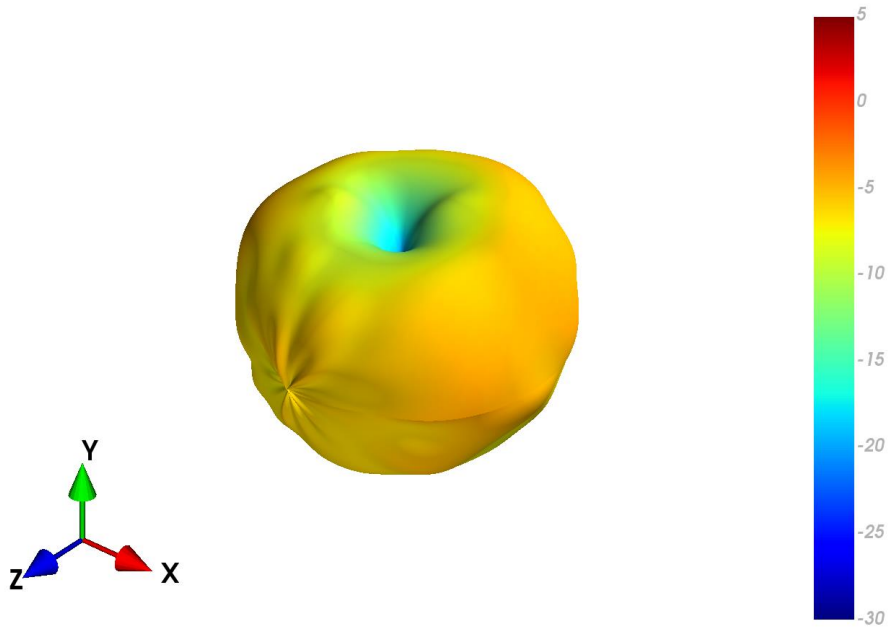

4.3 Free space - Patterns at 650 MHz

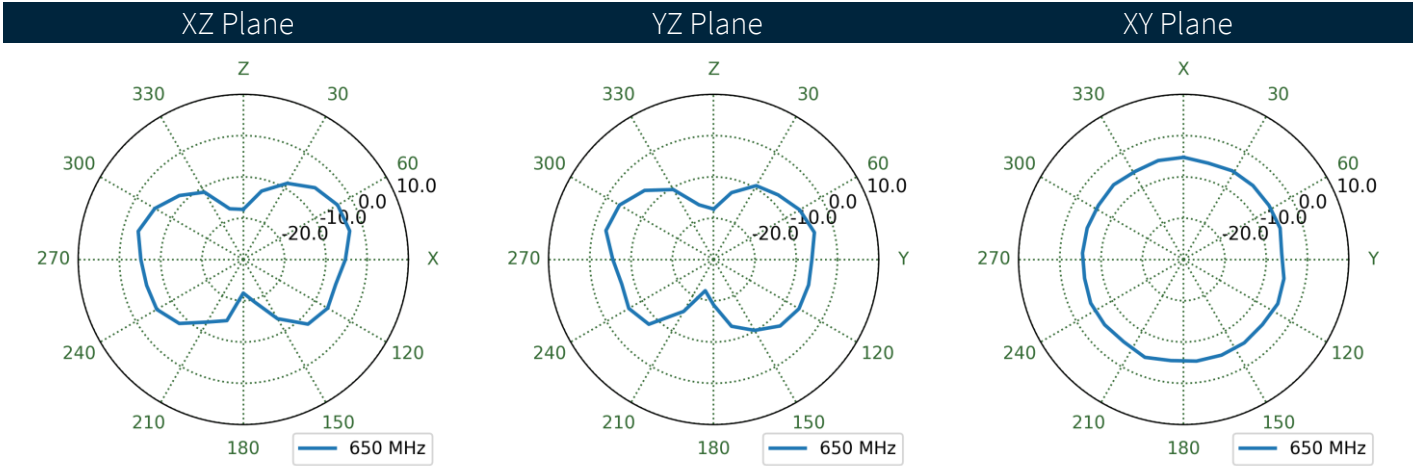
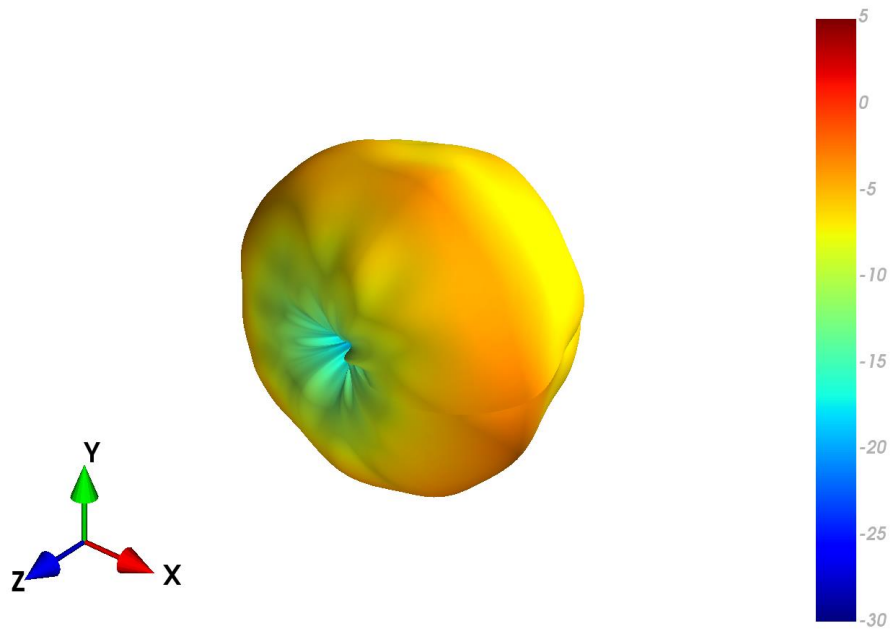

4.4 30x30cm Ground plane (Edge) - Patterns at 650 MHz

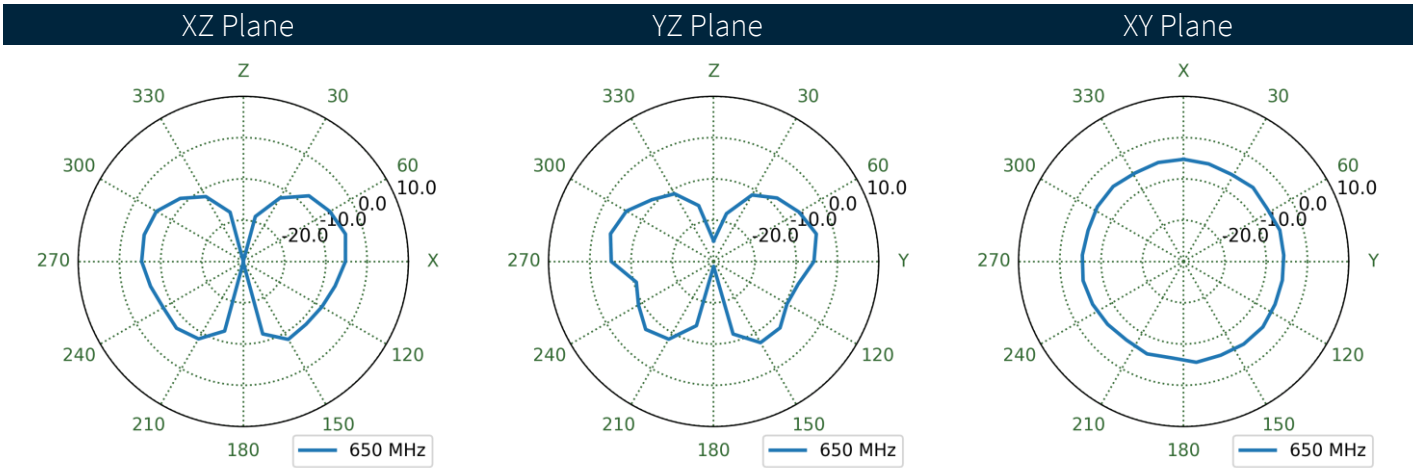
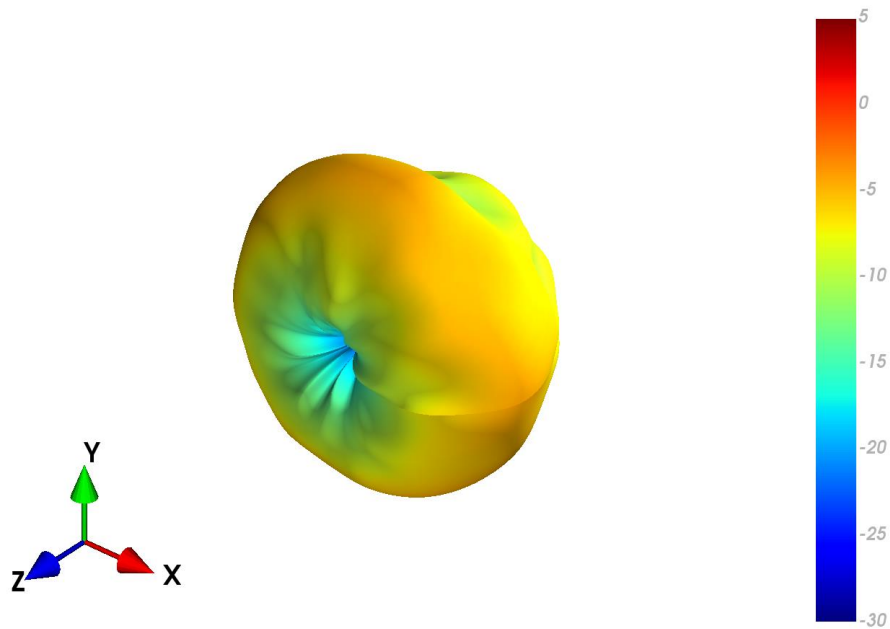

4.5 30x30cm Ground plane (Centre) - Patterns at 750 MHz

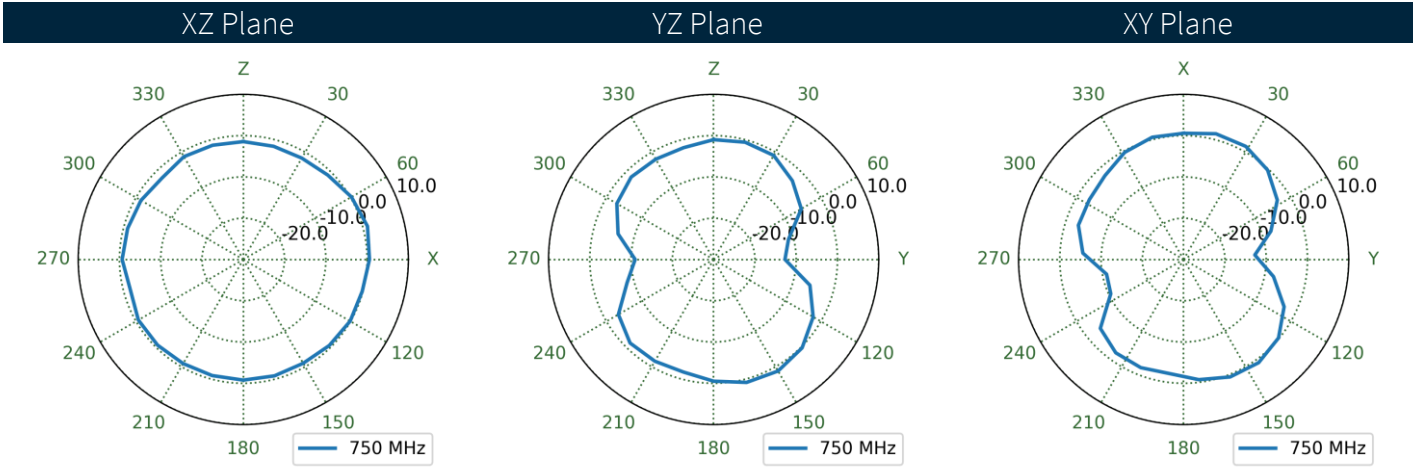
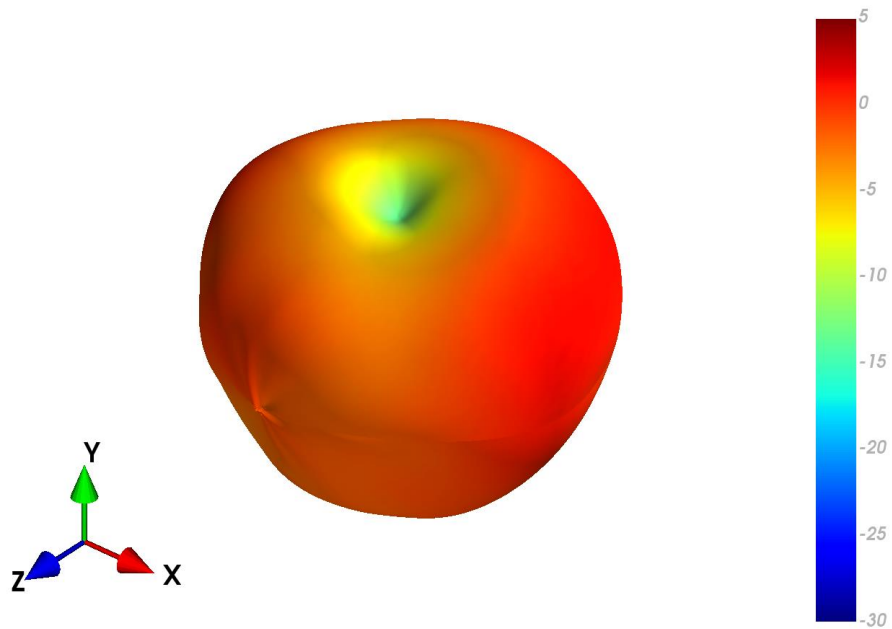

4.6 Free space - Patterns at 750 MHz

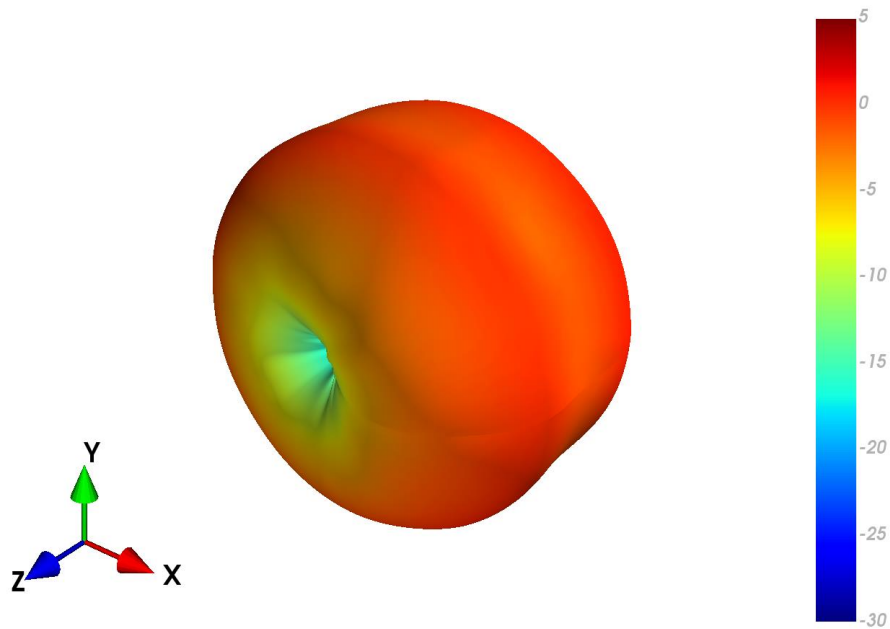

XZ Plane YZ Plane XY Plane

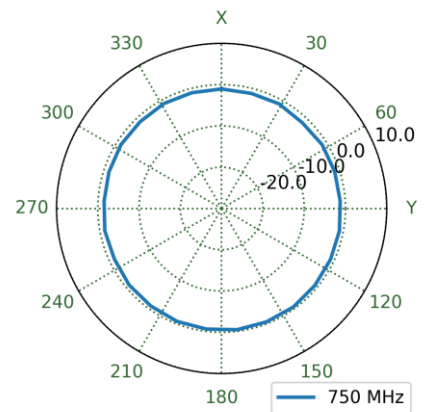
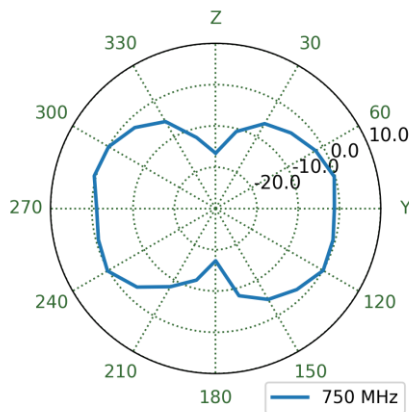
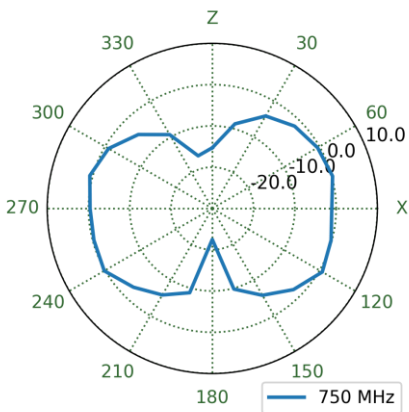

4.7 30x30cm Ground plane (Edge) - Patterns at 750 MHz

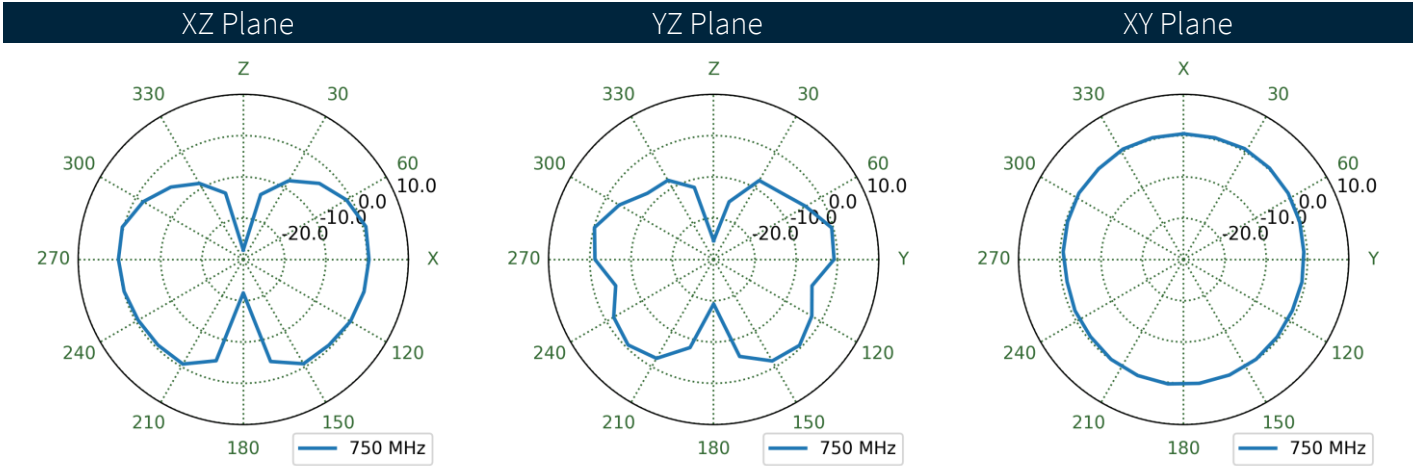
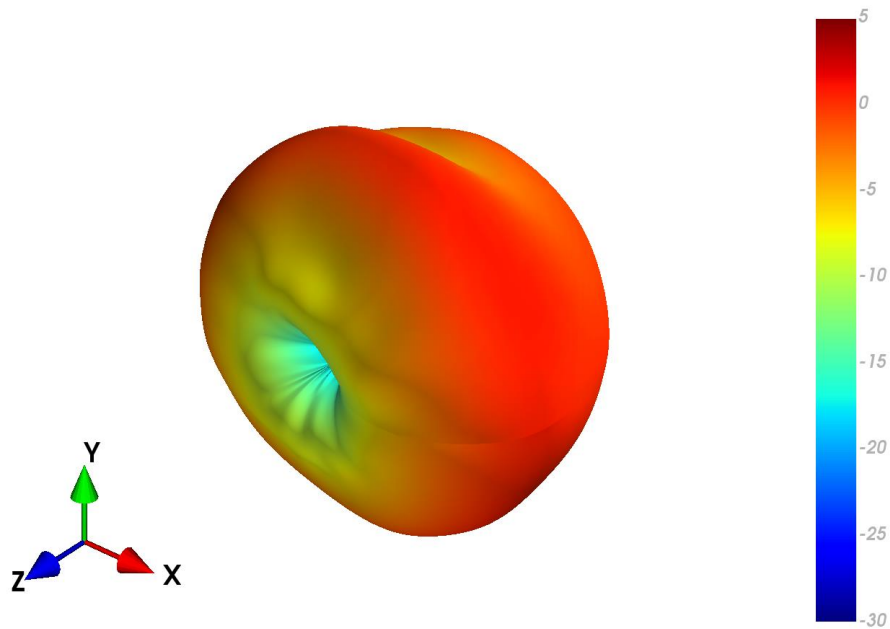

4.8 30x30cm Ground plane (Centre) - Patterns at 890 MHz

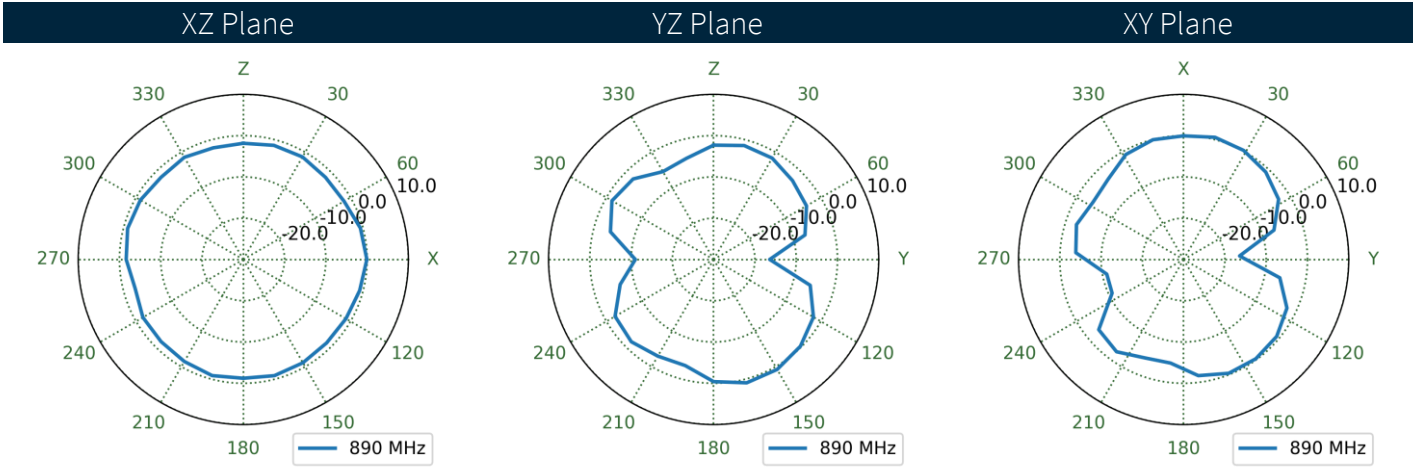
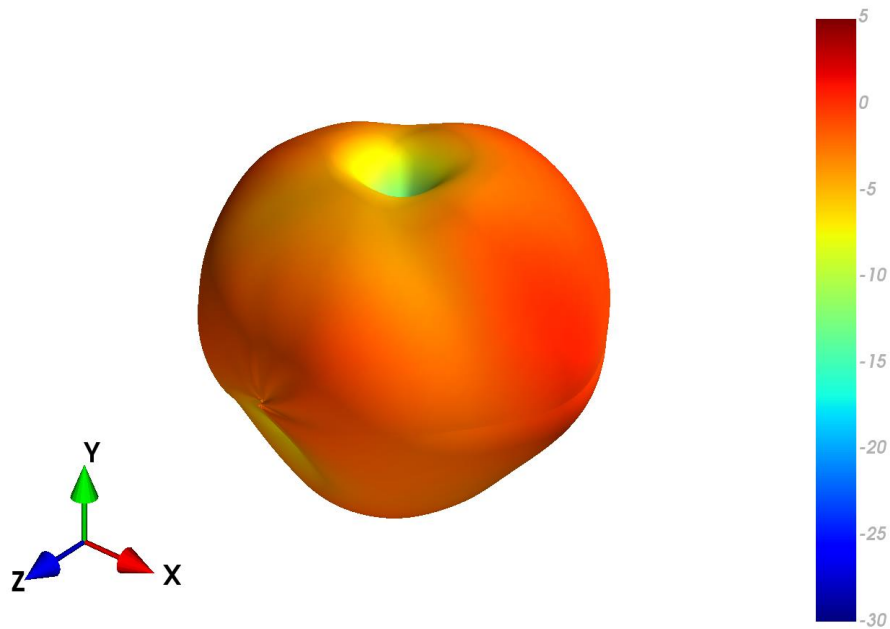

4.9 Free space - Patterns at 890 MHz

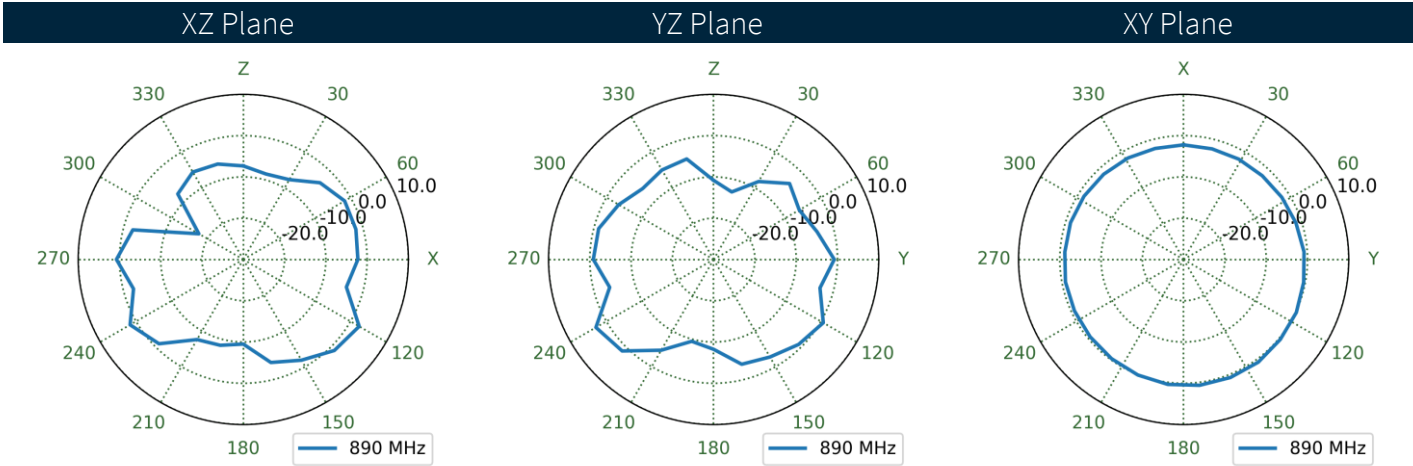
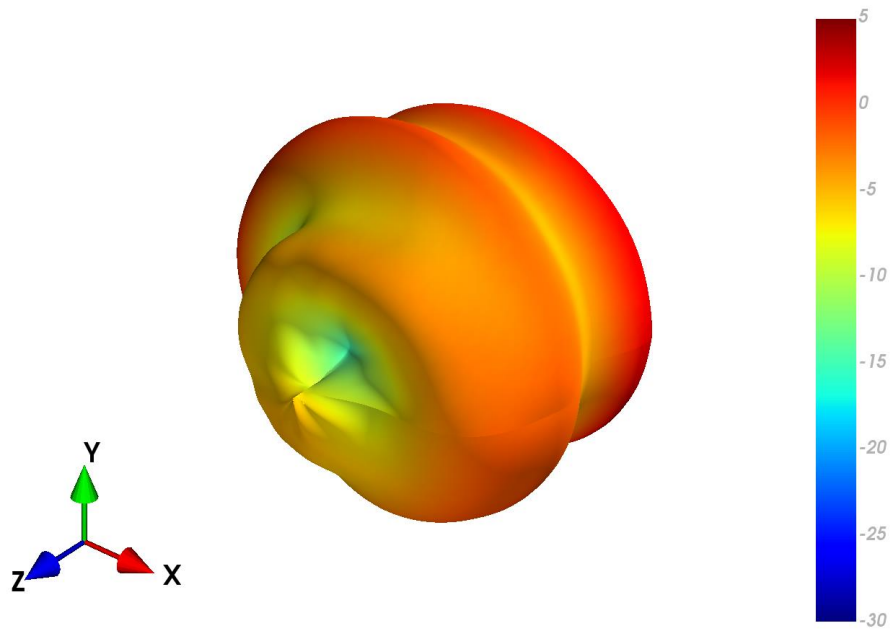

4.10 30x30cm Ground plane (Edge) - Patterns at 890 MHz

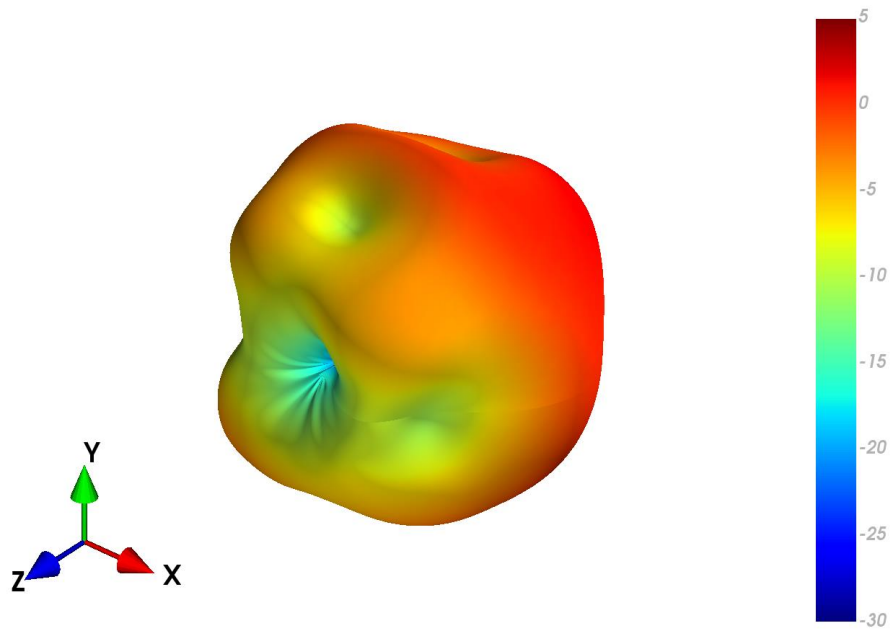

XZ Plane YZ Plane XY Plane

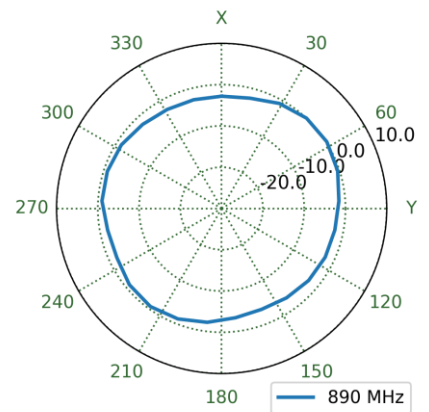
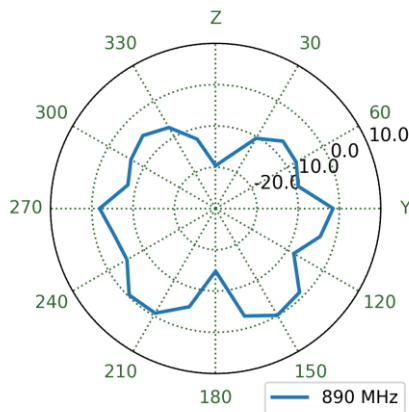
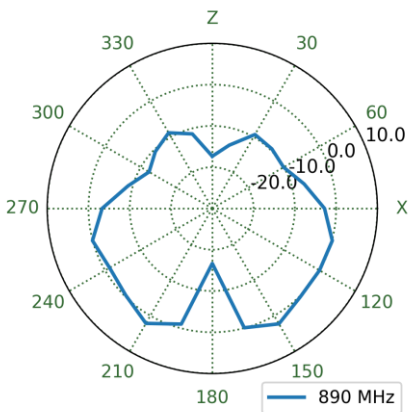

4.11 30x30cm Ground plane (Centre) - Patterns at 960 MHz

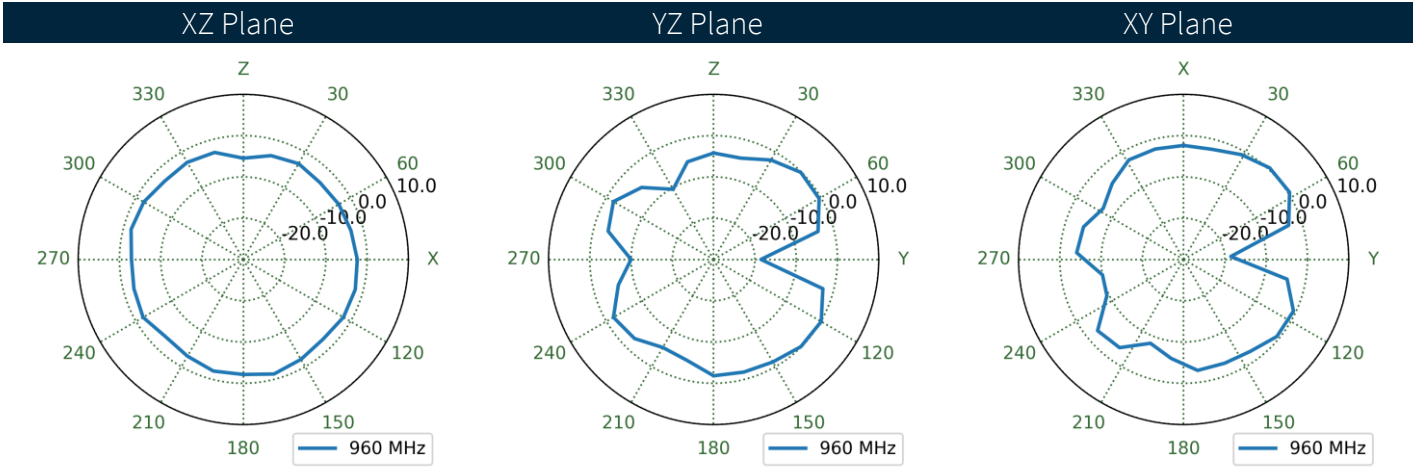
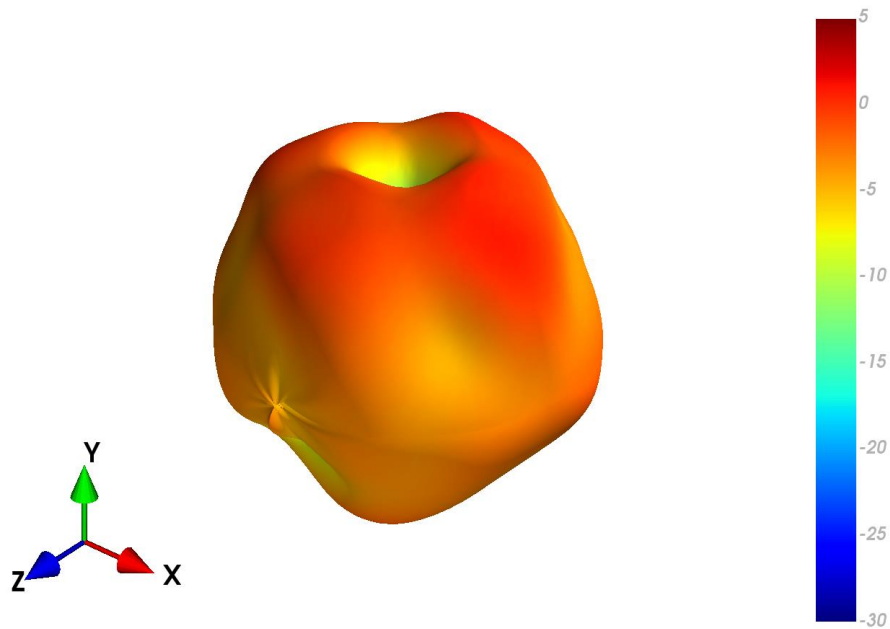

4.12 Free space - Patterns at 960 MHz

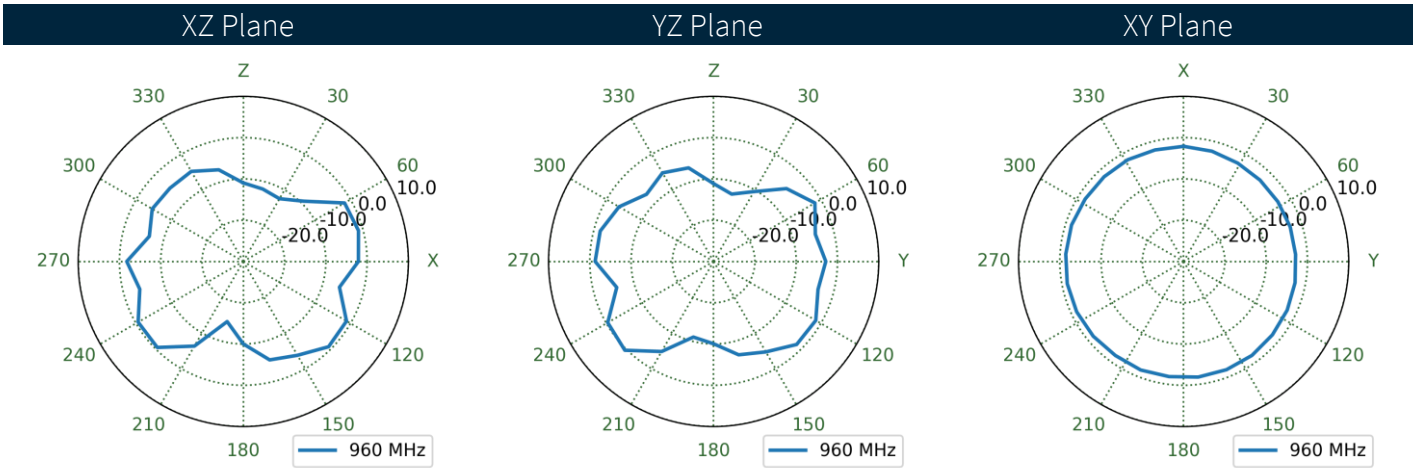
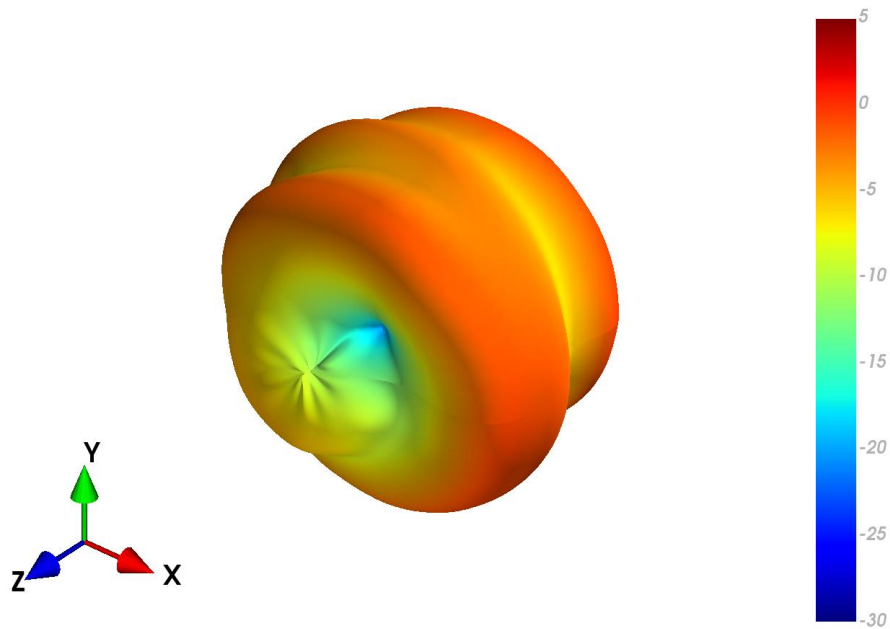

4.13 30x30cm Ground plane (Edge) - Patterns at 960 MHz

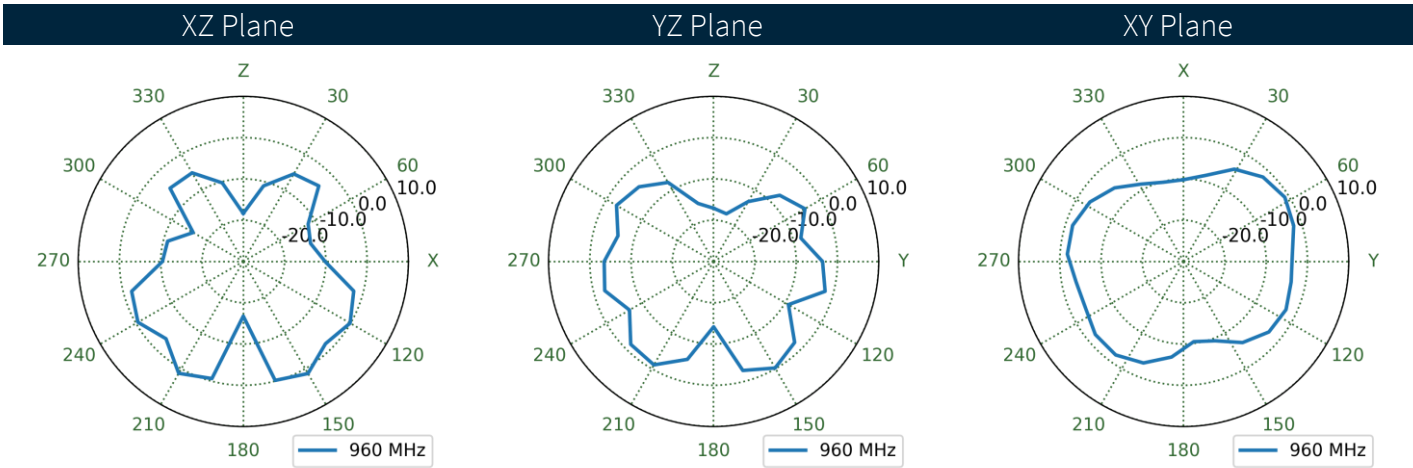
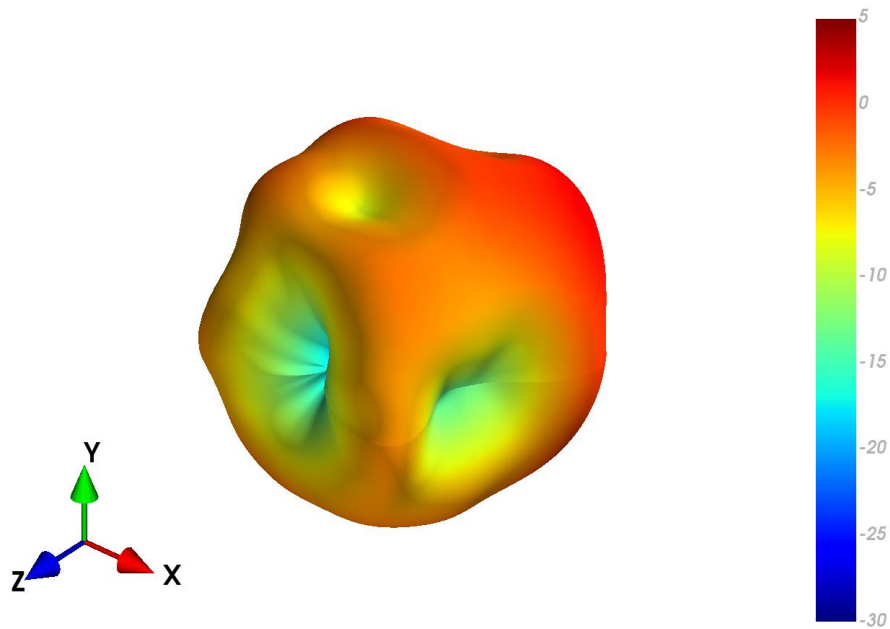

4.14 30x30cm Ground plane (Centre) - Patterns at 1470 MHz

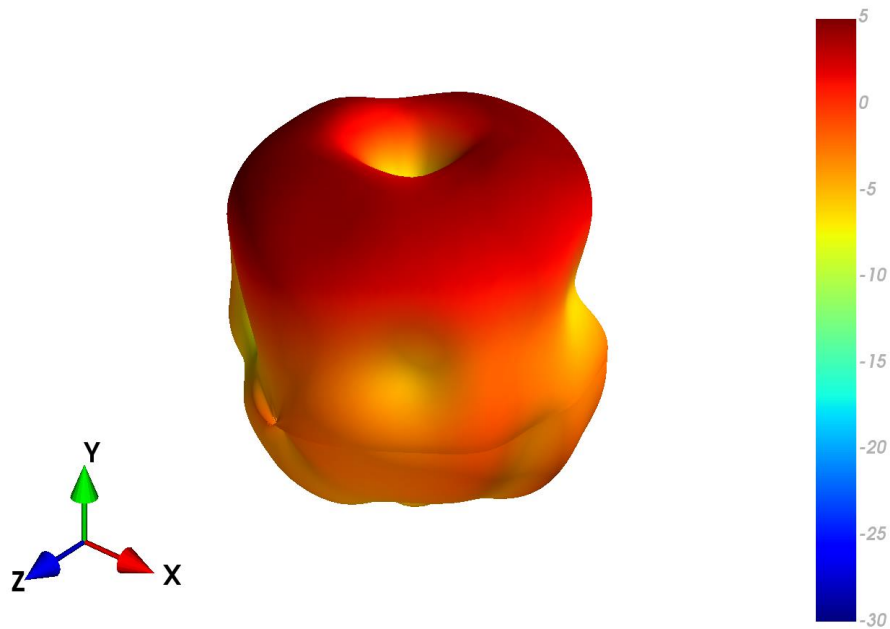

XZ Plane YZ Plane XY Plane

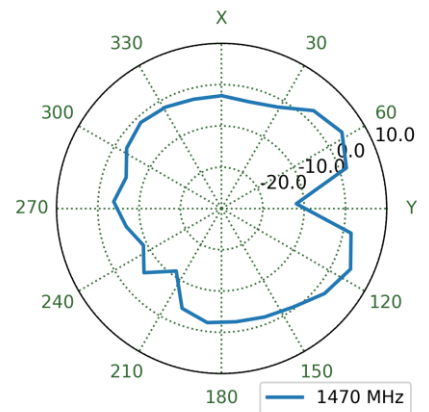
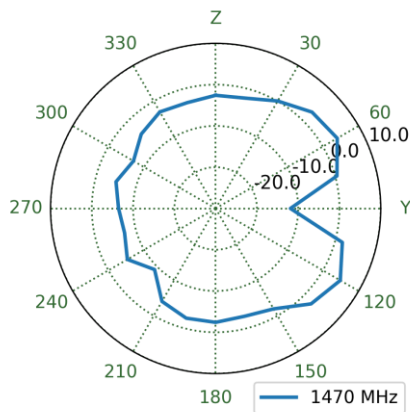
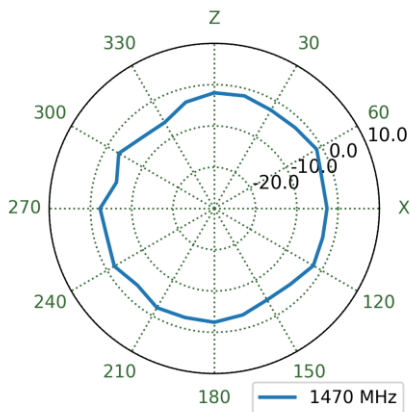

4.15 Free space - Patterns at 1470 MHz

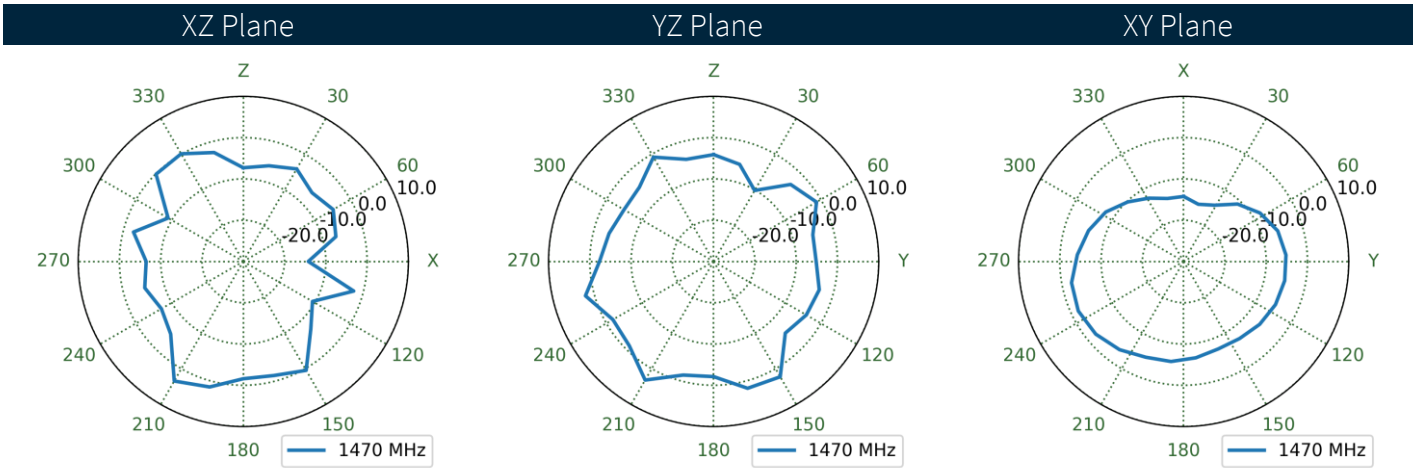
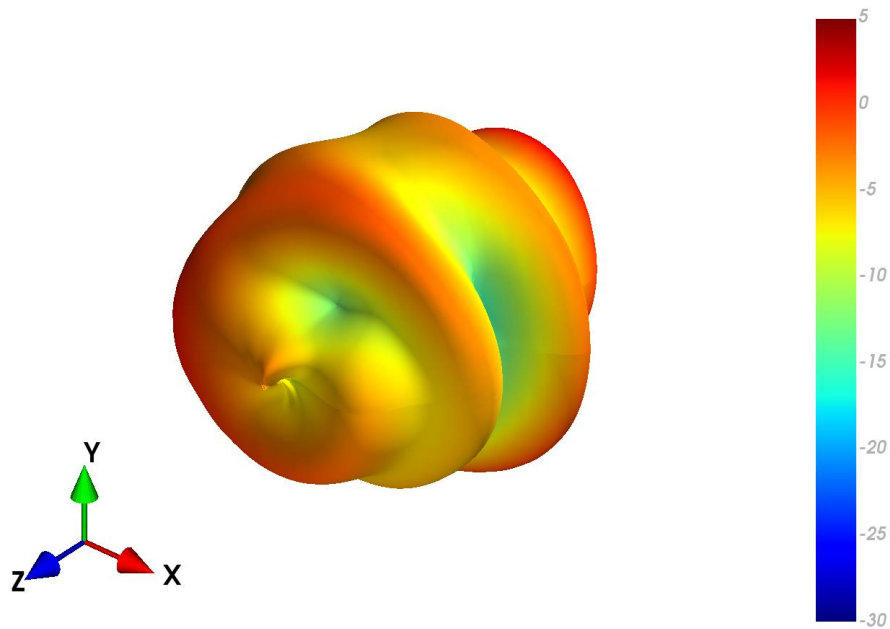

4.16 30x30cm Ground plane (Edge) - Patterns at 1470 MHz

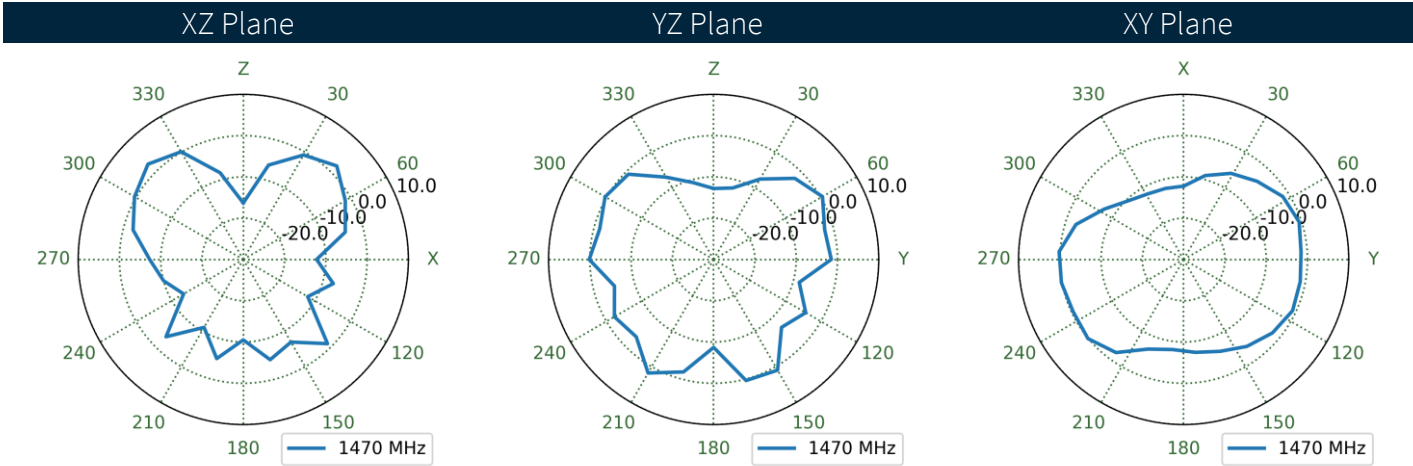
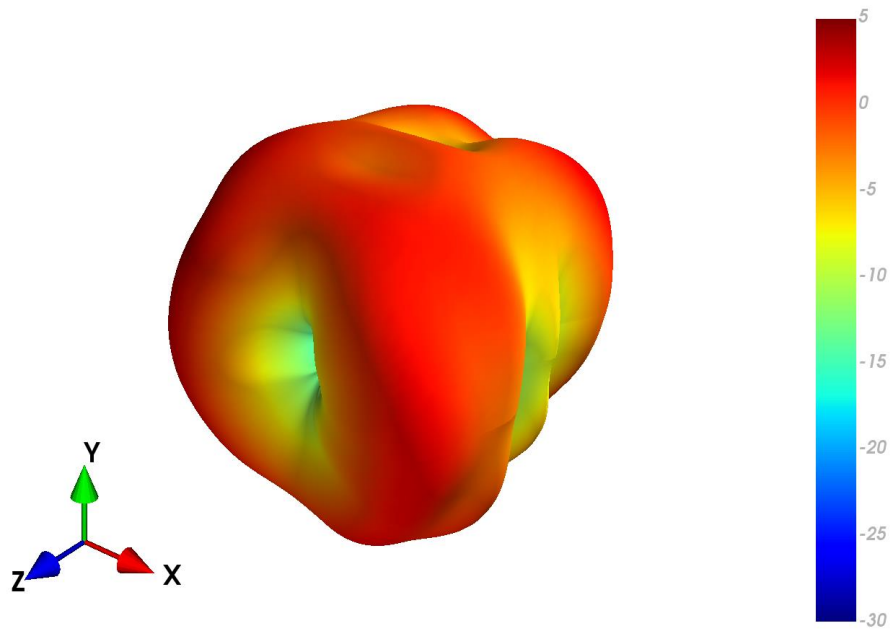

4.17 30x30cm Ground plane (Centre) - Patterns at 1805 MHz

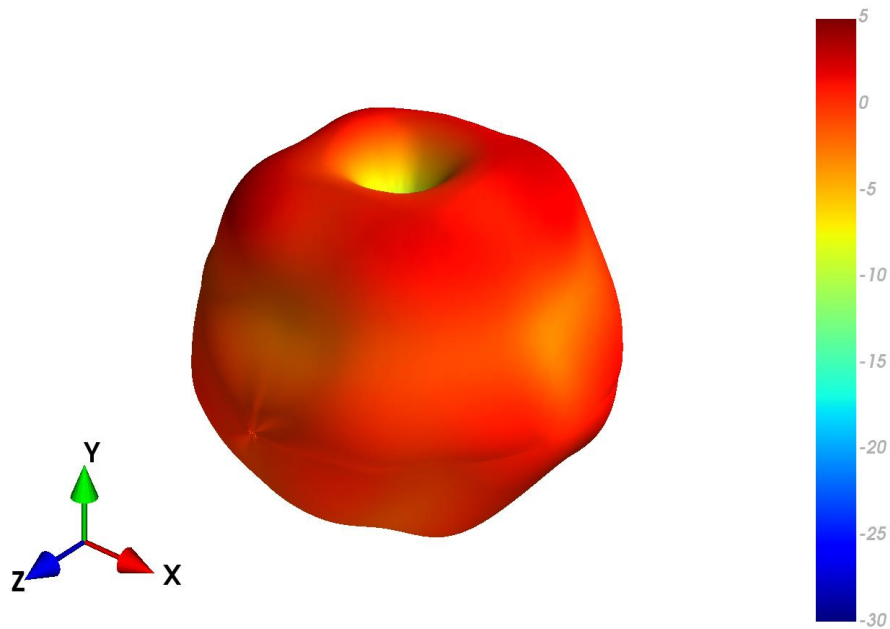

XZ Plane YZ Plane XY Plane

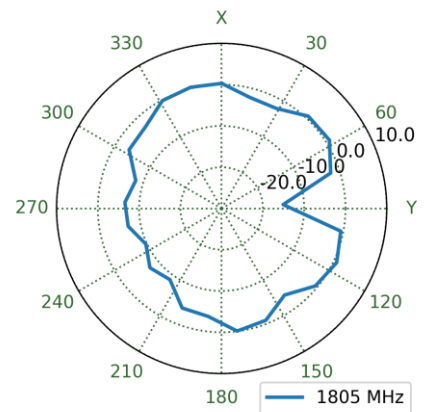
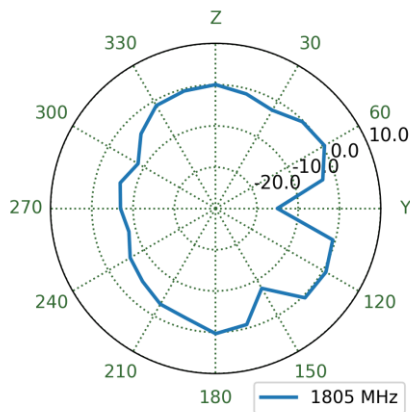
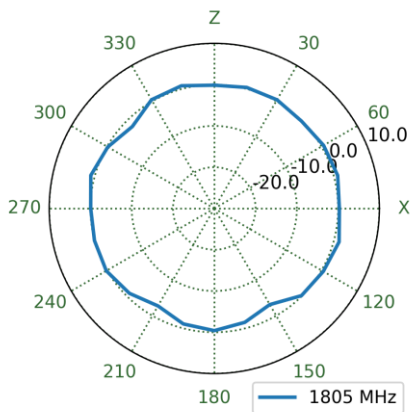

4.18 Free space - Patterns at 1805 MHz

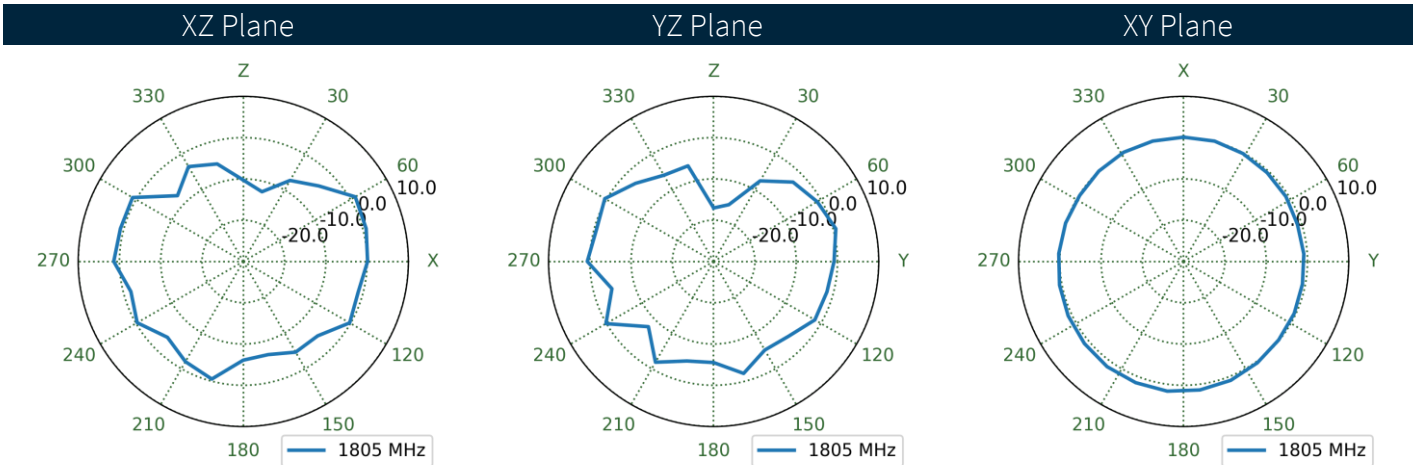
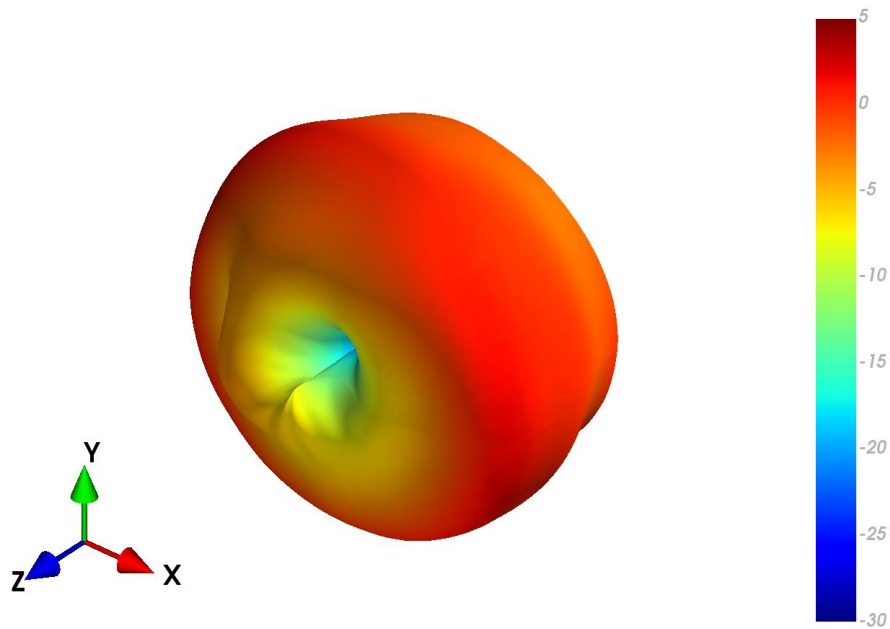

4.19 30x30cm Ground plane (Edge) - Patterns at 1805 MHz

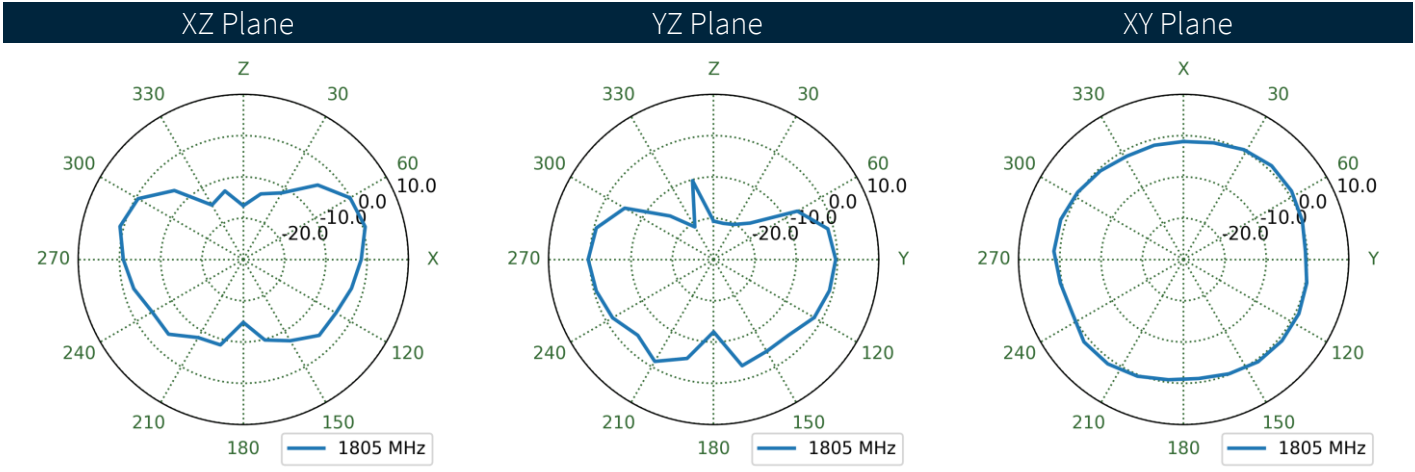
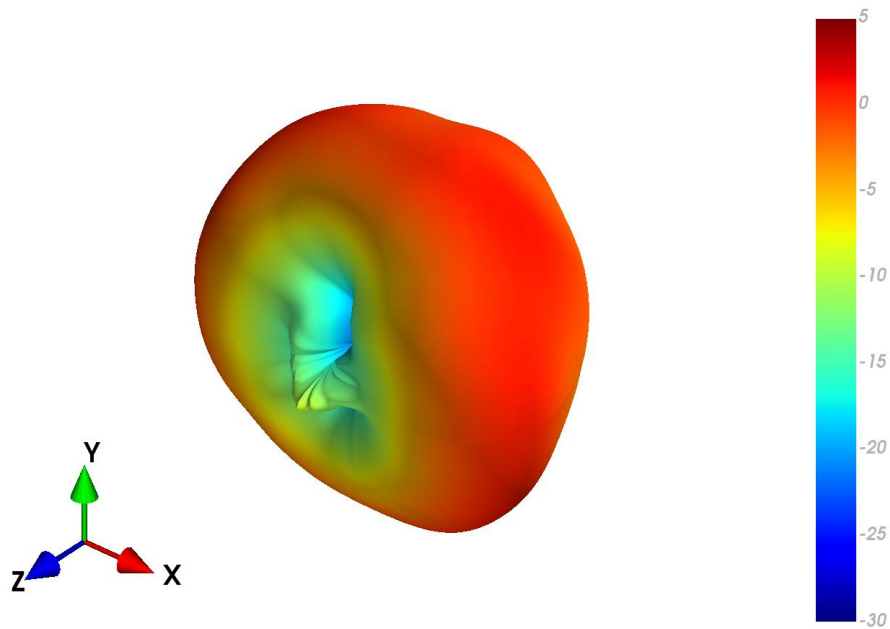

4.20 30x30cm Ground plane (Centre) - Patterns at 1920 MHz

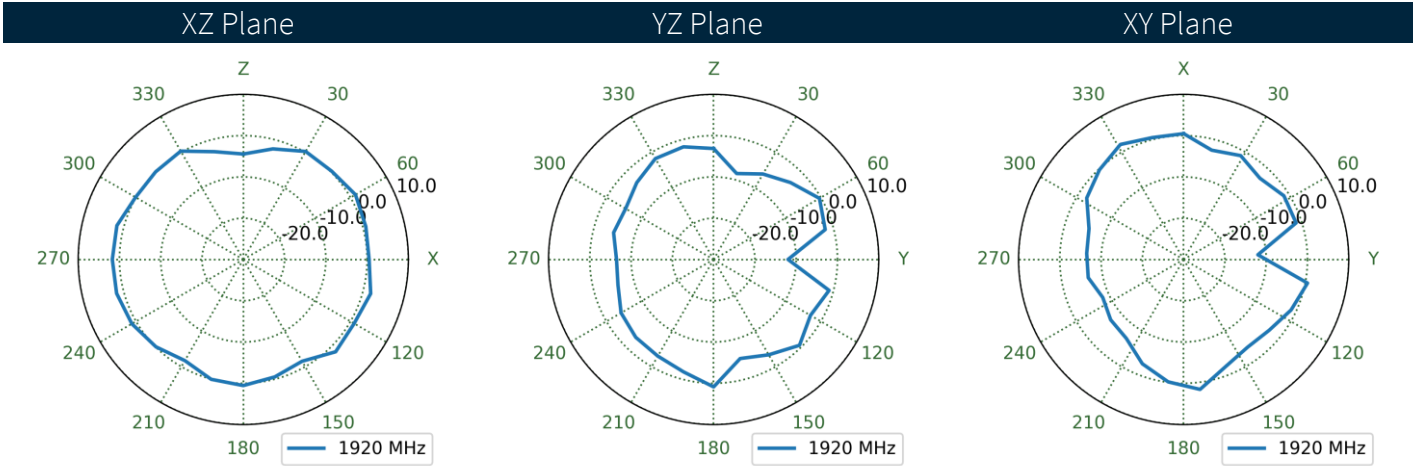
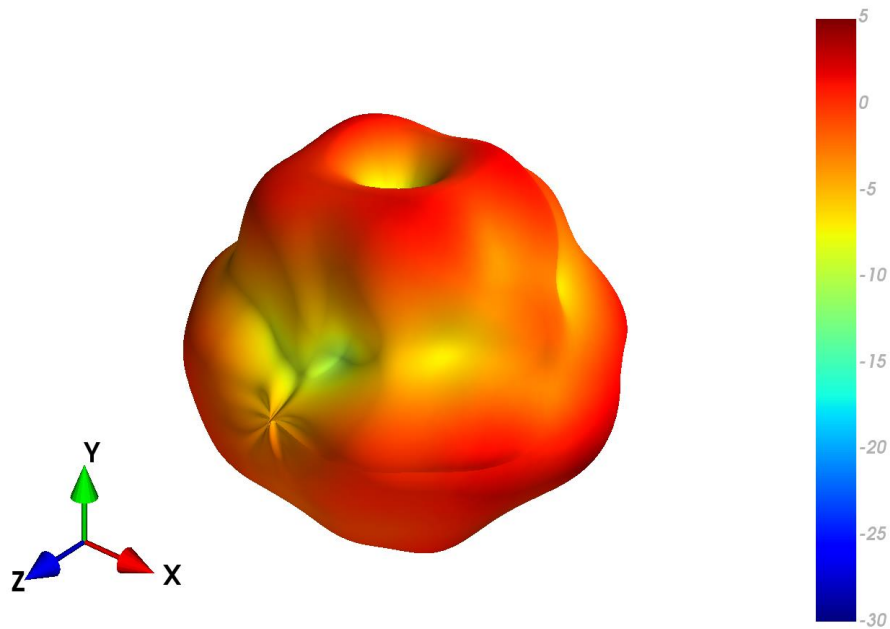

4.21 Free space - Patterns at 1920 MHz

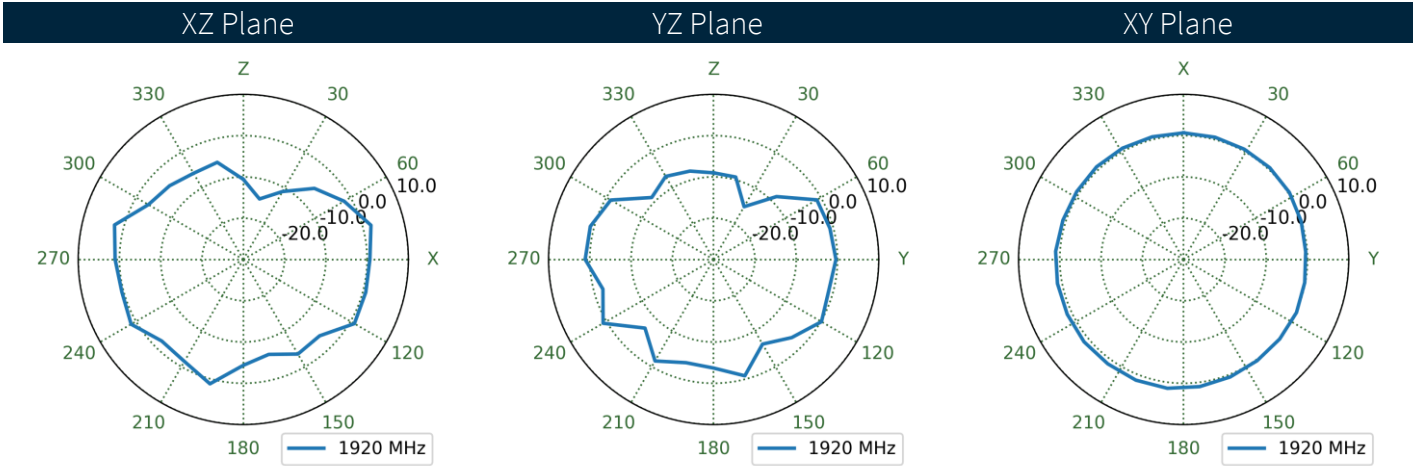
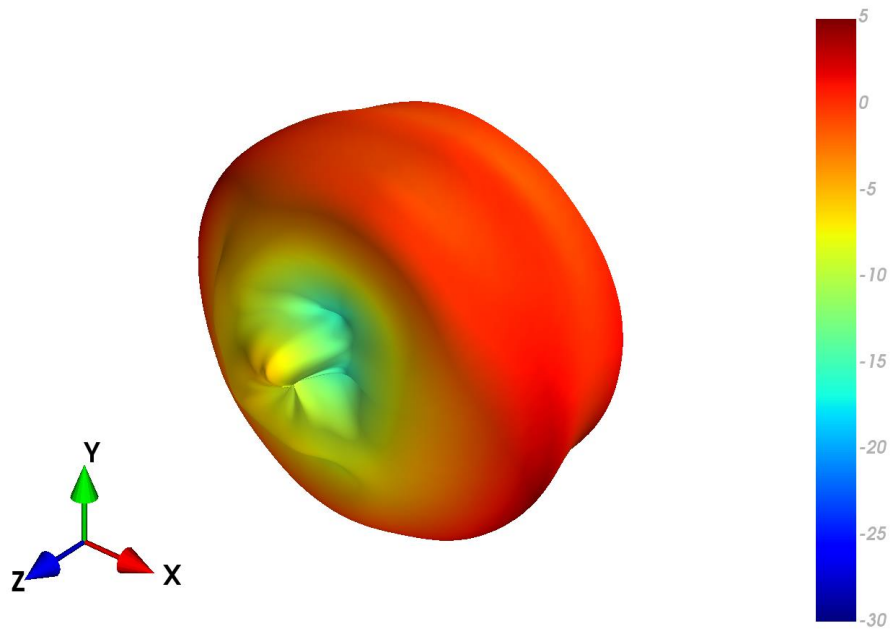

4.22 30x30cm Ground plane (Edge) - Patterns at 1920 MHz

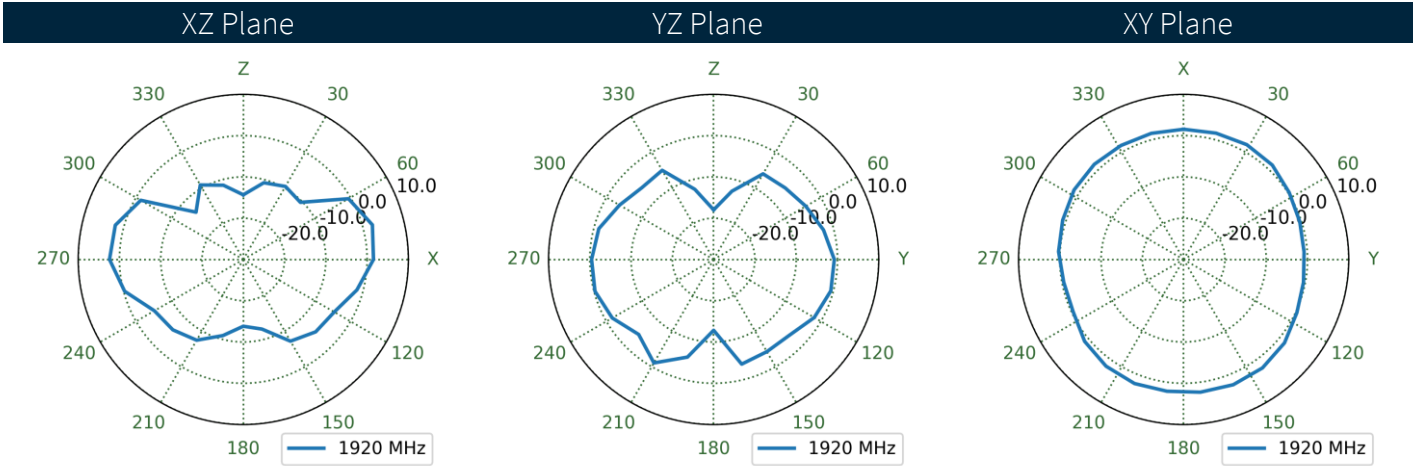
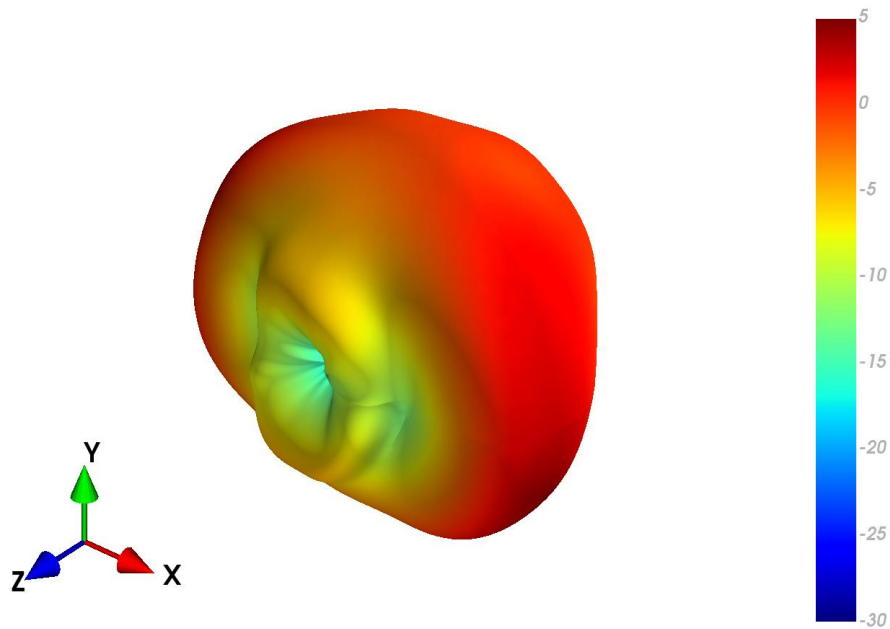

4.23 30x30cm Ground plane (Centre) - Patterns at 2595 MHz

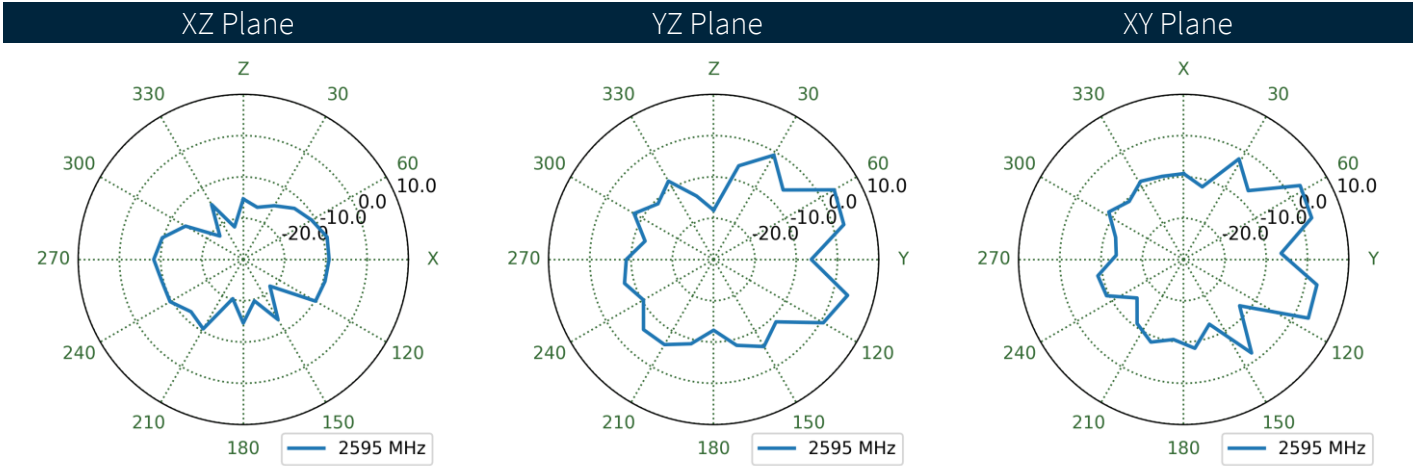
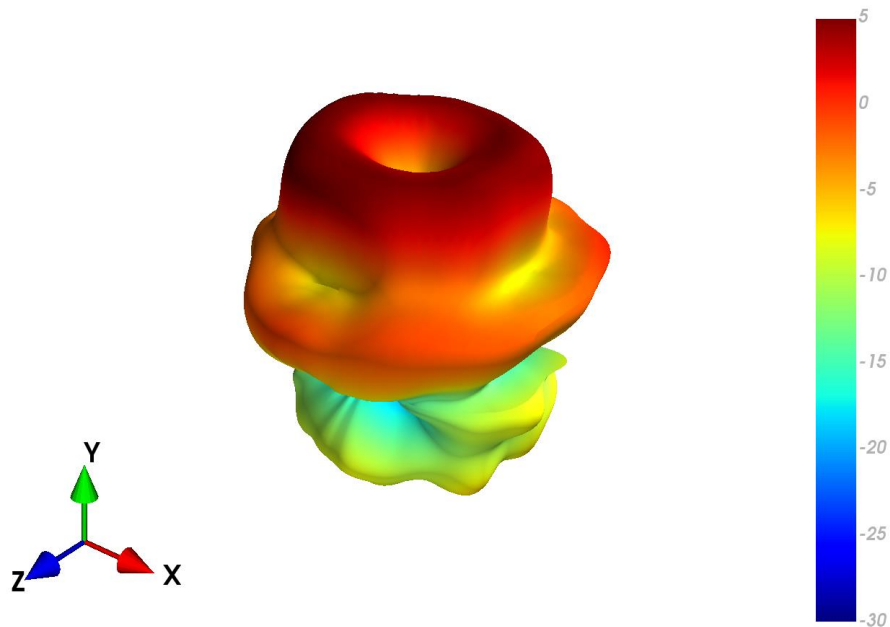

4.24 Free space - Patterns at 2595 MHz

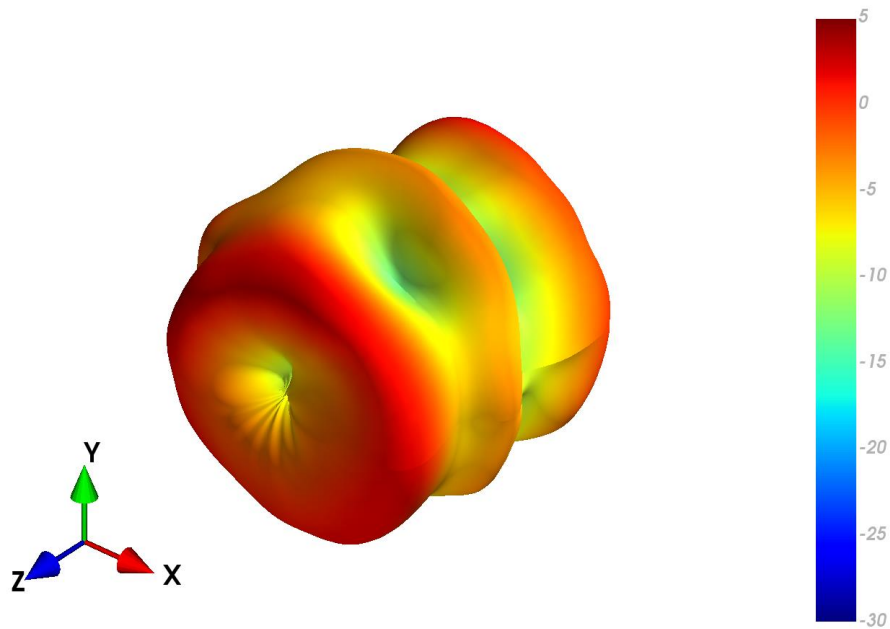

XZ Plane YZ Plane XY Plane

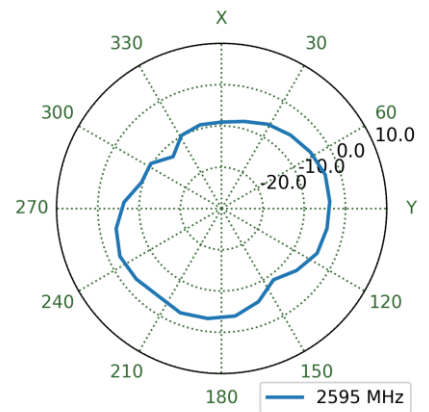
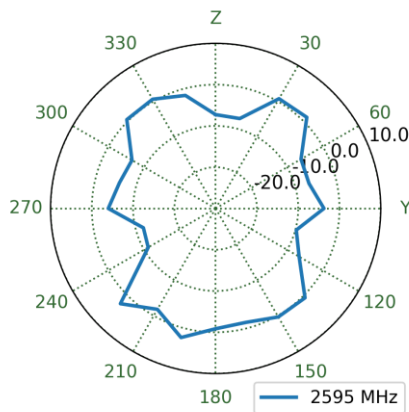
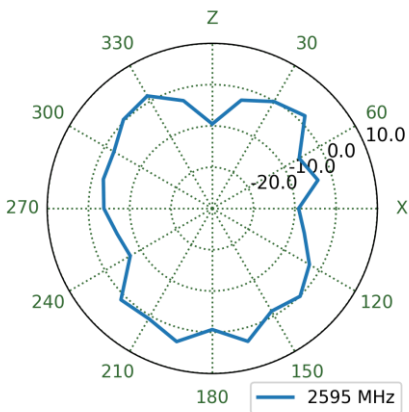

4.25 30x30cm Ground plane (Edge) - Patterns at 2595 MHz

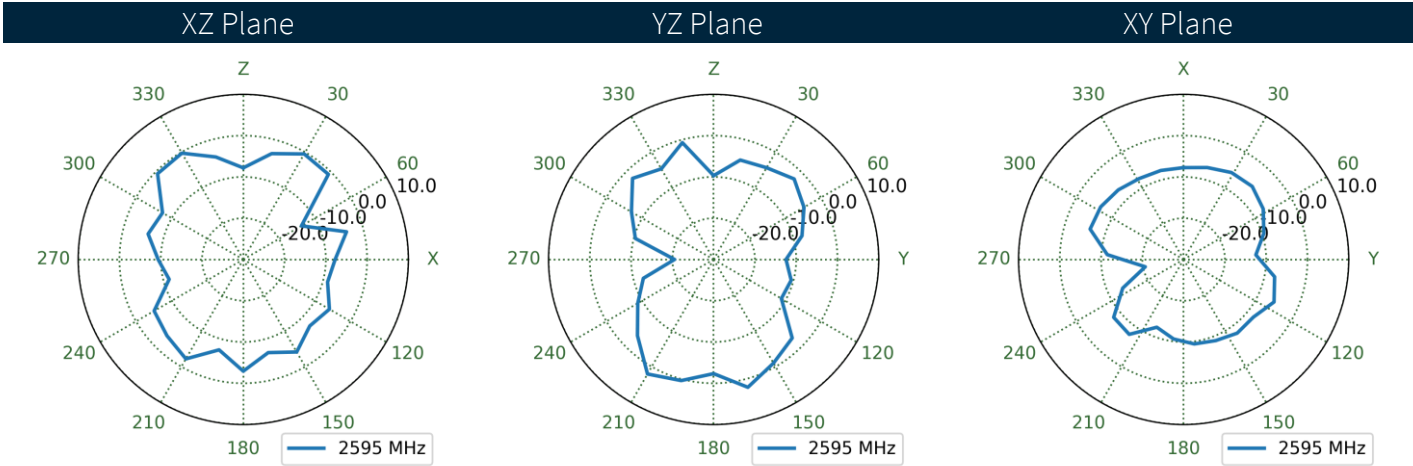
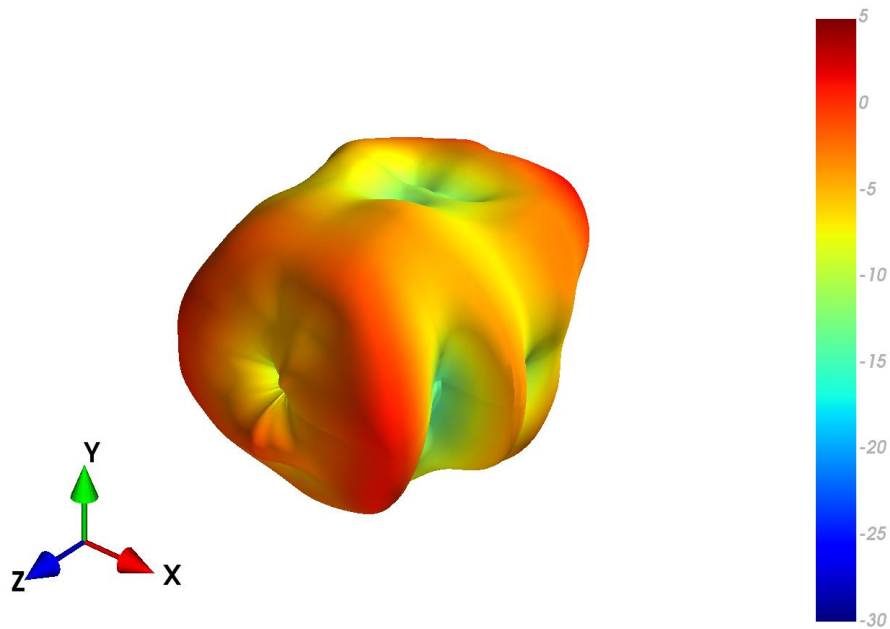

4.26 30x30cm Ground plane (Centre) - Patterns at 3500 MHz

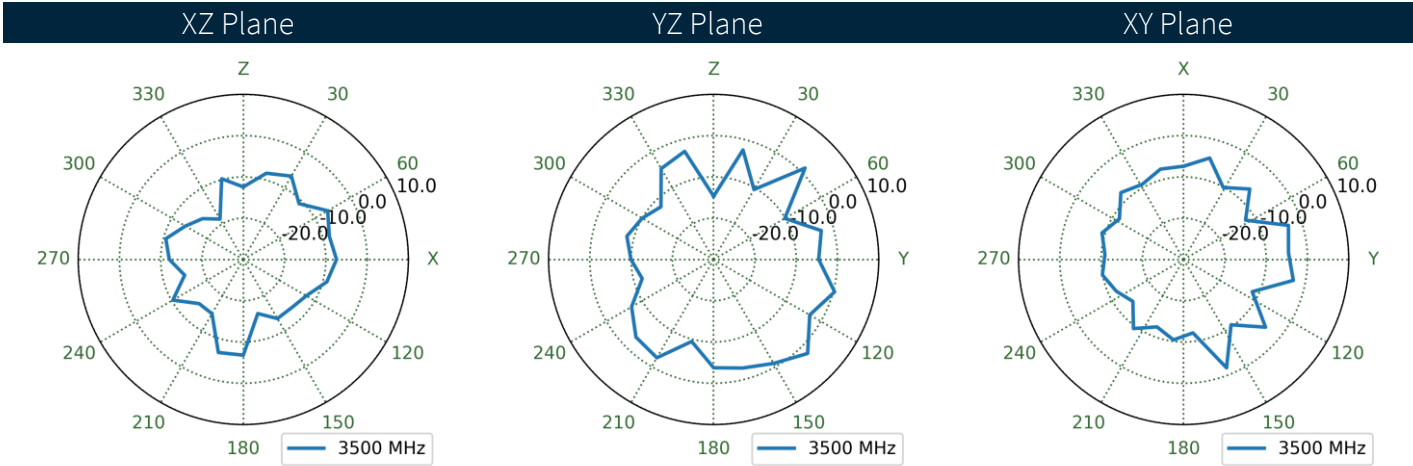
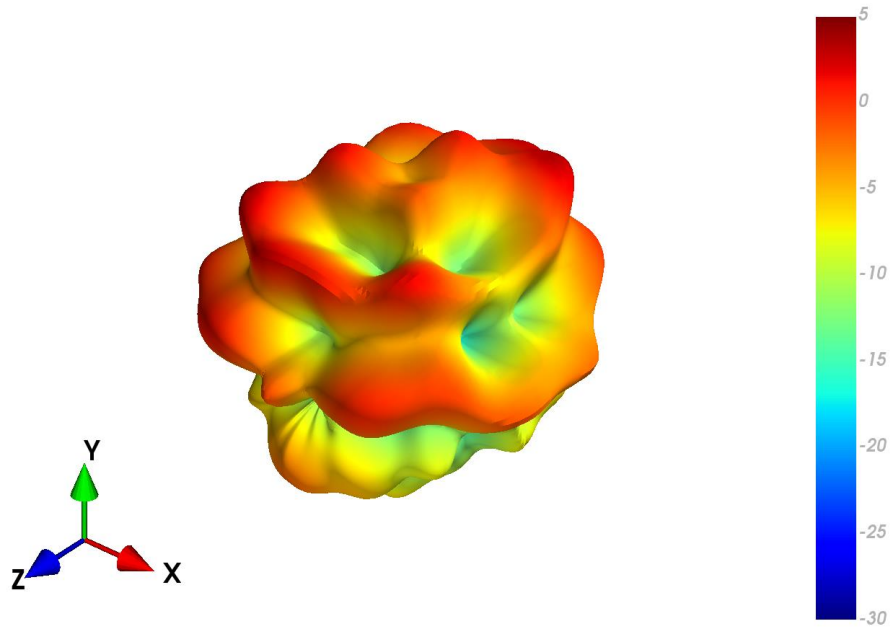

4.27 Free space - Patterns at 3500 MHz

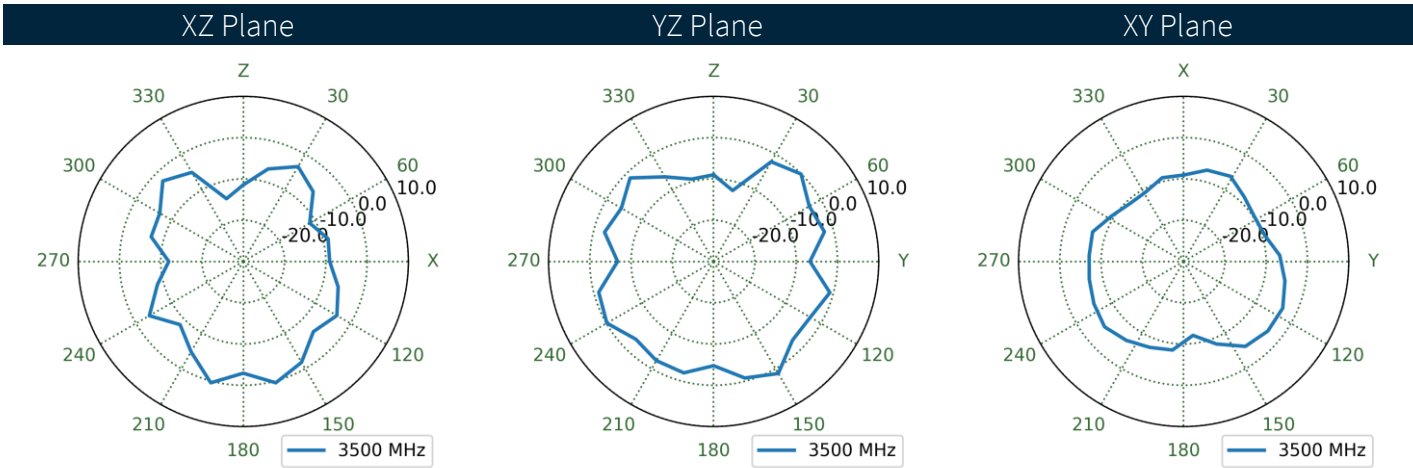
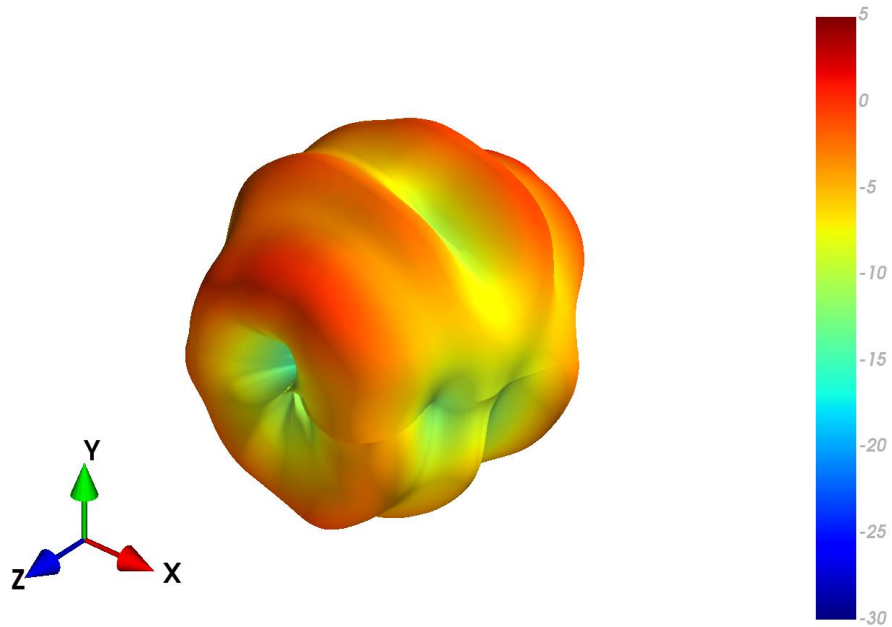

4.28 30x30cm Ground plane (Edge) - Patterns at 3500 MHz

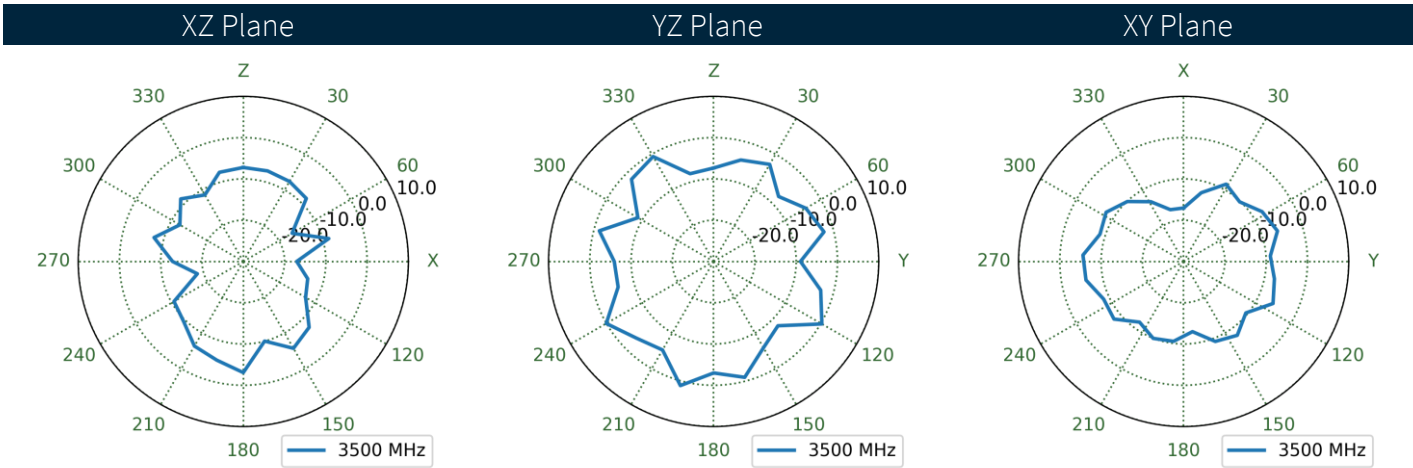
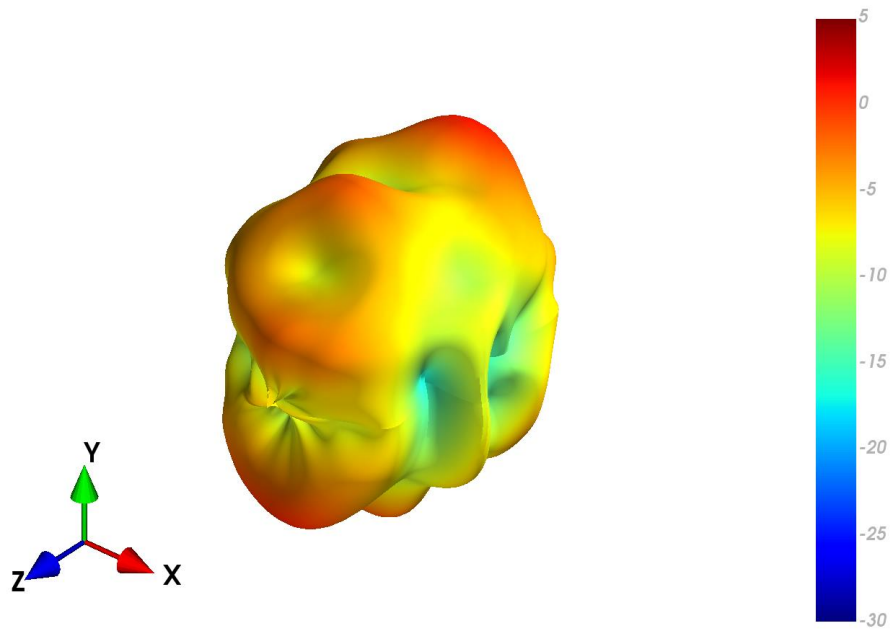

4.29 30x30cm Ground plane (Centre) - Patterns at 5150 MHz

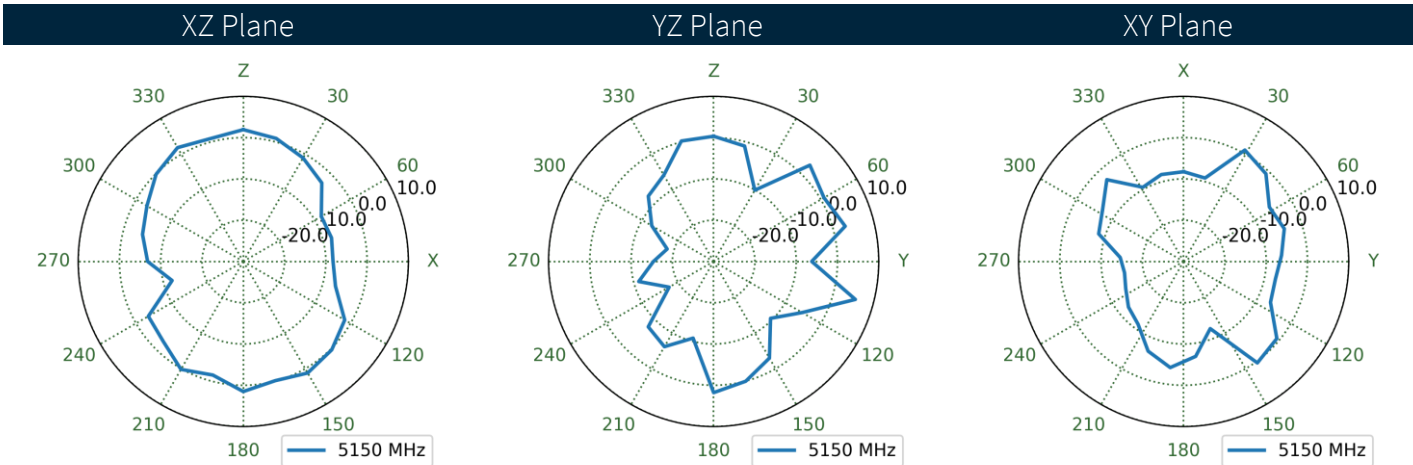
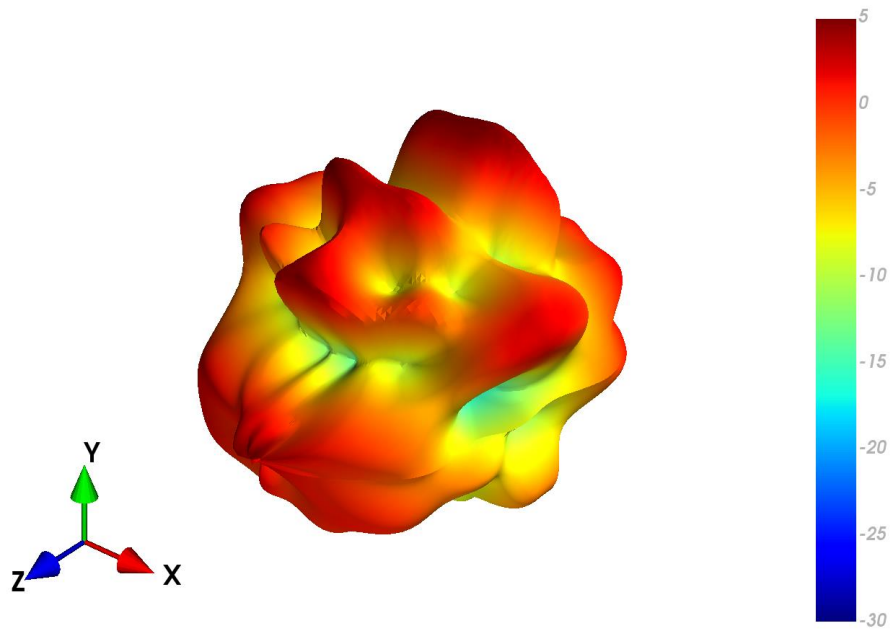

4.30 Free space - Patterns at 5150 MHz

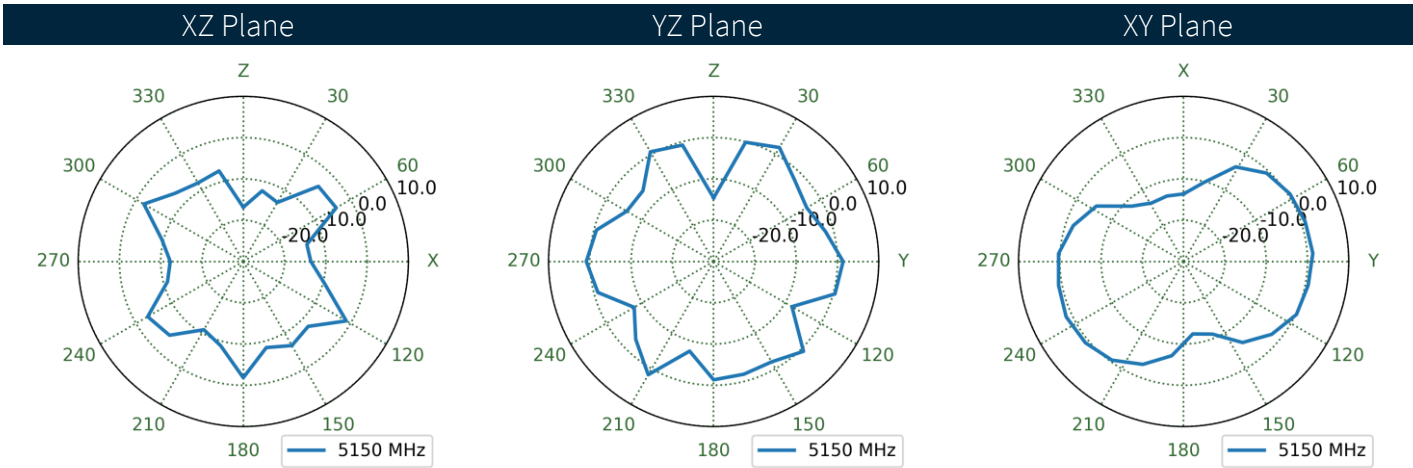
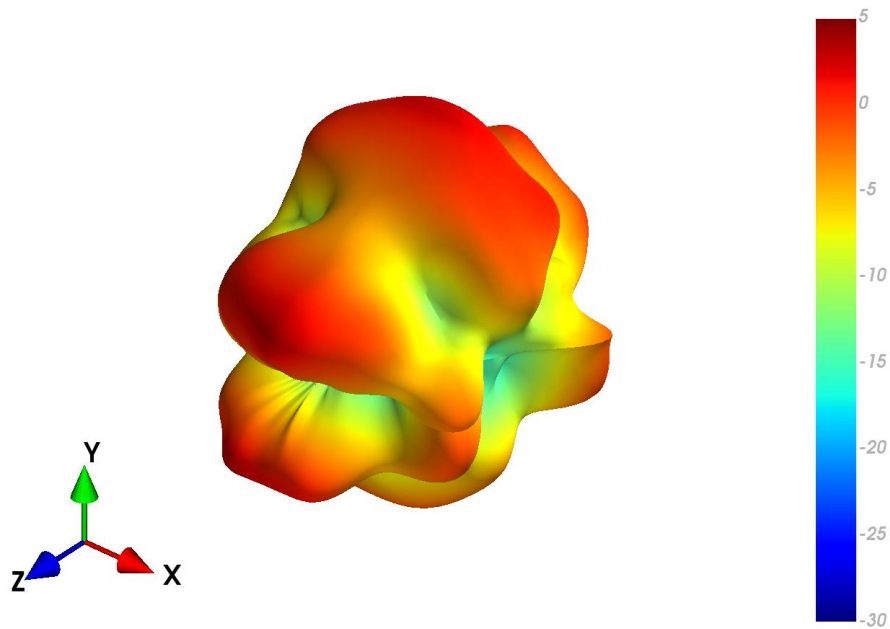

4.31 30x30cm Ground plane (Edge) - Patterns at 5150 MHz

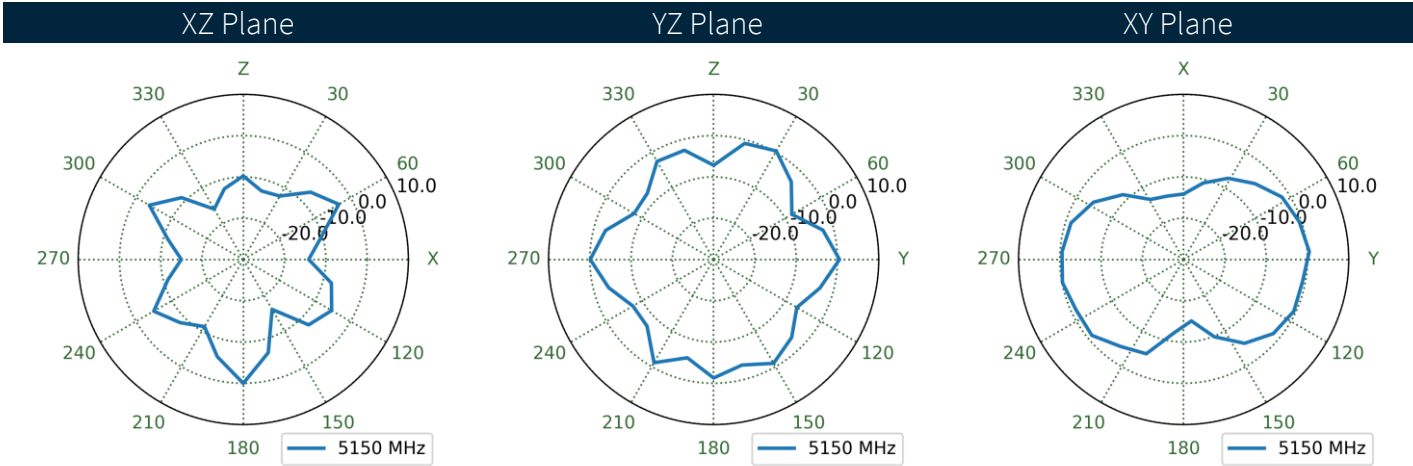
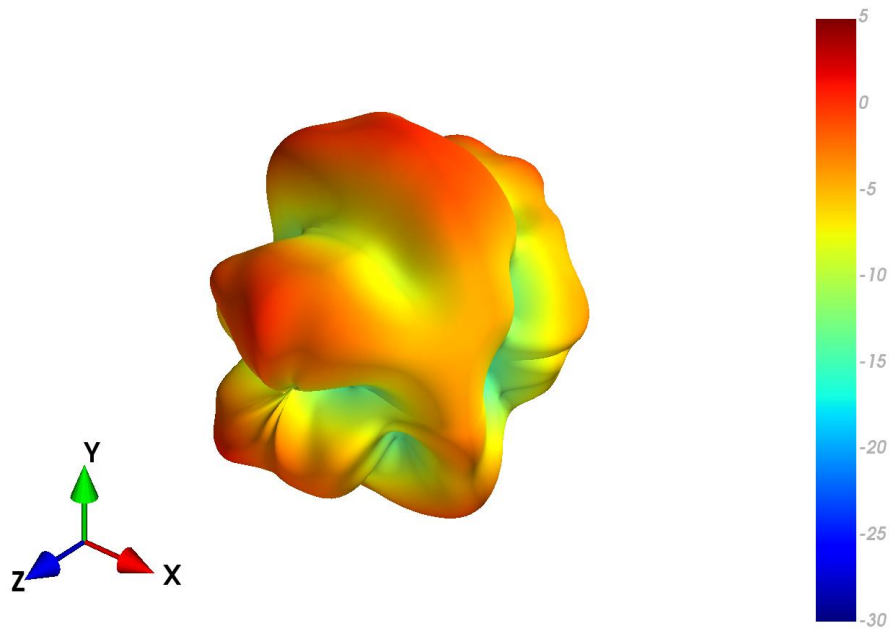

4.32 30x30cm Ground plane (Centre) - Patterns at 5550 MHz

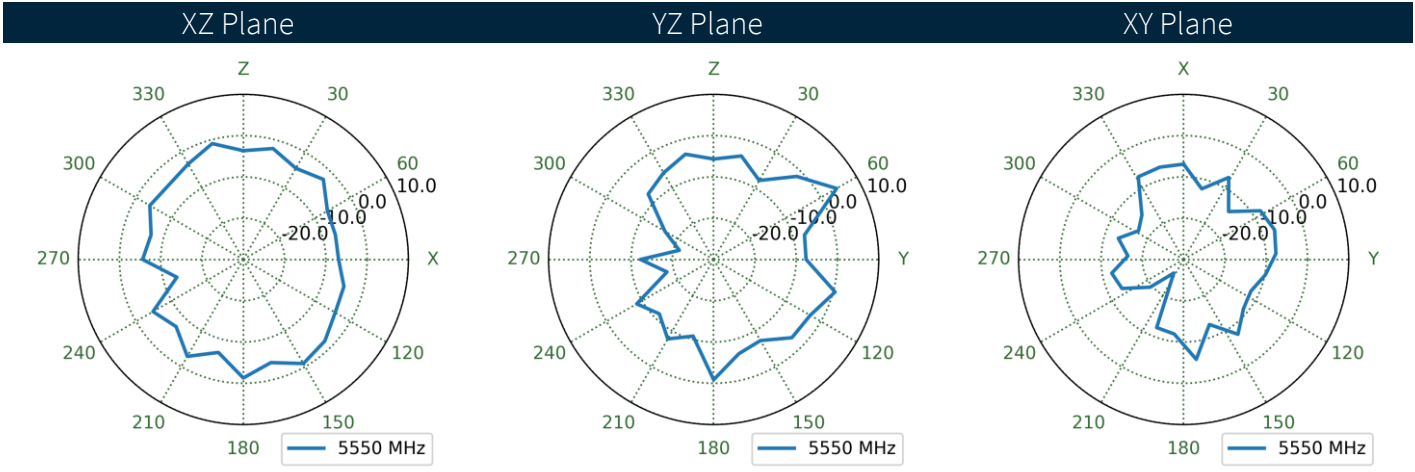
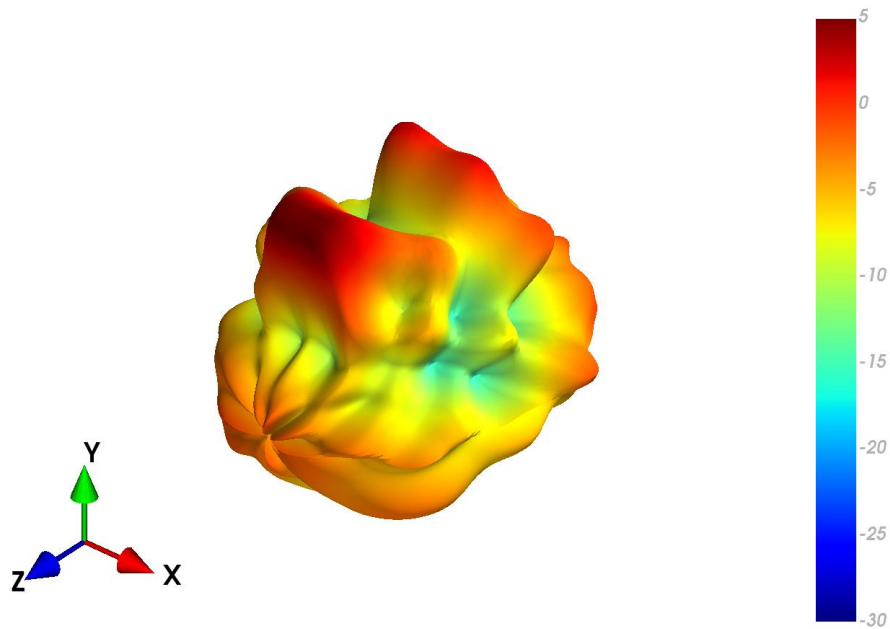

4.33 Free space - Patterns at 5550 MHz

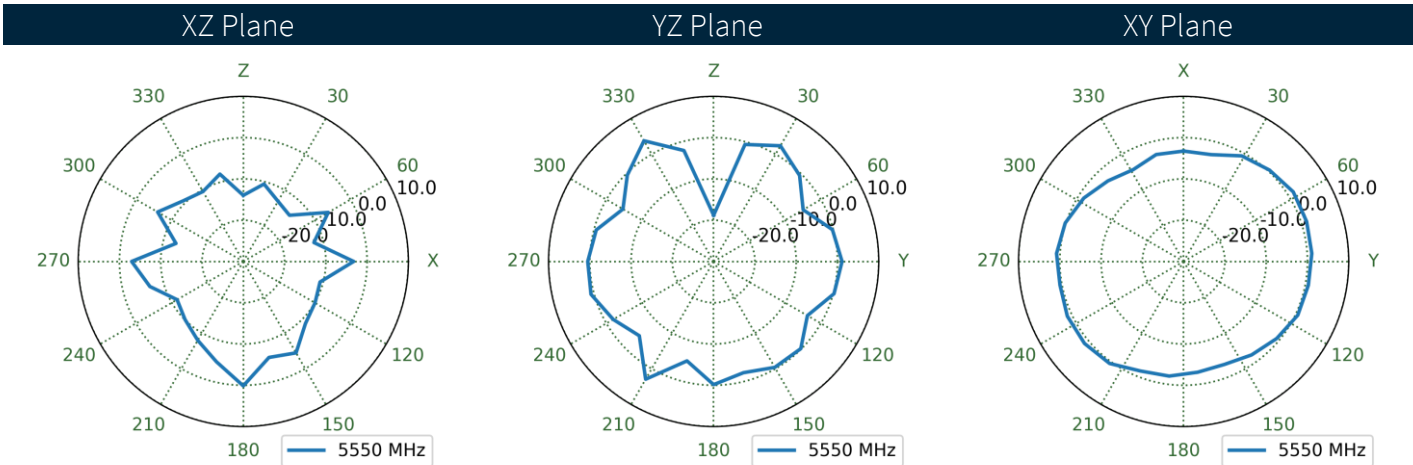
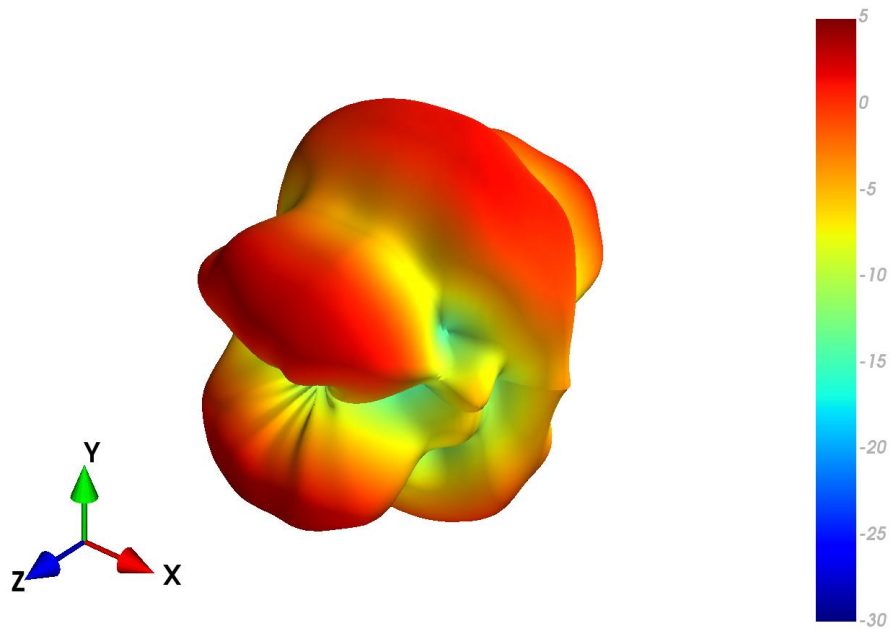

4.34 30x30cm Ground plane (Edge) - Patterns at 5550 MHz

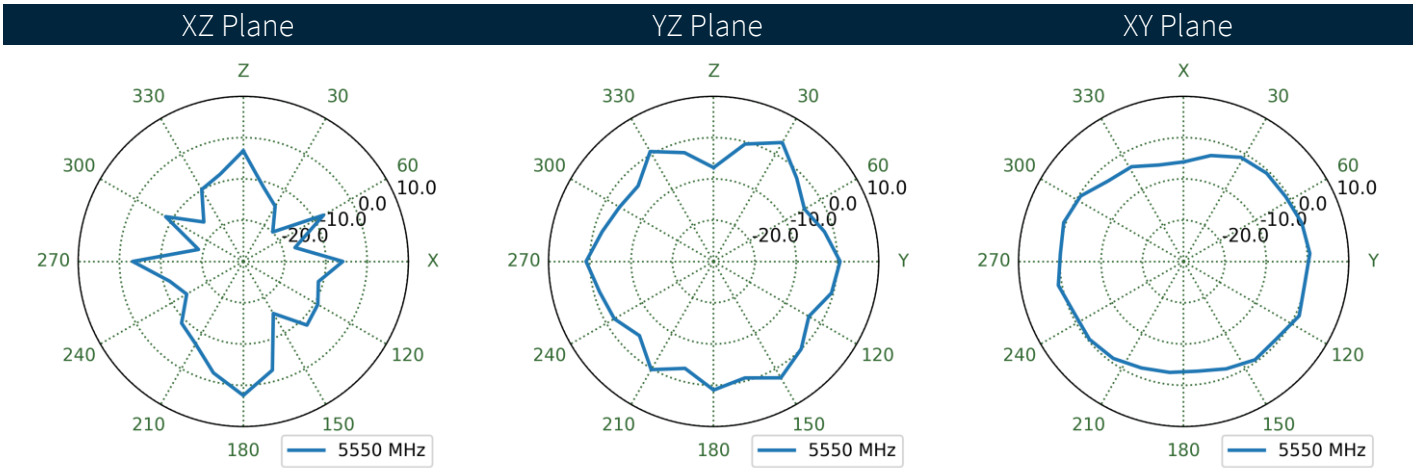
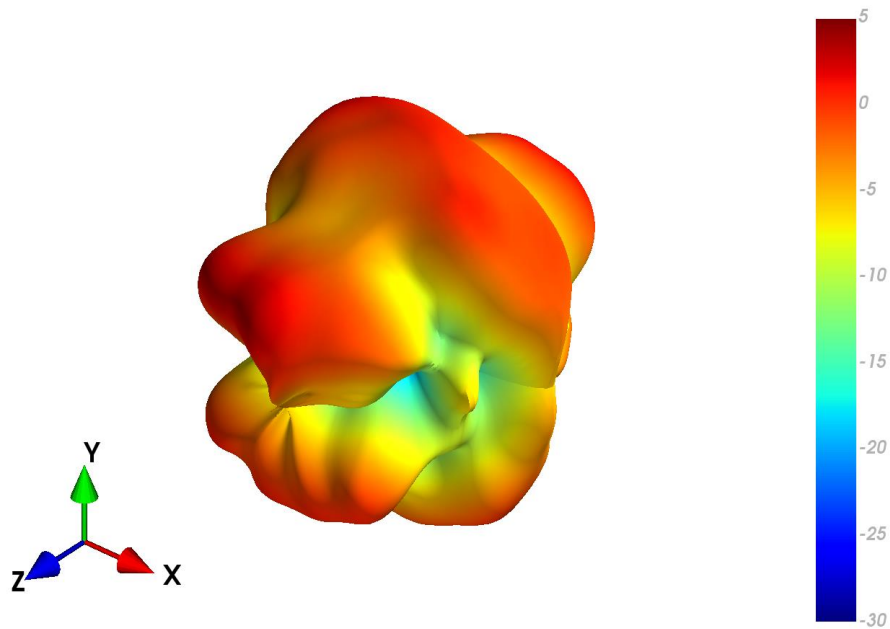

5. Mechanical Drawing

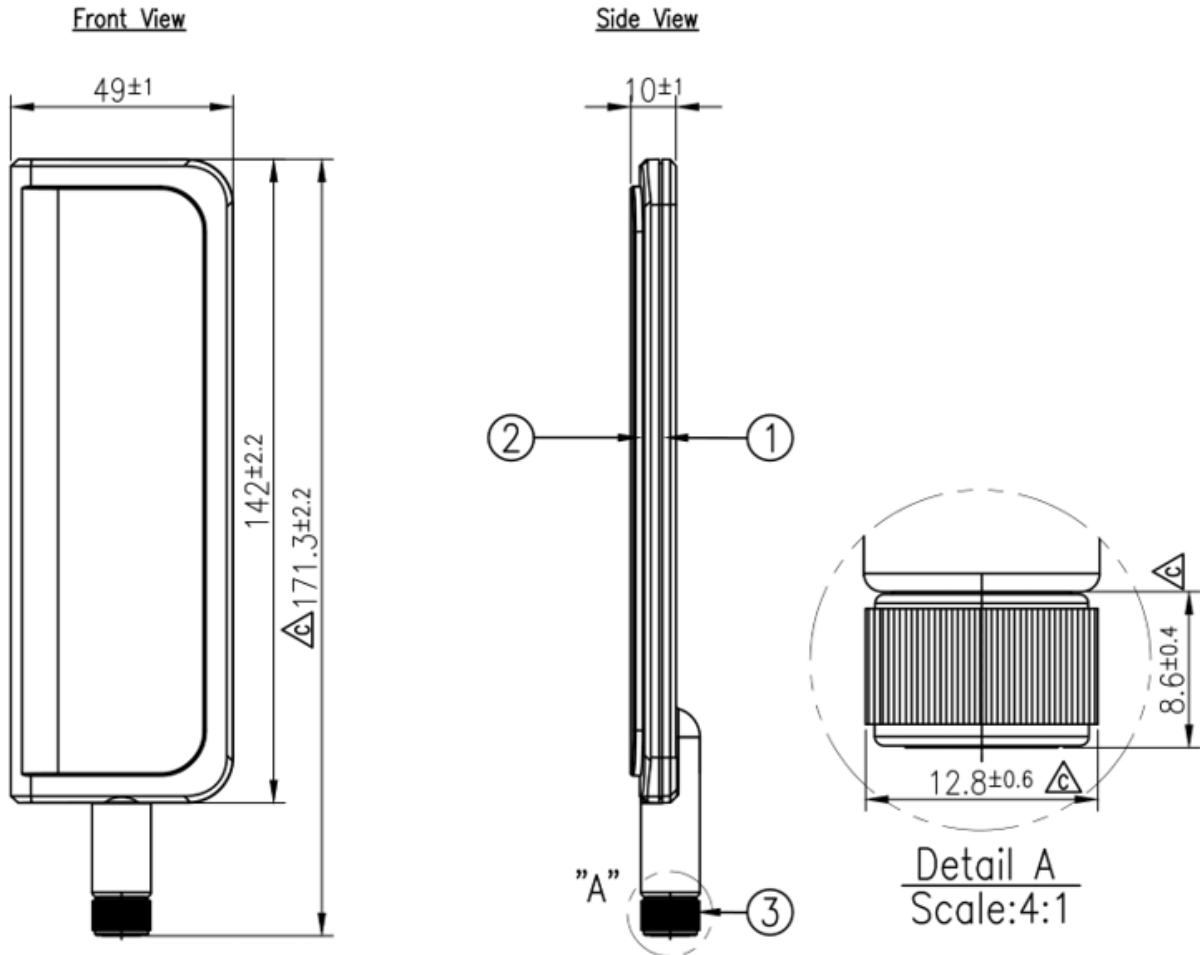

	Name	P/N	Material	Finish	QTY
1	Housing_Bottom_ST_B	000112E050020A	ABS+PC	Black	1
2	Housing_Top_B	000112E000020A	ABS+PC	Black	1
3	SMA(M)ST	210212G010002A	Brass	Black	1

6. Packaging

1pc TG.30.8111 per small PE bag
 Small PE bag dimension – 210*78mm
 Weight – 127g

50pcs TG30.8111 per large PE bag
 Large PE bag dimensions – 450*275mm
 Weight – 6.35kg

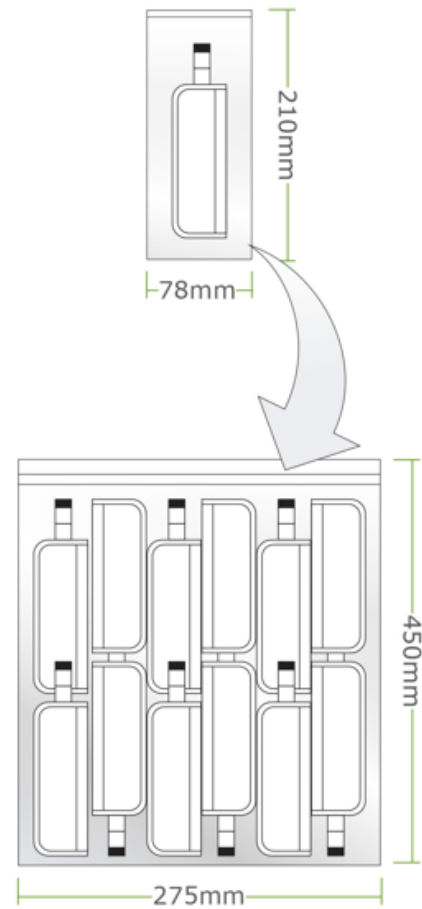

Changelog for the datasheet

SPE-12-8-118 - TG.30.8111

Revision: I (Current Version)

Date:	2023-01-18
Changes:	Adding band 40 to spec table (full datasheet update).
Changes Made by:	Gary West

Previous Revisions

Revision: H

Date:	2022-05-17
Changes:	Updated specifications
Changes Made by:	Cesar Sousa

Revision: C

Date:	2017-01-13
Changes:	
Changes Made by:	Technical Writer

Revision: G

Date:	2022-05-17
Changes:	Full datasheet template update and show data 600-6000.
Changes Made by:	Gary West

Revision: B

Date:	2012-10-02
Changes:	
Changes Made by:	Technical Writer

Revision: F

Date:	2018-11-30
Changes:	Removed IP rating
Changes Made by:	Jack Conroy

Revision: A (Original First Release)

Date:	2012-09-19
Notes:	
Author:	Technical Writer

Revision: E

Date:	Unknown
Changes:	
Changes Made by:	Technical Writer

Revision: D

Date:	2017-03-30
Changes:	Updated Spec with LTE table
Changes Made by:	Andy Mahoney