



TAOGLAS®



Datasheet

Apex Right Angle TG.30

Part No:
TG.30.8112

Features:

600-6000MHz

Covers 5G/4G Bands

Typical 50%+ Efficiency and 3dBi+ Peak Gain

Dipole Terminal Antenna

90° termination with SMA(M) Connector

RoHS and REACH Compliant

1.	Introduction	2
2.	Specification	3
3.	Antenna Characteristics	6
4.	Radiation Patterns	9
5.	Mechanical Drawing	43
6.	Packaging	44
<hr/>		
	Changelog	45

Taoglas makes no warranties based on the accuracy or completeness of the contents of this document and reserves the right to make changes to specifications and product descriptions at any time without notice. Taoglas reserves all rights to this document and the information contained herein. Reproduction, use or disclosure to third parties without express permission is strictly prohibited.



1. Introduction



The Apex TG.30 is a Wideband Dipole 5G/4G Antenna – is primarily designed for use with 5G/4G modules, routers and devices that require the highest possible efficiency and peak gain to deliver best in class throughput on all major cellular bands worldwide between 600MHz and 6GHz.

This fixed 90 degree, connector mount, dipole antenna is primarily designed for use with 5G/4G modules and devices that require the highest possible efficiency and peak gain in order to deliver best-in-class throughput.

Typical Applications include:

- Routers and Gateways
- Access Points
- Remote Monitoring

With very high efficiency on every cellular band globally it is an ideal solution for any device requiring high, reliable performance. It is also guaranteed to meet any type approval or carrier certification requirements from a RF standpoint.

This patented antenna is available in White and Black versions. It is also available with swivel 90 degrees and straight connectors.

For further information please contact your regional Taoglas customer support team.

2. Specification

Electrical									
Band	Frequency (MHz)	Measurement	Efficiency (%)	Average Gain (dB)	Peak Gain (dBi)	Impedance	Polarization	Radiation Pattern	Max. input power
5G NR/4G Band 5,8,12,13,14,17,18,20,26,27,28,29,71	617-960	30X30cm Ground plane (Centre)	18.8	-7.26	1.40	50 Ω	Linear	Omni	2W
		In Free Space	58.5	-2.33	2.58				
		30X30cm Ground plane (Edge)	54.5	-2.64	2.77				
5G NR/4G Band 21,32,74,75,76	1427-1518	30X30cm Ground plane (Centre)	66.3	-1.79	7.25				
		In Free Space	50.4	-2.98	5.64				
		30X30cm Ground plane (Edge)	67.0	-1.74	2.49				
4G/3G Band 1,2,3,4,9,23,25,35,39,66	1710-2200	30X30cm Ground plane (Centre)	62.8	-2.02	7.79				
		In Free Space	82.7	-0.82	4.29				
		30X30cm Ground plane (Edge)	68.7	-1.63	2.99				
4G/3G Band 40	2300-2400	30X30cm Ground plane (Centre)	42.3	-3.73	4.59				
		In Free Space	81.7	-0.88	4.41				
		30X30cm Ground plane (Edge)	68.1	-1.67	3.50				
Wi-Fi 2400	2400-2500	30X30cm Ground plane (Centre)	30.9	-5.10	3.10				
		In Free Space	70.9	-1.49	4.18				
		30X30cm Ground plane (Edge)	64.0	-1.94	3.94				
4G/3G Band 7,38,41	2490-2690	30X30cm Ground plane (Centre)	55.4	-2.56	7.06				
		In Free Space	68.1	-1.67	4.41				
		30X30cm Ground plane (Edge)	49.8	-3.03	4.55				
5G NR/4G Band 22,42,43,48,77,78	3300-3800	30X30cm Ground plane (Centre)	42.1	-3.76	6.60				
		In Free Space	42.1	-3.76	3.94				
		30X30cm Ground plane (Edge)	33.7	-4.72	4.06				
LTE5200/ Wi-Fi 5800	5150-5925	30X30cm Ground plane (Centre)	34.5	-4.62	7.09				
		In Free Space	67.1	-1.73	5.69				
		30X30cm Ground plane (Edge)	43.2	-3.65	4.69				

5G/4G Bands					
Band Number	5G NR / FR1 / LTE / LTE-Advanced / WCDMA / HSPA / HSPA+ / TD-SCDMA				
	Uplink	Downlink	30X30cm Ground plane (Centre)	In Free space	30X30cm Ground plane (Edge)
B1	1920 to 1980	2110 to 2170	✓	✓	✓
B2	1850 to 1910	1930 to 1990	✓	✓	✓
B3	1710 to 1785	1805 to 1880	✓	✓	✓
B4	1710 to 1755	2110 to 2155	✓	✓	✓
B5	824 to 849	869 to 894	✓	✓	✓
B7	2500 to 2570	2620 to 2690	✓	✓	✓
B8	880 to 915	925 to 960	✓	✓	✓
B9*	1749.9 to 1784.9	1844.9 to 1879.9	✓	✓	✓
B11	1427.9 to 1447.9	1475.9 to 1495.9	✓	✓	✓
B12	699 to 716	729 to 746	✗	✓	✓
B13	777 to 787	746 to 756	✓	✓	✓
B14	788 to 798	758 to 768	✓	✓	✓
B17	704 to 716	734 to 746	✗	✓	✓
B18	815 to 830	860 to 875	✓	✓	✓
B19	830 to 845	875 to 890	✓	✓	✓
B20	832 to 862	791 to 821	✓	✓	✓
B21	1447.9 to 1462.9	1495.9 to 1510.9	✓	✓	✓
B22*	3410 to 3490	3510 to 3590	✓	✓	✗
B23*	2000 to 2020	2180 to 2200	✓	✓	✓
B24	1626.5 to 1660.5	1525 to 1559	✓	✓	✓
B25	1850 to 1915	1930 to 1995	✓	✓	✓
B26	814 to 849	859 to 894	✓	✓	✓
B27*	807 to 824	852 to 869	✓	✓	✓
B28	703 to 748	758 to 803	✗	✓	✓
B29		717 to 728	✗	✓	✓
B30	2305 to 2315	2350 to 2360	✓	✓	✓
B31	452.5 to 457.5	462.5 to 467.5	✗	✗	✗
B32		1452 to 1496	✓	✓	✓
B34		2010 to 2025	✓	✓	✓
B35		1850 to 1910	✓	✓	✓
B36		1930 to 1990	✓	✓	✓
B37		1910 to 1930	✓	✓	✓
B38		2570 to 2620	✓	✓	✓
B39		1880 to 1920	✓	✓	✓
B40		2300 to 2400	✓	✓	✓
B41		2496 to 2690	✓	✓	✓
B42		3400 to 3600	✓	✓	✓
B43		3600 to 3800	✓	✓	✓
B45		1447 to 1467	✓	✓	✓
B46		5150 to 5925	✓	✓	✓
B47		5855 to 5925	✓	✓	✓
B48		3550 to 3700	✓	✓	✓
B49		3550 to 3700	✓	✓	✓
B50		1432 to 1517	✓	✓	✓
B51		1427 to 1432	✓	✓	✓
B52		3300 to 3400	✗	✓	✗
B53		2483.5 to 2495	✓	✓	✓
B65	1920 to 2010	2110 to 2200	✓	✓	✓
B66	1710 to 1780	2110 to 2200	✓	✓	✓
B68	698 to 728	753 to 783	✗	✓	✓
B69		2570 to 2620	✓	✓	✓
B70	1695 to 1710	1995 to 2020	✓	✓	✓
B71	663 to 698	617 to 652	✗	✓	✗
B72	451 to 456	461 to 466	✗	✗	✗
B73	450 to 455	460 to 465	✗	✗	✗
B74	1427 to 1470	1475 to 1518	✓	✓	✓
B75		1432 to 1517	✓	✓	✓
B76		1427 to 1432	✓	✓	✓
B77		3300 to 4200	✓	✓	✓
B78		3300 to 3800	✓	✓	✓
B79		4400 to 5000	✓	✓	✓
B85	698 to 716	728 to 746	✗	✓	✓
B87	410 to 415	420 to 425	✗	✗	✗
B88	412 to 417	422 to 427	✗	✗	✗

Mechanical

Dimensions	142 x 49mm
Casing	UV Resistant PC/ABS
Flammability Rating	UL-94
Connector	SMA Male

Environmental

Temperature Range	-40°C to 85°C
Humidity	Non-condensing 65°C 95% RH

3. Antenna Characteristics

3.1 Return Loss

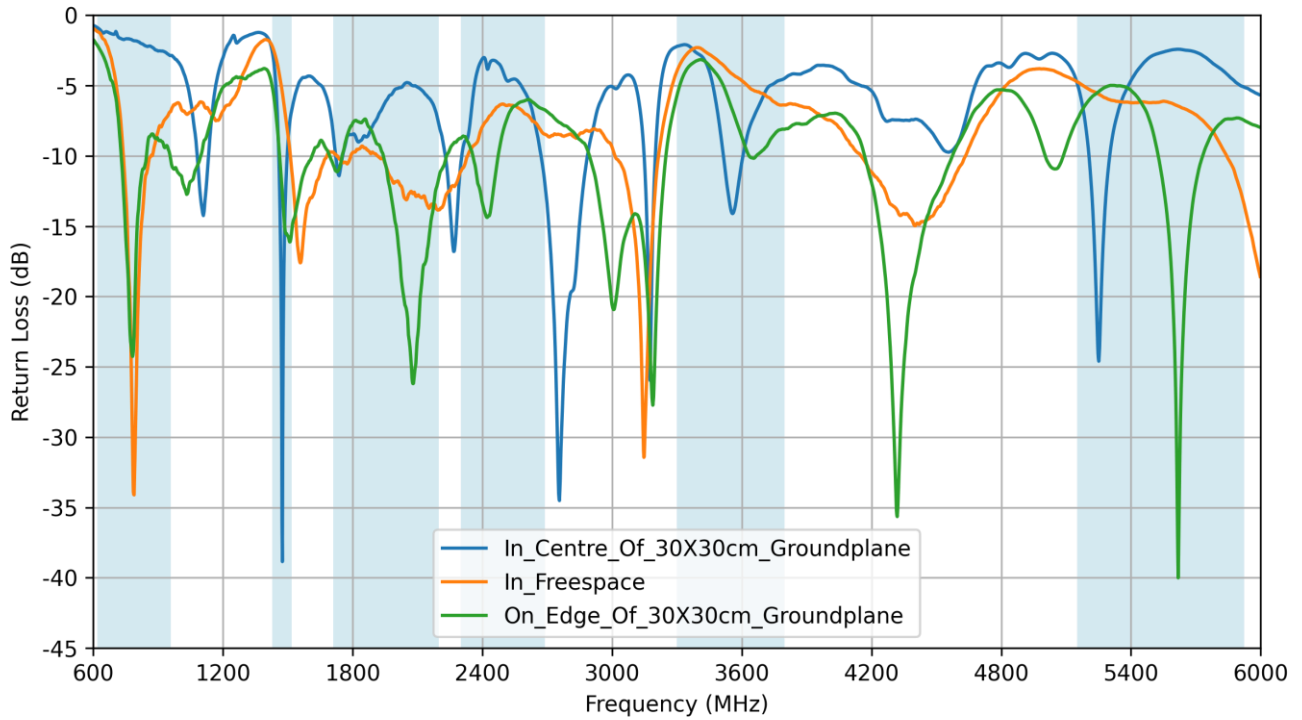

3.2 VSWR

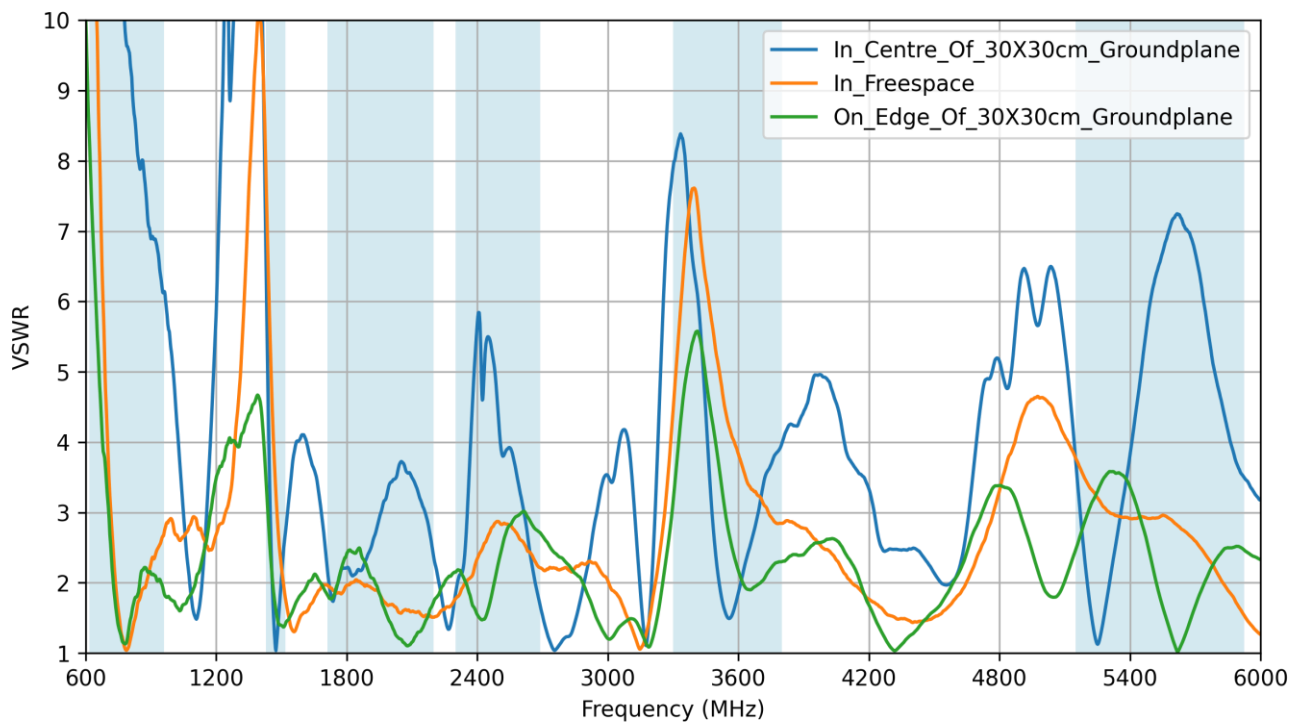

3.3 Efficiency

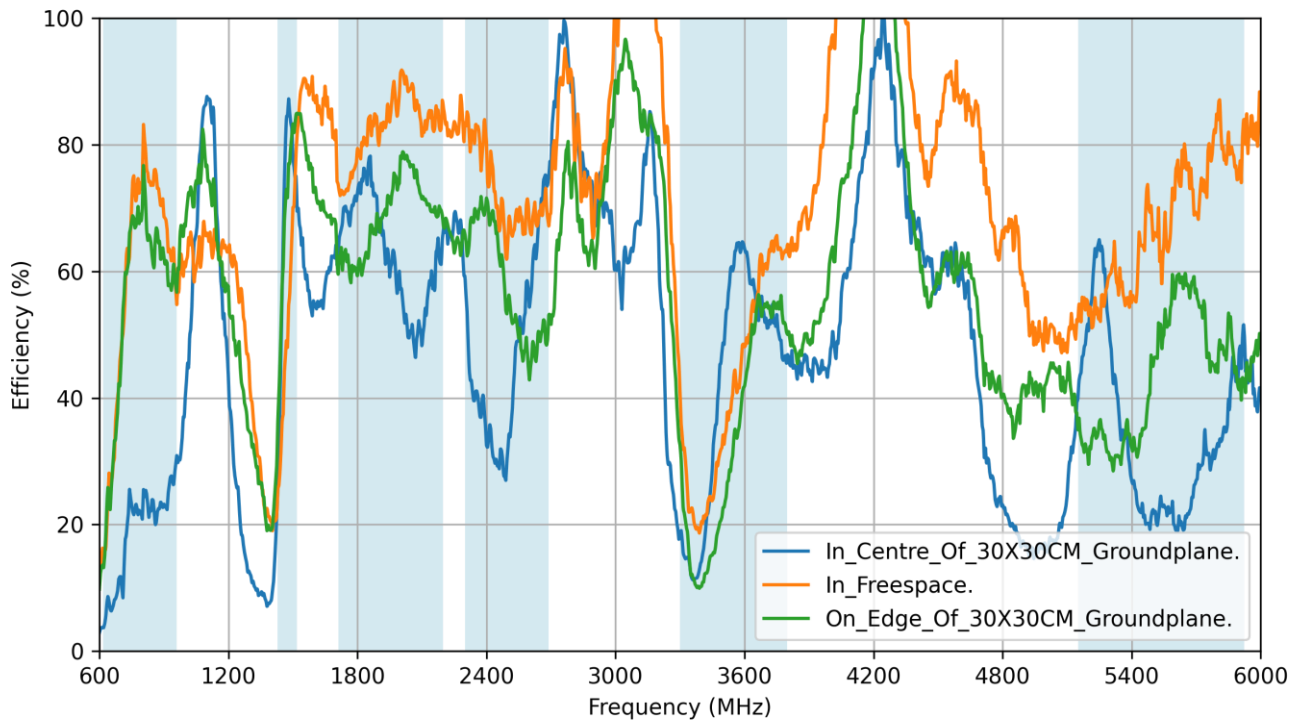

3.4 Average Gain

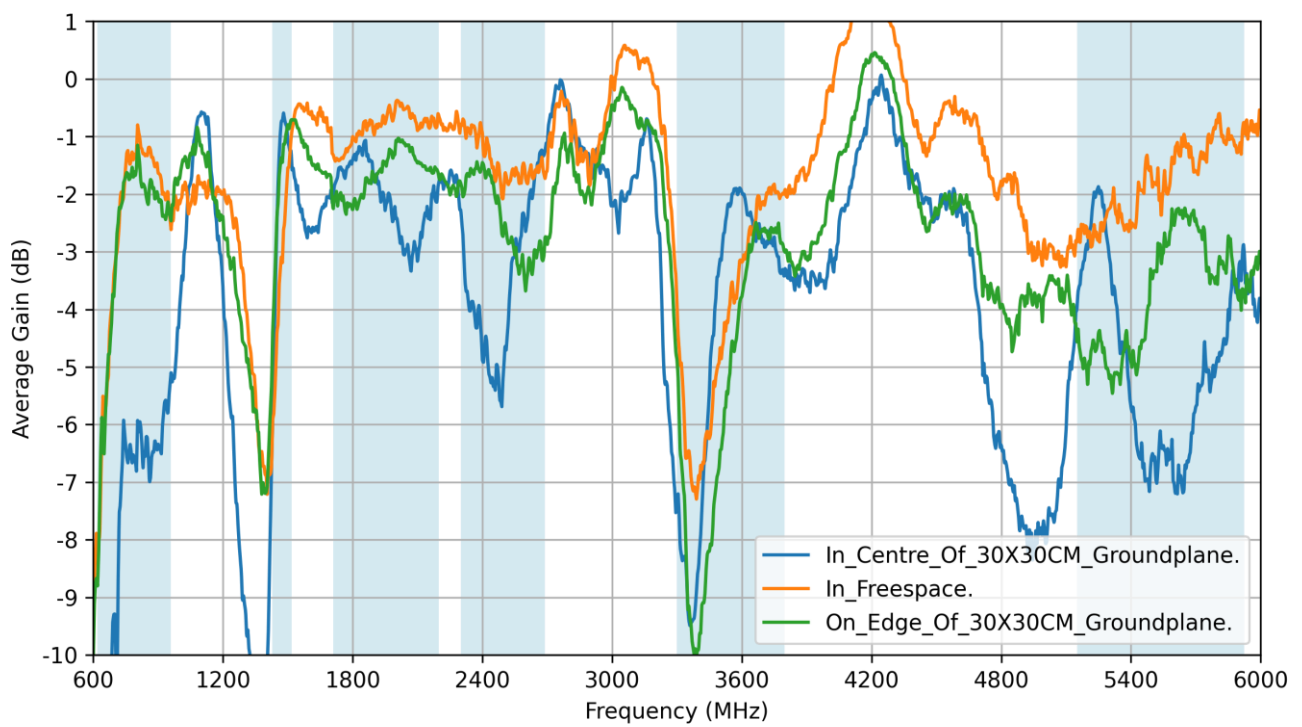

3.5 Peak Gain

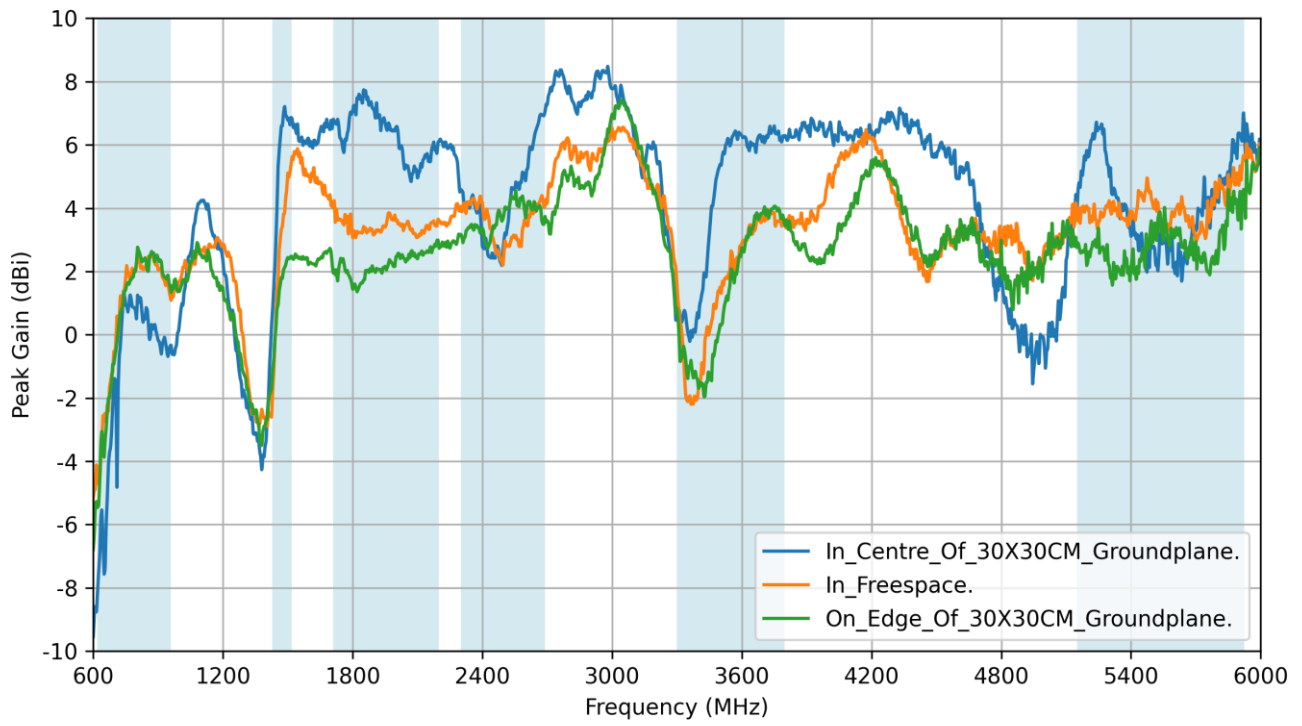

4. Radiation Patterns

4.1 Test Setup

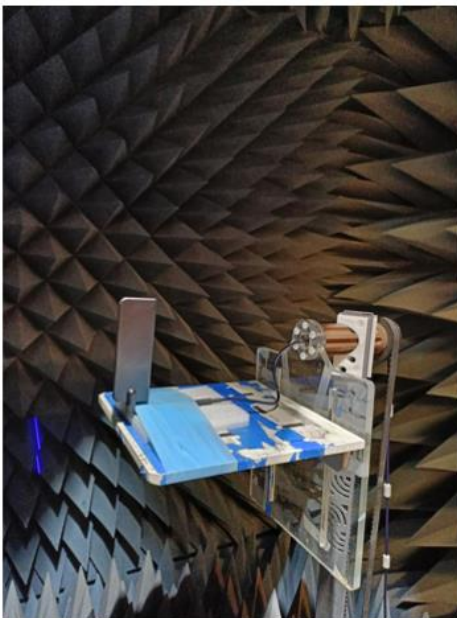
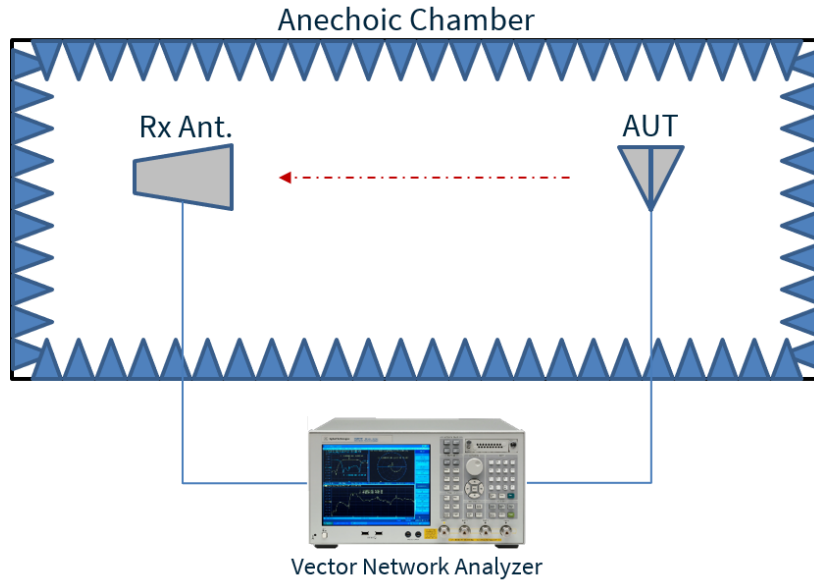

Free space

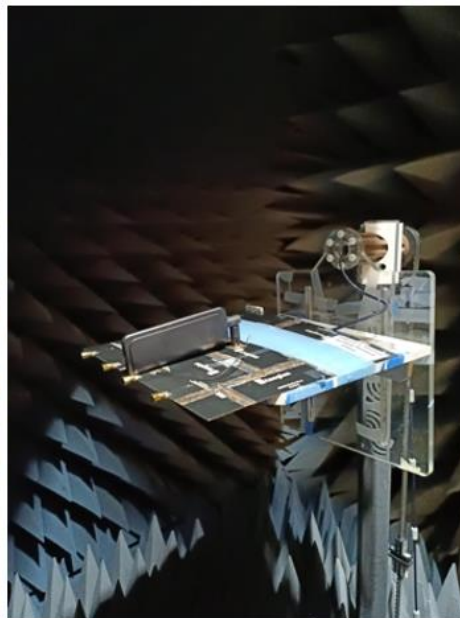

Ground plane (Centre)

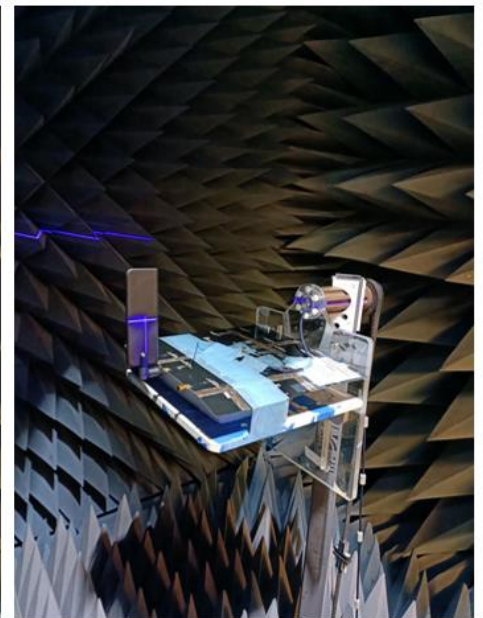

Ground plane (Edge)

4.2 30x30cm Ground Plane (Centre) - Patterns at 650 MHz

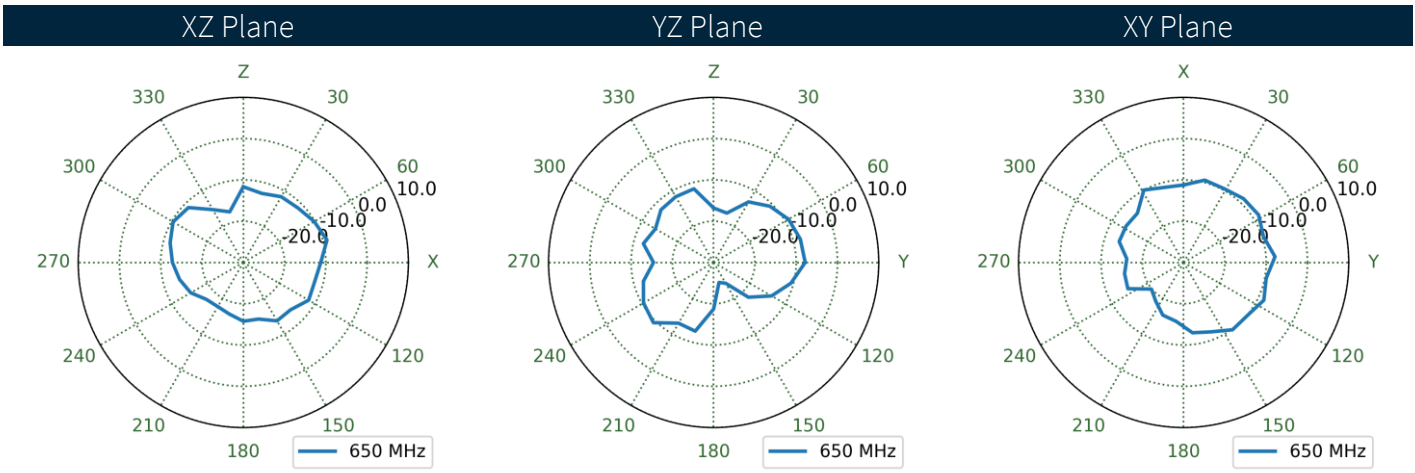
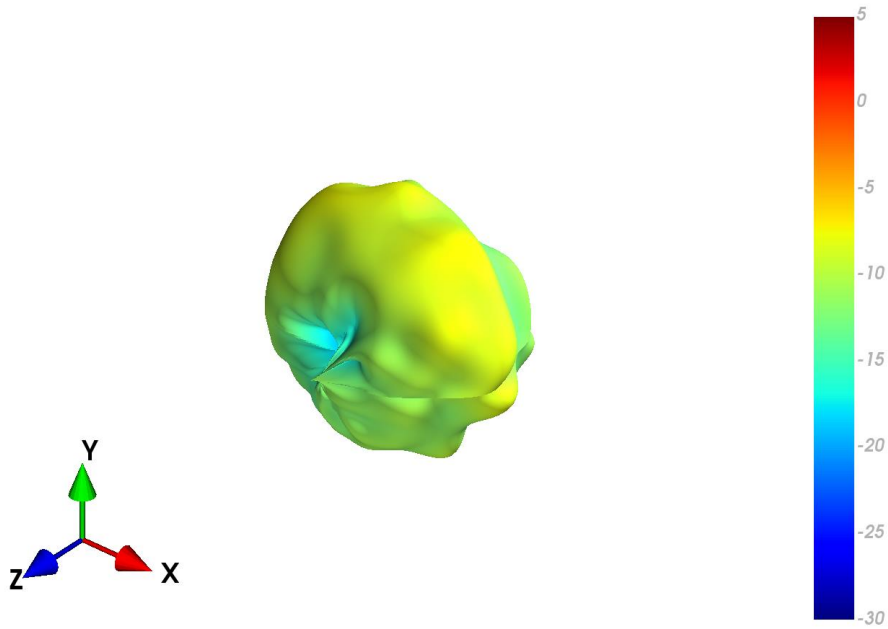

4.3 Free Space - Patterns at 650 MHz

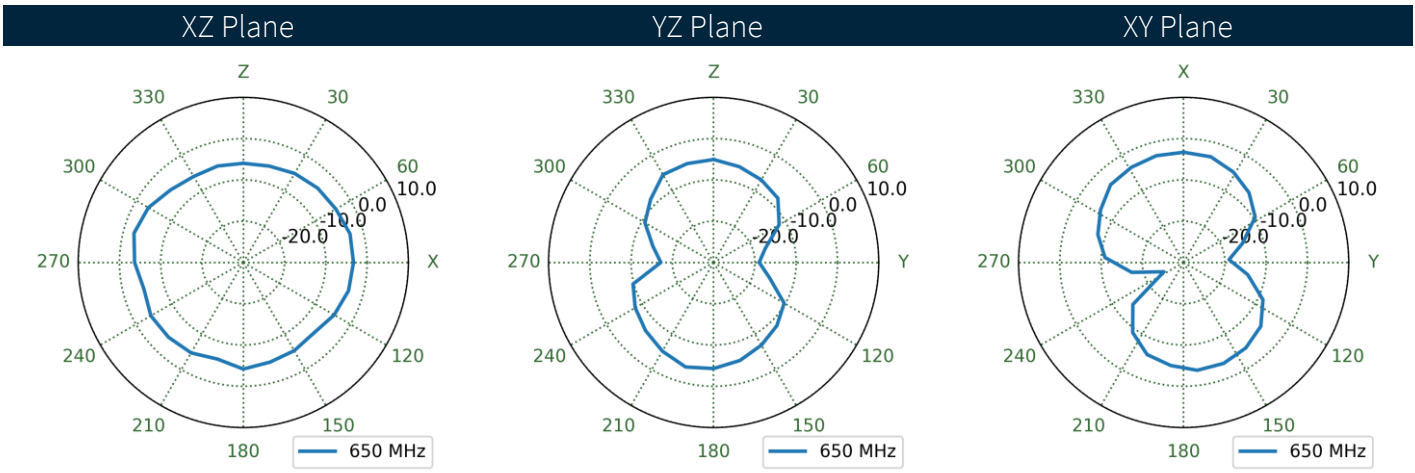
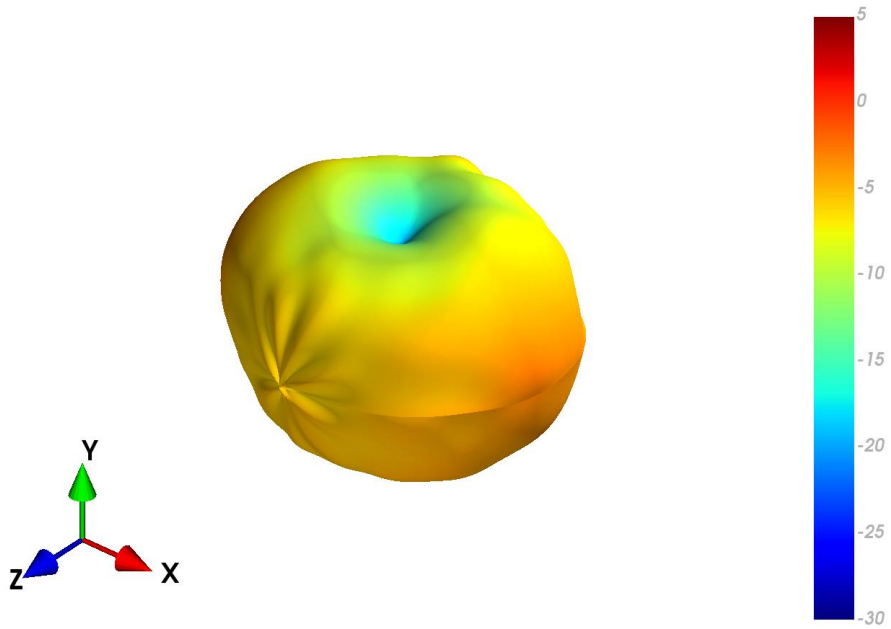

4.4 30x30cm Ground Plane (Edge) - Patterns at 650 MHz

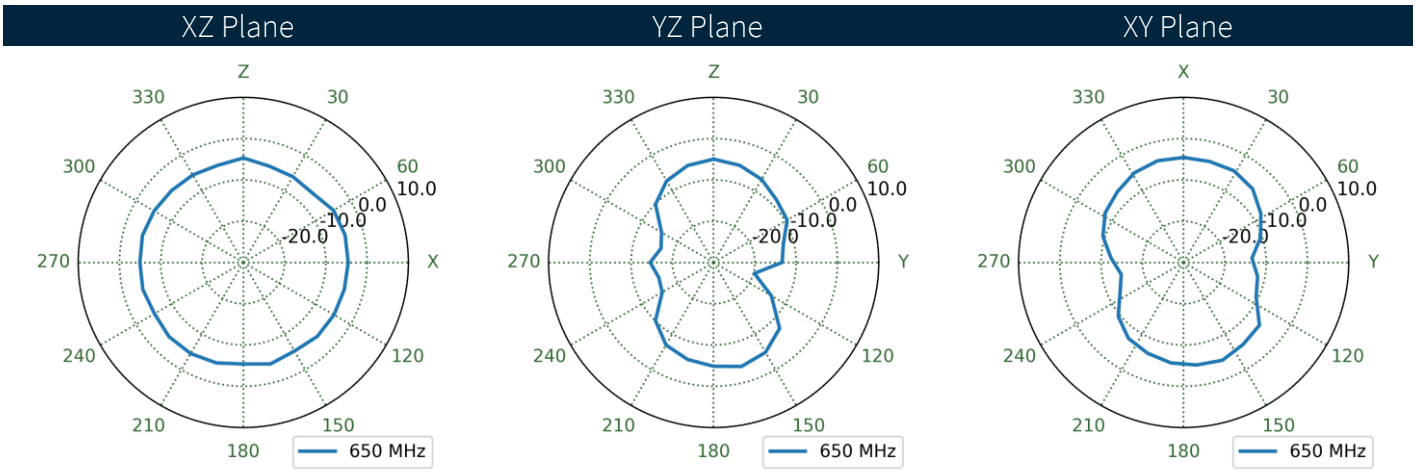
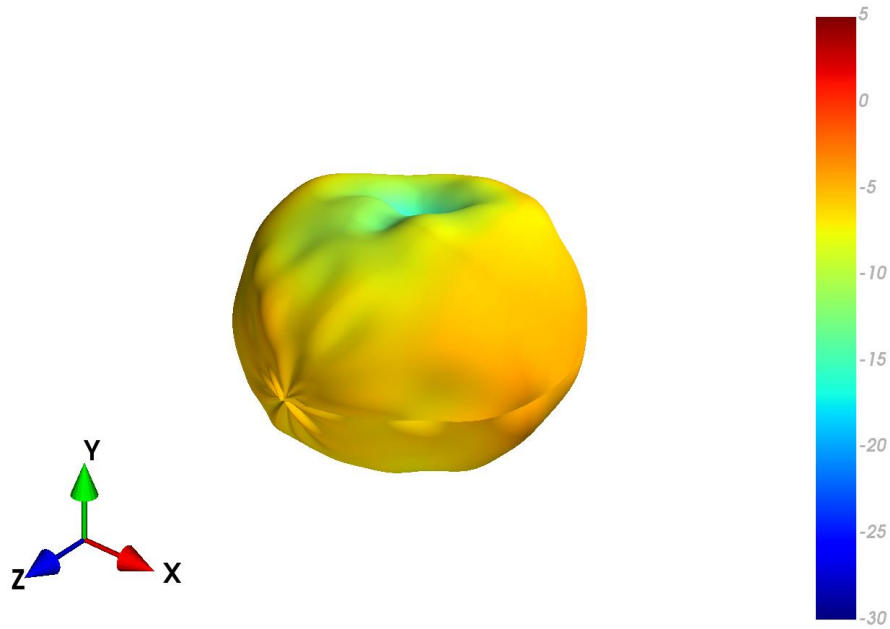

4.5 30x30cm Ground Plane (Centre) - Patterns at 750 MHz

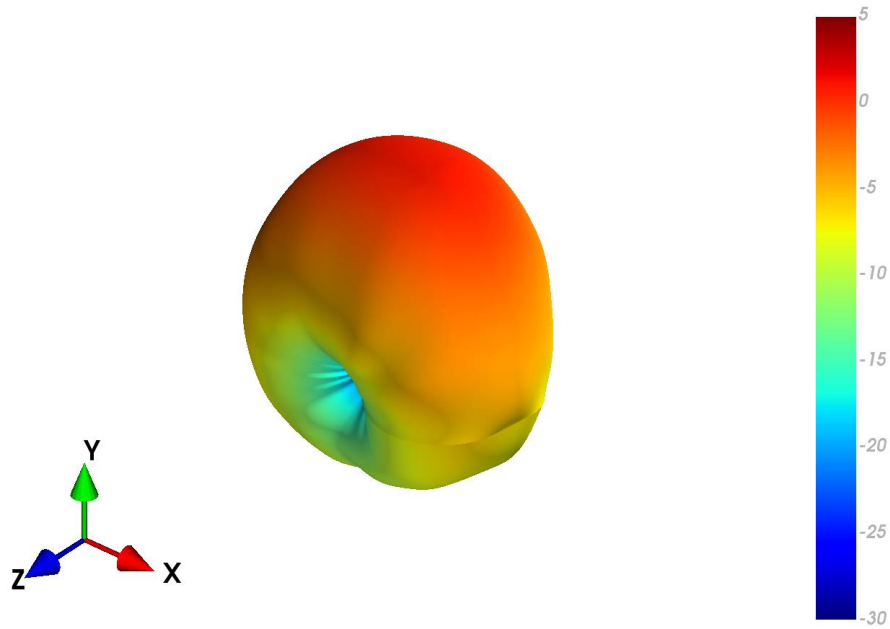

XZ Plane YZ Plane XY Plane

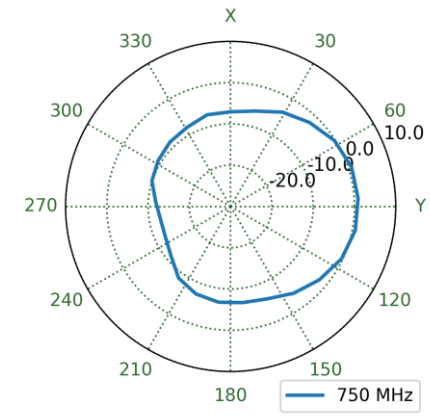
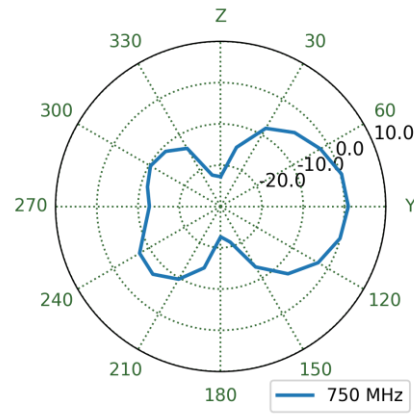
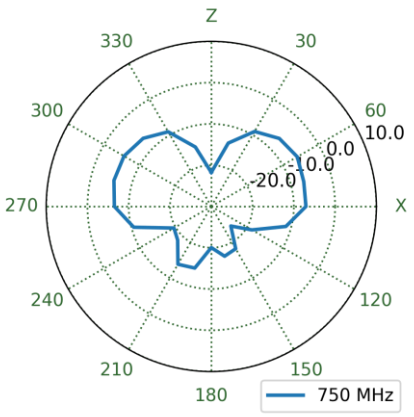

4.6 Free Space - Patterns at 750 MHz

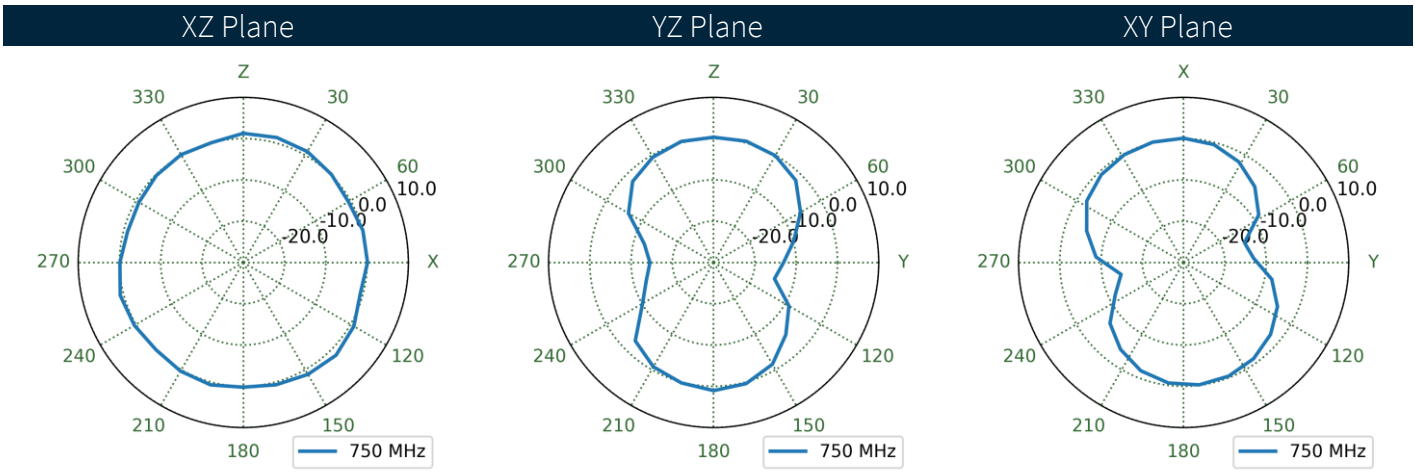
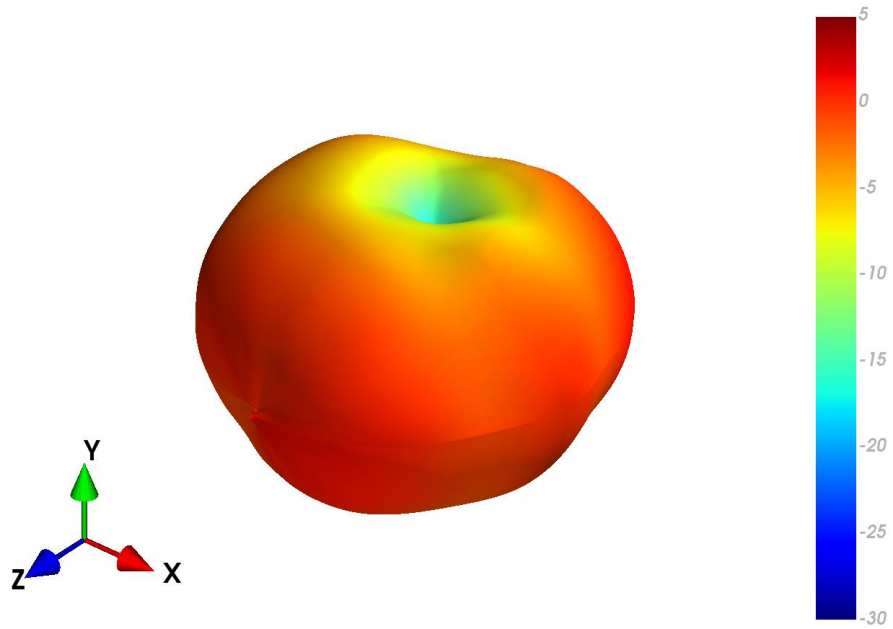

4.7 30x30cm Ground Plane (Edge) - Patterns at 750 MHz

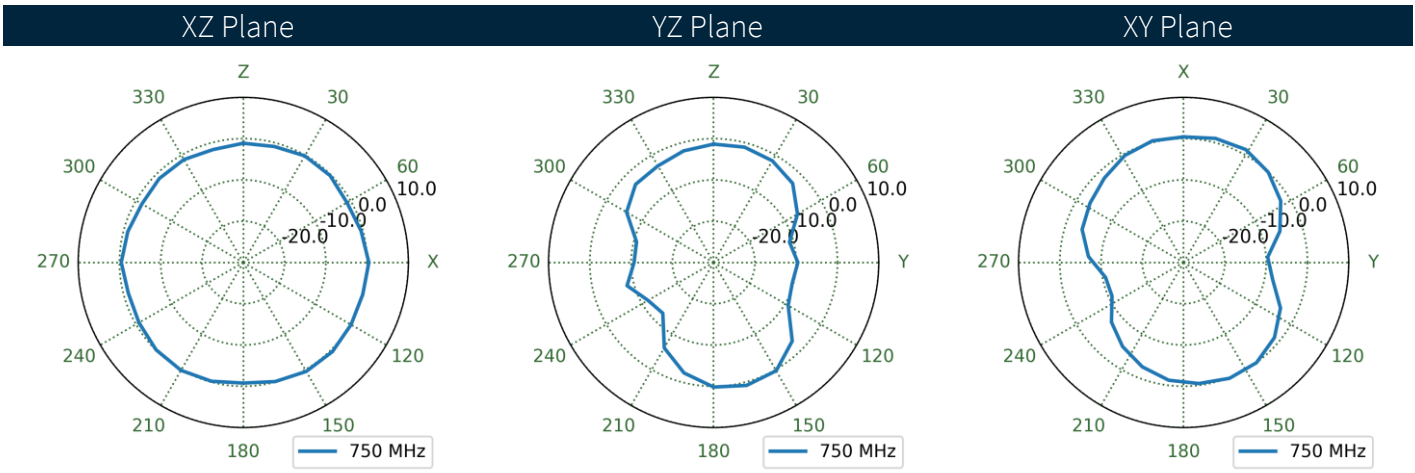
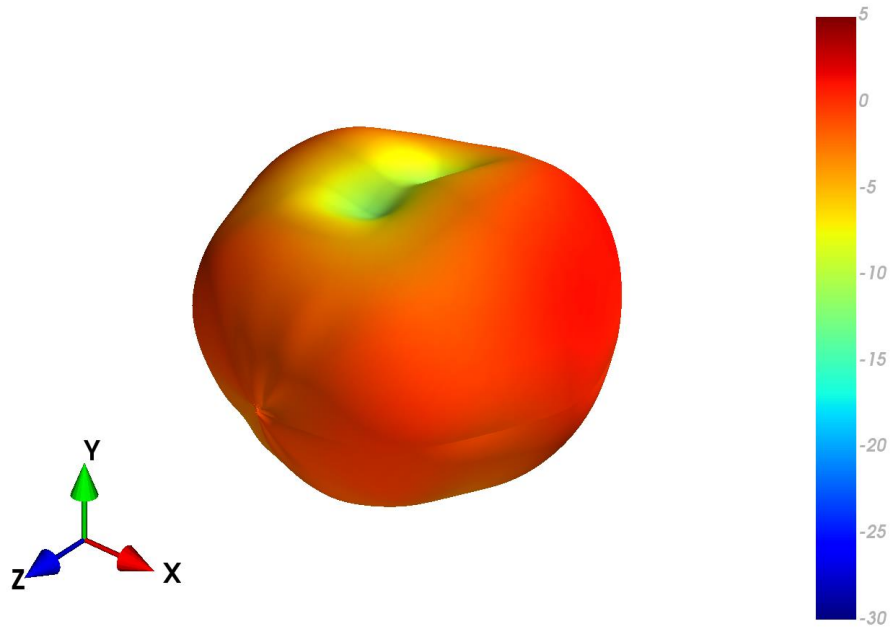

4.8 30x30cm Ground Plane (Centre) - Patterns at 890 MHz

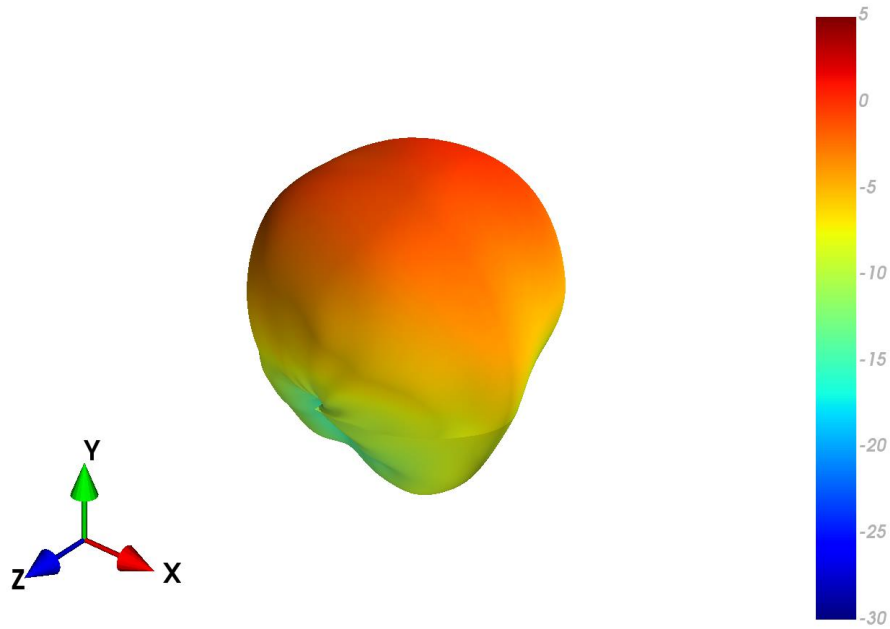

XZ Plane YZ Plane XY Plane

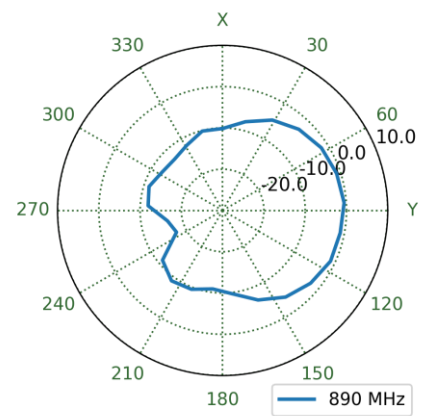
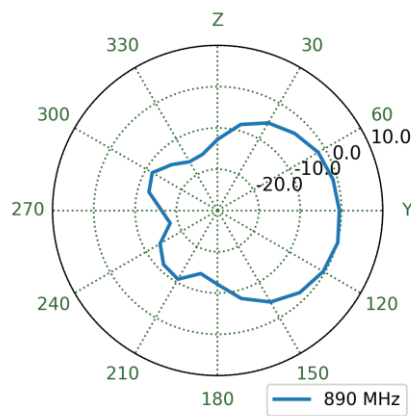
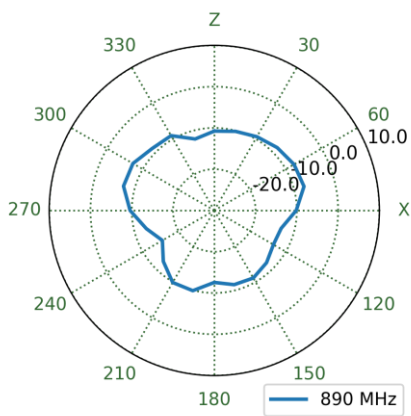

4.9 Free Space - Patterns at 890 MHz

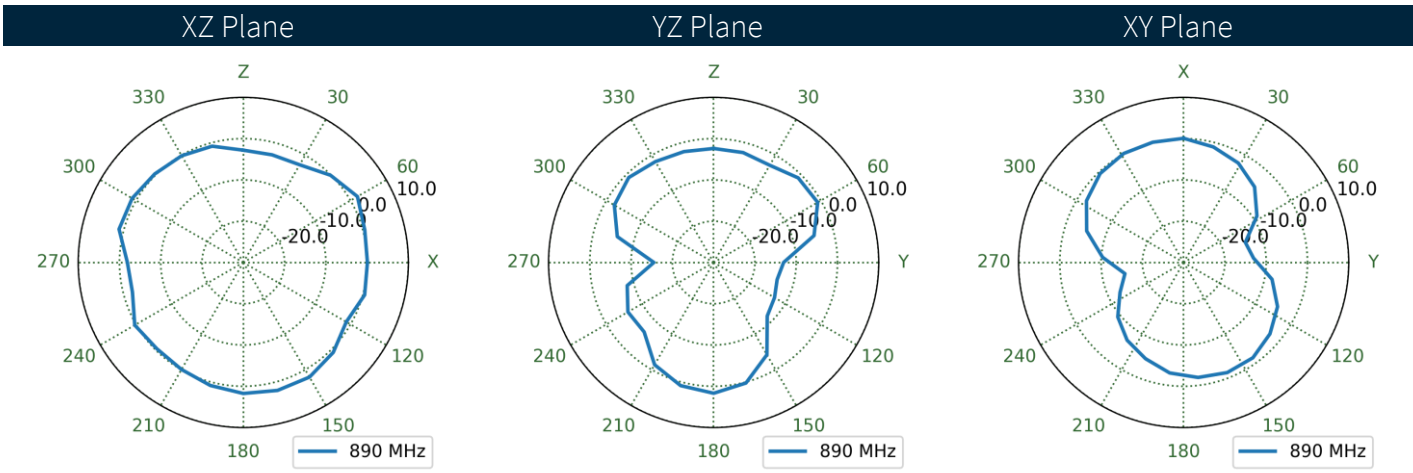
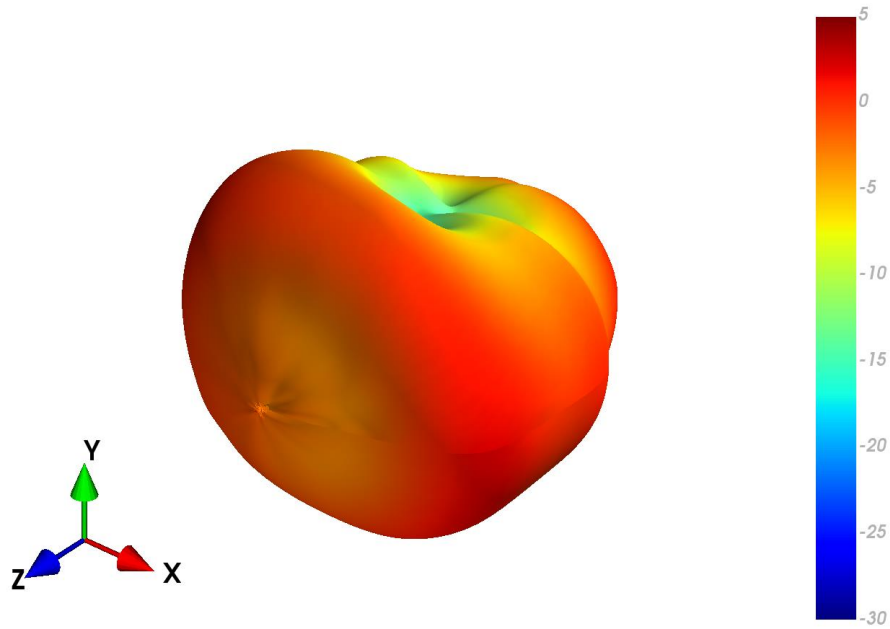

4.10 30x30cm Ground Plane (Edge) - Patterns at 890 MHz

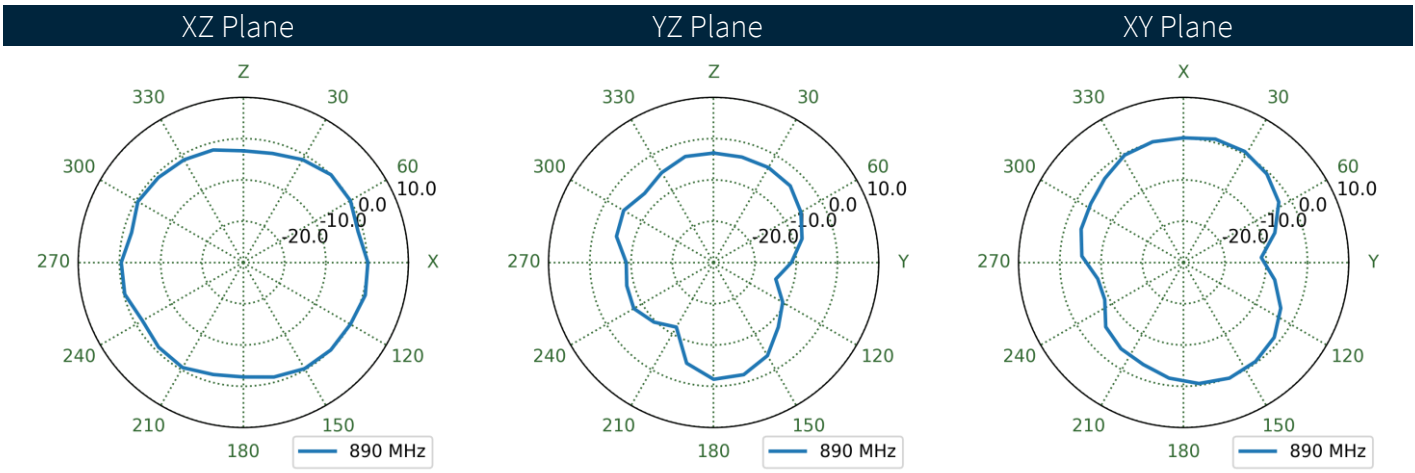
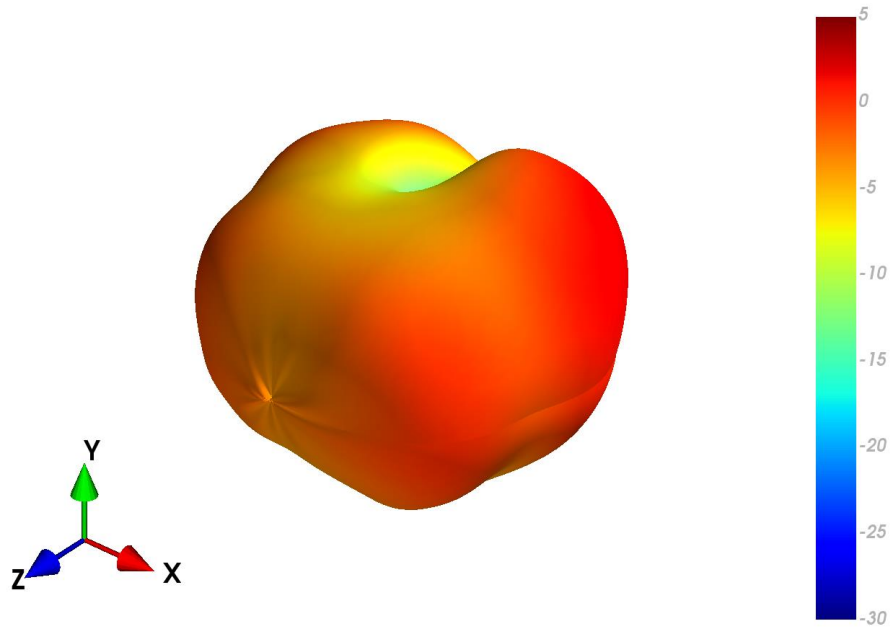

4.11 30x30cm Ground Plane (Centre) - Patterns at 960 MHz

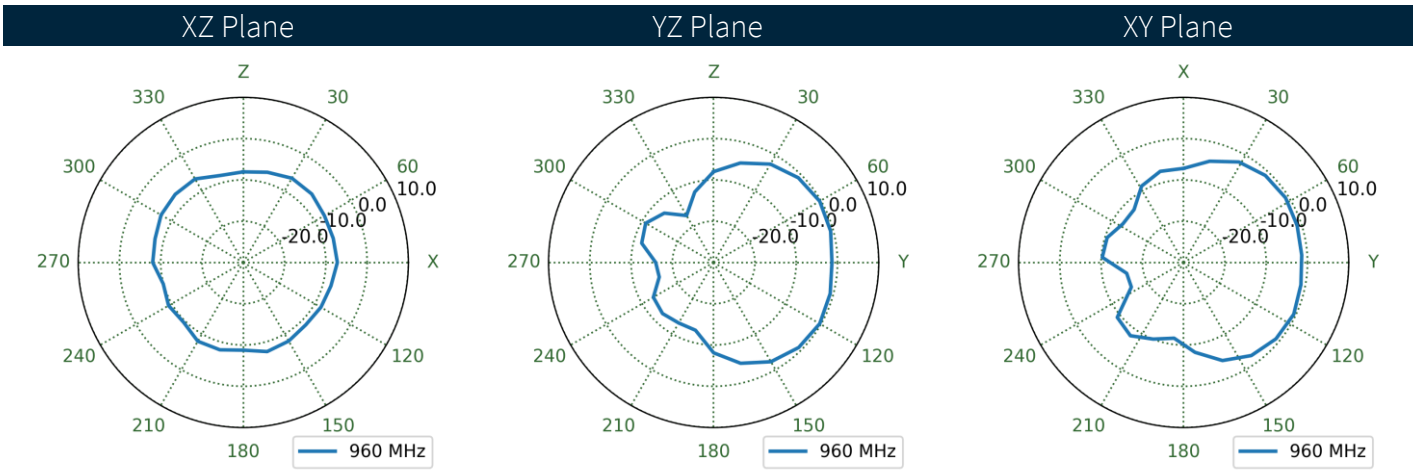
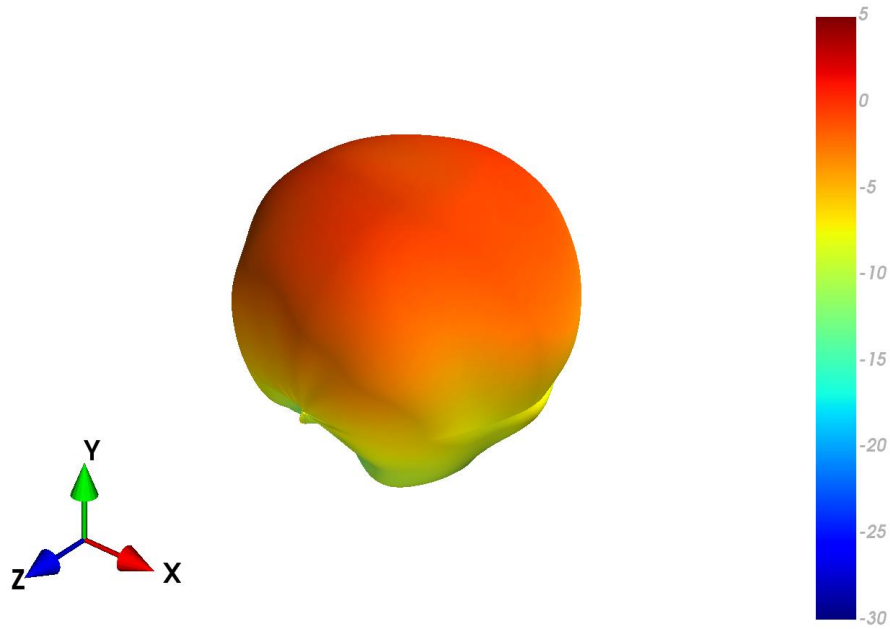

4.12 Free Space - Patterns at 960 MHz

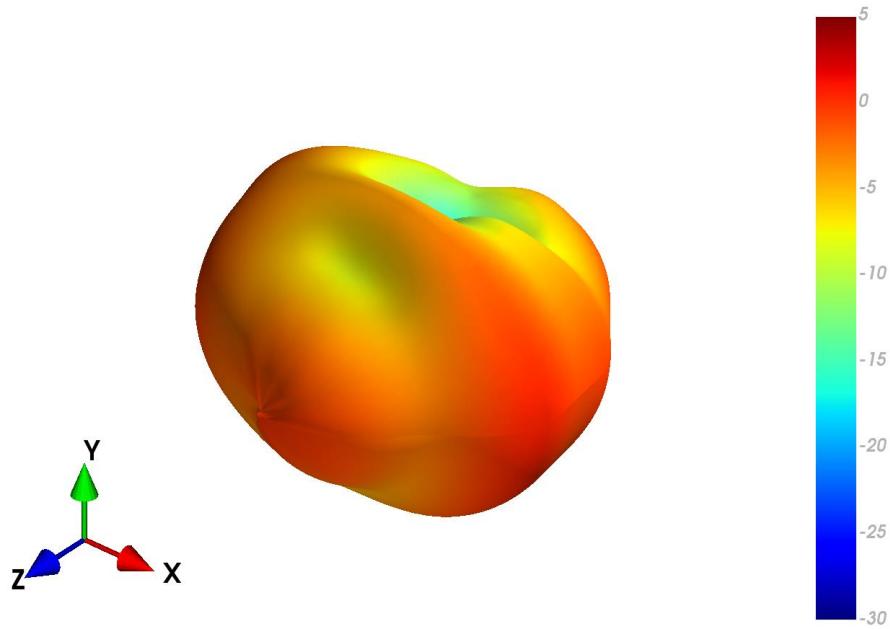

XZ Plane YZ Plane XY Plane

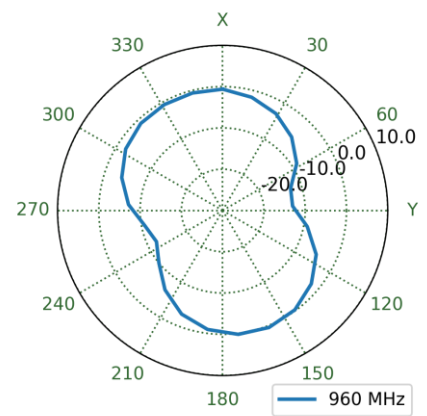
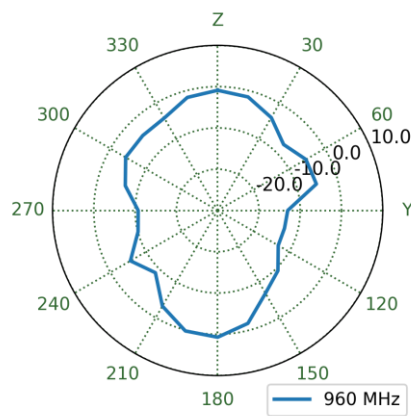
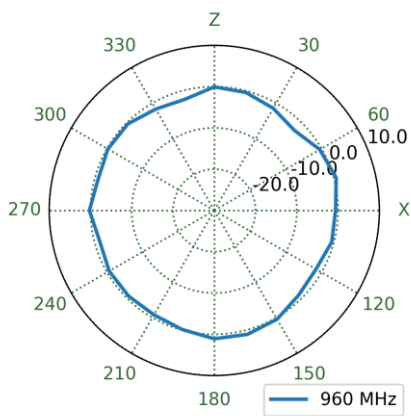

4.13 30x30cm Ground Plane (Edge) - Patterns at 960 MHz

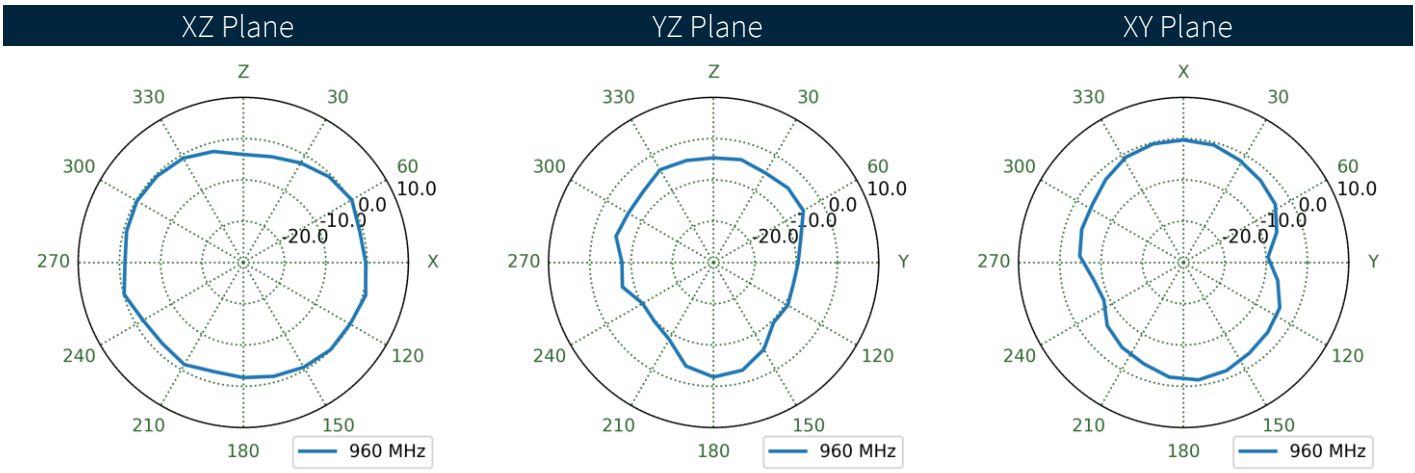
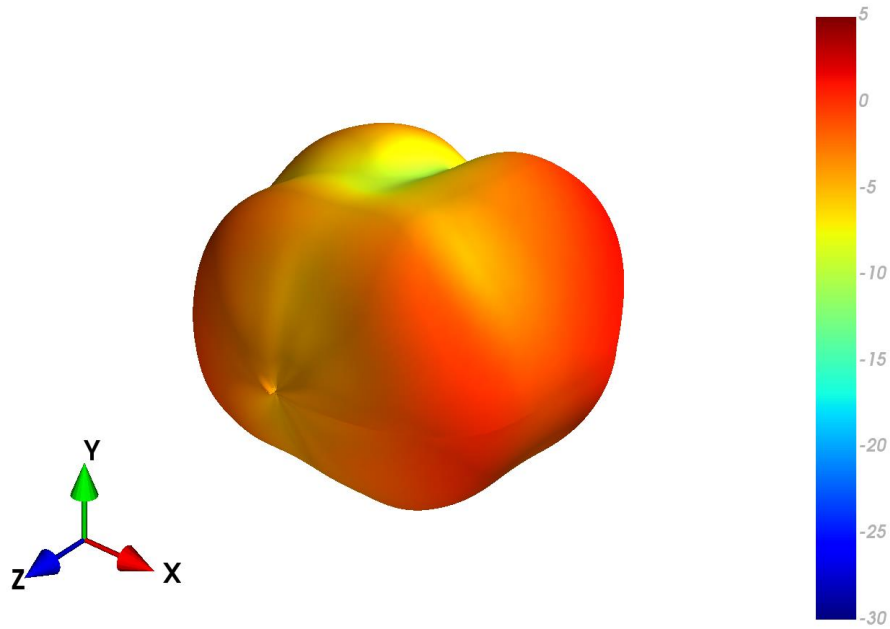

4.14 30x30cm Ground Plane (Centre) - Patterns at 1470 MHz

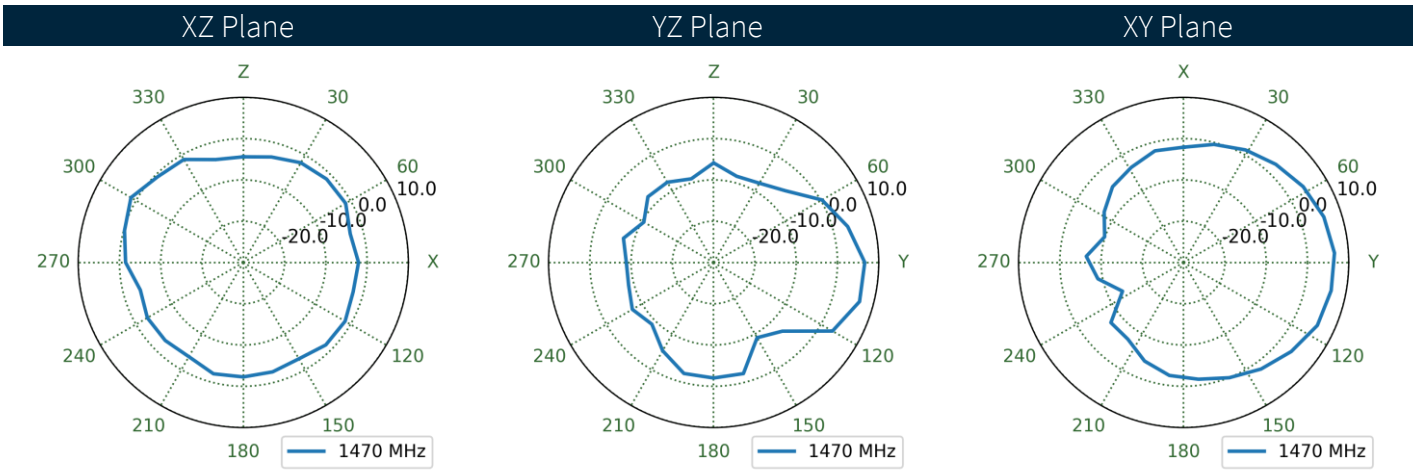
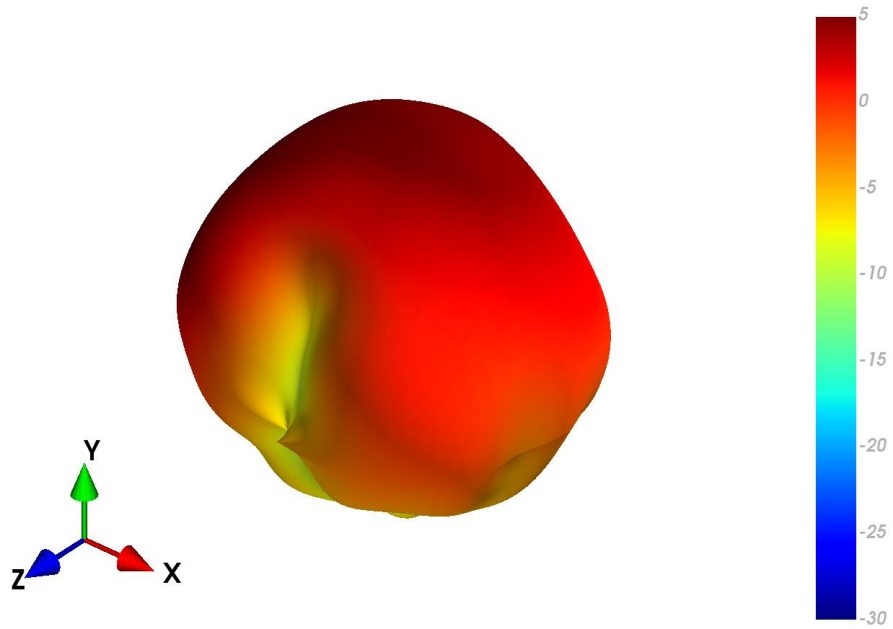

4.15 Free Space - Patterns at 1470 MHz

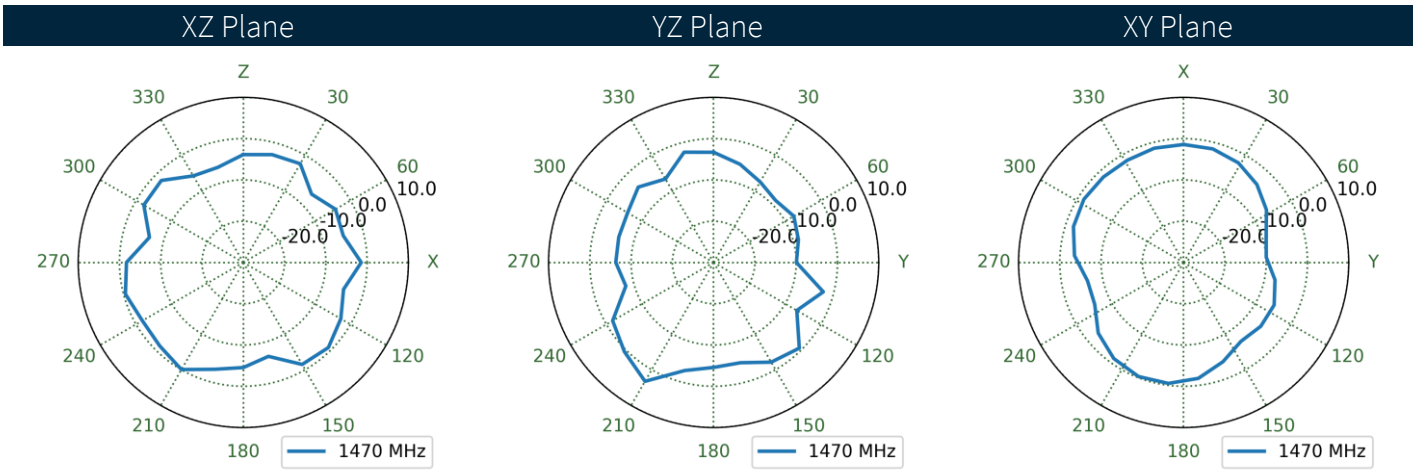
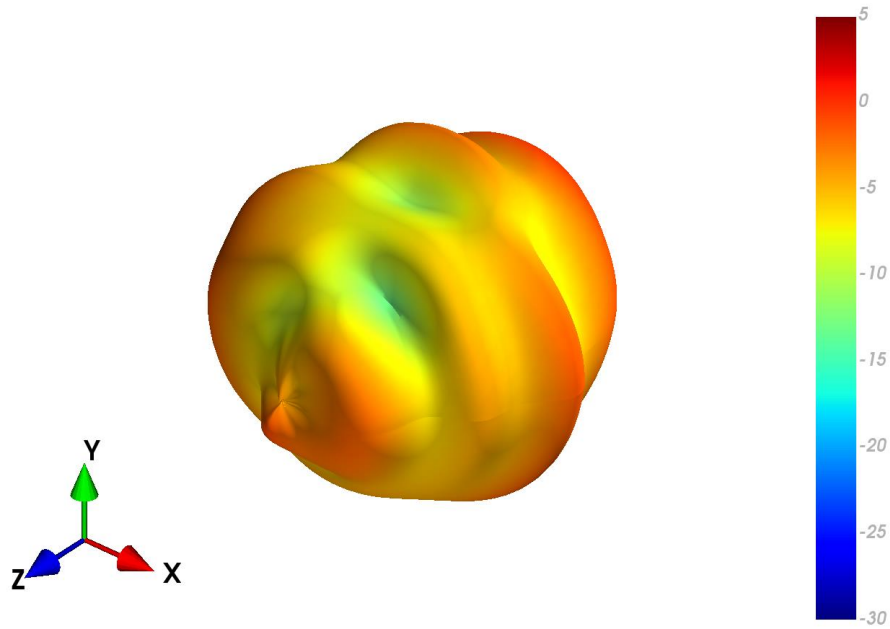

4.16 30x30cm Ground Plane (Edge) - Patterns at 1470 MHz

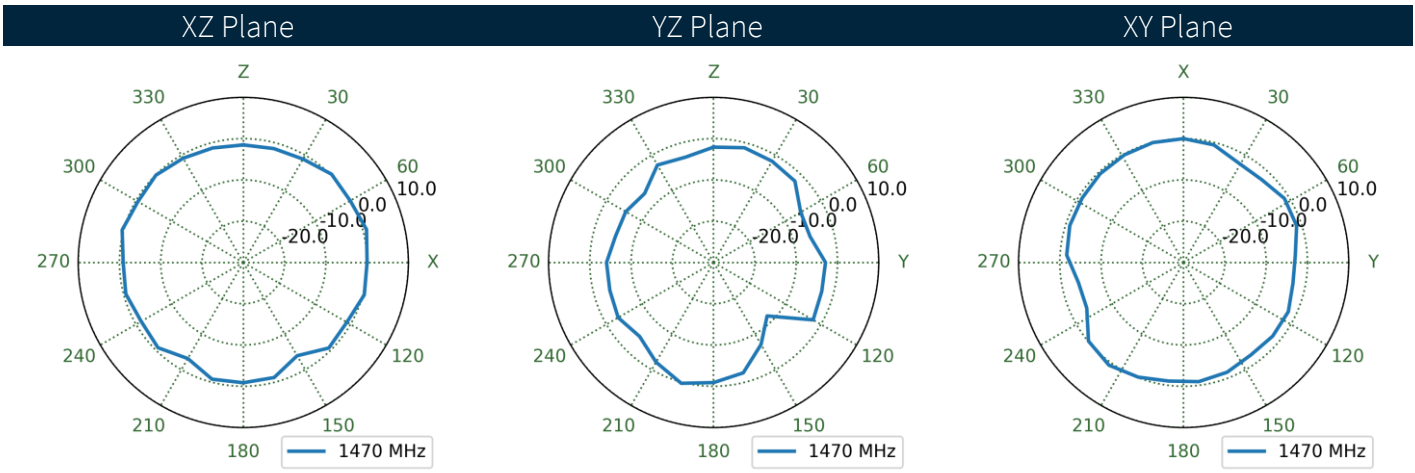
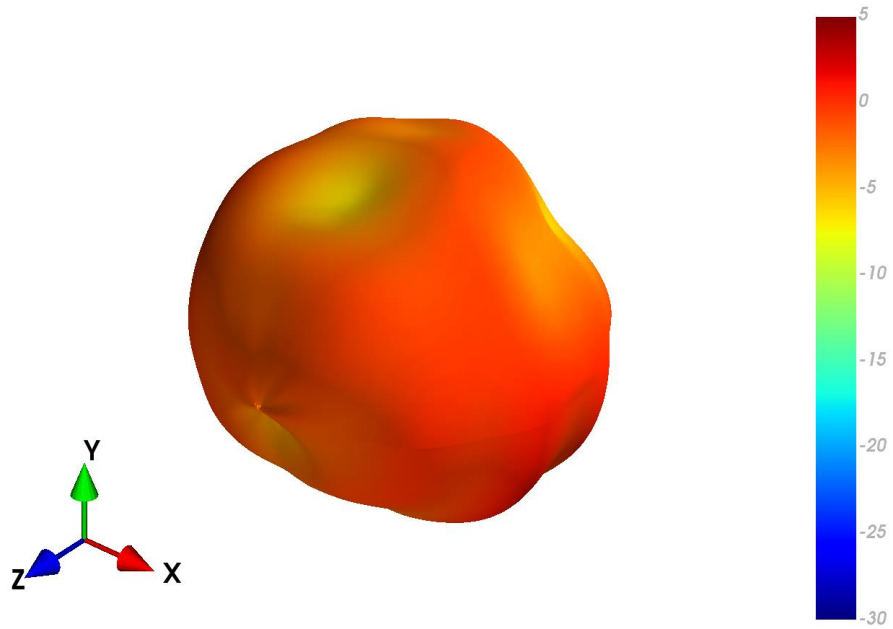

4.17 30x30cm Ground Plane (Centre) - Patterns at 1805 MHz

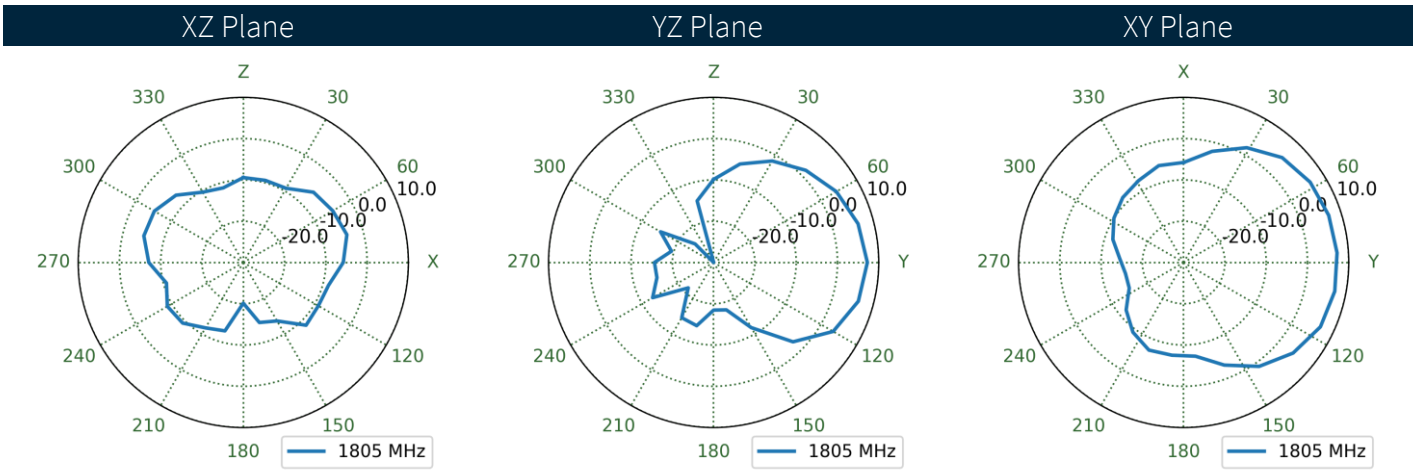
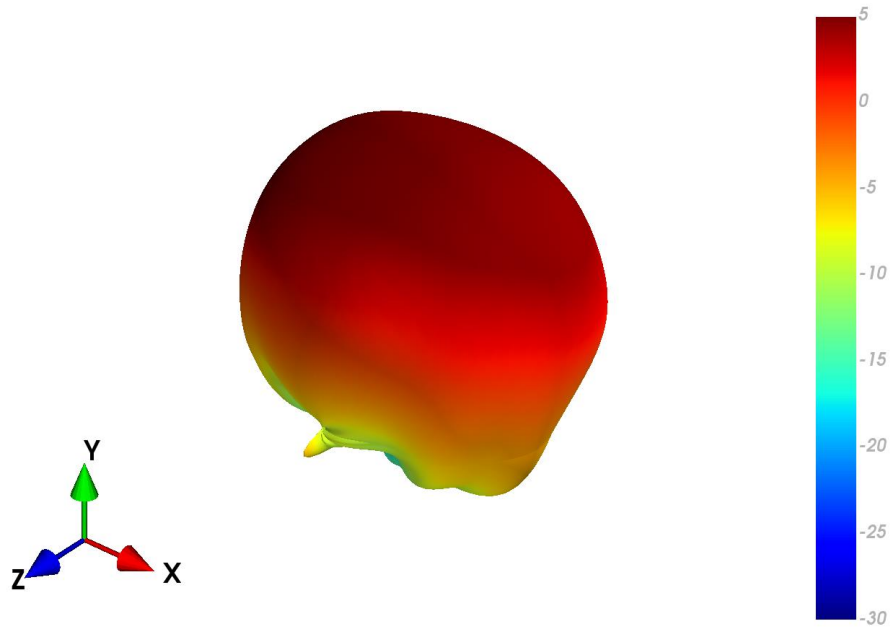

4.18 Free Space - Patterns at 1805 MHz

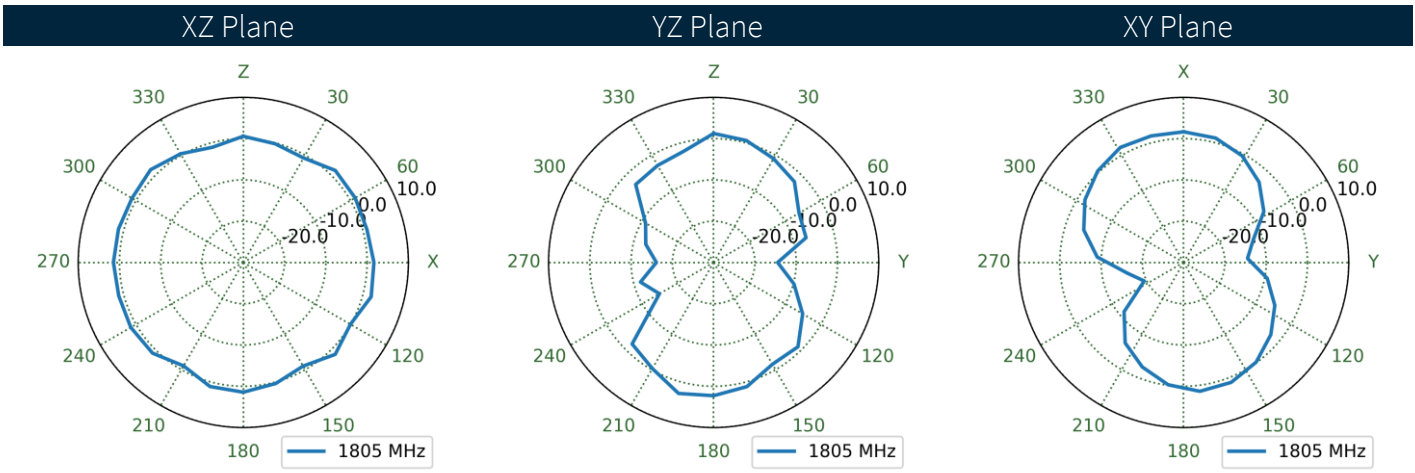
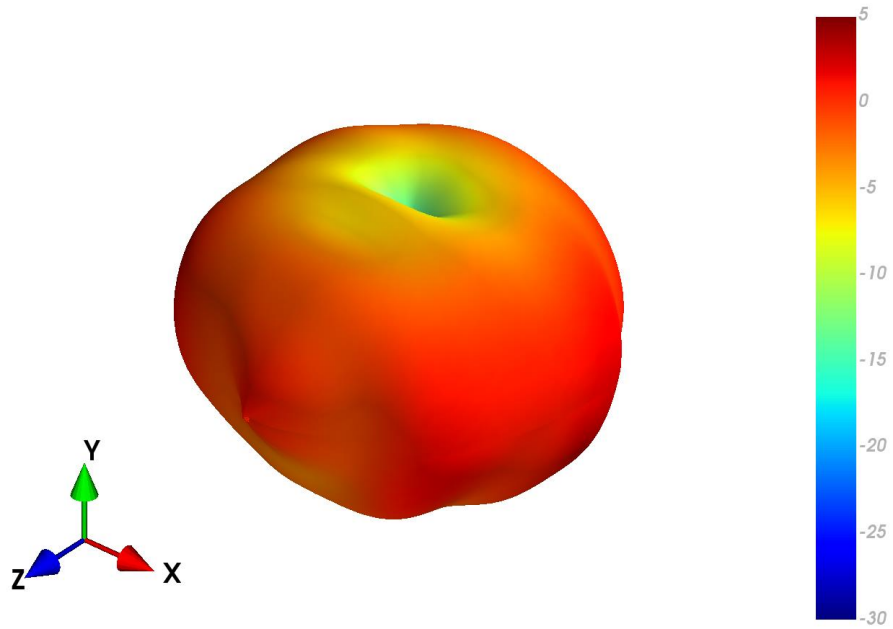

4.19 30x30cm Ground Plane (Edge) - Patterns at 1805 MHz

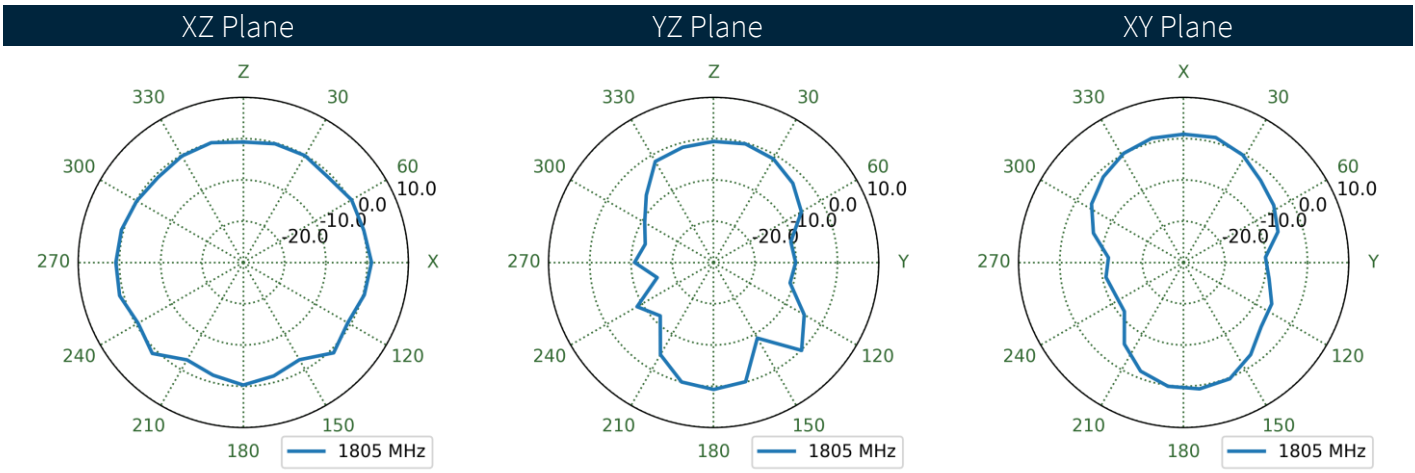
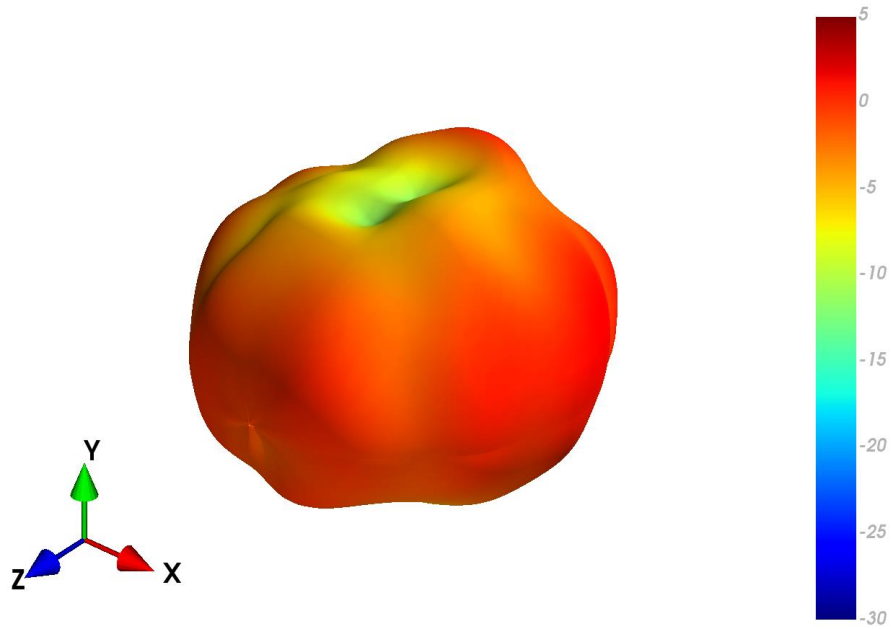

4.20 30x30cm Ground Plane (Centre) - Patterns at 1920 MHz

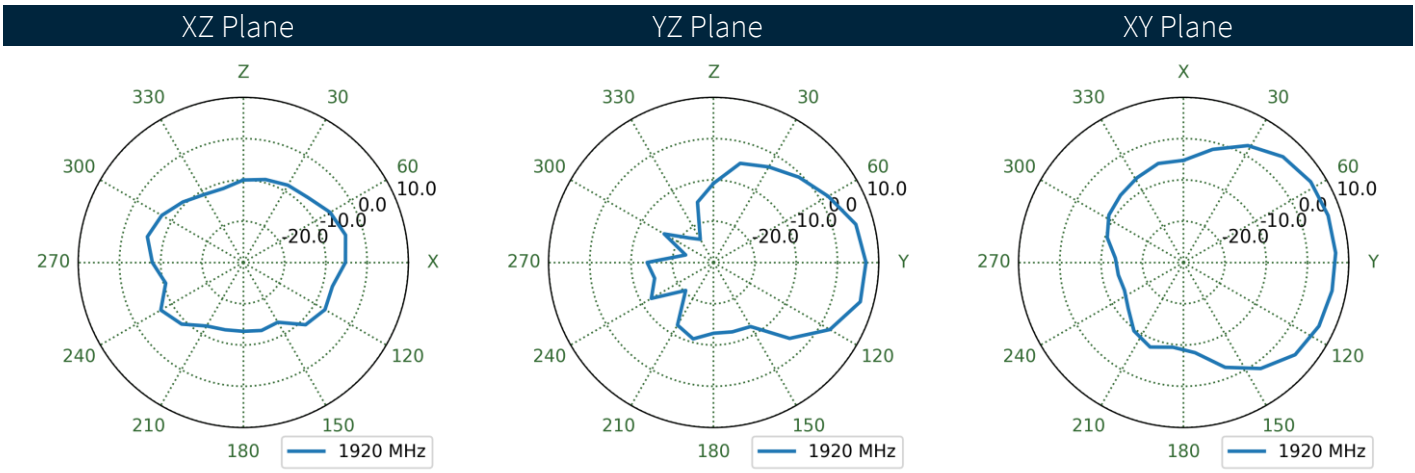
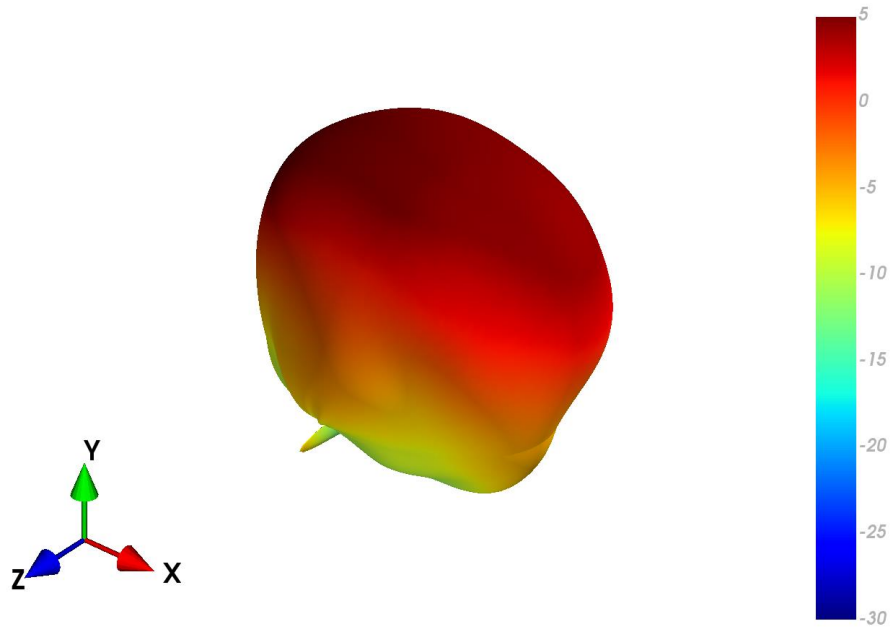

4.21 Free Space - Patterns at 1920 MHz

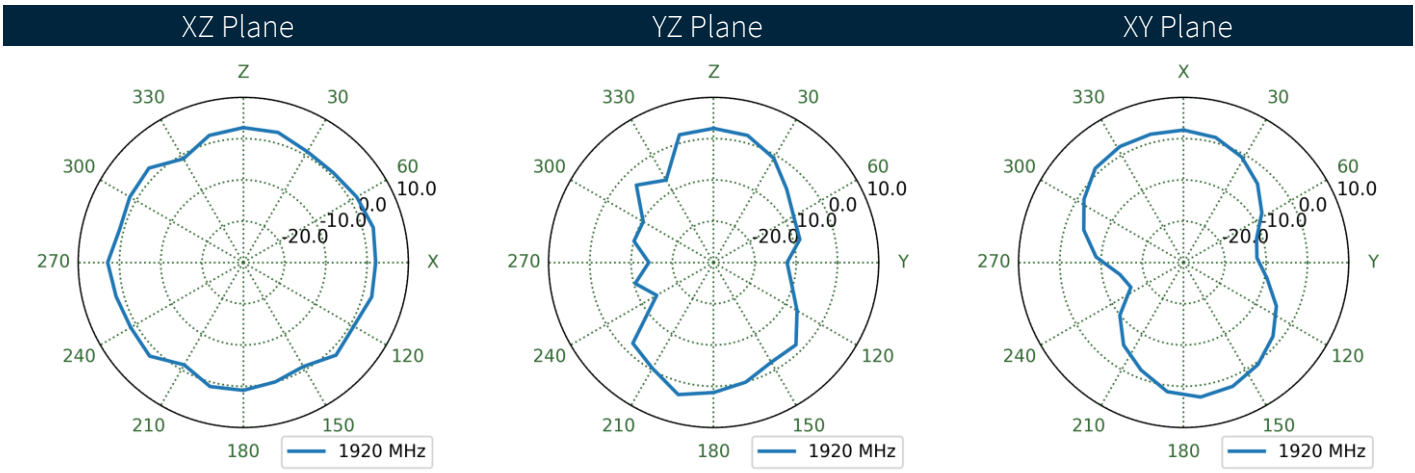
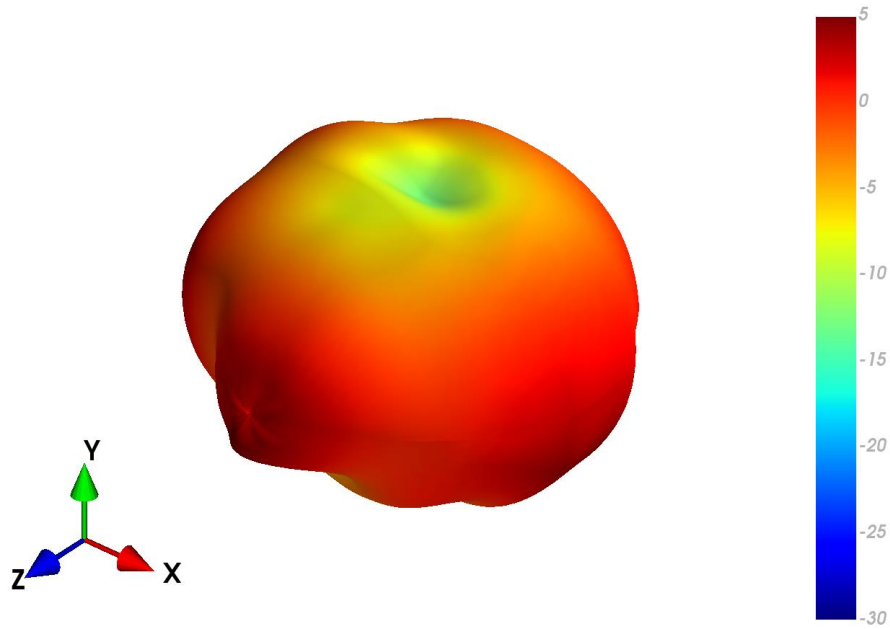

4.22 30x30cm Ground Plane (Edge) - Patterns at 1920 MHz

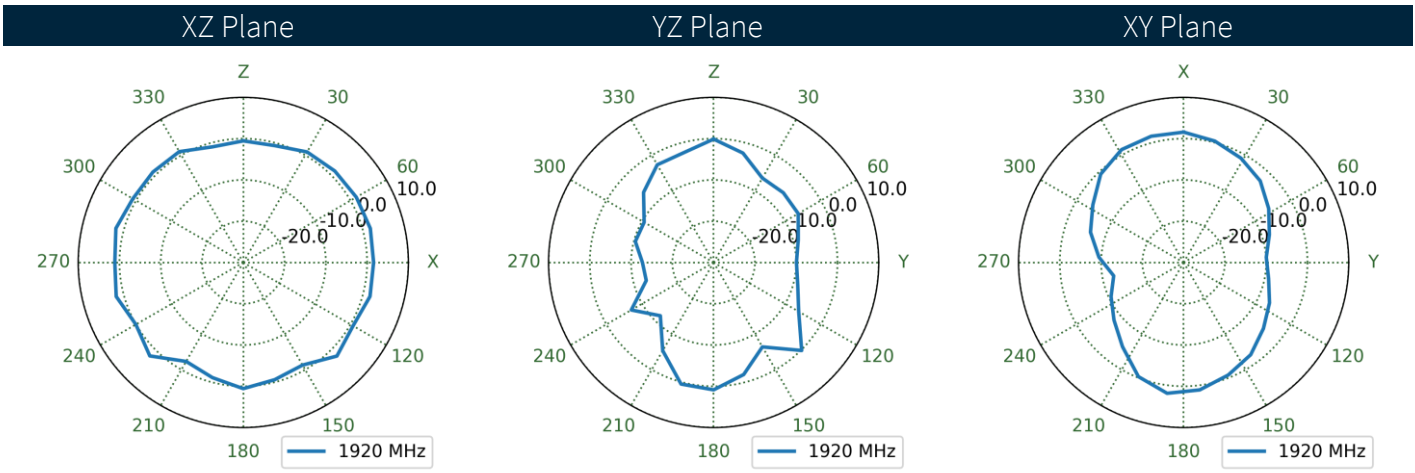
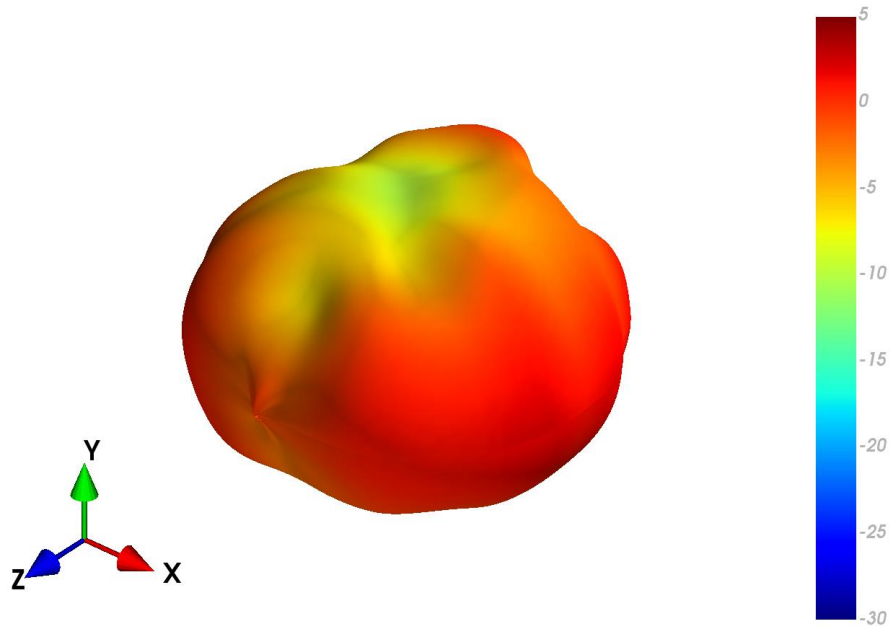

4.23 30x30cm Ground Plane (Centre) - Patterns at 2595 MHz

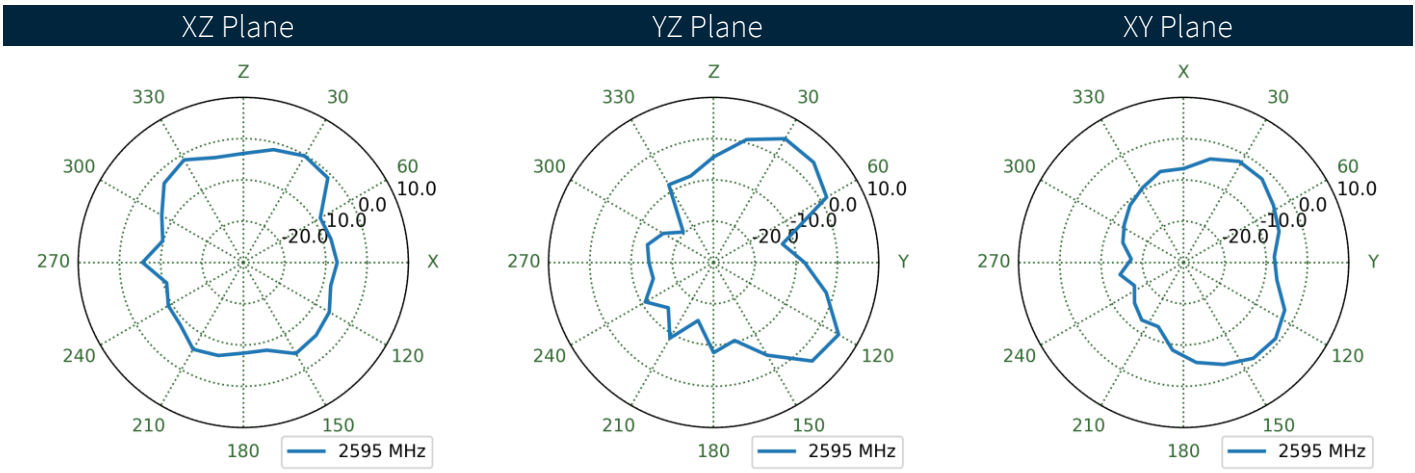
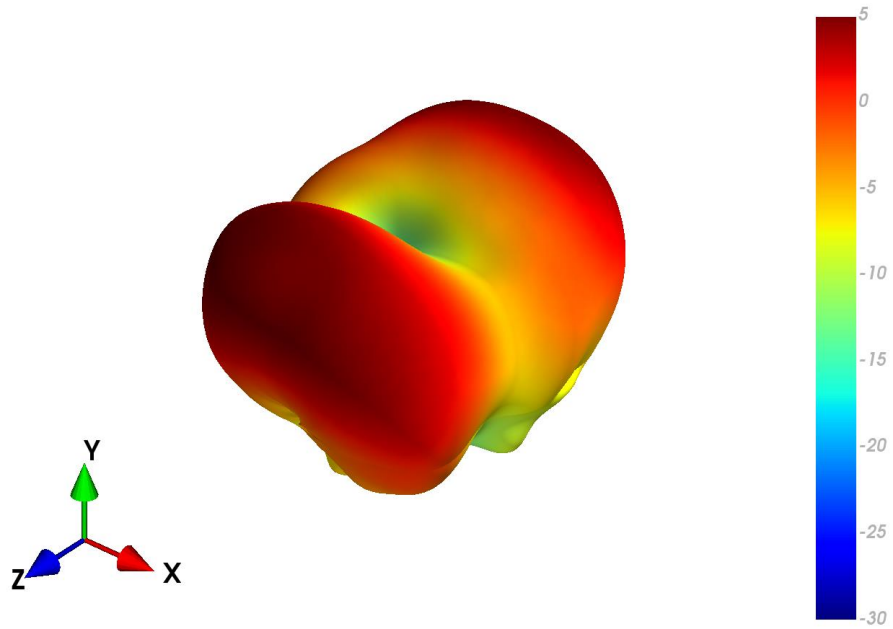

4.24 Free Space - Patterns at 2595 MHz

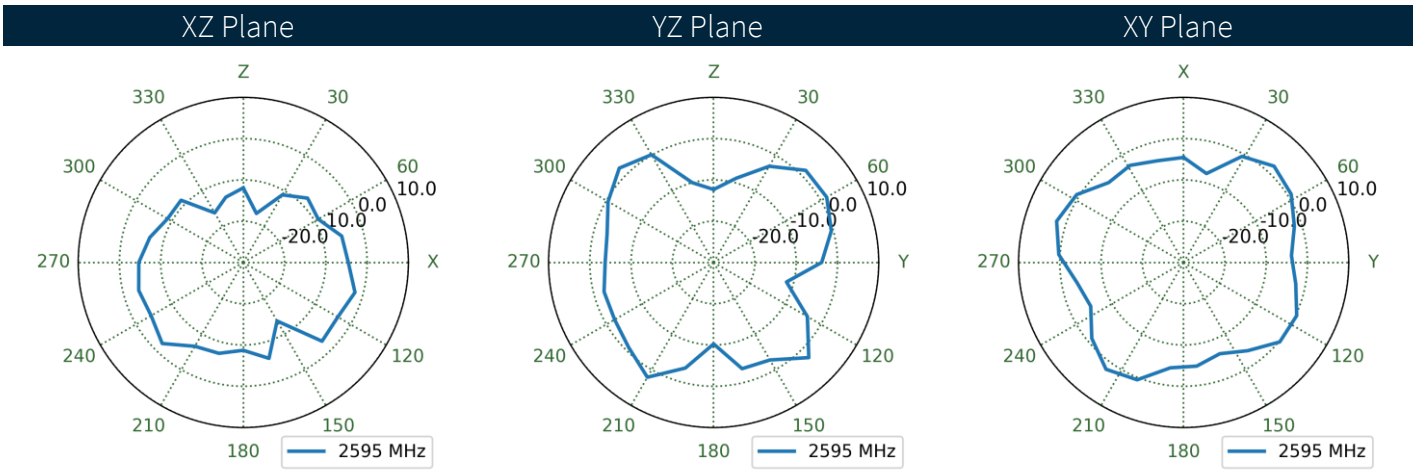
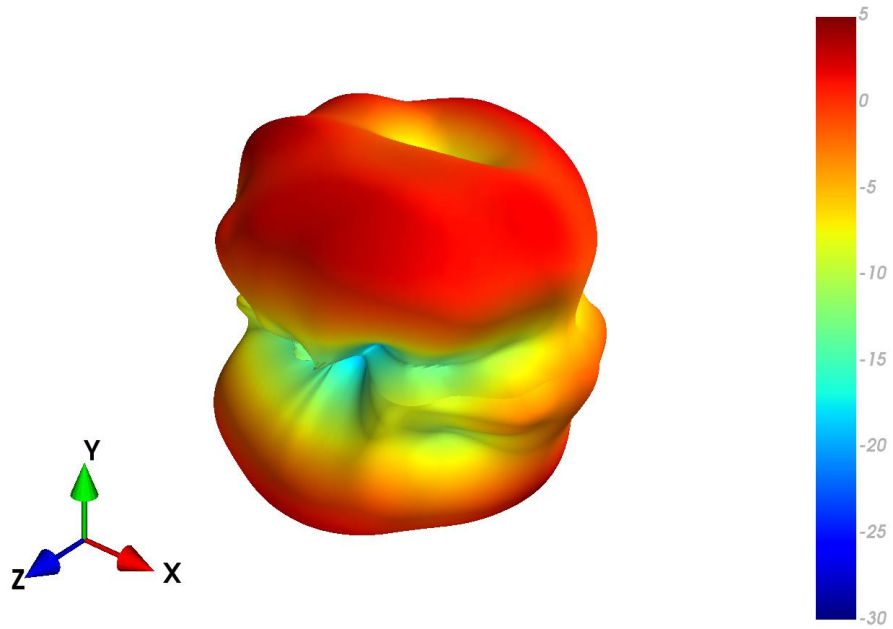

4.25 30x30cm Ground Plane (Edge) - Patterns at 2595 MHz

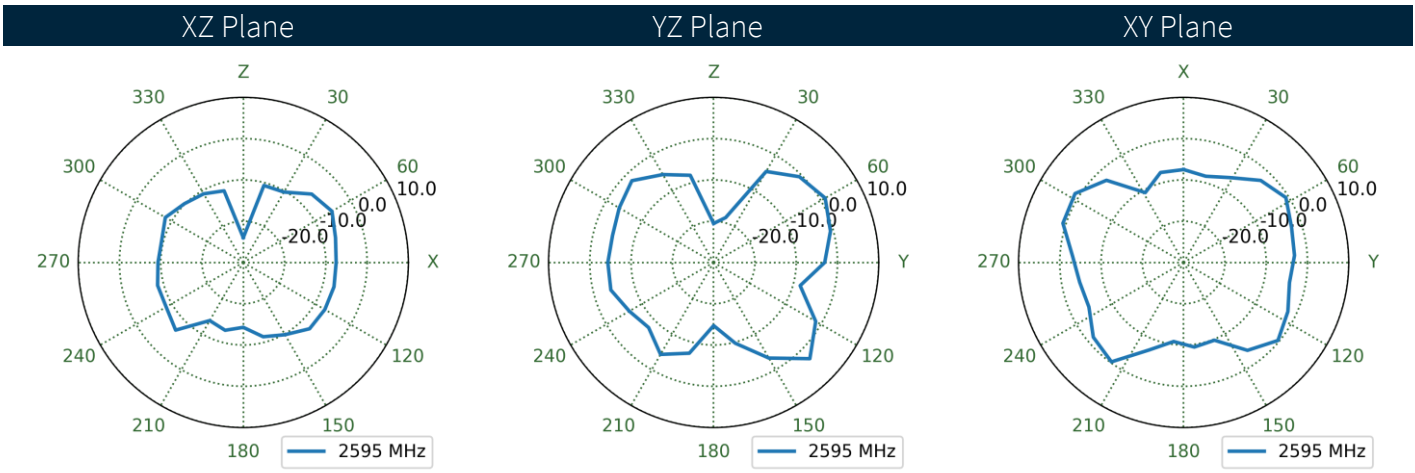
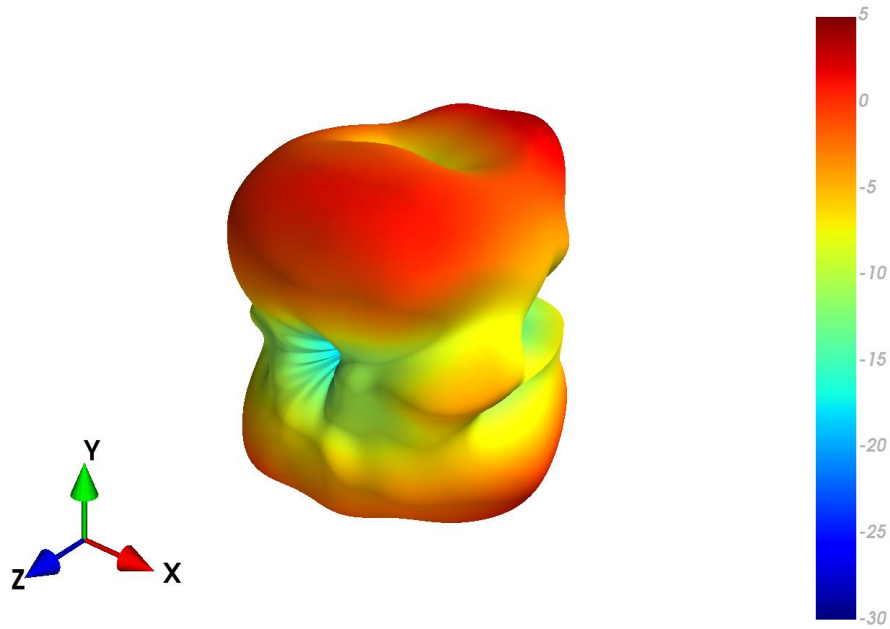

4.26 30x30cm Ground Plane (Centre) - Patterns at 3500 MHz

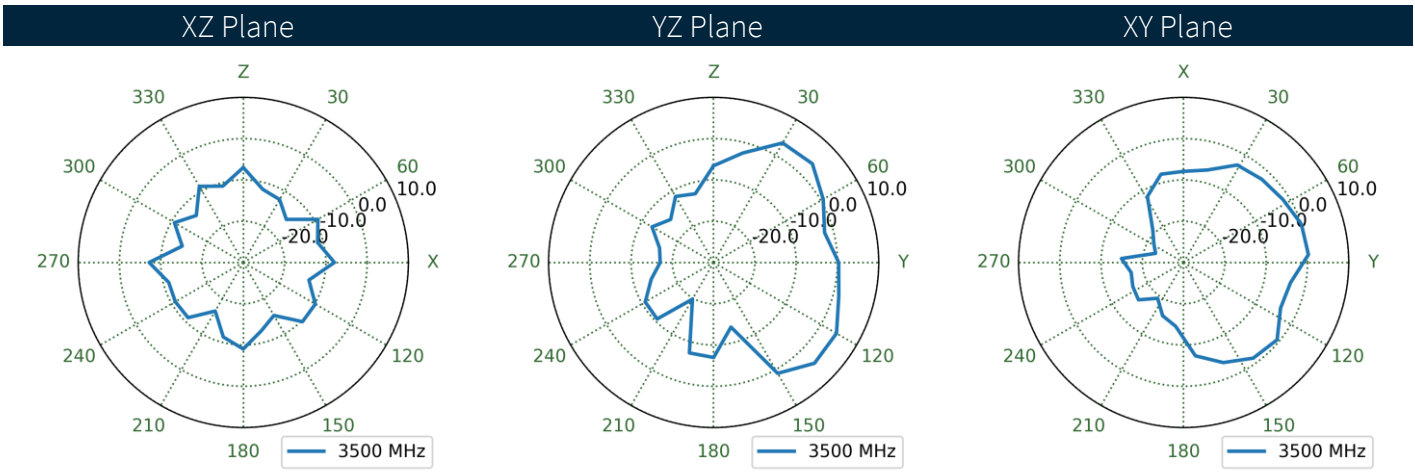
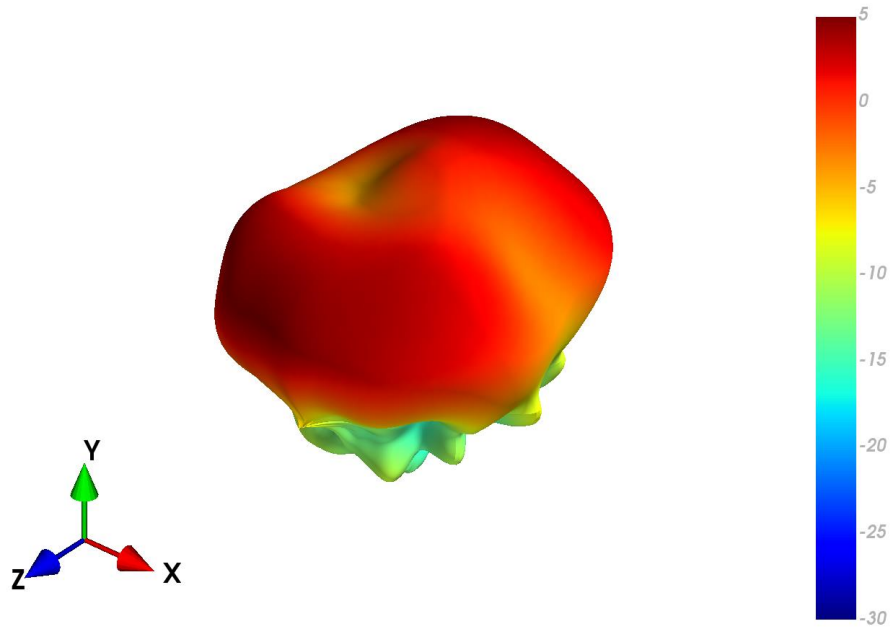

4.27 Free Space - Patterns at 3500 MHz

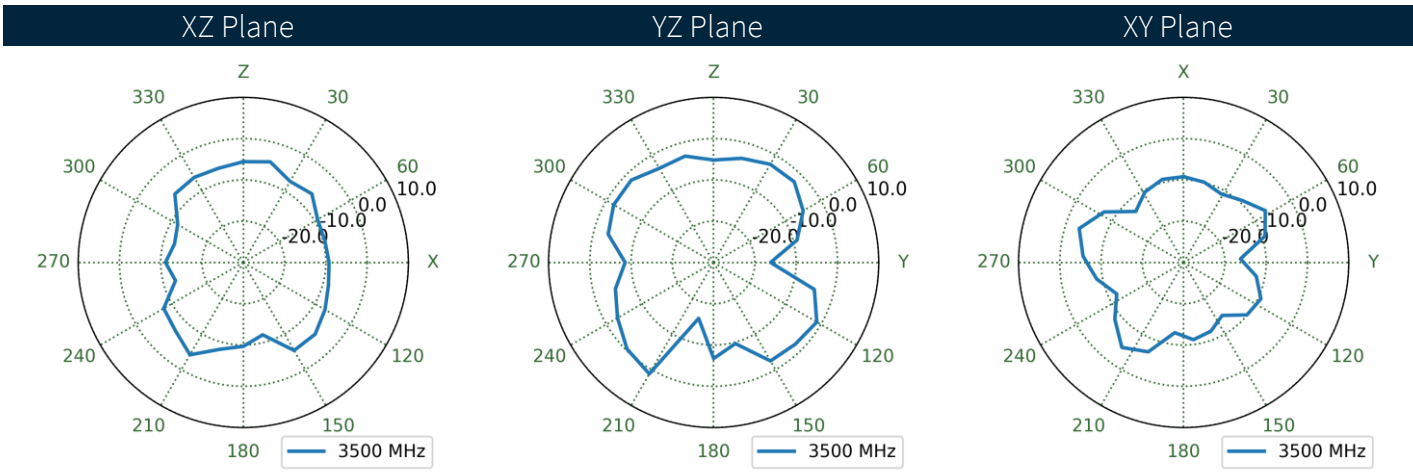
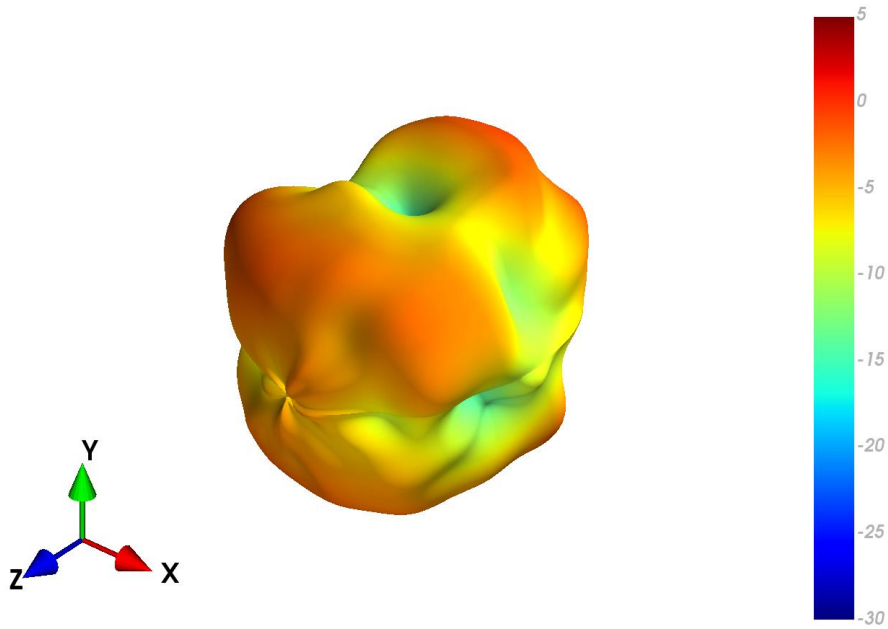

4.28 30x30cm Ground Plane (Edge) - Patterns at 3500 MHz

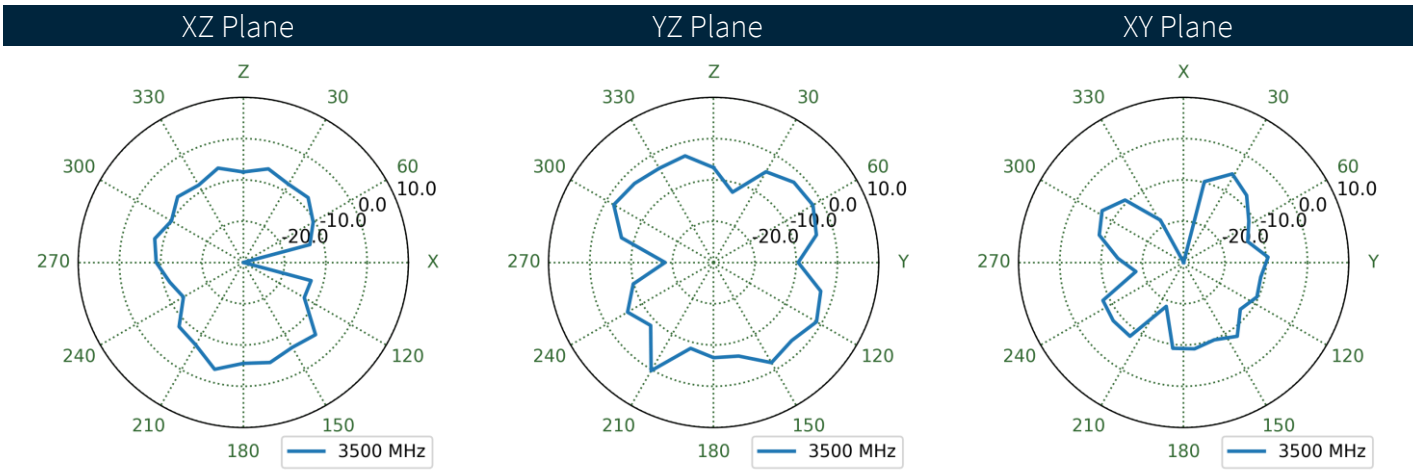
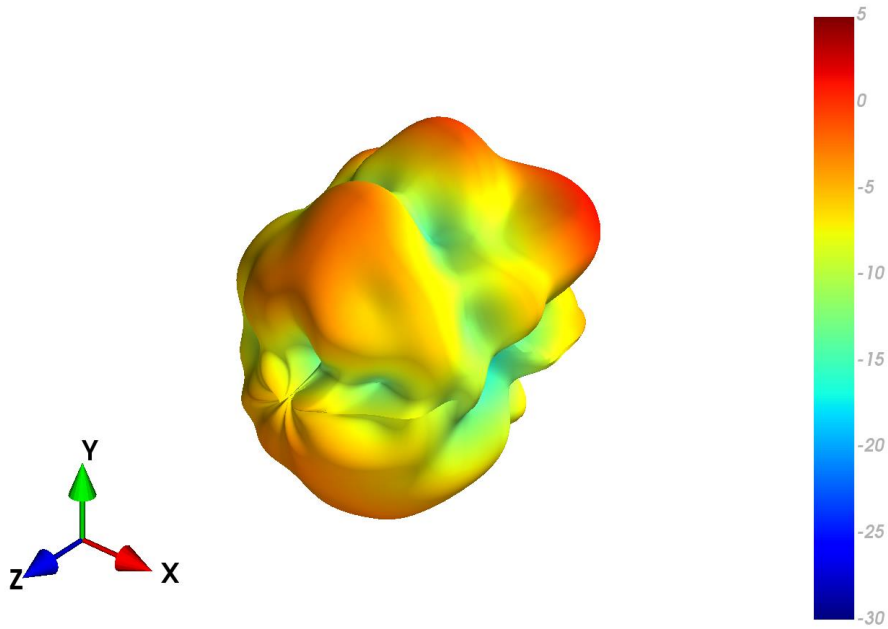

4.29 30x30cm Ground Plane (Centre) - Patterns at 5150 MHz

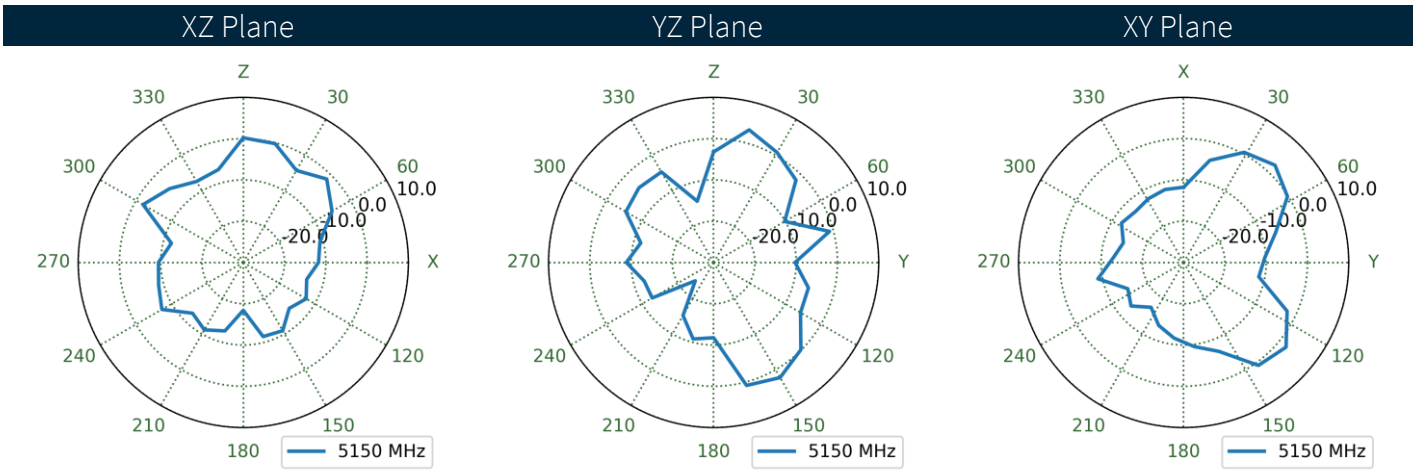
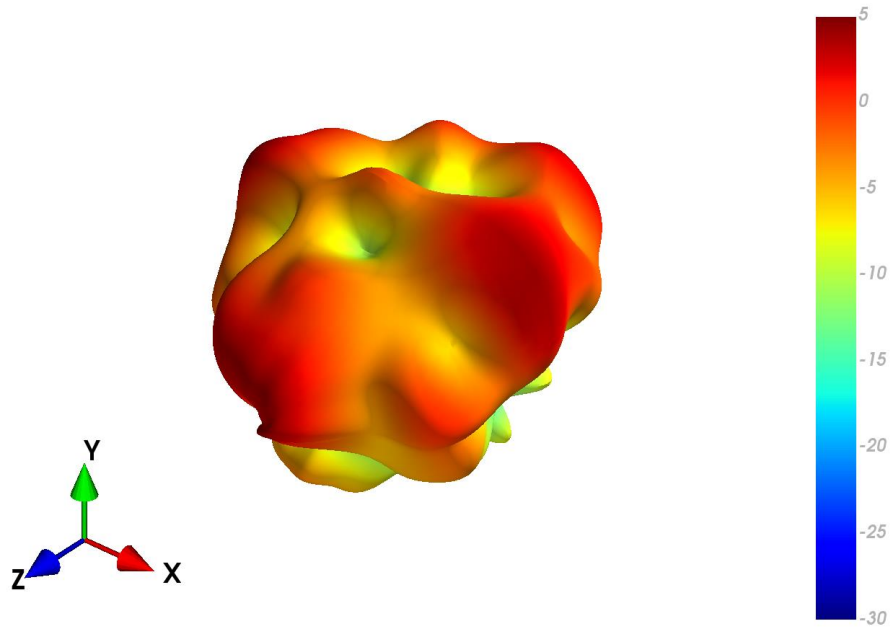

4.30 Free Space - Patterns at 5150 MHz

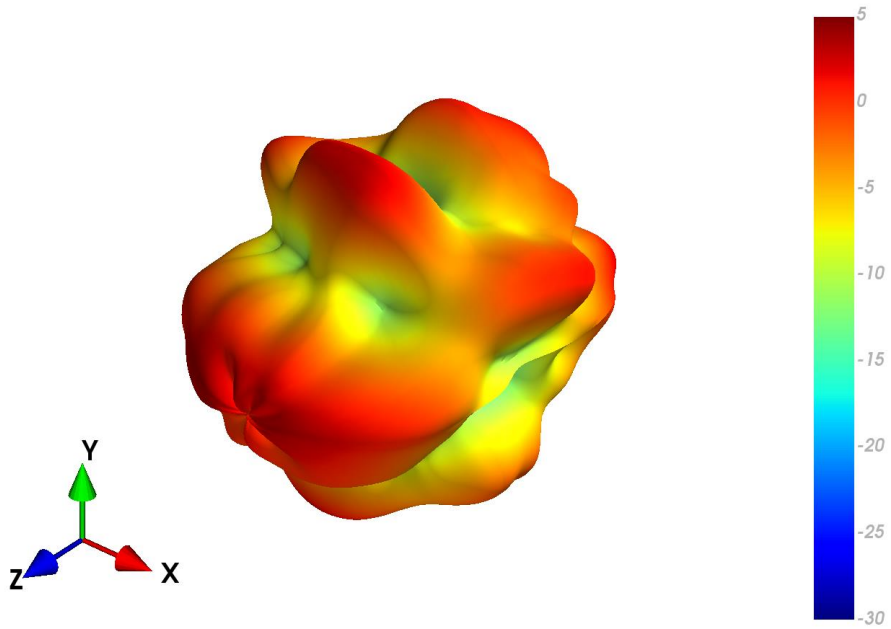

XZ Plane YZ Plane XY Plane

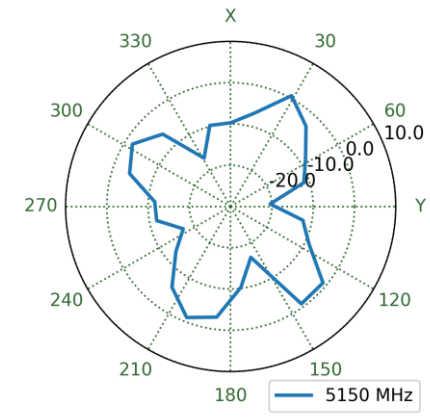
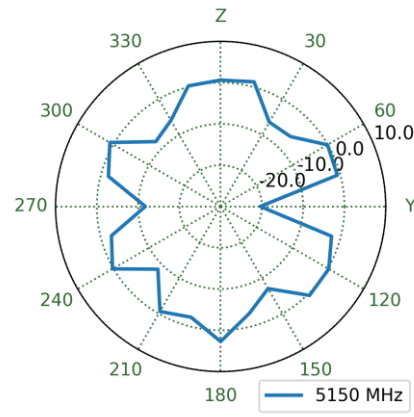
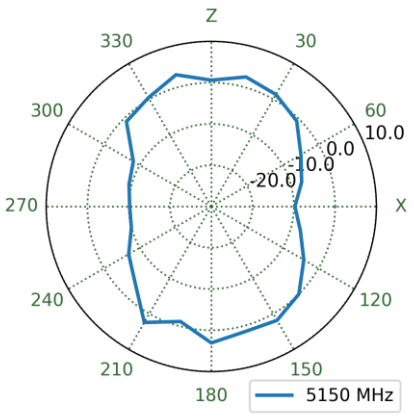

4.31 30x30cm Ground Plane (Edge) - Patterns at 5150 MHz

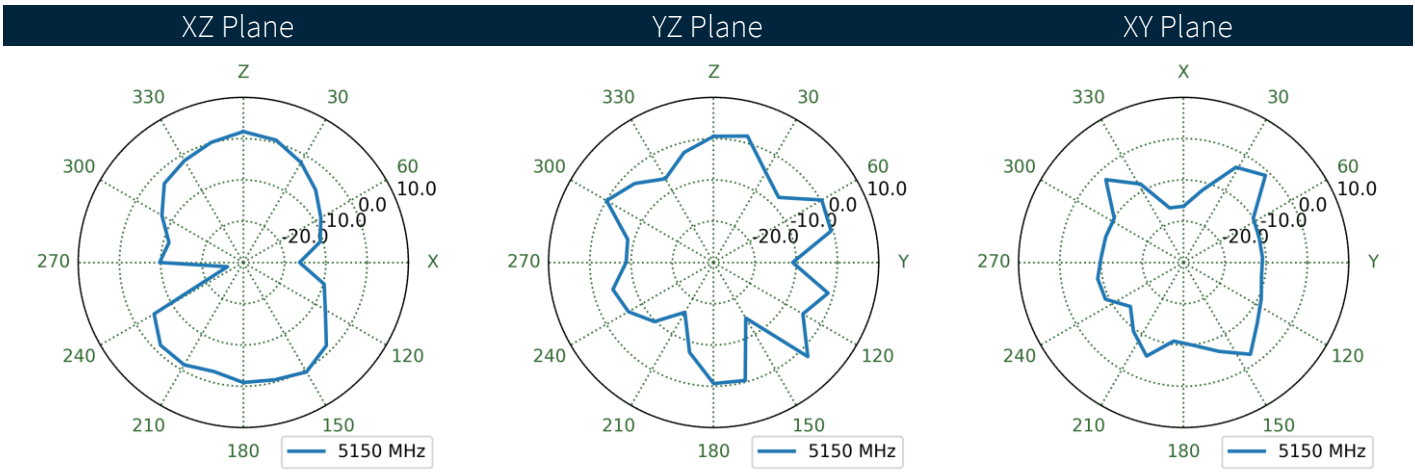
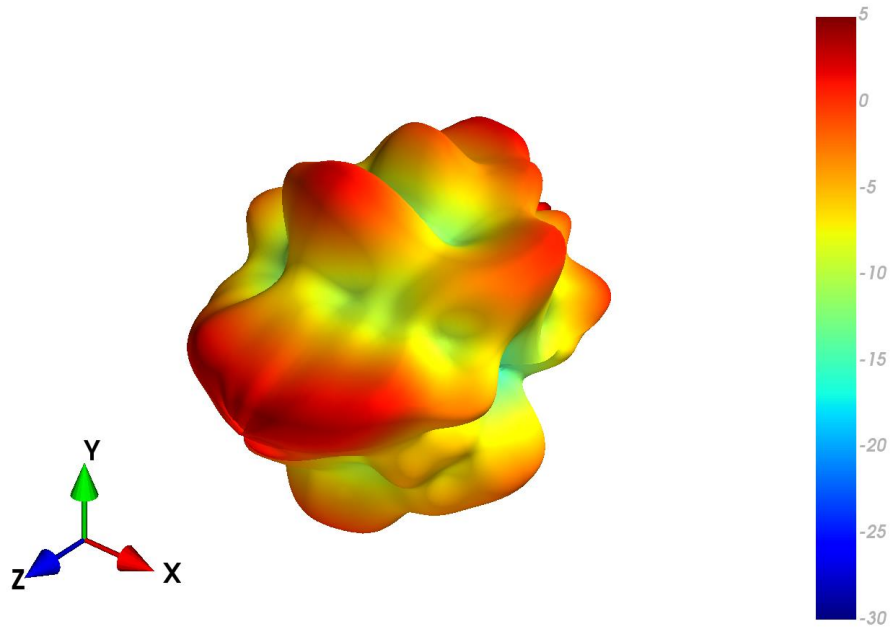

4.32 30x30cm Ground Plane (Centre) - Patterns at 5550 MHz

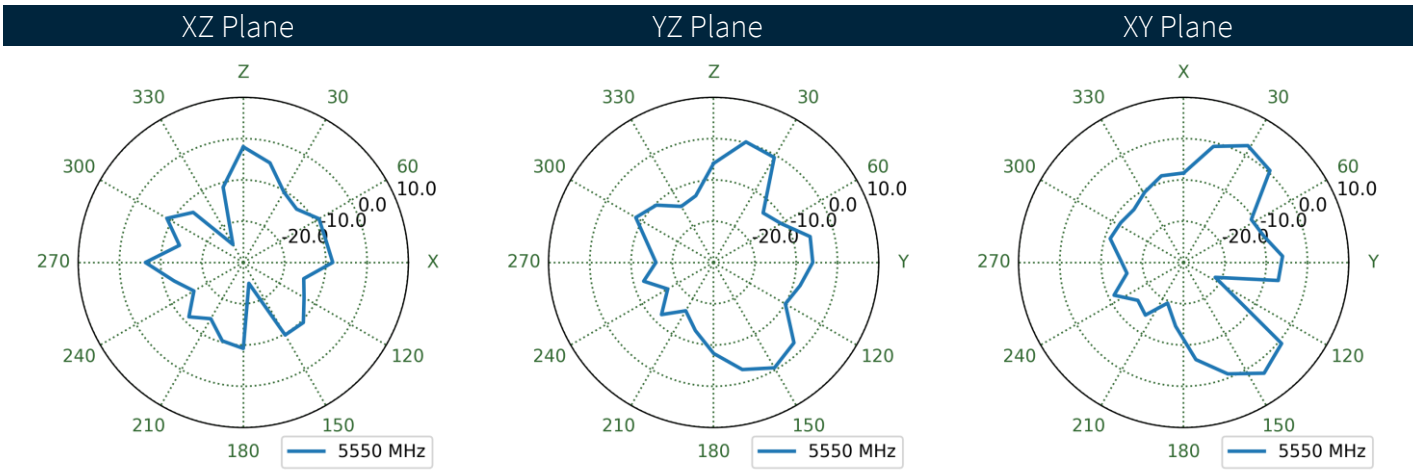
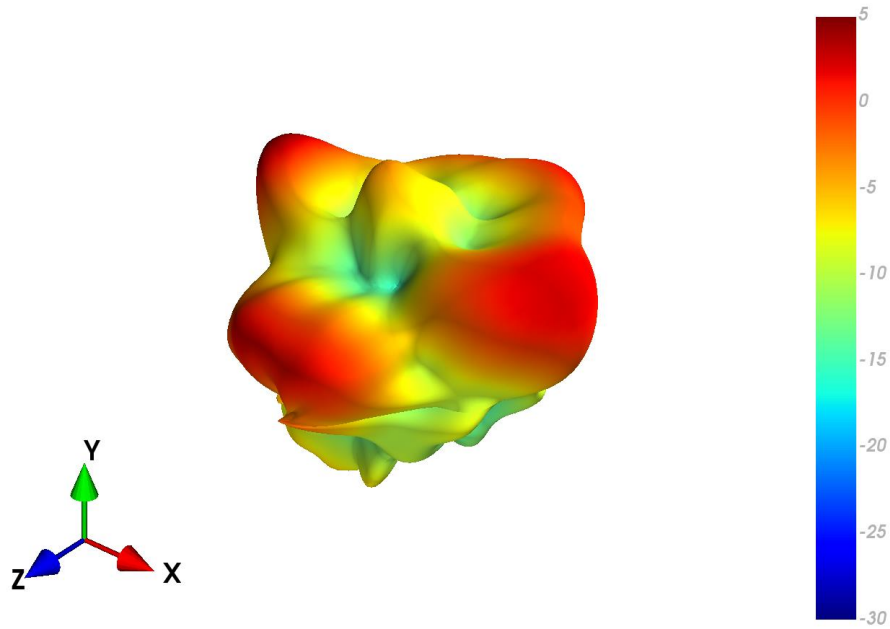

4.33 Free Space - Patterns at 5550 MHz

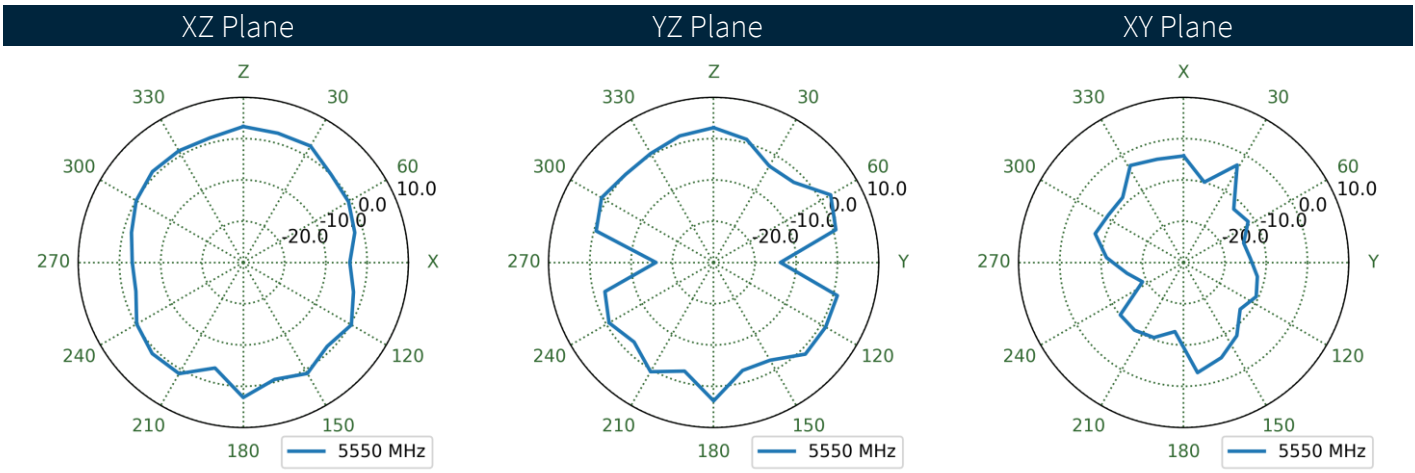
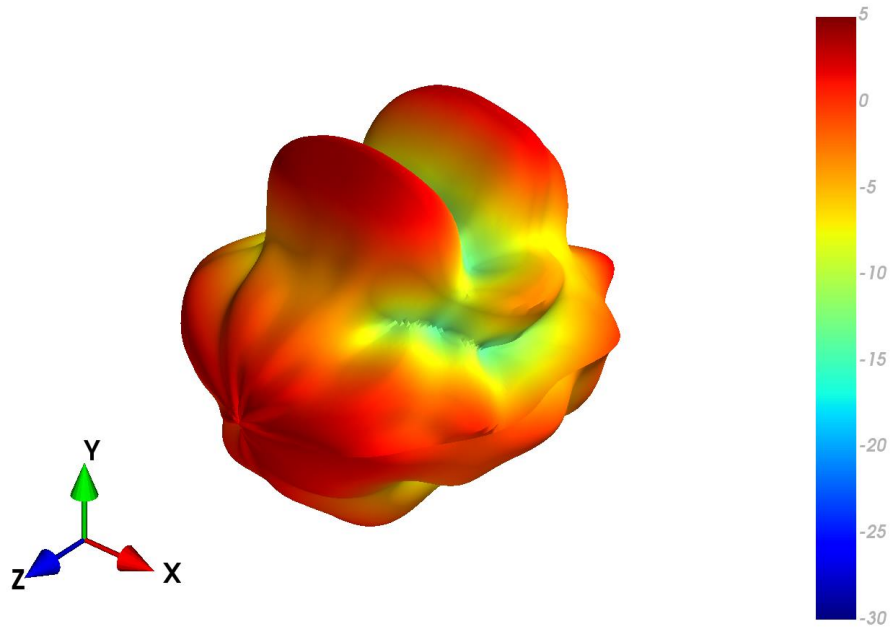

4.34 30x30cm Ground Plane (Edge) - Patterns at 5550 MHz

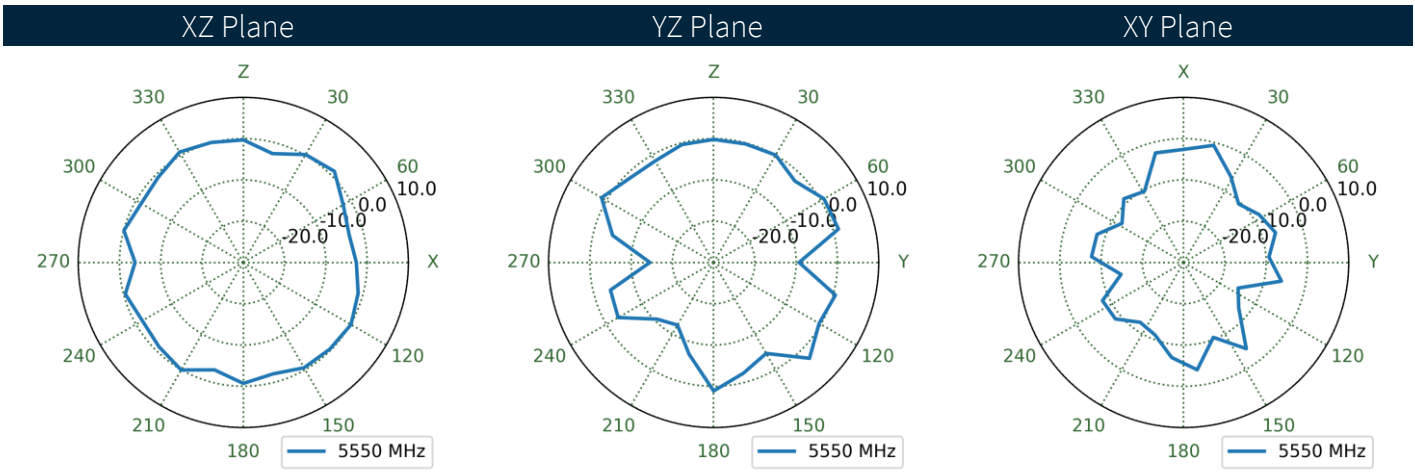
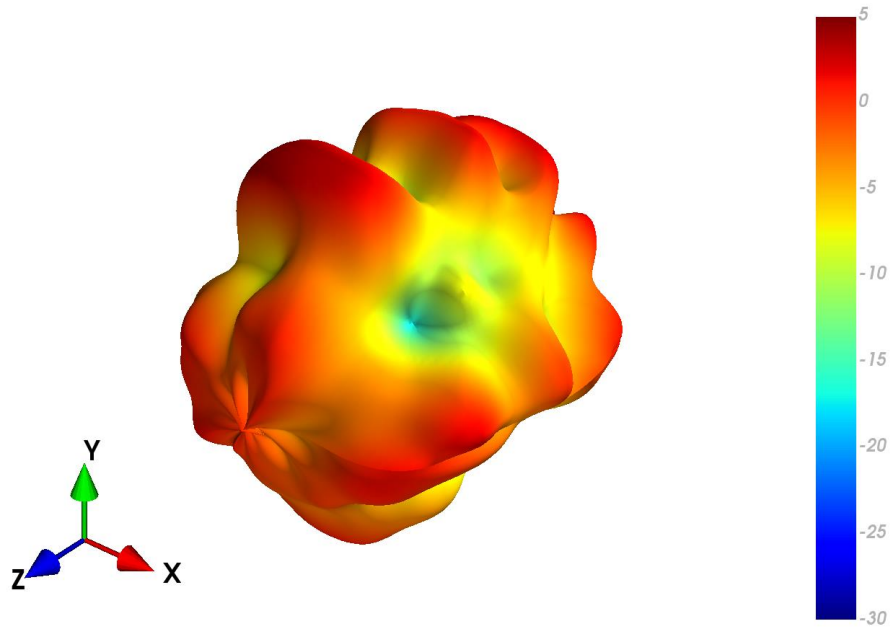

5. Mechanical Drawing

Front View

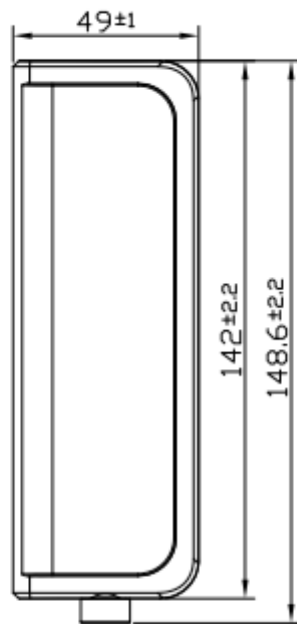

Side View

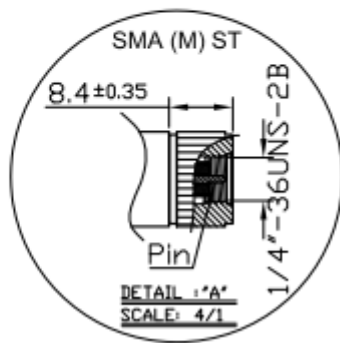
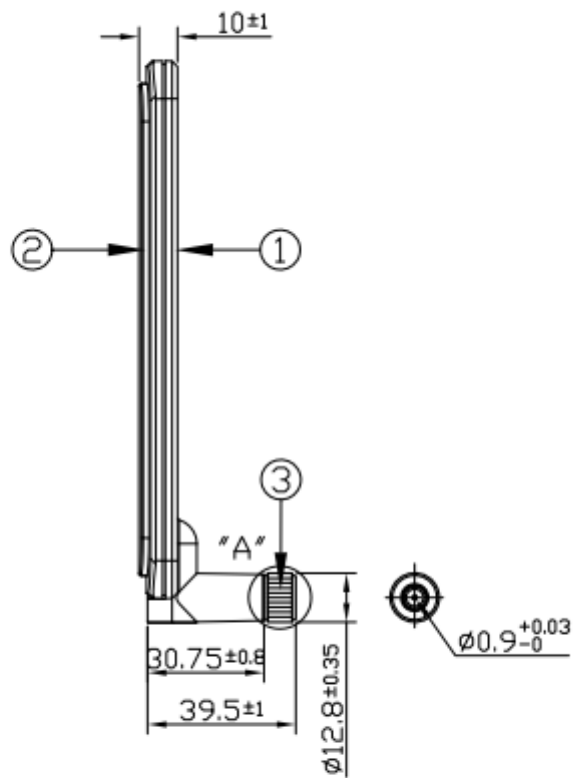

6. Packaging

1 pcs TG.30.8112 per PE Bag
 PE Bag Dimensions - 75*210mm
 Weight - 48g

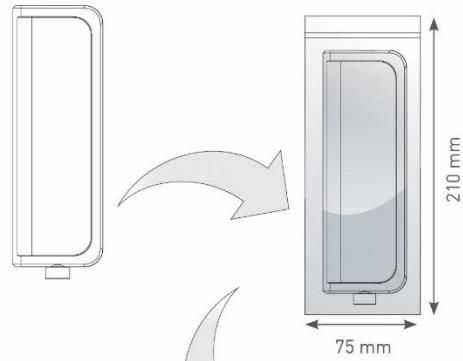

50 PE Bags per Large PE Bag
 50 pcs TG.30.8112 per Large PE Bag
 Large PE Dimensions - 360*520mm
 Weight - 2.4kg

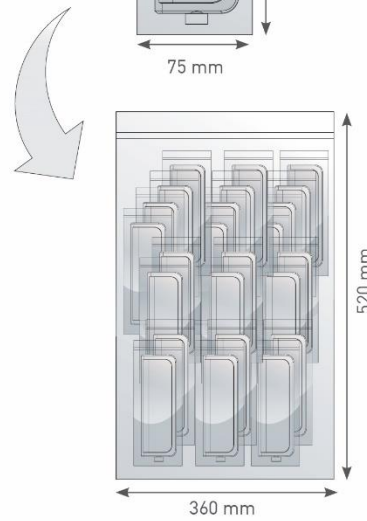

5 Large PE bags per carton
 250 pcs TG.30.8112 per carton
 Carton Dimensions - 430*380*280mm
 Weight - 12.4kg

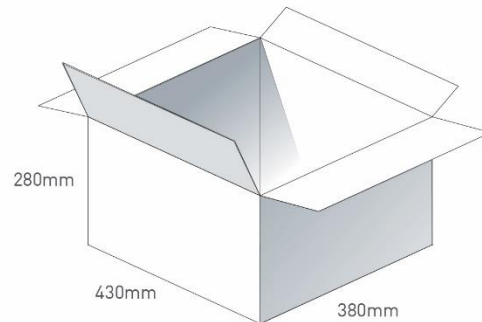

Pallet Dimensions 1200mm*1000mm*1320mm
 12 Cartons per Pallet
 6 Cartons per layer
 2 Layers

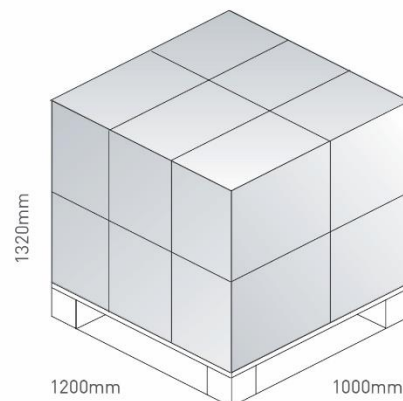

Changelog for the datasheet

SPE-12-8-120 - TG.30.8112

Revision: K (Current Version)

Date:	2023-01-24
Changes:	Adding dimensions to mechanical table
Changes Made by:	Cesar Sousa

Previous Revisions

Revision: J

Date:	2023-01-17
Changes:	Adding band 40 to spec table (full datasheet update)
Changes Made by:	Gary West

Revision: E

Date:	2015-03-30
Changes:	Updated Spec with LTE table
Changes Made by:	Andy Mahoney

Revision: I

Date:	2022-09-26
Changes:	Updated specifications
Changes Made by:	Cesar Sousa

Revision: D

Date:	2017-01-13
Changes:	
Changes Made by:	Technical Writer

Revision: H

Date:	2022-05-05
Changes:	Full datasheet template update and show data 600-6000.
Changes Made by:	Gary West

Revision: C

Date:	2012-10-04
Changes:	
Changes Made by:	Technical Writer

Revision: G

Date:	2021-07-09
Changes:	Added IP Rating
Changes Made by:	Gary West

Revision: B

Date:	2012-09-27
Changes:	
Changes Made by:	Technical Writer

Revision: F

Date:	2018-11-30
Changes:	Removed IP rating
Changes Made by:	Jack Conroy

Revision: A (Original First Release)

Date:	2012-09-19
Notes:	
Author:	Technical Writer

