



TAOGLAS®



Datasheet

Apex IV

Part No:
TG.46.8113

Description:

Apex IV Wideband 5G/4G Dipole Terminal Antenna 450MHz – 6GHz
with 90° Hinged SMA(M) Connector

Features:

Highest efficiency for 450-6000MHz wideband applications

Worldwide 5G/4G Coverage

Dipole Antenna Design – No Ground Plane Required

Hinged 90° Termination with SMA(M) Connector

Robust Metal Hinge Design for Improved Connection Reliability.

Dimensions: 218 * 58mm

RoHS & Reach Compliant

1. Introduction	3
2. Specifications	5
3. Antenna Characteristics	8
4. Radiation Patterns	11
5. Mechanical Drawing	32
6. Installation Recommendations	33
7. Packaging	34
<hr/>	
Changelog	35

Taoglas makes no warranties based on the accuracy or completeness of the contents of this document and reserves the right to make changes to specifications and product descriptions at any time without notice. Taoglas reserves all rights to this document and the information contained herein. Reproduction, use or disclosure to third parties without express permission is strictly prohibited.



1. Introduction



The Taoglas Apex IV TG.46.8113 is a wideband 5G/4G dipole antenna that has been designed to cover all sub 6GHz 5G/4G Cellular, ISM and Wi-Fi bands with frequencies in the 450 to 6000MHz spectrum. Evolved from the highly successful Apex range of products, the TG.46 has the highest wideband efficiency of any terminal antenna on the market today. Designed specifically for optimum performance on 5G NR bands between 3.3-4.2GHz, the TG.46 exhibits a uniform omnidirectional radiation pattern that allows for truly uninterrupted 360° 5G connection reliability. Additionally, the extended lower frequency coverage at 450MHZ (Band 31), makes the TG.46 ideal for a range of IoT applications, such as remote monitoring of smart utilities.

This attractive slim-line antenna is ground plane independent, meaning it does not need to be connected to the ground-plane of a device to radiate efficiently and neither is it in any way detuned by connecting to a ground-plane, thus avoiding a problem that is synonymous with smaller terminal mount antennas. The TG.46 includes an SMA(M) connector as standard, and the swivel mechanism that allows the antenna to be rotated to fit in tight environments and positioned for optimum performance. The 90° metal hinge structure has been designed so that when the antenna is mounted in a 90° position, it retains its position if used in environments prone to vibration.

The Apex IV has been primarily designed for use with wideband 5G/4G modules and devices that require the highest possible efficiency and peak gain to deliver best in class throughput on all major worldwide cellular bands for access points, terminals and routers. High efficiency is vital for applications

such as high speed video and real-time streaming or high capacity MIMO networks on public transportation. The Apex IV is backward compatible with 3G and 2G cellular applications such as HSPA, GSM, GPRS, UMTS, Wi-Fi and even has GPS included for Assisted GPS and/or E911 applications.

In summary, the Apex IV is the ideal solution for any device requiring high, reliable performance. It will meet most types of approval or carrier certification requirements from an efficiency standpoint. The antenna also makes an excellent reference antenna for test purposes. It has been designed as an omnidirectional antenna and the radiation patterns prove this, being stable across all bands. The connector type is customizable and the housing is also available in white. Contact your regional Taoglas customer support team for more information.



2. Specifications

Electrical									
Band	Frequency (MHz)		Efficiency (%)	Average Gain (dB)	Peak Gain (dBi)	Impedance	Max Input Power	Polarization	Radiation Pattern
4G/3G Band 31	430~470	Straight FS	53.0	-2.76	0.79	50 Ω	10W	Linear	Omni-Directional
		Bent FS	47.2	-3.26	1.26				
		Straight GP	60.5	-2.18	1.49				
		Bent GP	44.7	-3.50	0.08				
5GNR/4G Band 71	617~698	Straight FS	63.7	-1.96	1.70				
		Bent FS	76.2	-1.18	2.19				
		Straight GP	64.9	-1.87	2.21				
		Bent GP	71.0	-1.49	1.90				
4G/3G Band 12,13,14,17,28,29	698~806	Straight FS	50.0	-3.01	1.70				
		Bent FS	55.9	-2.53	2.12				
		Straight GP	48.4	-3.15	1.97				
		Bent GP	50.5	-2.96	1.26				
4G/3G/NB-IoT/Cat M Band 5,8,18,19,20,26,27	824~960	Straight FS	36.7	-4.35	1.76				
		Bent FS	49.8	-3.03	2.57				
		Straight GP	50.1	-3.01	3.12				
		Bent GP	57.0	-2.44	3.87				
5GNR/4G Band 21,32,74,75,76	1427~1518	Straight FS	69.1	-1.60	2.11				
		Bent FS	77.9	-1.09	3.15				
		Straight GP	66.6	-1.77	2.31				
		Bent GP	66.7	-1.76	2.84				
4G/3G Band 1,2,3,4,9,23,25,35,39,66	1710~2200	Straight FS	79.6	-0.99	3.98				
		Bent FS	87.3	-0.59	4.90				
		Straight GP	75.1	-1.24	3.67				
		Bent GP	76.0	-1.19	4.43				
4G/3G Band 7,30,38,40,41	2300~2690	Straight FS	69.9	-1.55	3.77				
		Bent FS	77.9	-1.09	5.05				
		Straight GP	64.7	-1.89	4.24				
		Bent GP	66.1	-1.80	4.34				
5GNR/4G Band 22,42,48,77,78,79	3300~4200	Straight FS	52.0	-2.84	4.36				
		Bent FS	58.2	-2.35	4.52				
		Straight GP	48.2	-3.17	3.70				
		Bent GP	47.1	-3.27	4.20				
LTE5200/ Wi-Fi 5800	5150~5925	Straight FS	56.7	-2.46	3.92				
		Bent FS	61.1	-2.14	4.45				
		Straight GP	41.1	-3.86	4.29				
		Bent GP	40.8	-3.90	4.64				

*Test ground plane size: 150*90mm

Mechanical

Enclosure	UV Resistant PC/ABS
Connector	SMA Male Hinged 90°
Weight	75g
Dimensions	218 * 58mm
Recommended Torque for Mounting	0.9N·m
Max torque for Mounting	1.176N·m

Environmental

Storage & Usage Temperature Range	-40°C to 85°C
Humidity	Non-condensing 65°C 95% RH

5G/4G Bands			
Band Number	5G NR / FR1 / LTE / LTE-Advanced / WCDMA / HSPA / HSPA+ / TD-SCDMA		
	Uplink	Downlink	Covered
1	UL: 1920 to 1980	DL: 2110 to 2170	✓
2	UL: 1850 to 1910	DL: 1930 to 1990	✓
3	UL: 1710 to 1785	DL: 1805 to 1880	✓
4	UL: 1710 to 1755	DL: 2110 to 2155	✓
5	UL: 824 to 849	DL: 869 to 894	✓
7	UL: 2500 to 2570	DL: 2620 to 2690	✓
8	UL: 880 to 915	DL: 925 to 960	✓
9	UL: 1749.9 to 1784.9	DL: 1844.9 to 1879.9	✓
11	UL: 1427.9 to 1447.9	DL: 1475.9 to 1495.9	✓
12	UL: 699 to 716	DL: 729 to 746	✓
13	UL: 777 to 787	DL: 746 to 756	✓
14	UL: 788 to 798	DL: 758 to 768	✓
17	UL: 704 to 716	DL: 734 to 746	✓
18	UL: 815 to 830	DL: 860 to 875	✓
19	UL: 830 to 845	DL: 875 to 890	✓
20	UL: 832 to 862	DL: 791 to 821	✓
21	UL: 1447.9 to 1462.9	DL: 1495.9 to 1510.9	✓
22	UL: 3410 to 3490	DL: 3510 to 3590	✓
23	UL: 2000 to 2020	DL: 2180 to 2200	✓
24	UL: 1625.5 to 1660.5	DL: 1525 to 1559	✓
25	UL: 1850 to 1915	DL: 1930 to 1995	✓
26	UL: 814 to 849	DL: 859 to 894	✓
27	UL: 807 to 824	DL: 852 to 869	✓
28	UL: 703 to 748	DL: 758 to 803	✓
29	UL: -	DL: 717 to 728	✓
30	UL: 2305 to 2315	DL: 2350 to 2360	✓
31	UL: 452.5 to 457.5	DL: 462.5 to 467.5	✓
32	UL: -	DL: 1452 - 1496	✓
35		1850 to 1910	✓
38		2570 to 2620	✓
39		1880 to 1920	✓
40		2300 to 2400	✓
41		2496 to 2690	✓
42		3400 to 3600	✓
43		3600 to 3800	✓
48		3550 to 3700	✓
66	UL: 1710-1780	DL: 2110-2200	✓
71		617 to 698	✓
74/75/76		1427 to 1518	✓
77		3300 to 4200	✓
78		3300 to 3800	✓
79		4400 to 5000	✓

3. Antenna Characteristics

3.1 Return Loss

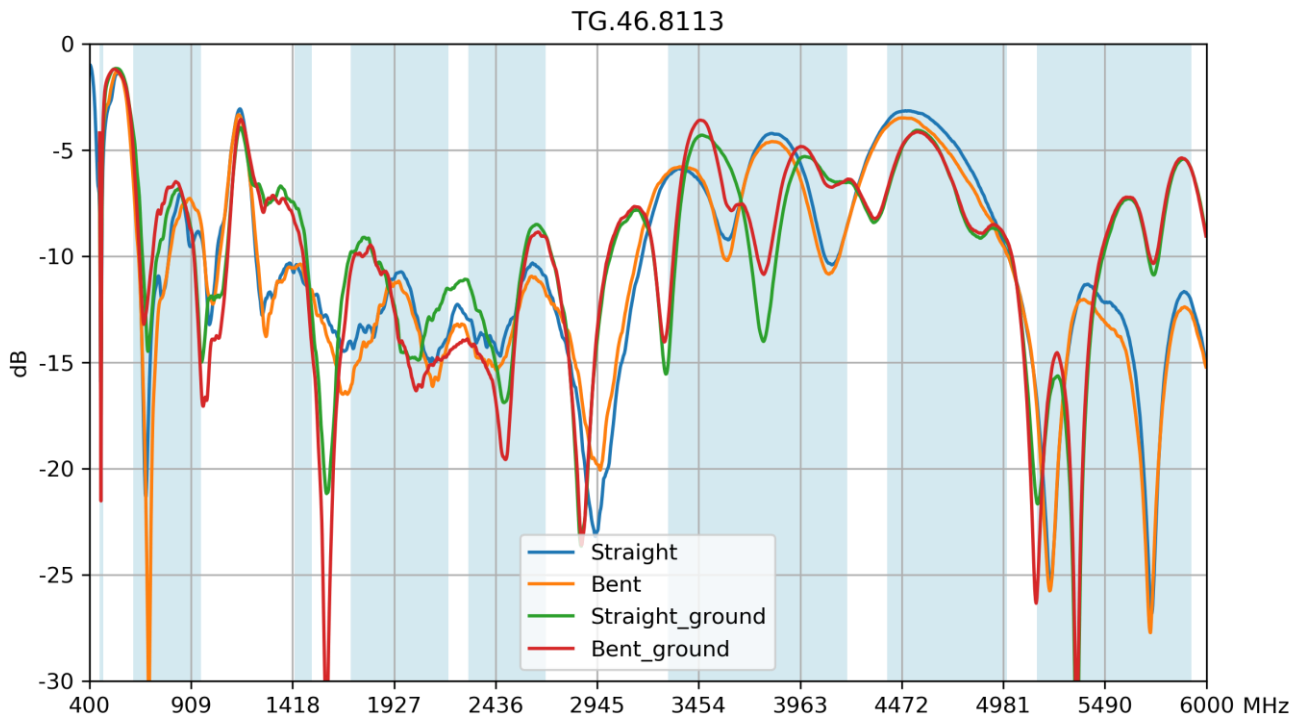

3.2 VSWR

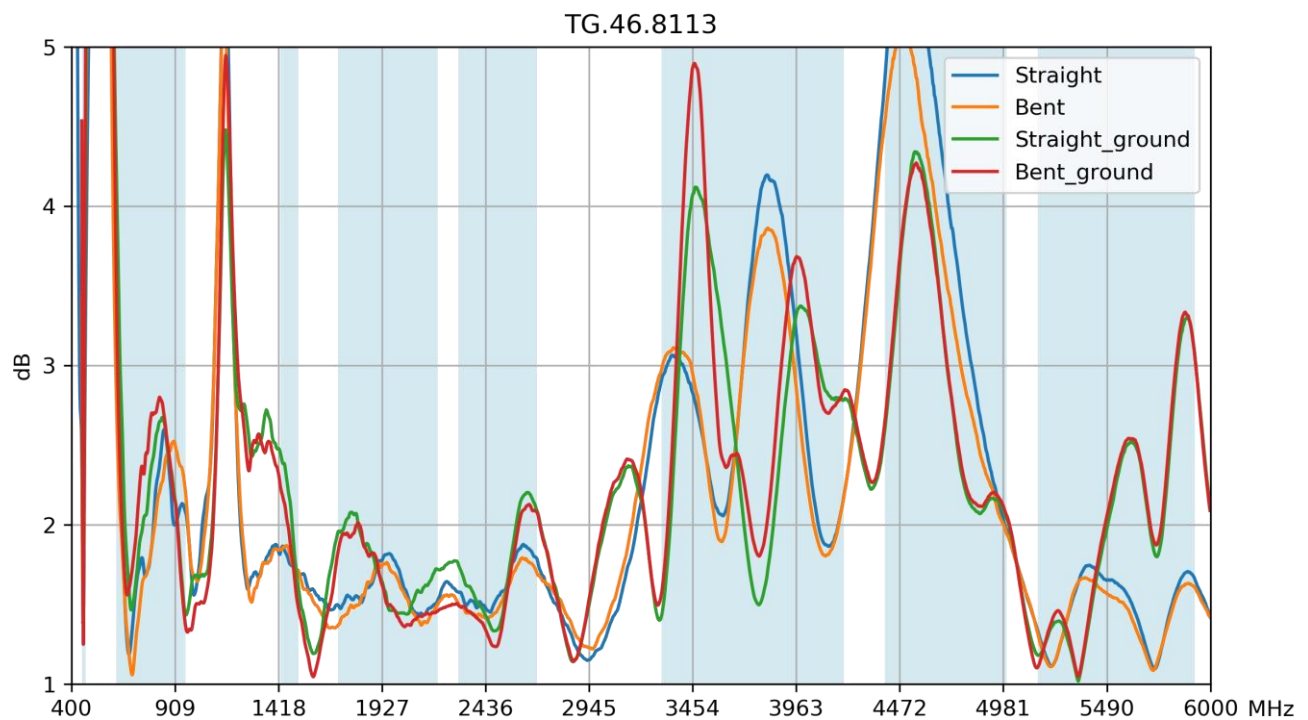

3.3 Efficiency

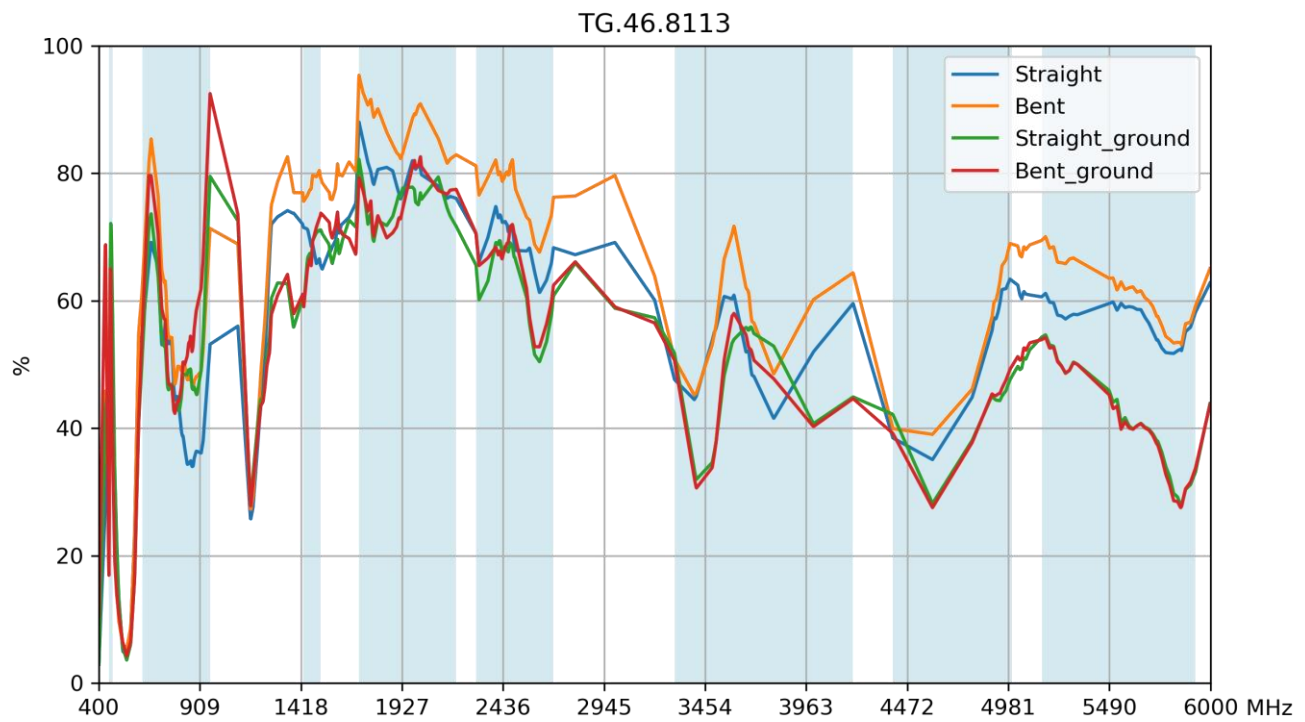

3.4 Peak Gain

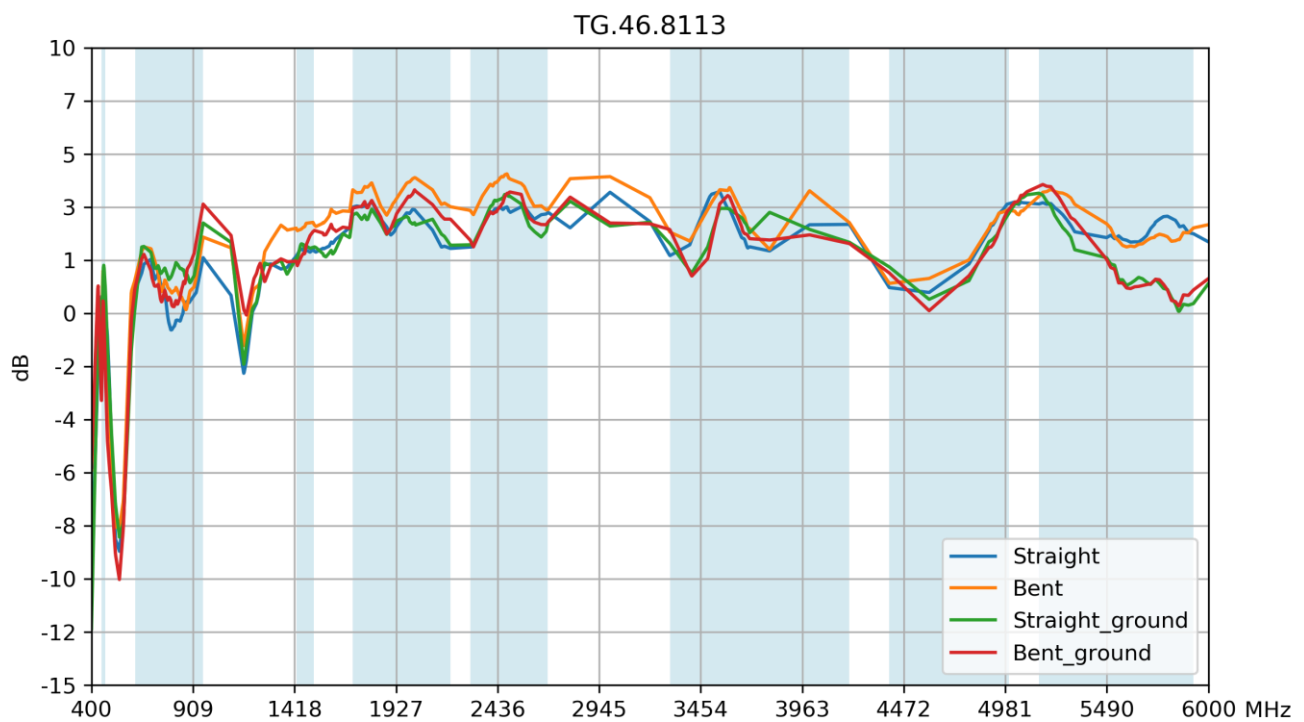

3.5 Average Gain

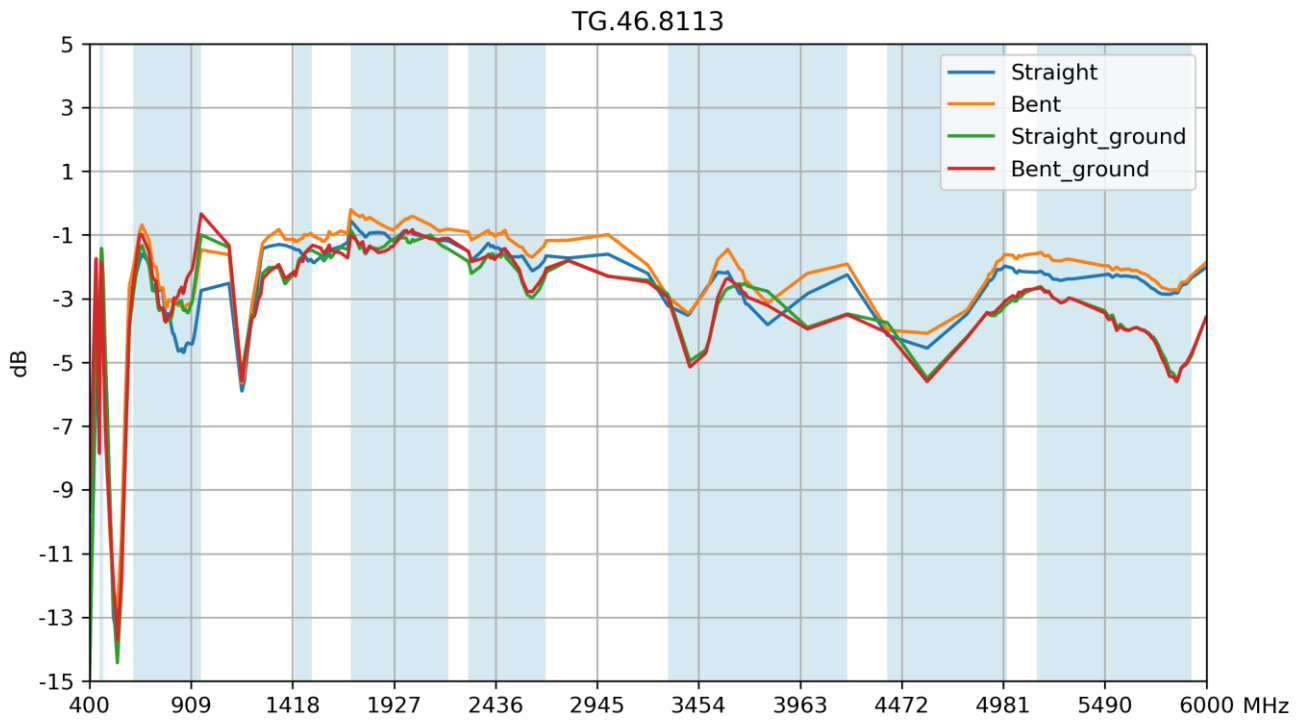

4. Radiation Patterns

4.1 Test Setup



Straight



Bent

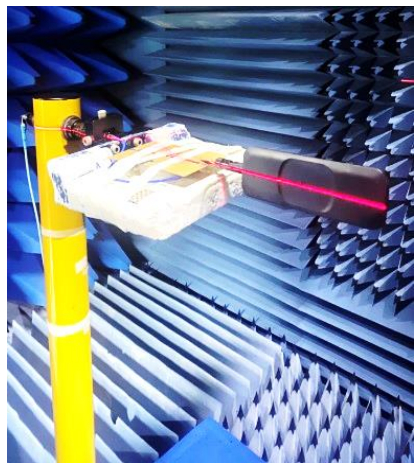
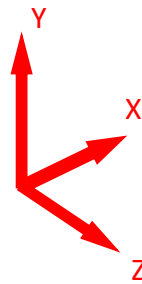

Straight with 90mm*150mm ground

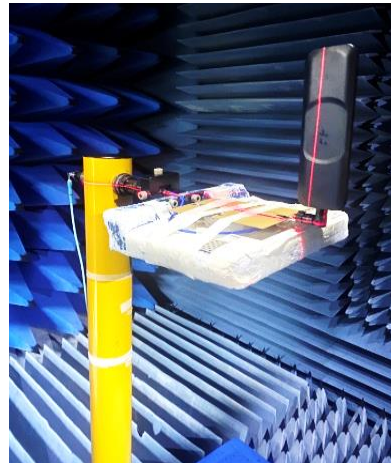

Bent with 90mm*150mm ground

4.2 3D and 2D Radiation Patterns - Straight

450MHz

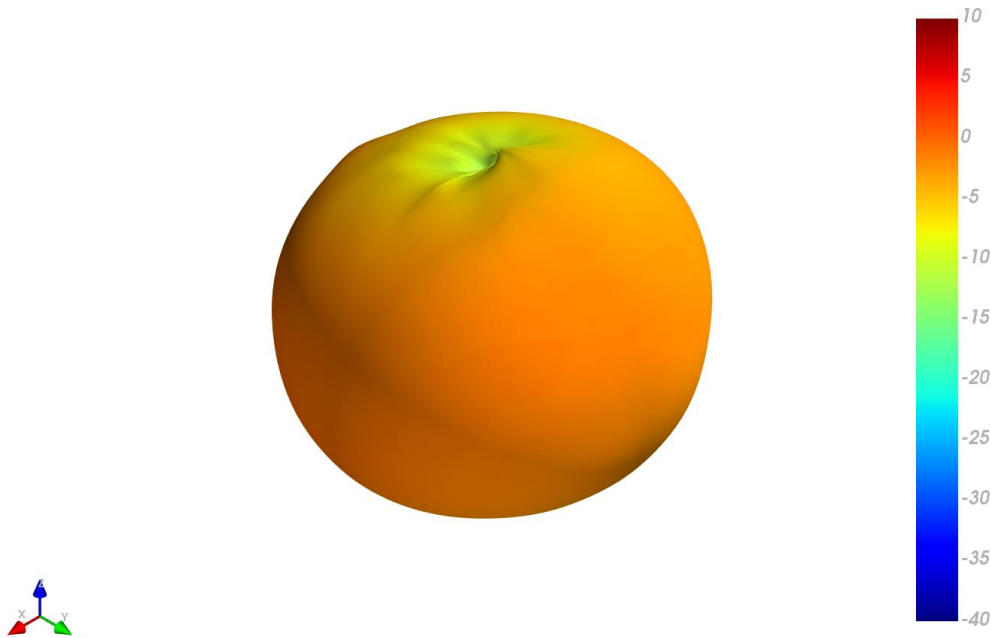

XY Plane

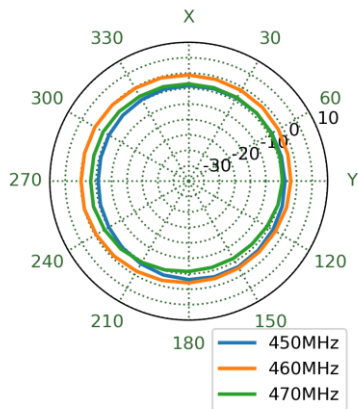

XZ Plane

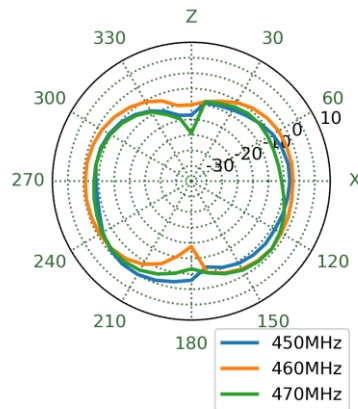

YZ Plane

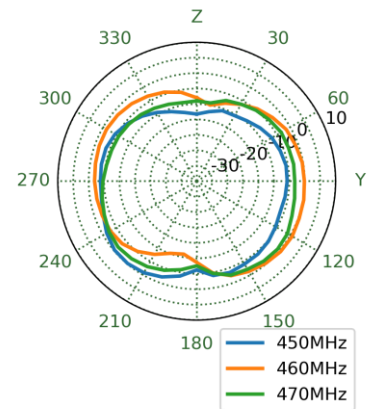

751MHz

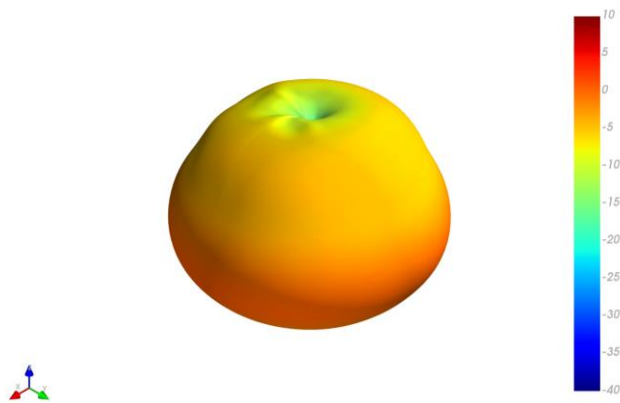

XY Plane

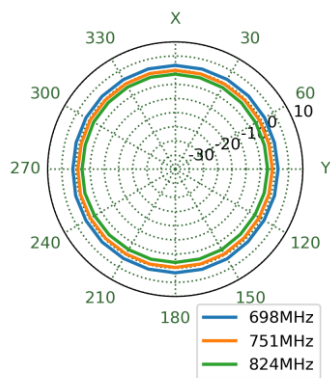

XZ Plane

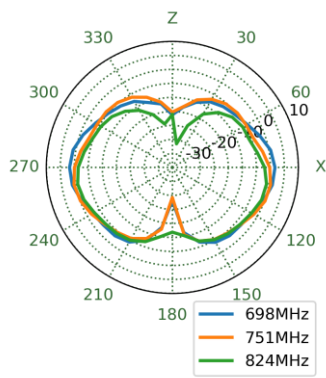

YZ Plane

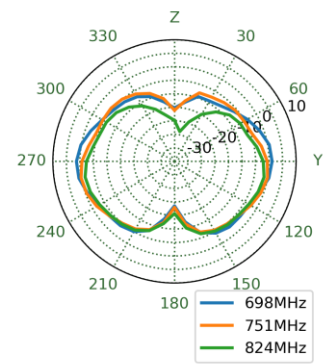

880MHz

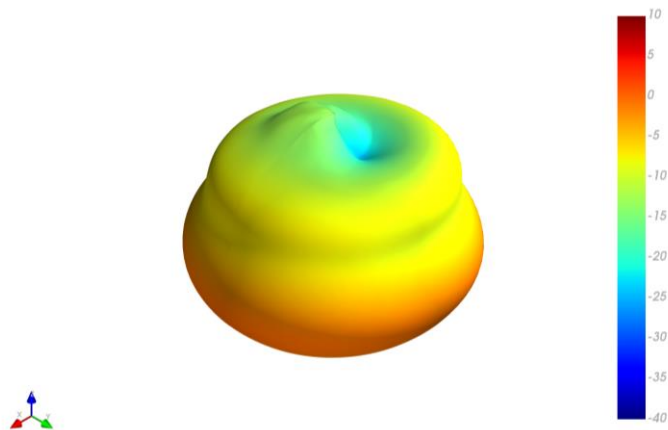

XY Plane

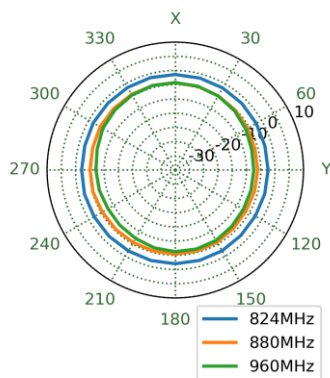

XZ Plane

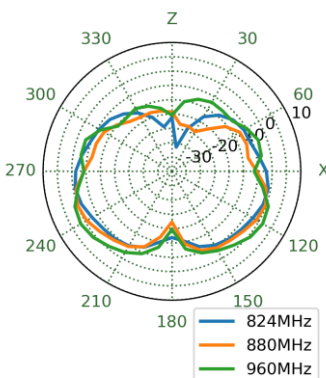

YZ Plane

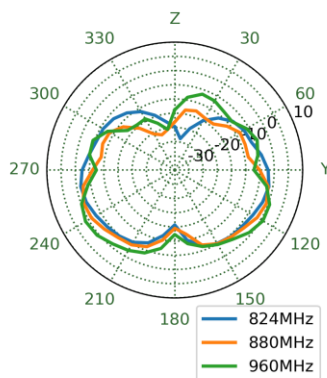

1930MHz

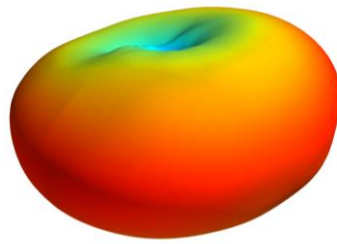

XY Plane

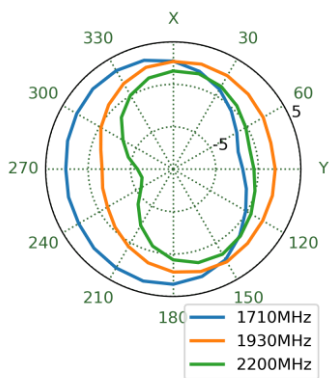

XZ Plane

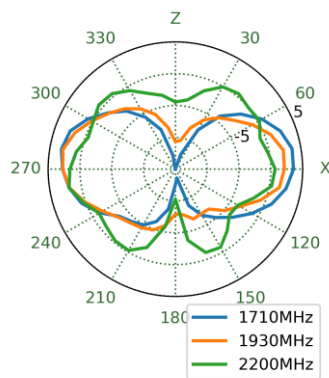

YZ Plane

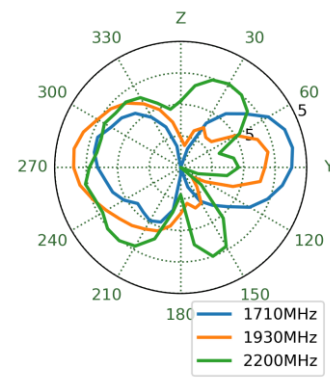

2496MHz

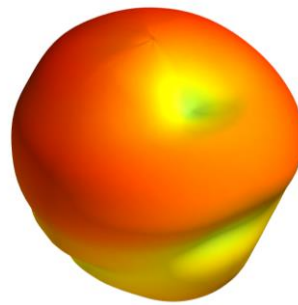

XY Plane

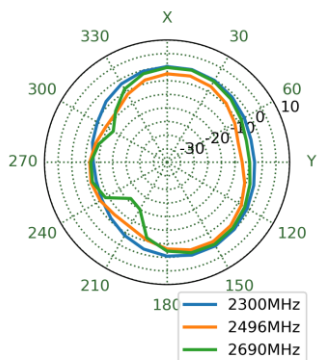

XZ Plane

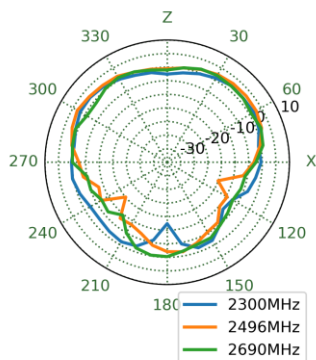

YZ Plane

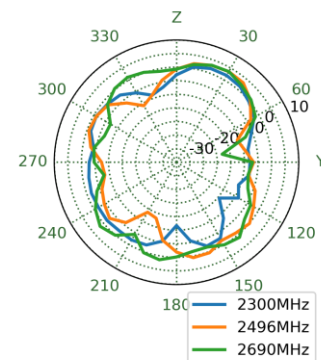

3550MHz

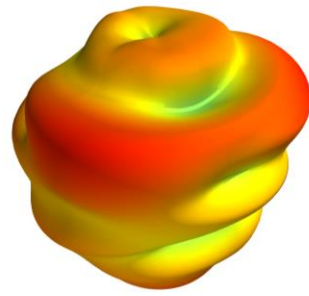

XY Plane

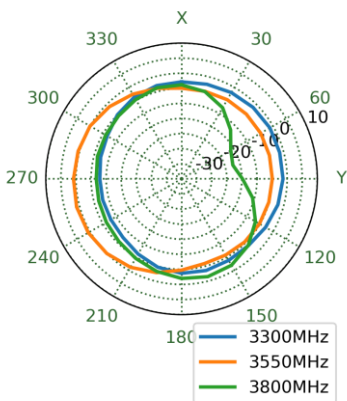

XZ Plane

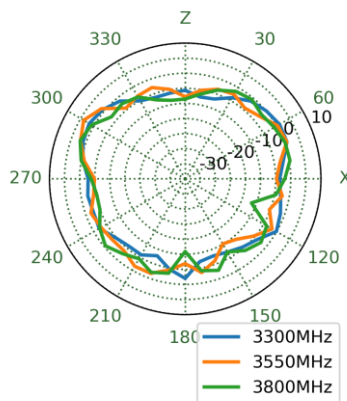

YZ Plane

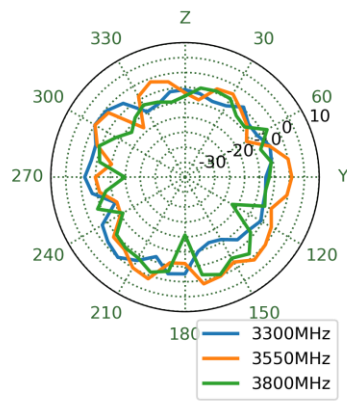

3700MHz

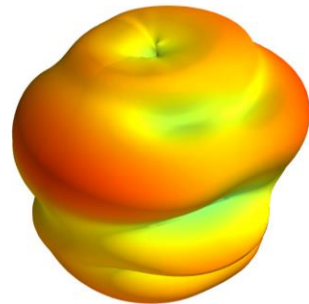

XY Plane

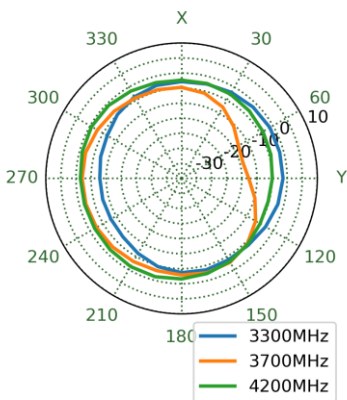

XZ Plane

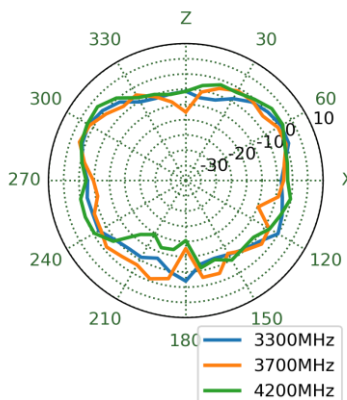

YZ Plane

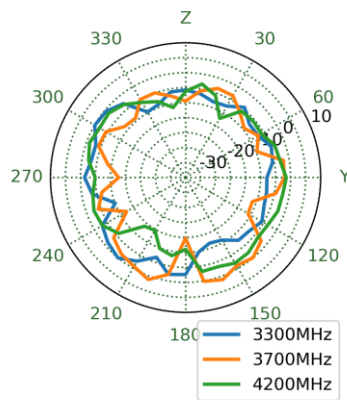

4800MHz

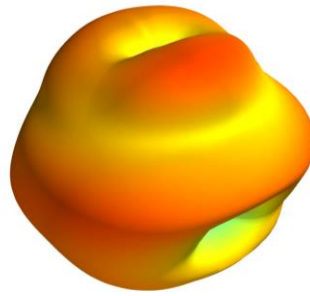

XY Plane

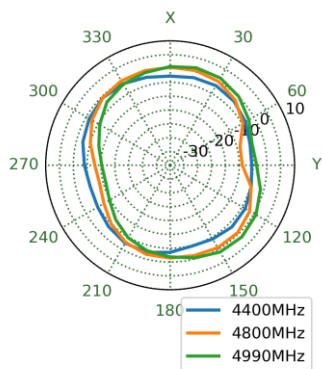

XZ Plane

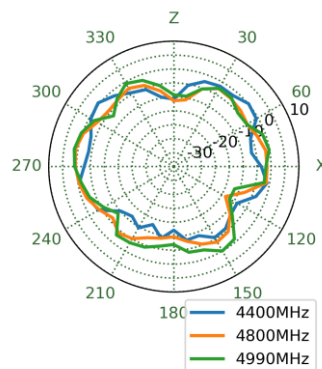

YZ Plane

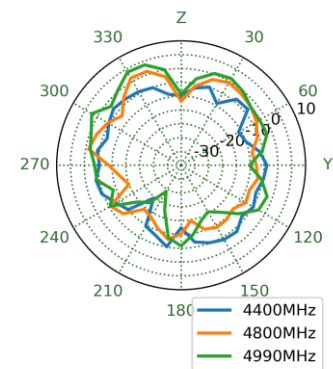

5550MHz

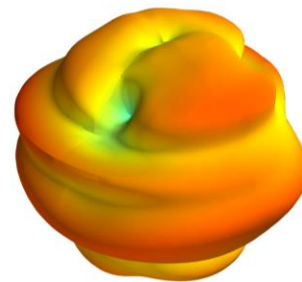

XY Plane

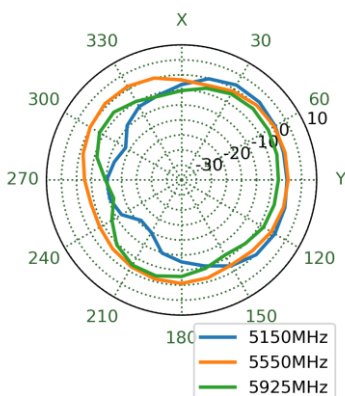

XZ Plane

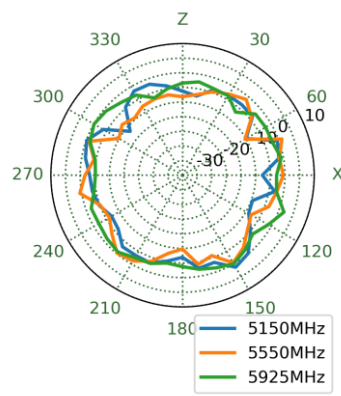

YZ Plane

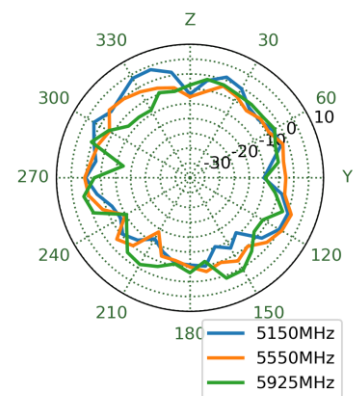

4.3 3D and 2D Radiation Patterns - Bent

450MHz

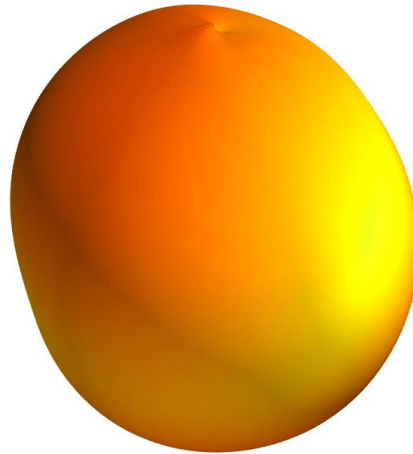

XY Plane

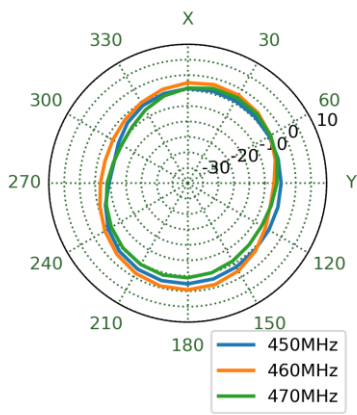

XZ Plane

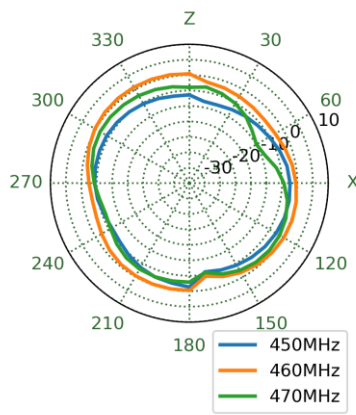

YZ Plane

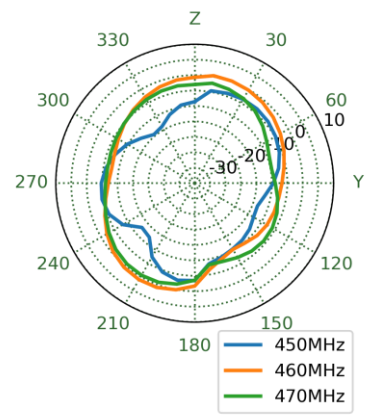

751MHz

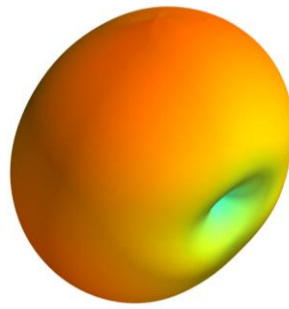

XY Plane

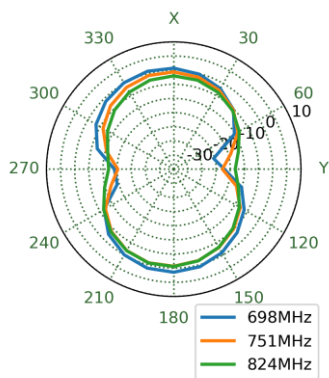

XZ Plane

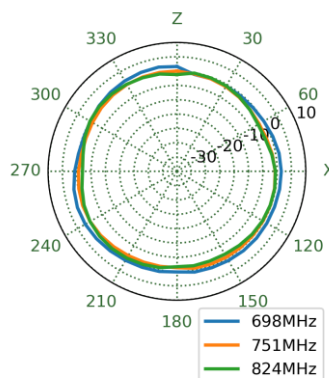

YZ Plane

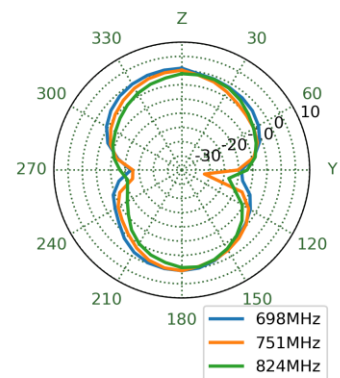

880MHz

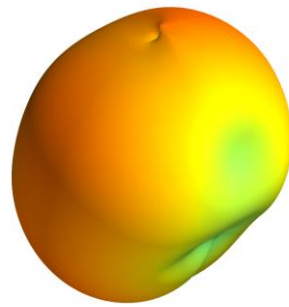

XY Plane

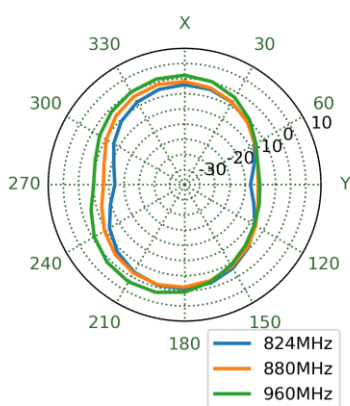

XZ Plane

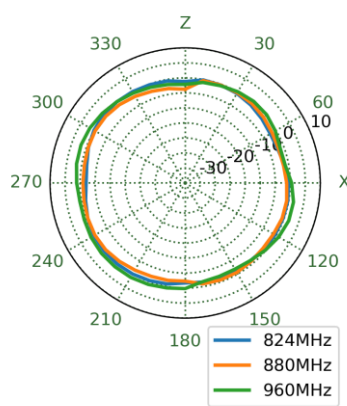

YZ Plane

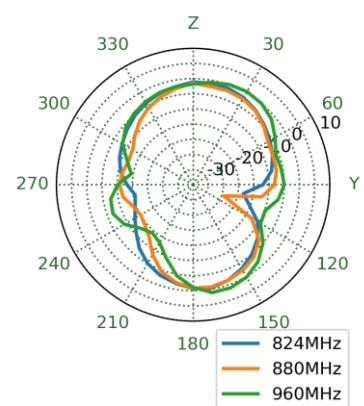

1930MHz

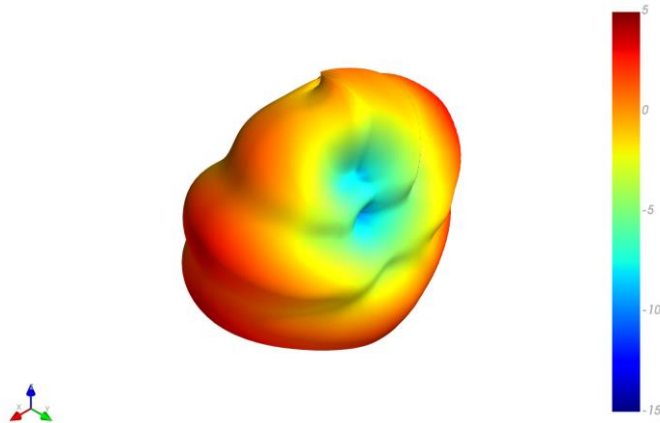

XY Plane

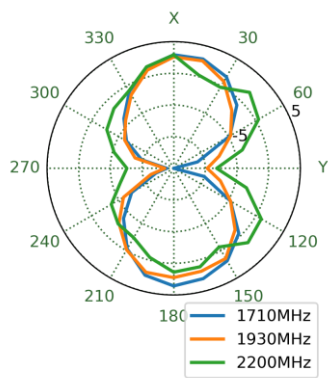

XZ Plane

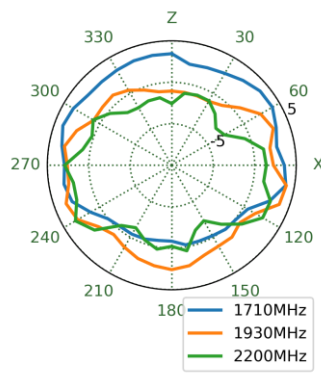

YZ Plane

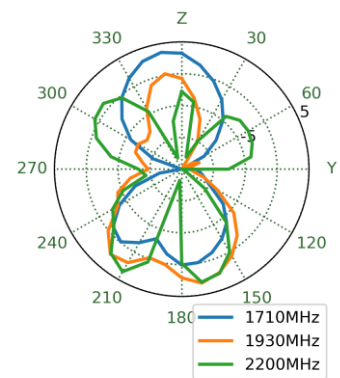

2496MHz

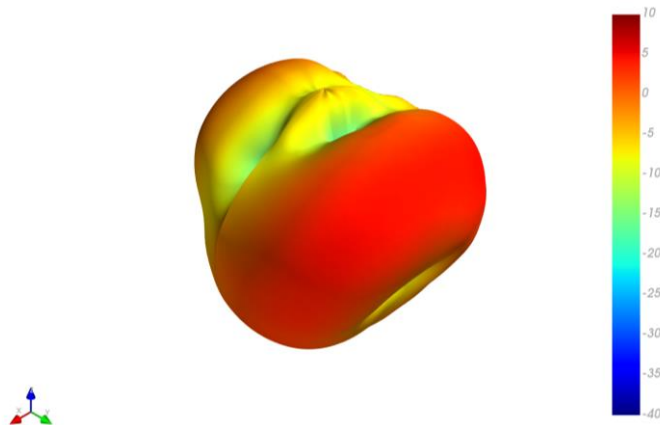

XY Plane

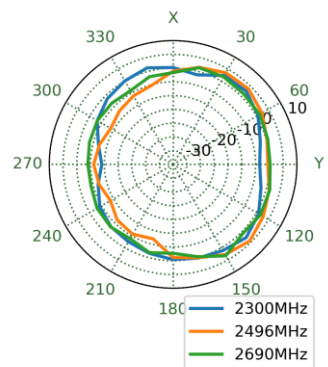

XZ Plane

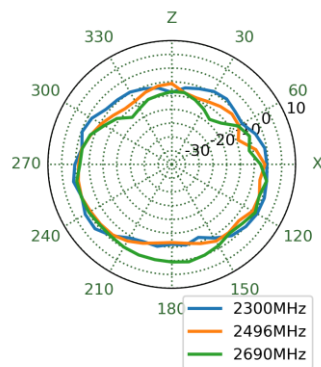

YZ Plane

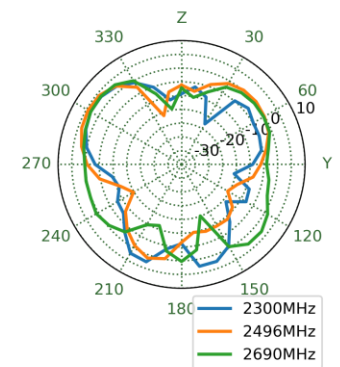

3550MHz

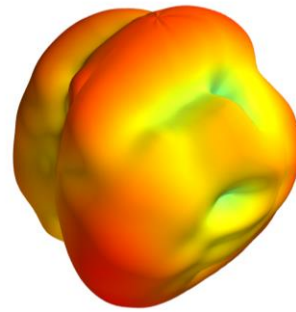

XY Plane

XZ Plane

YZ Plane

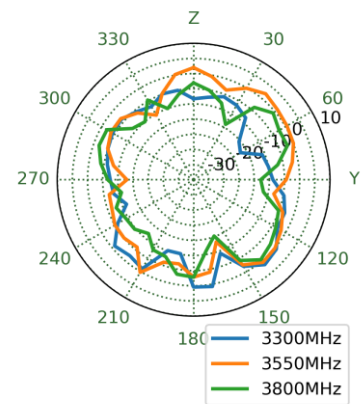
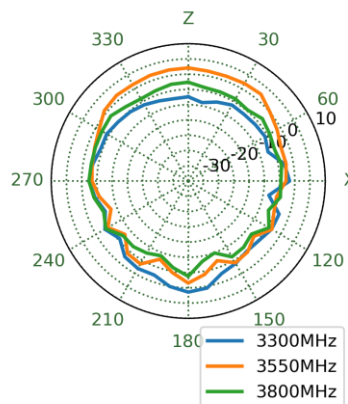
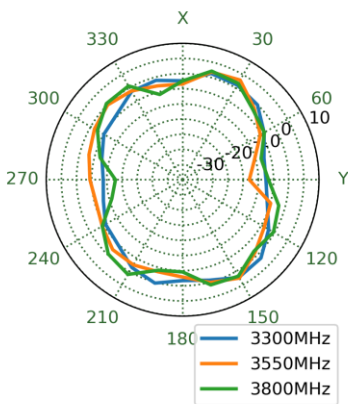

3700MHz

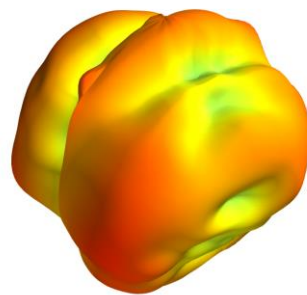

XY Plane

XZ Plane

YZ Plane

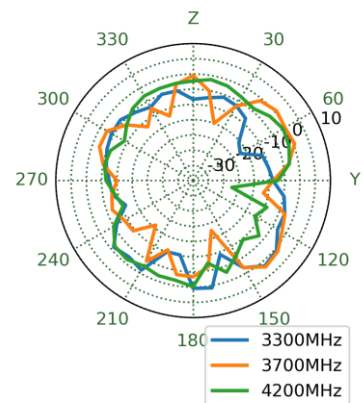
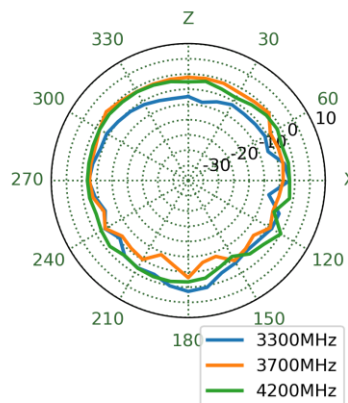
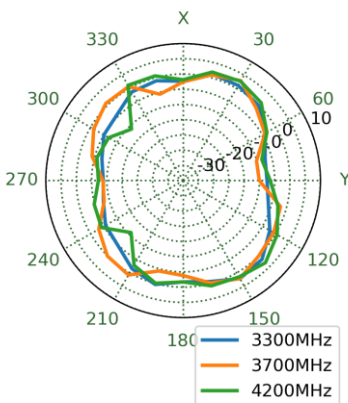

4800MHz

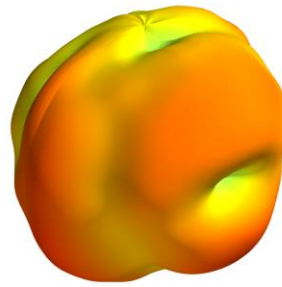

XY Plane

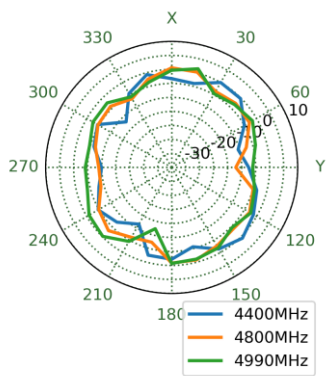

XZ Plane

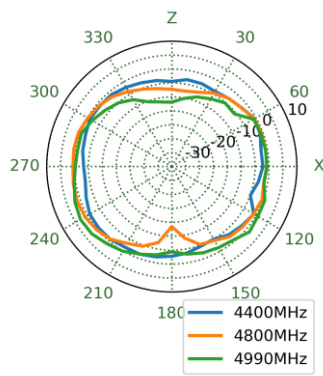

YZ Plane

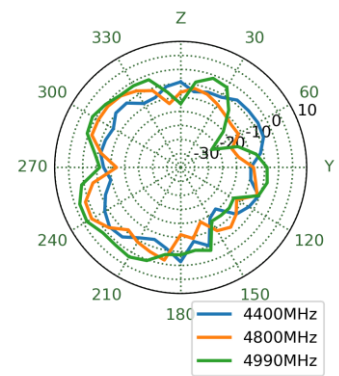

5550MHz

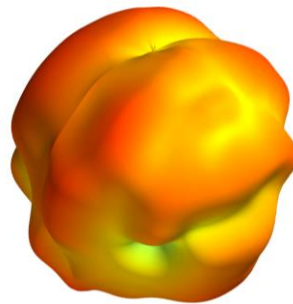

XY Plane

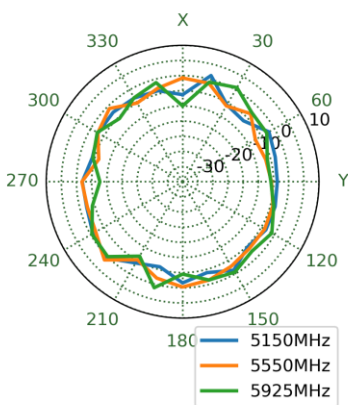

XZ Plane

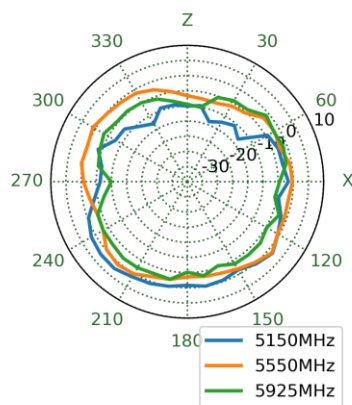

YZ Plane

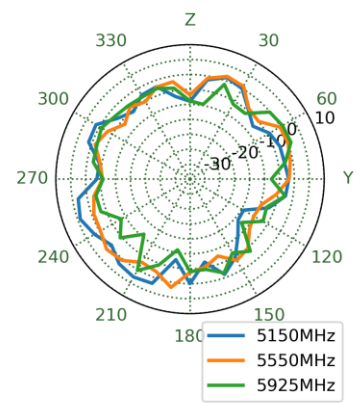

4.4 3D and 2D Radiation Patterns – Straight 150*90mm Ground Plane

450MHz

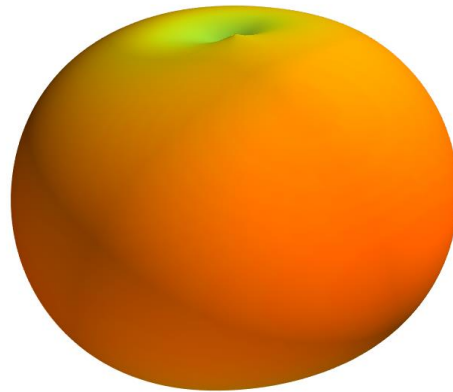

XY Plane

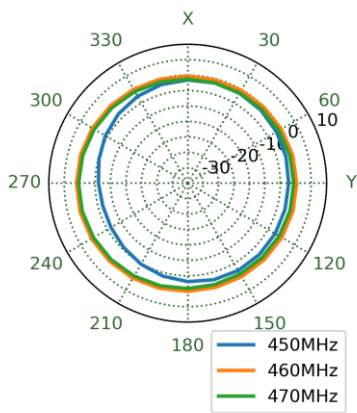

XZ Plane

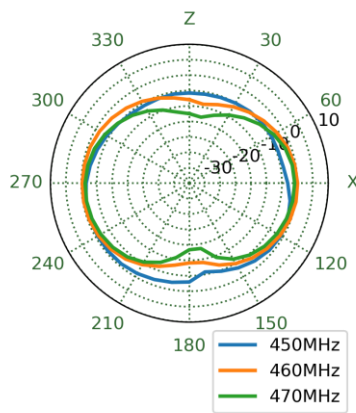

YZ Plane

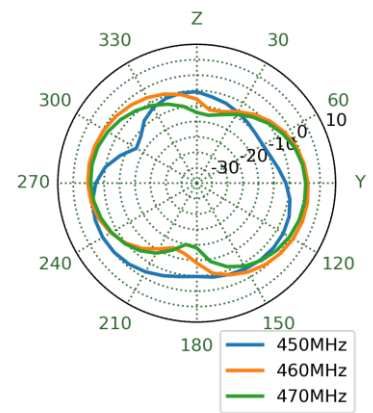

751MHz

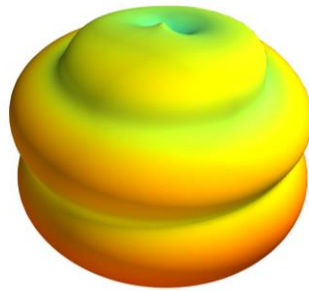

XY Plane

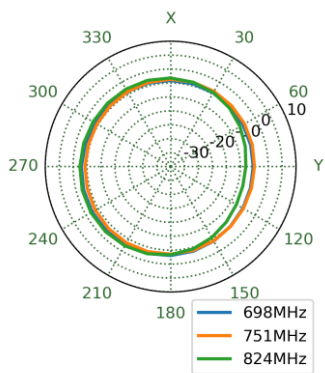

XZ Plane

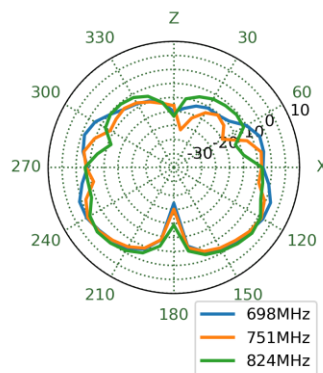

YZ Plane

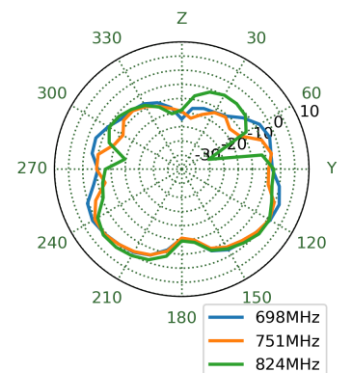

880MHz

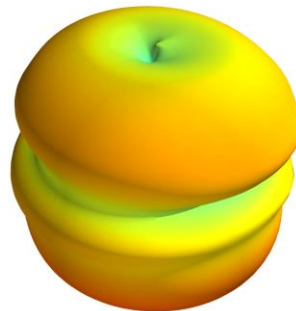

XY Plane

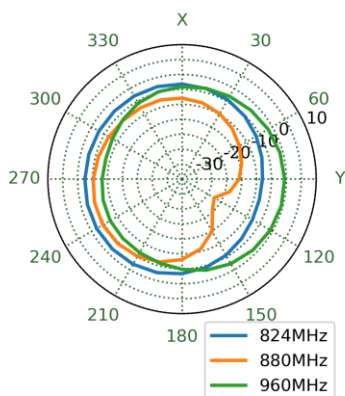

XZ Plane

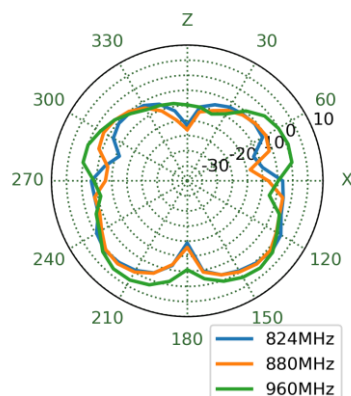

YZ Plane

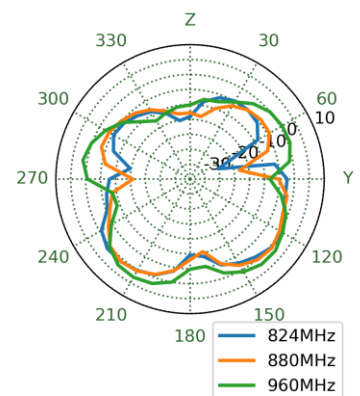

1930MHz

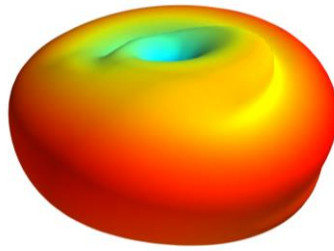

XY Plane

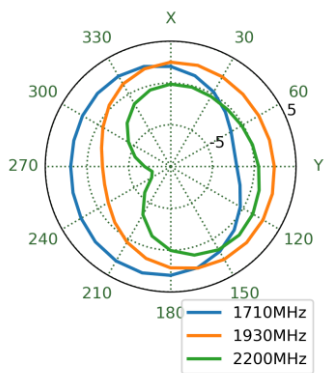

XZ Plane

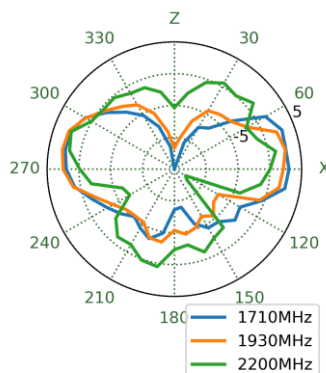

YZ Plane

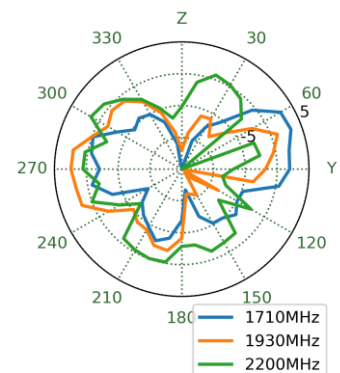

2496MHz

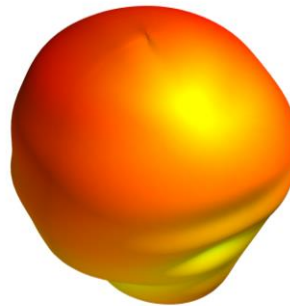

XY Plane

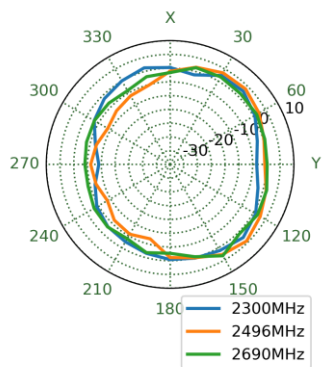

XZ Plane

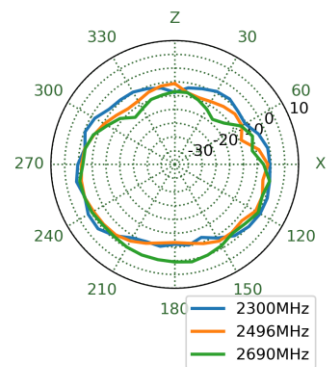

YZ Plane

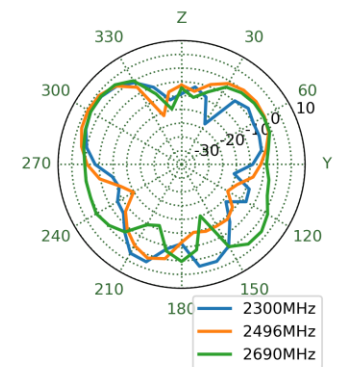

3550MHz

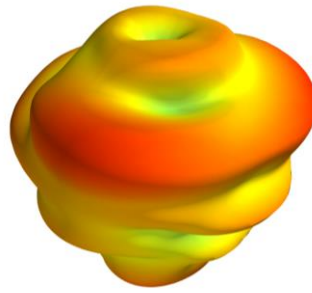

XY Plane

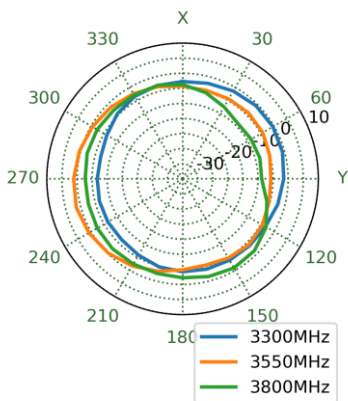

XZ Plane

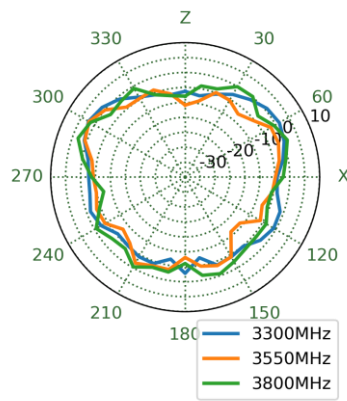

YZ Plane

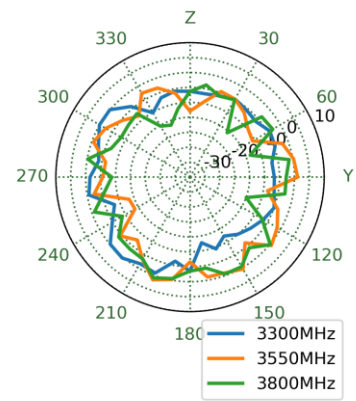

3700MHz

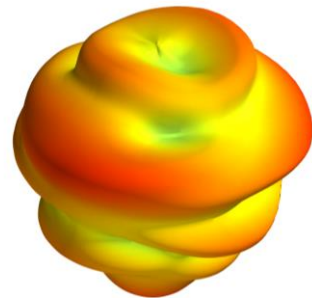

XY Plane

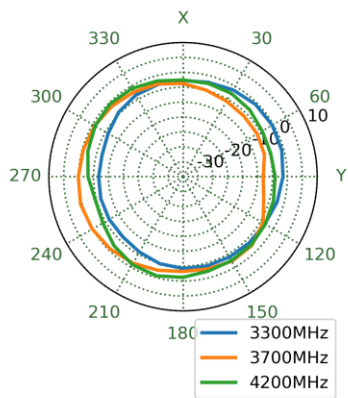

XZ Plane

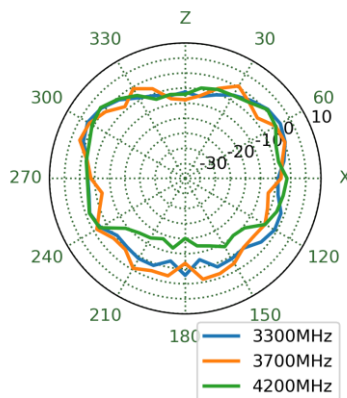

YZ Plane

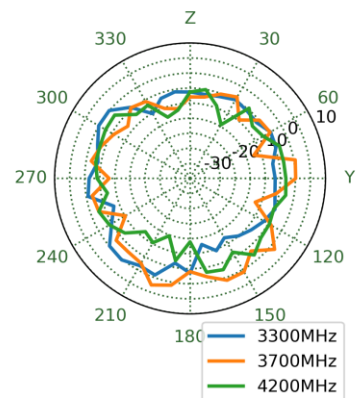

4800MHz

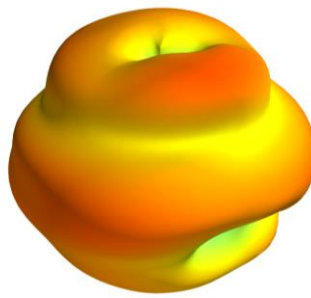

XY Plane

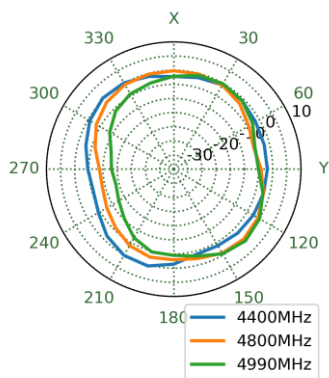

XZ Plane

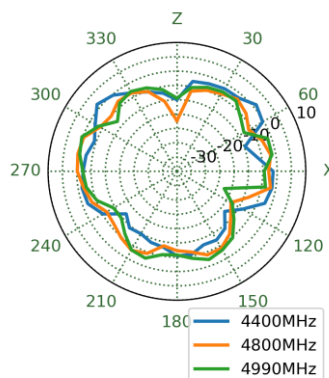

YZ Plane

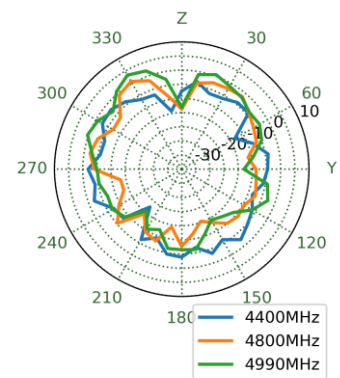

5550MHz

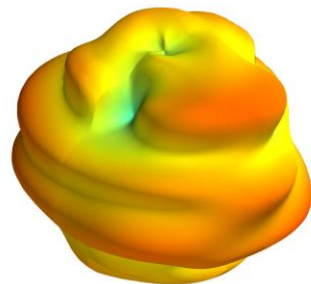

XY Plane

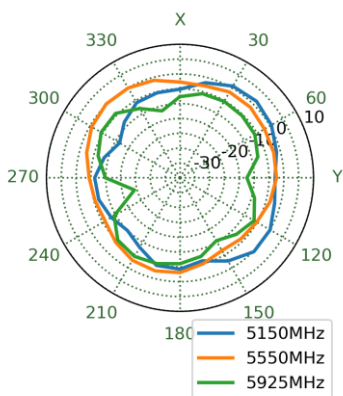

XZ Plane

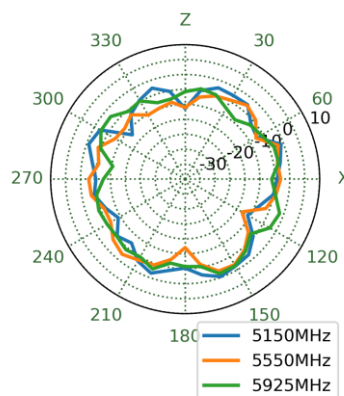

YZ Plane

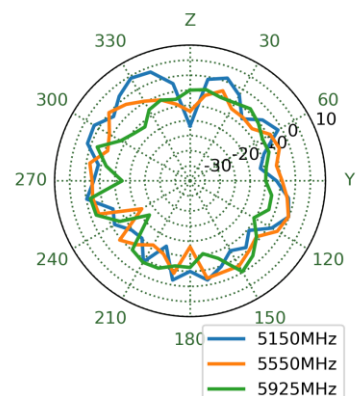

4.5 3D and 2D Radiation Patterns – Bent 150*90mm Ground Plane

450MHz

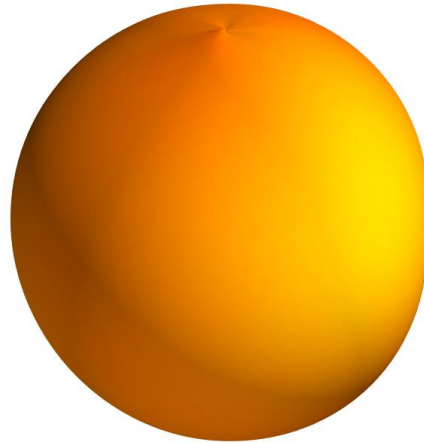

XY Plane

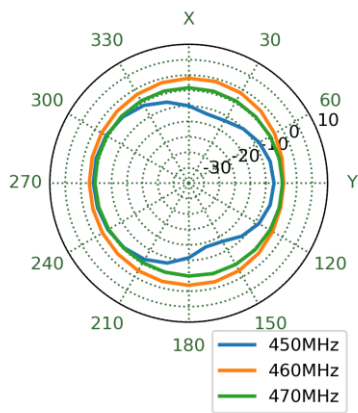

XZ Plane

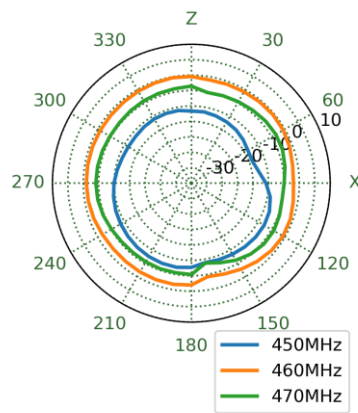

YZ Plane

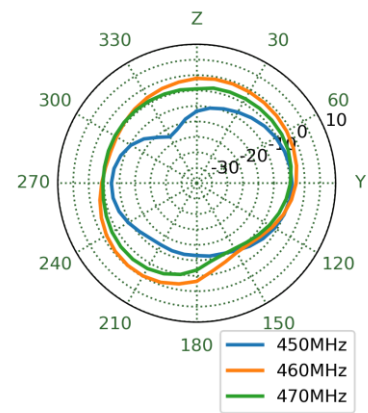

751MHz

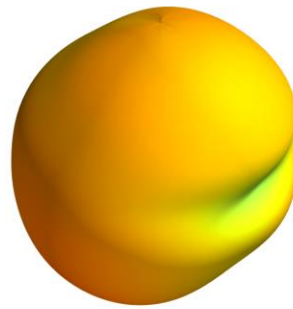

XY Plane

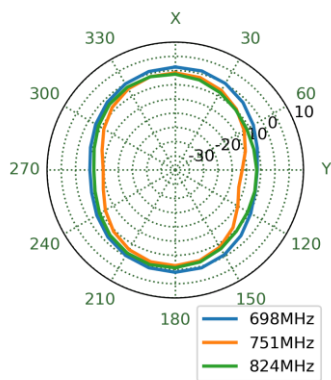

XZ Plane

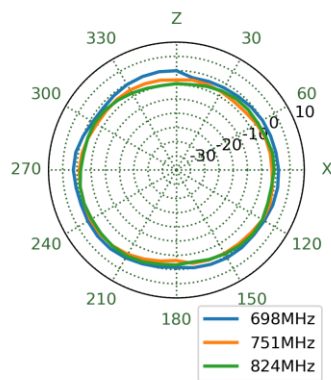

YZ Plane

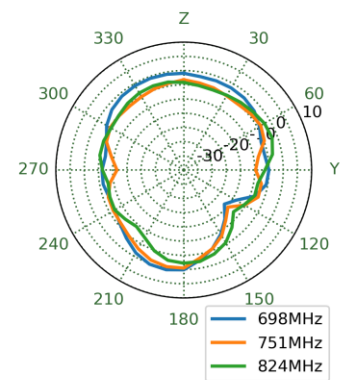

880MHz

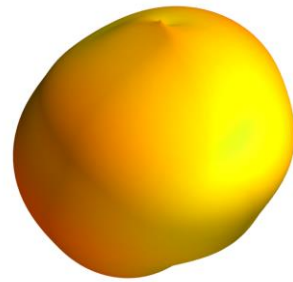

XY Plane

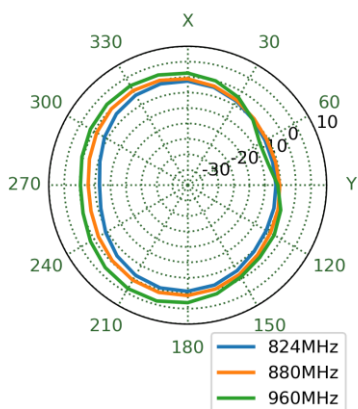

XZ Plane

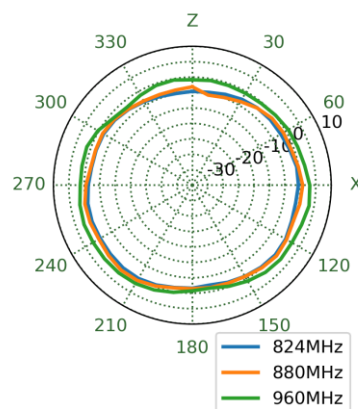

YZ Plane

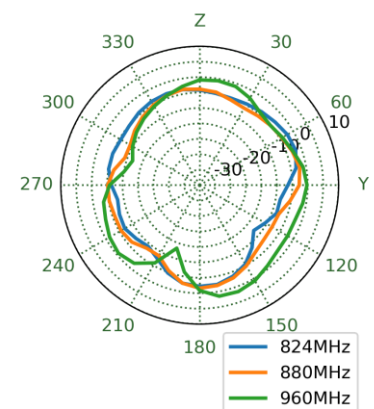

1930MHz

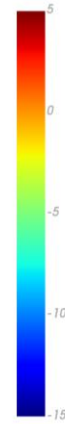
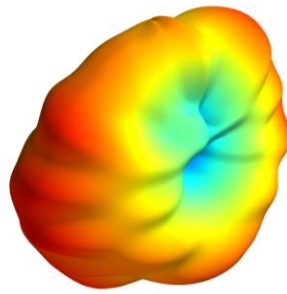

XY Plane

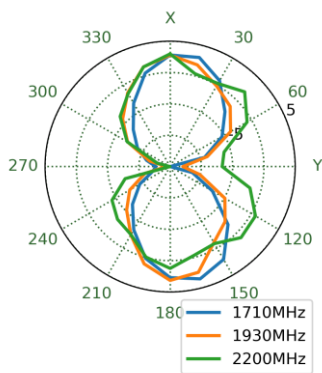

XZ Plane

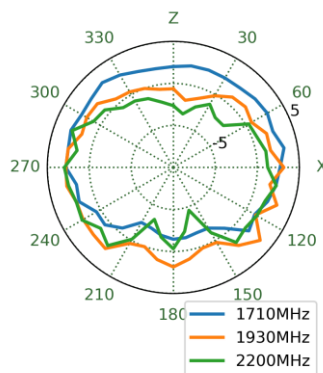

YZ Plane

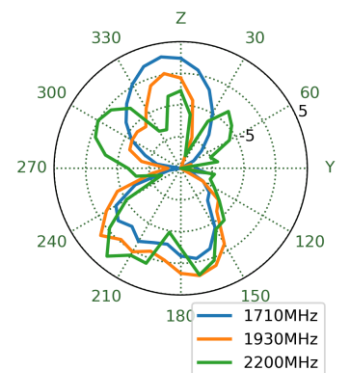

2496MHz

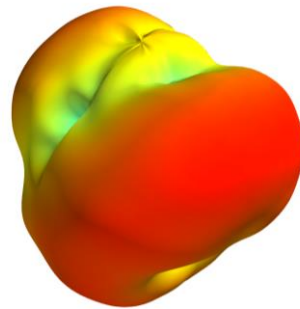

XY Plane

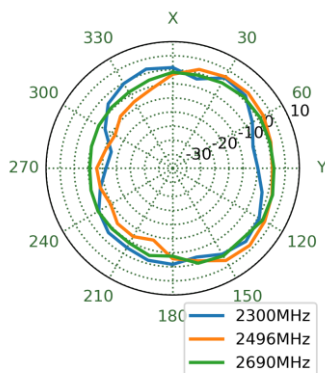

XZ Plane

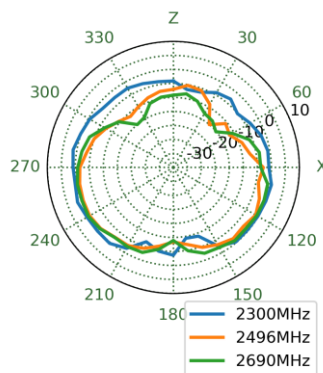

YZ Plane

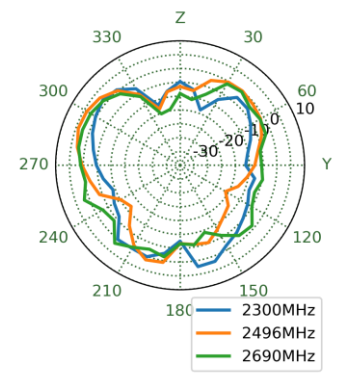

3550MHz

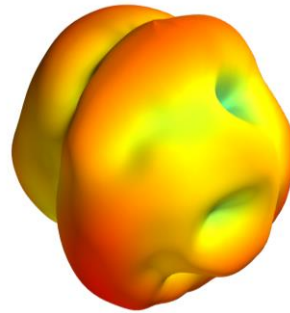

XY Plane

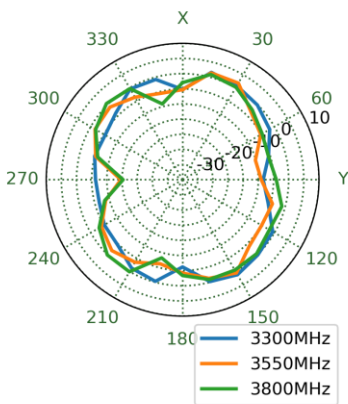

XZ Plane

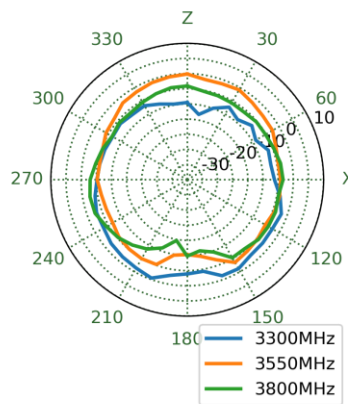

YZ Plane

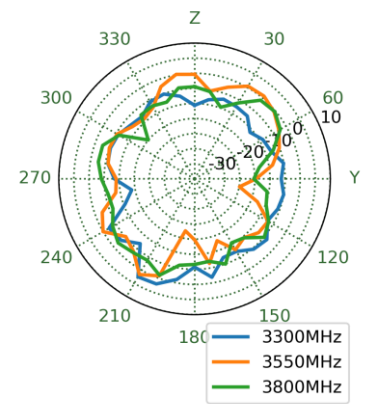

3700MHz

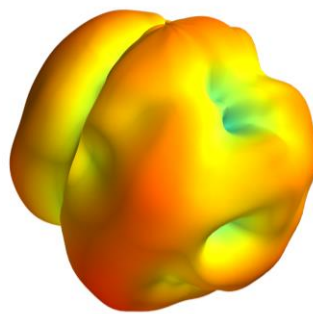

XY Plane

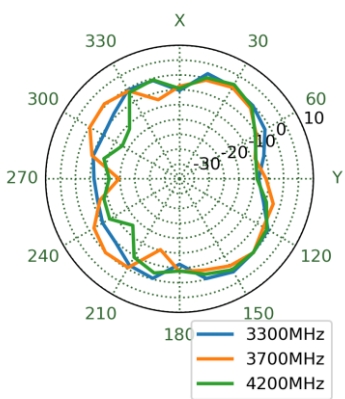

XZ Plane

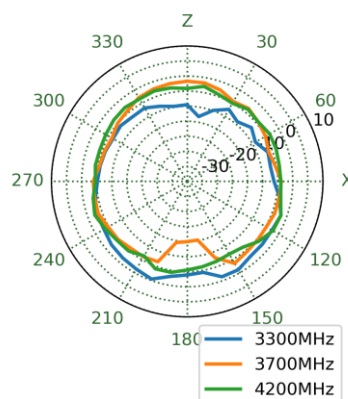

YZ Plane

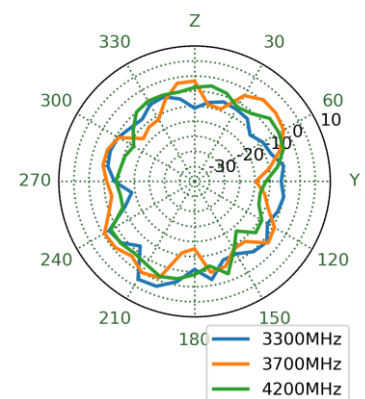

4800MHz

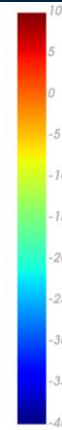
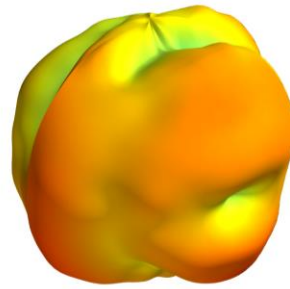

XY Plane

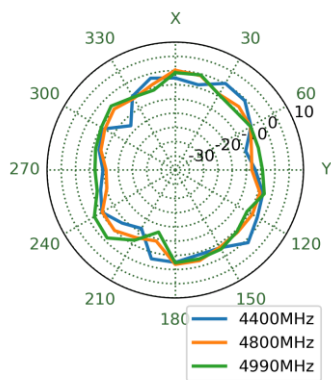

XZ Plane

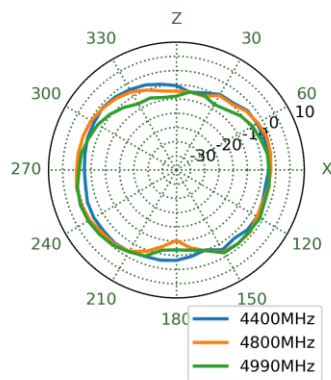

YZ Plane

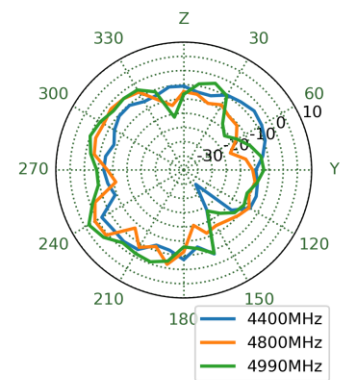

5550MHz

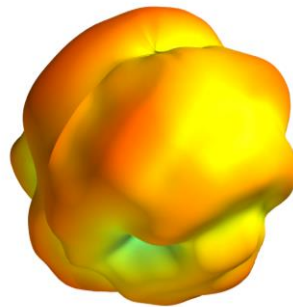

XY Plane

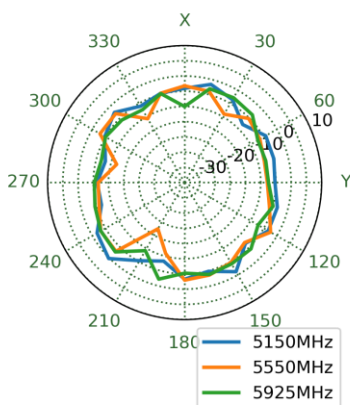

XZ Plane

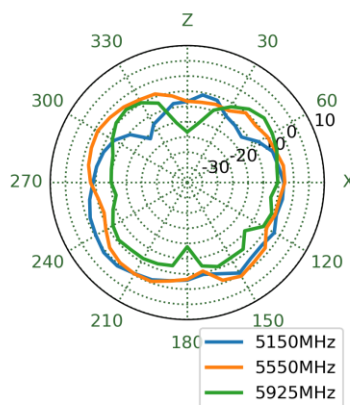

YZ Plane

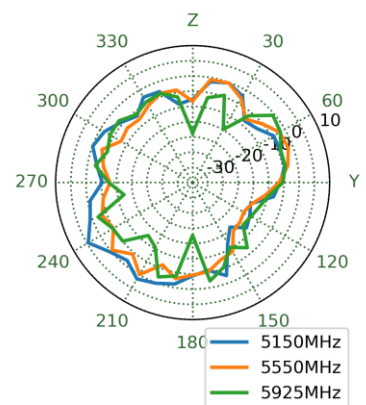

5. Mechanical Drawing (Units: mm)

ISO NO.: EDW-20-8-0090

STATE: Release

- NOTES:
1. All material must be RoHS compliant.
 2. Once product have any crack/break/thread damage or any structural tooling issue, molding supplier need to correct the issue unconditionally.
 3. Use this drawing together with the corresponding 3D CAD database file to fully describe the part.

REV.	DESCRIPTION	ENG.	APPROVED	DATE
01	Initial Design	Rachel Di	Aaron	2020/02/11
02	Change text description	Aron Yan	Aaron	2020/06/11

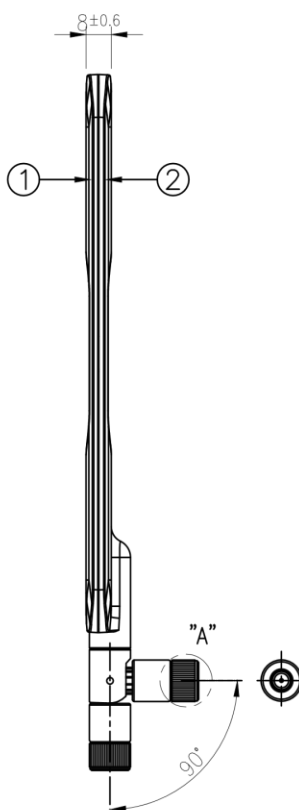
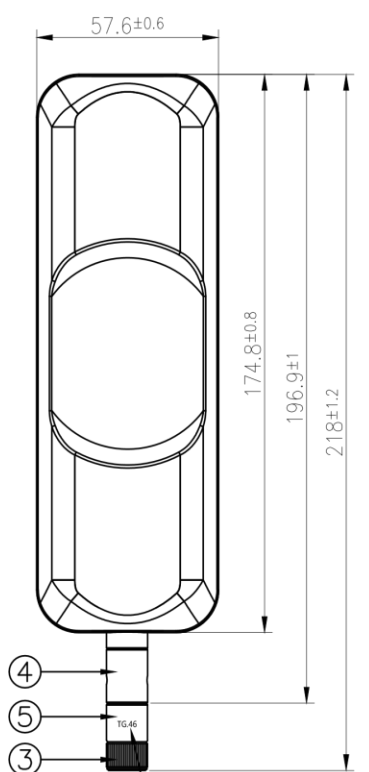
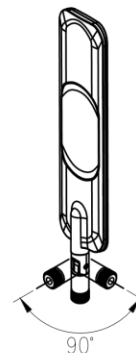

SMA(M)ST TG35/TG45 Thread

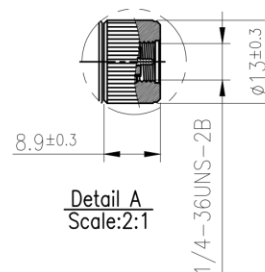

Silkscreen (White)

Item	Name	Material	Finish	QTY
1	Housing Top TG35/TG45	ABS	Black	1
2	Housing Bottom TG35/TG45	ABS	Black	1
3	SMA(M)ST TG35/TG45 Thread	Brass	Black	1
4	Hinge Top TG35/TG45 Type2	PP 8681	Black	1
5	Bottom hinge with TG46 silkscreen	No.5 Zinc Alloy	Black	1

APPROVED BY: Clark	<p>TW Design Centre This drawing and its inherent design concepts are property of Taoglas. Not to be copied or given to third parties without the written consent of Taoglas.</p>
CHECK BY: Aaron	
DRAWN BY: Rachel Di	
DATE: 2020/02/11	TITLE: Apex IV WideBand 5G/4G Dipole Terminal Antenna 90° Hinged R/A SMA(M) – with 450MHz
UNLESS OTHERWISE SPECIFIED TOLERANCES ON: XX:±0.5 X:±0.3 J:±0.2 JK:±0.1 J00K:±0.05	PART NO.: TG.46.8113
THIRD ANGLE PROJECTION	UNIT: mm SCALE: 1:2 PAGES: 1/1 REV: D02

6. TG.46 Installation Instructions

The TG.46 antenna has an independent rotating SMA connector which enables the user to install the antenna in their preferred orientation. Once tightened, the SMA connector will hold the antenna in place. The following illustrations show the TG.46 used on a wall mounted device as an example.

Step 1:

Adjust the antenna to the preferred orientation having placed it on the SMA(F) connector of the device.

Step 2:

While holding the antenna with one hand, rotate the SMA(M) connector with the other until it is fully tightened. When tightened with the required force, the antenna will hold its position without shifting, even when exposed to high vibration environments.

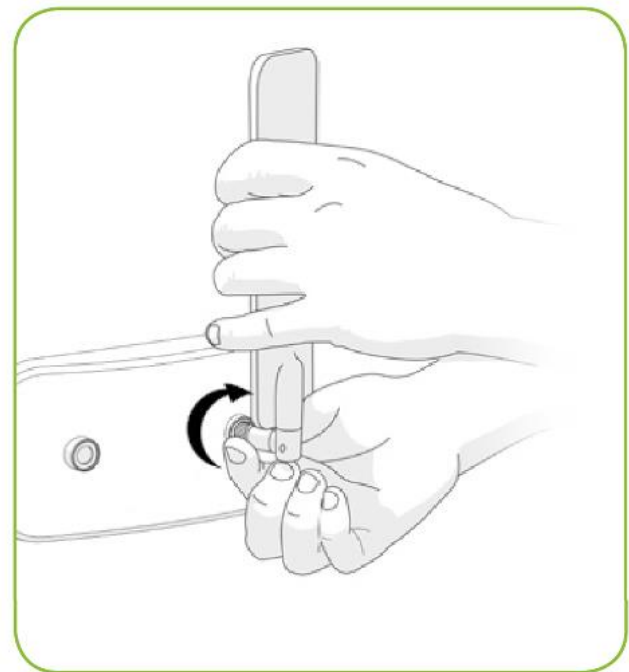
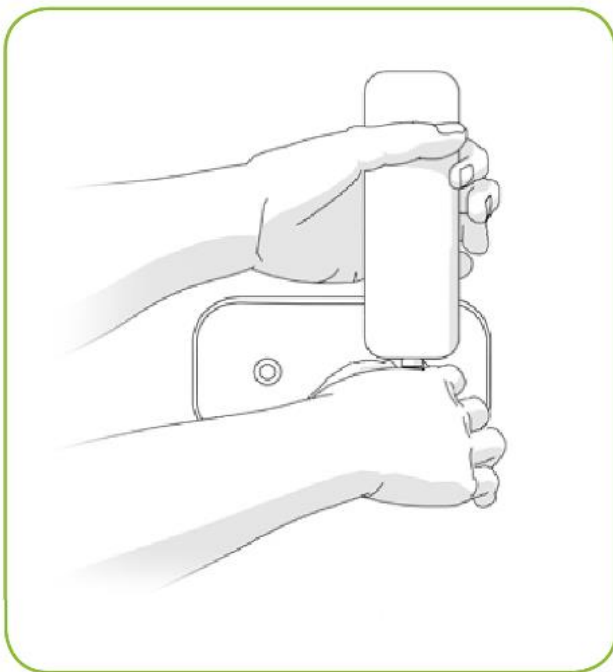

Note:

If using a torque wrench, the recommended force for mounting the antenna is 0.9Nm, maximum torque to prevent damage to the antenna is 1.17Nm.

7. Packaging

1pc TG.46.8113 per Small PE Bag with Video Link label
 Dimensions: 100*280mm
 Weight: 73.5g



25pcs per Large PE Bag
 Dimensions: 280*430mm
 Weight: 1.85Kg

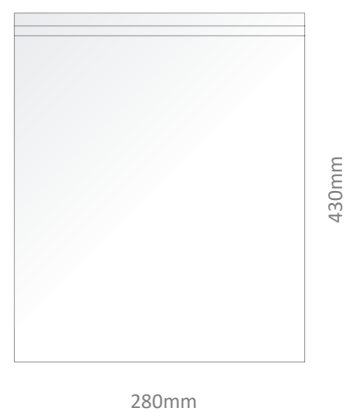

75pcs TG.46.8113 per Carton
 Carton Dimensions: 320*250*290mm
 Weight: 6.1Kg

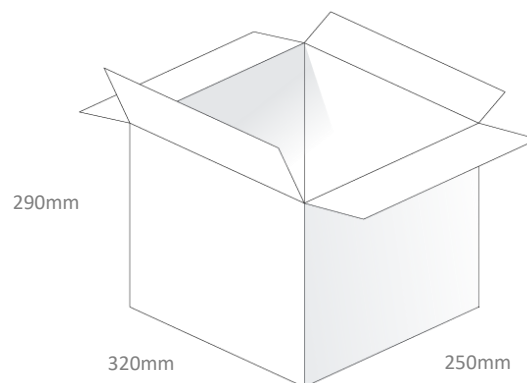

Changelog for the datasheet

SPE-20-8-094 – TG.46.8113

Revision: A (Original First Release)

Date:	2020-09-15
Notes:	
Author:	Jack Conroy

Previous Revisions
