

SMD Fibre Channel Modules

Single and Dual Core Solutions

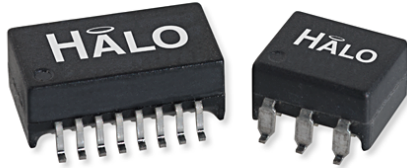

Product Features:

- Designed for Fibre Channel Applications
- UL/EN60950 Recognized
- Meets ANSI X3T11 Requirements
- 100% Compliance Testing
- 1500Vrms Hi-Pot
- Patented Open Frame Construction

Part Number	PRI OCL (μH min)	Rise Time 20 - 80% (ns max)	Cw/w (pF max)	PRI DCR (Ω max)	Baud Rate MHz	Circuit Diagram	Package	RoHS ¹
TG01-FC03NSLF	3.75	0.28	12	0.15	1062.500	A	NS	Pb-Free
TG01-FC03NSRL	3.75	0.28	12	0.15	1062.500	A	NS	RoHS (7a)
TG01-FC03N1LF	3.75	0.28	15	0.2	1062.500	B	N1	Pb-Free
TG01-FC03N1RL	3.75	0.28	15	0.2	1062.500	B	N1	RoHS (7a)
TG01-FC07NSLF	7.5	0.40	10	0.2	531.250	A	NS	Pb-Free
TG01-FC07NSRL	7.5	0.40	10	0.2	531.250	A	NS	RoHS (7a)
TG01-FC07N1LF	7.5	0.40	10	0.2	531.250	B	N1	Pb-Free
TG01-FC07N1RL	7.5	0.40	10	0.2	531.250	B	N1	RoHS (7a)
TG01-FC15NSLF	15	0.80	8	0.2	266.625	A	NS	Pb-Free
TG01-FC15NSRL	15	0.80	8	0.2	266.625	A	NS	RoHS (7a)
TG01-FC15N1LF	15	0.80	8	0.2	266.625	B	N1	Pb-Free
TG01-FC15N1RL	15	0.80	8	0.2	266.625	B	N1	RoHS (7a)
TG01-FC30NSLF	30	1.6	8	0.2	132.8125	A	NS	Pb-Free
TG01-FC30NSRL	30	1.6	8	0.2	132.8125	A	NS	RoHS (7a)
TG01-FC30N1LF	30	1.6	8	0.2	132.8125	B	N1	Pb-Free
TG01-FC30N1RL	30	1.6	8	0.2	132.8125	B	N1	RoHS (7a)

Notes:

1. Pb-Free parts are RoHS 6/6 compliant. RoHS (7a) parts contain lead per exemption 7a.
2. Parts with RL suffix are not recommended for new designs.
3. Please contact the factory or representative for individual datasheets or additional information.

SMD Fibre Channel Modules - Single and Dual Core Solutions

Circuit A

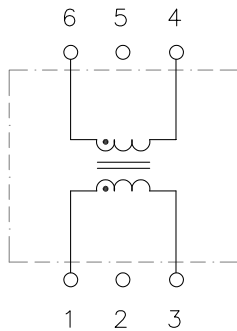

Circuit B

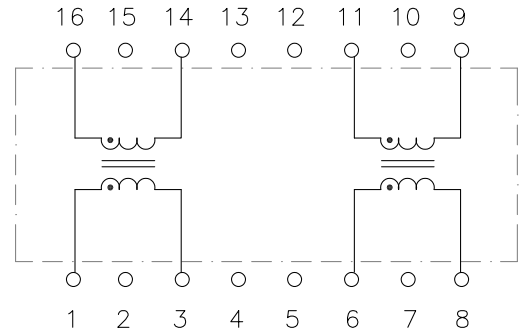

Package NS

Package N1

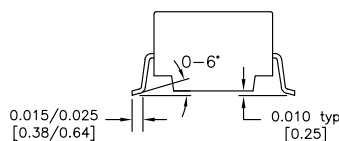
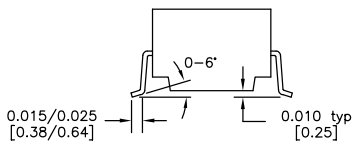
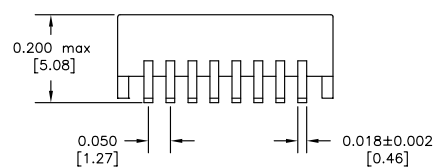
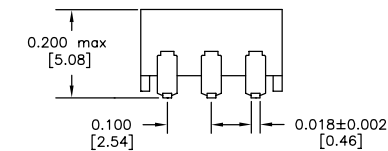
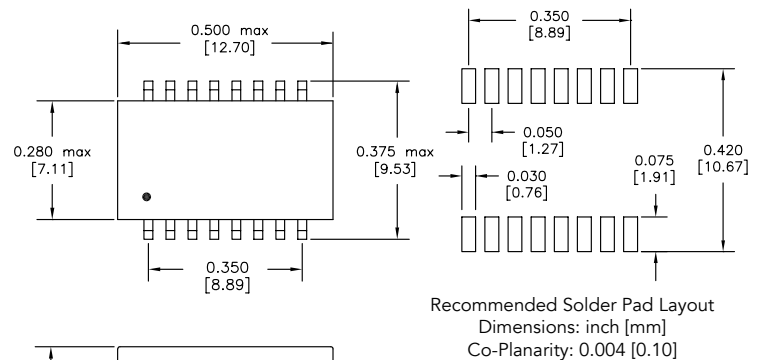
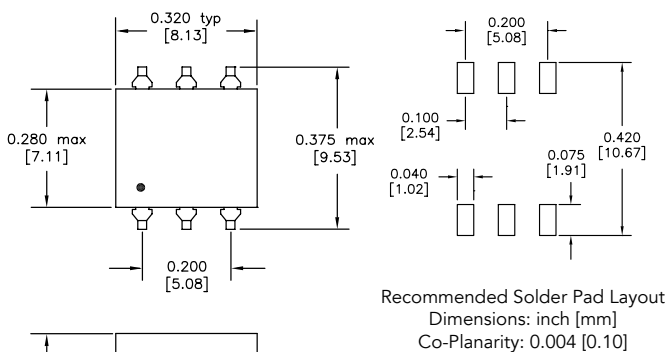

US Patent Numbers:
5,656,985 6,297,721 B1
6,297,720 B1 6,320,489 B1
6,344,785 B1 6,662,431 B1



2880 Lakeside Drive #116
Santa Clara, CA 95054
(650) 903-3800

www.haloelectronics.com

HALO® Electronics is a leading supplier of high quality communication magnetics including signal transformers, filters, CMR chokes, PoE power transformers, DC/DC converters, and integrated Ethernet connectors. HALO's leading edge technology solutions are manufactured in ISO9001 and ISO14001 factories offering high quality products at a competitive price.