

# T1/E1 Line Interface Modules

SMD Single Channel Transformer



## Product Features:

- T1, E1, CEPT and PRI ISDN Applications
- Available for All Popular LIU's
- 1500 Vrms Hi-Pot
- Patented Open Frame Construction
- UL/EN60950

Part Number	Schem.	Turns Ratio PRI/SEC	OCL (mH Typ)	Cw/w (pF max)	DCR Pri ( $\Omega$ max)	Primary Pins	Temperature Range <sup>2</sup>	RoHS <sup>1</sup>
TG02-1205NSLF	D	1CT:1	1.2	30	0.70	1-3	0 to 70°C	Pb-Free
TG02-1205NSRL	D	1CT:1	1.2	30	0.70	1-3	0 to 70°C	RoHS (7a)
TG04-1205NSLF	A	1CT:1CT	1.2	30	0.70	1-3	0 to 70°C	Pb-Free
TG04-1205NSRL	A	1CT:1CT	1.2	30	0.70	1-3	0 to 70°C	RoHS (7a)
TG04-1505NSLF	A	1CT:1CT	1.5	35	0.80	1-3	-40 to +85°C	Pb-Free
TG04-1505NSRL	A	1CT:1CT	1.5	35	0.80	1-3	-40 to +85°C	RoHS (7a)
TG08-1205NSLF	A	1CT:2CT	1.2	30	0.70	1-3	0 to 70°C	Pb-Free
TG08-1205NSRL	A	1CT:2CT	1.2	30	0.70	1-3	0 to 70°C	RoHS (7a)
TG10-1205NSLF	B	1:1:1	1.2	30	0.70	3-4	0 to 70°C	Pb-Free
TG10-1205NSRL	B	1:1:1	1.2	30	0.70	3-4	0 to 70°C	RoHS (7a)
TG15-1205NSLF	D	2CT:1	1.2	30	0.70	1-3	0 to 70°C	Pb-Free
TG15-1205NSRL	D	2CT:1	1.2	30	0.70	1-3	0 to 70°C	RoHS (7a)
TG23-1505NSLF	C	1:2.42CT	1.5	35	0.80	1-3	-40 to +85°C	Pb-Free
TG23-1505NSRL	C	1:2.42CT	1.5	35	0.80	1-3	-40 to +85°C	RoHS (7a)
TG37-1205NSLF	C	1:1.14CT	1.2	30	0.70	1-3	0 to 70°C	Pb-Free
TG37-1205NSRL	C	1:1.14CT	1.2	30	0.70	1-3	0 to 70°C	RoHS (7a)
TG38-1205NSLF	D	1:1.15CT	1.2	30	0.70	4-6	0 to 70°C	Pb-Free
TG38-1205NSRL	D	1:1.15CT	1.2	30	0.70	4-6	0 to 70°C	RoHS (7a)
TG42-1205NSLF	A	1CT:1.41CT	1.2	30	0.70	1-3	0 to 70°C	Pb-Free
TG42-1205NSRL	A	1CT:1.41CT	1.2	30	0.70	1-3	0 to 70°C	RoHS (7a)
TG70-1205NSLF	C	1:1.36CT	1.2	30	0.70	1-3	0 to 70°C	Pb-Free
TG70-1205NSRL	C	1:1.36CT	1.2	30	0.70	1-3	0 to 70°C	RoHS (7a)
TG71-1205NSLF	C	1:2.3CT	1.2	30	0.70	1-3	0 to 70°C	Pb-Free
TG71-1205NSRL	C	1:2.3CT	1.2	30	0.70	1-3	0 to 70°C	RoHS (7a)

### Notes:

1. Pb-Free parts are RoHS 6/6 compliant. RoHS (7a) parts contain lead per exemption 7a.
2. Extended temperature parts available. Contact factory for specific part numbers and datasheets.
3. Parts with RL suffix are not recommended for new designs.
4. Please contact the factory or representative for individual datasheets or additional information.

# T1/E1 Line Interface Modules

Schematic A

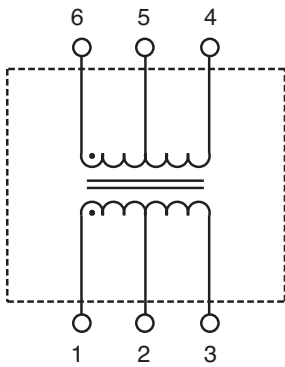

Schematic B

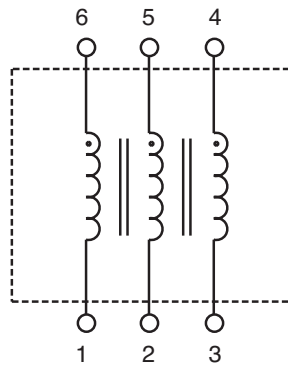

Schematic C

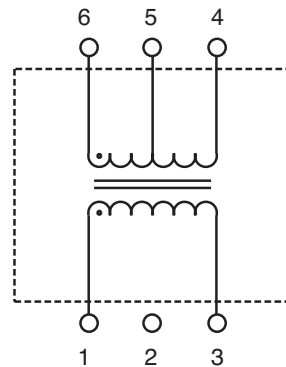

Schematic D

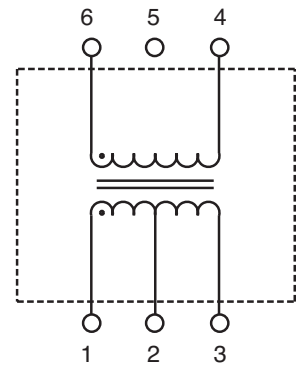

## Package NS

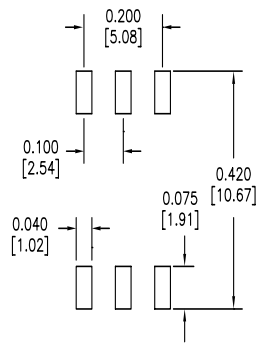
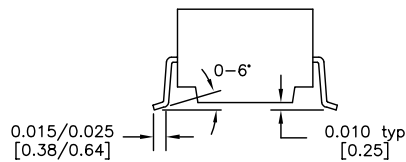
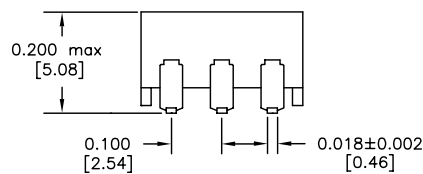
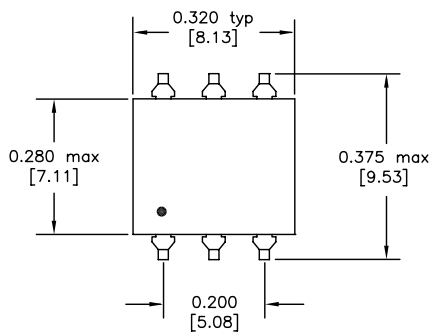

Recommended Solder Pad Dimensions

Dimensions: inch [mm]  
Co-Planarity: 0.004 [0.10]

US Patent Numbers

5,656,985 6,297,721 B1  
6,297,720 B1 6,320,489 B1  
6,344,785 B1 6,662,431 B1

**HALO**  
ELECTRONICS, INC.

2880 Lakeside Drive #116  
Santa Clara, CA 95054  
(650) 903-3800

[www.haloelectronics.com](http://www.haloelectronics.com)

HALO® Electronics is a leading supplier of high quality communication magnetics including signal transformers, filters, CMR chokes, PoE power transformers, DC/DC converters, and integrated Ethernet connectors. HALO's leading edge technology solutions are manufactured in ISO9001 and ISO14001 factories offering high quality products at a competitive price.

© Copyright 2017 HALO Electronics, Inc. All rights reserved.

Revised 9/2017. Download the latest version at [www.haloelectronics.com/pdf/discrete-smd6pin-t1.pdf](http://www.haloelectronics.com/pdf/discrete-smd6pin-t1.pdf)