

# Co-Directional Isolation Modules

Single or Dual Core SMD Packages

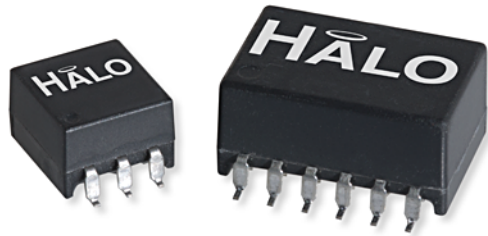

## Product Features:

- Standard series of SMD single and dual core Isolation Modules for ITU G.703 Codirectional applications up to 1.5Mbps.
- Designed for and approved by EXAR for use with the XRT6164 at data rates of 64Kbps and above.
- 1500Vrms Hi-Pot
- Operating Temp 0 to +70°C
- UL/EN60950 Recognized
- Patented Open Frame Construction

Part Number	PRI OCL (mH min)	Turns Ratio PRI:SEC	Primary Pins	LL (μH max)	Cw/w (pF max)	Circuit Schematic	RoHS
TG05-2004NARL	20	1:2CT	1-3	5.0	130	A	RoHS (7a)
TG05-2004NCLF	20	1:2CT	1-3 & 4-6	5.0	150	B	Pb-Free
TG05-2004NCRL	20	1:2CT	1-3 & 4-6	5.0	150	B	RoHS (7a)

### Notes:

1. Pb-Free parts are RoHS 6/6 compliant. RoHS (7a) parts contain lead per exemption 7a.
2. Parts with RL suffix are not recommended for new designs.
3. Please contact the factory or representative for individual datasheets or additional information.

Circuit A

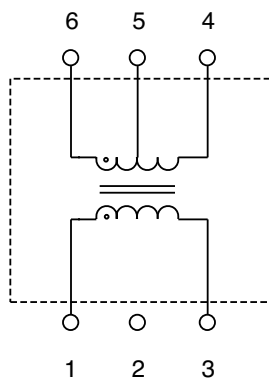

Circuit B

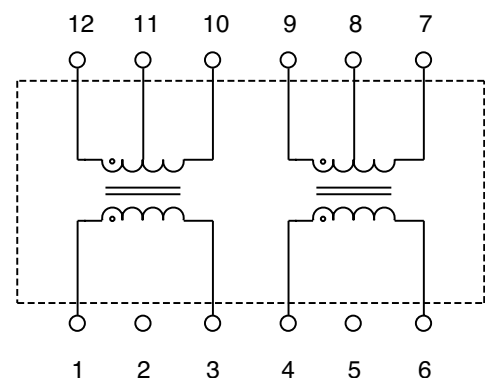

# Co-Directional Interface Isolation Modules

## Package NA

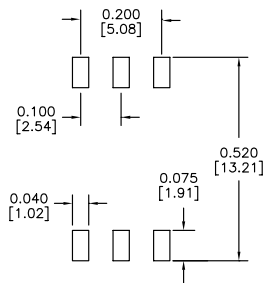
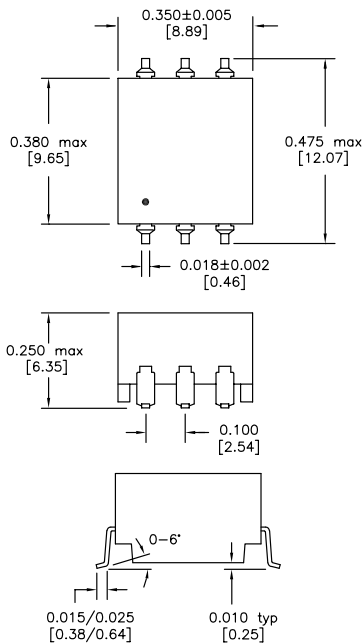

Recommended Solder Pad Dimensions

## Package NC

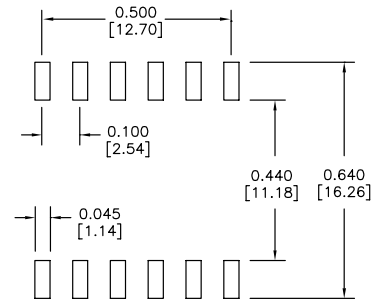
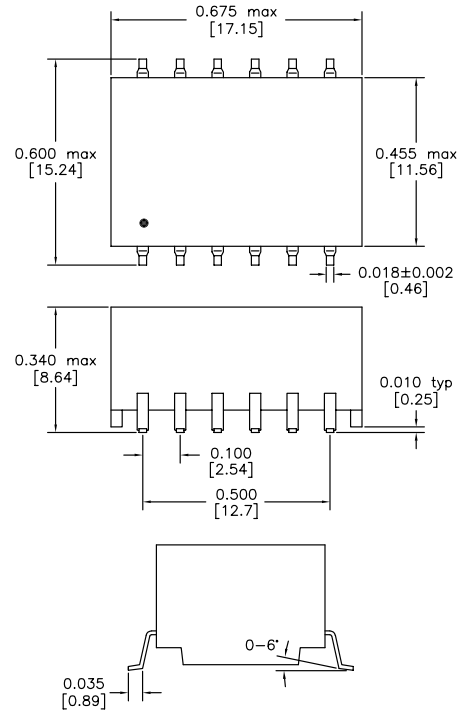

Recommended Solder Pad Dimensions

Dimensions: inch [mm]  
Co-Planarity: 0.004 [0.10]

### US Patent Numbers

5,656,985      6,297,721 B1  
6,297,720 B1      6,320,489 B1  
6,344,785 B1      6,662,431 B1



2880 Lakeside Drive #116  
Santa Clara, CA 95054  
(650) 903-3800

[www.haloelectronics.com](http://www.haloelectronics.com)

HALO® Electronics is a leading supplier of high quality communication magnetics including signal transformers, filters, CMR chokes, PoE power transformers, DC/DC converters, and integrated Ethernet connectors. HALO's leading edge technology solutions are manufactured in ISO9001 and ISO14001 factories offering high quality products at a competitive price.