

Dual Port GigE Transformer

SMD 48-Pin Dual Port Gig or Quad Port 10/100 Isolation Modules

HALO
ELECTRONICS, INC.

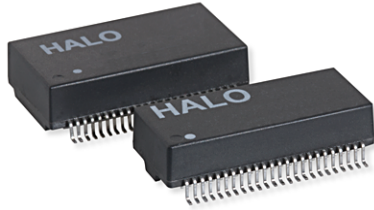

Product Features:

- Gigabit Ethernet Discrete Transformer
- IEEE802.3ab Compliant
- UL/EN60950 Recognized
- 100% Electrical Testing
- 1500Vrms Hi-Pot
- Patented Open Frame Construction

Part Number	Circuit	Package	Temp. Range ²	Return Loss (min)				RoHS ¹
				1-40MHz	60MHz	80MHz	100MHz	
TG1G-S201NV6LF	A	NV6	0 to 70°C	-18dB	-14dB	-12dB	-10dB	Pb-Free
TG1G-S201NV6RL	A	NV6	0 to 70°C	-18dB	-14dB	-12dB	-10dB	RoHS (7a)
TG1G-S202NV6LF	B	NV6	0 to 70°C	-18dB	-14dB	-12dB	-10dB	Pb-Free
TG1G-S202NV6RL	B	NV6	0 to 70°C	-18dB	-14dB	-12dB	-10dB	RoHS (7a)
TG1G-S205NV6LF	C	NV6	0 to 70°C	-18dB	-14dB	-12dB	-10dB	Pb-Free
TG1G-S205NV6RL	C	NV6	0 to 70°C	-18dB	-14dB	-12dB	-10dB	RoHS (7a)
TG1G-S212NV6LF	D	NV6	0 to 70°C	-18dB	-14dB	-12dB	-10dB	Pb-Free
TG1G-S212NV6RL	D	NV6	0 to 70°C	-18dB	-14dB	-12dB	-10dB	RoHS (7a)
TG1G-S231NVLF	A	NV	0 to 70°C	-18dB	-14dB	-12dB	-10dB	Pb-Free
TG1G-S231NVRL	A	NV	0 to 70°C	-18dB	-14dB	-12dB	-10dB	RoHS (7a)
TG1G-S232NVLF	B	NV	0 to 70°C	-18dB	-14dB	-12dB	-10dB	Pb-Free
TG1G-S232NVRL	B	NV	0 to 70°C	-18dB	-14dB	-12dB	-10dB	RoHS (7a)
TG1G-E201NV6LF	A	NV6	-40 to +85°C	-18dB	-14dB	-12dB	-10dB	Pb-Free
TG1G-E201NV6RL	A	NV6	-40 to +85°C	-18dB	-14dB	-12dB	-10dB	RoHS (7a)
TG1G-E212NV6LF	D	NV6	-40 to +85°C	-18dB	-14dB	-12dB	-10dB	Pb-Free
TG1G-E233NVLF	A	NV	-40 to +85°C	-18dB	-14dB	-12dB	-10dB	Pb-Free
TG1G-E233NVRL	A	NV	-40 to +85°C	-18dB	-14dB	-12dB	-10dB	RoHS (7a)
TG1G-E234NVLF	B	NV	-40 to +85°C	-18dB	-14dB	-12dB	-10dB	Pb-Free
TG1G-E234NVRL	B	NV	-40 to +85°C	-18dB	-14dB	-12dB	-10dB	RoHS (7a)

Notes:

1. Pb-Free parts are RoHS 6/6 compliant. RoHS (7a) parts contain lead per exemption 7a which is set to expire July 2016.
2. All 0 to 70°C parts can be used in -40 to +85°C applications. For more information contact the factory.
3. Parts with RL suffix are not recommended for new designs.
4. Please contact the factory or representative for individual datasheets or additional information.
5. For the smallest dual port Gigabit or quad port 10/100BASE-TX transformers contact the factory about the 50 pin package.

For additional information contact your [local representative](#), or HALO's support staff at (650) 903-3800 or info@haloelectronics.com

HALO Dual Port Gigabit Ethernet Transformers

Circuit A

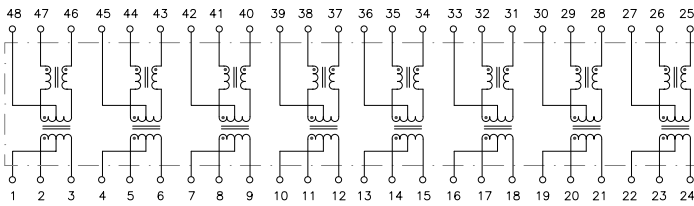

Circuit B

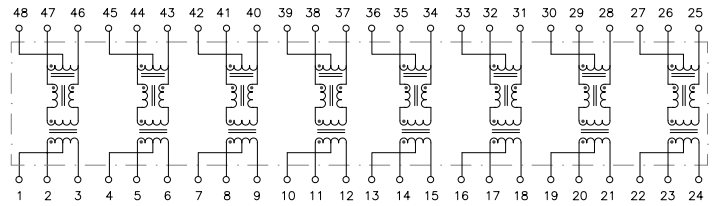

Circuit C

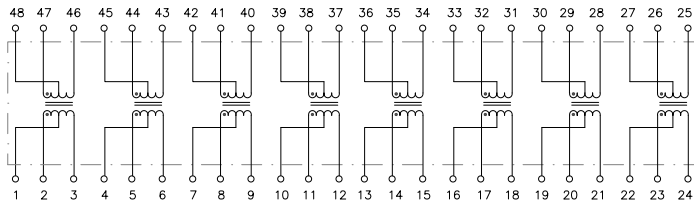

Circuit D

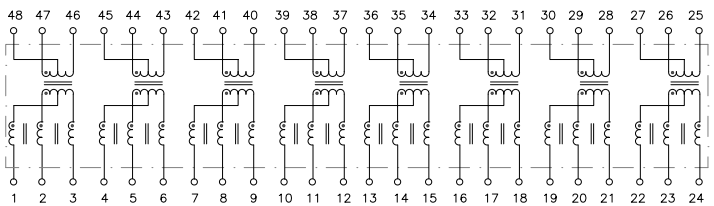

NV Package

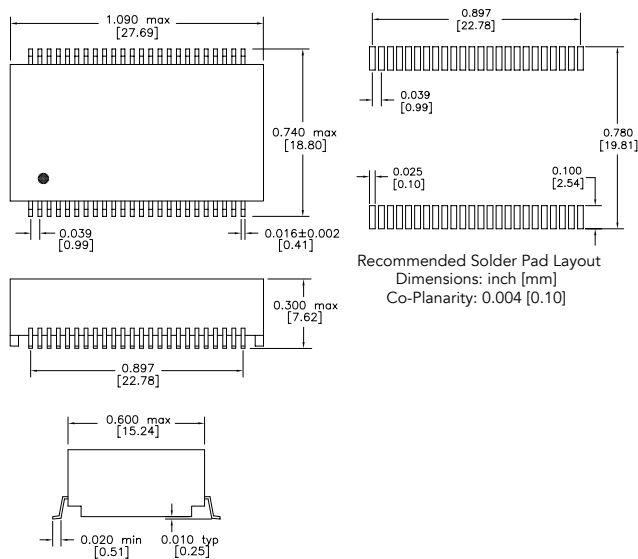

NV6 Package

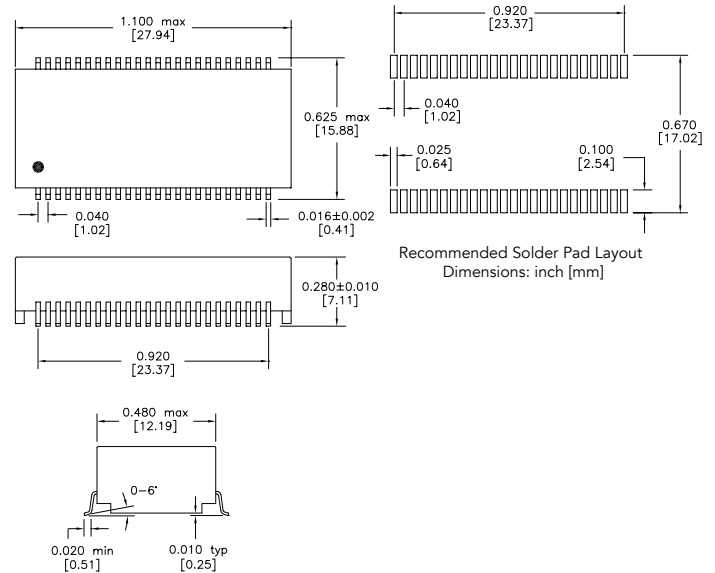

US Patent Numbers:
 5,656,985 6,297,721 B1
 6,297,720 B1 6,320,489 B1
 6,344,785 B1 6,662,431 B1



2880 Lakeside Drive #116
 Santa Clara, CA 95054
 (650) 903-3800

www.haloelectronics.com

HALO® Electronics is a leading supplier of high quality communication magnetics including signal transformers, filters, CMR chokes, PoE power transformers, DC/DC isolation modules, and integrated Ethernet connectors. HALO's high quality and competitively priced leading edge technology solutions are manufactured in ISO9001 and ISO14001 factories.

© Copyright 2017 HALO Electronics, Inc. All rights reserved.

Revised 8/2015REVC. Download the latest version at <http://www.haloelectronics.com/pdf/discrete-dual48-1gbaset.pdf>