

Product Overview

Qorvo’s TGA2224 is a wide band power amplifier MMIC fabricated on Qorvo’s production 0.15 um GaN on SiC process (QGaN15). Covering 32–38 GHz, the TGA2224 provides greater than 37 dBm (5 W) of saturated output power and 16 dB of large-signal gain while achieving > 20% power-added efficiency.

The TGA2224 RF ports are DC coupled to ground for improved ESD performance. Both ports are matched to 50 ohms. The TGA2224 can support a wide range of operating conditions, including CW operation, making it well-suited for both commercial and military systems.

Lead-free and RoHS compliant.



Key Features

- Frequency Range: 32 – 38 GHz
- P_{SAT} ($P_{IN}=21$ dBm): > 37 dBm
- PAE ($P_{IN}=21$ dBm): > 20 %
- Power Gain ($P_{IN}=21$ dBm): > 16 dB
- Small Signal Gain: > 25 dB
- Bias (pulsed): $V_D = 26$ V, $I_{DQ} = 320$ mA
- Bias (CW): $V_D = 24$ V, $I_{DQ} = 320$ mA
- Die Dimensions: 3.43 x 1.47 x 0.05 mm

Performance is typical across frequency. Please reference electrical specification table and data plots for more details.

Functional Block Diagram

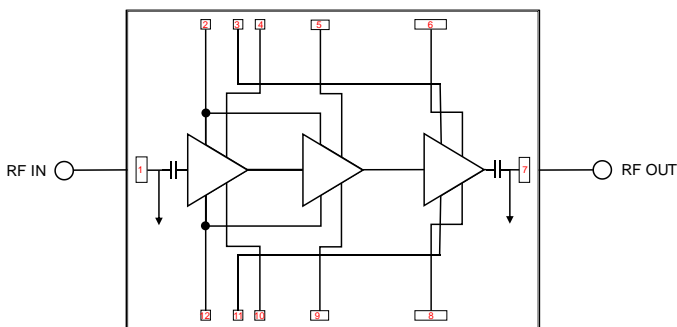

Applications

- Communications
- Radar
- Satcom
- EW
- Space communications
- Point to point communications

Ordering Information

Part No.	Description
TGA2224	32 – 38 GHz 10 W GaN Amplifier (10 Pcs.)
TGA2224EVB1	Evaluation Board for TGA2224

Absolute Maximum Ratings

Parameter	Value / Range
Drain Voltage (V_D)	29.5 V
Gate Voltage Range (V_G)	-4 V to 0 V
Drain Current ($I_{D1}/I_{D2}/I_{D3}$) (T=85 °C)	0.53 / 0.85 / 1.72 A
Gate Current (I_G)	See plot pg. 16
Power Dissipation (P_{DISS}), 85 °C	30 W
Input Power (P_{IN}), 50 Ω , CW, $V_D=24$ V, $I_{DQ}=320$ mA, 85 °C	27 dBm
Input Power (P_{IN}), 3:1 VSWR, CW, $V_D=24$ V, $I_{DQ}=320$ mA, 85 °C	27 dBm
Soldering Temperature (30 seconds, maximum)	320 °C
Storage Temperature	-55 to +125 °C

Operation of this device outside the parameter ranges given above may cause permanent damage. These are stress ratings only, and functional operation of the device at these conditions is not implied.

Recommended Operating Conditions

Parameter	Value / Range
Drain Voltage (V_D , Pulsed)	26 V
Drain Voltage (V_D , CW)	24 V
Drain Current (I_{DQ})	320 mA
Operating Temperature	-40 to +85 °C

Electrical specifications are measured at specified test conditions. Specifications are not guaranteed over all recommended operating conditions.

Electrical Specifications (Pulsed)

Parameter		Min	Typ	Max	Units
Operational Frequency		32		38	GHz
Output Power ($P_{IN} = 21$ dBm) (Pulsed, $V_D = 26$ V)	32 GHz		37.8		dBm
	35 GHz		38.9		dBm
	38 GHz		38.7		dBm
Power Added Efficiency ($P_{IN} = 21$ dBm) (Pulsed, $V_D = 26$ V)	32 GHz		20.0		%
	35 GHz		24.4		%
	38 GHz		26.7		%
Small Signal Gain (CW, $V_D = 26$ V)	32 GHz		30.2		dB
	35 GHz		27.9		dB
	38 GHz		23.5		dB
Input Return Loss (CW, $V_D = 26$ V)	32 GHz		10		dB
	35 GHz		10		dB
	38 GHz		13		dB
Output Return Loss (CW, $V_D = 26$ V)	32 GHz		11		dB
	35 GHz		13		dB
	38 GHz		10		dB
Output Power Temp. Coeff. (85 °C to 25 °C, $V_D = 26$ V (pulsed), $P_{IN} = 21$ dBm)			-0.006		dB/°C
Sm. Sig. Gain Temp. Coefficient (85 °C to -40 °C, CW, $V_D = 26$ V)			-0.089		dB/°C

Test conditions, unless otherwise noted: T = 25 °C, $V_D = 26$ V, $I_{DQ} = 320$ mA, PW = 100 us, Duty Cycle = 10%

Electrical Specifications (CW)

Parameter		Min	Typ	Max	Units
Operational Frequency		32		38	GHz
Output Power ($P_{IN} = 21$ dBm) (CW, $V_D = 24$ V)	32 GHz		38.1		dBm
	35 GHz		38.6		dBm
	38 GHz		37.7		dBm
Power Added Efficiency ($P_{IN} = 21$ dBm) (CW, $V_D = 24$ V)	32 GHz		25.6		%
	35 GHz		26.6		%
	38 GHz		26.3		%
Small Signal Gain ($V_D = 24$ V)	32 GHz		30.2		dB
	35 GHz		27.5		dB
	38 GHz		22.0		dB
Input Return Loss ($V_D = 24$ V)	32 GHz		10		dB
	35 GHz		10		dB
	38 GHz		12		dB
Output Return Loss ($V_D = 24$ V)	32 GHz		11		dB
	35 GHz		13		dB
	38 GHz		8		dB
Output Power Temp. Coeff. (85 °C to 25 °C, $V_D = 24$ V (CW), $P_{IN} = 21$ dBm)			-0.018		dB/°C
Sm. Sig. Gain Temp. Coefficient (85 °C to -40 °C, $V_D = 24$ V)			-0.088		dB/°C

Test conditions, unless otherwise noted: T = 25 °C, $V_D = 24$ V, $I_{DQ} = 320$ mA

Performance Plots – Large Signal (Pulsed)

Test conditions, unless otherwise noted: $V_D=26\text{ V}$, $I_{DQ}=320\text{ mA}$, $T=+25\text{ }^\circ\text{C}$, $P_{IN}=21\text{ dBm}$, $PW=100\text{ }\mu\text{s}$, Duty Cycle=10%

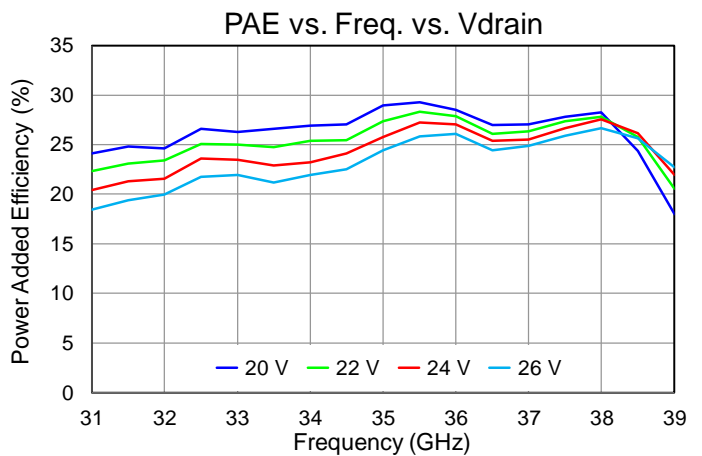
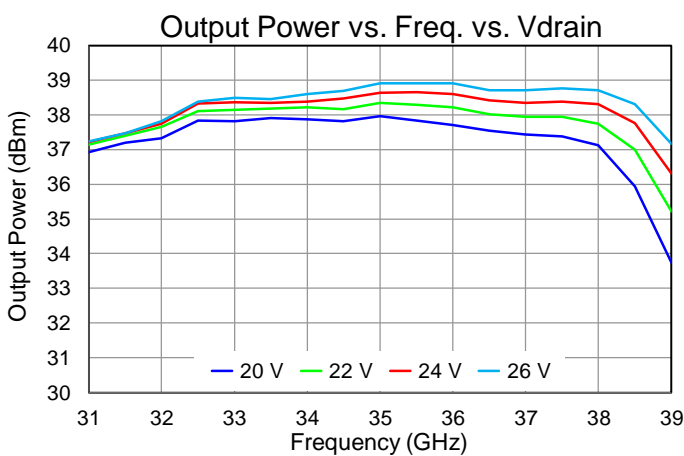
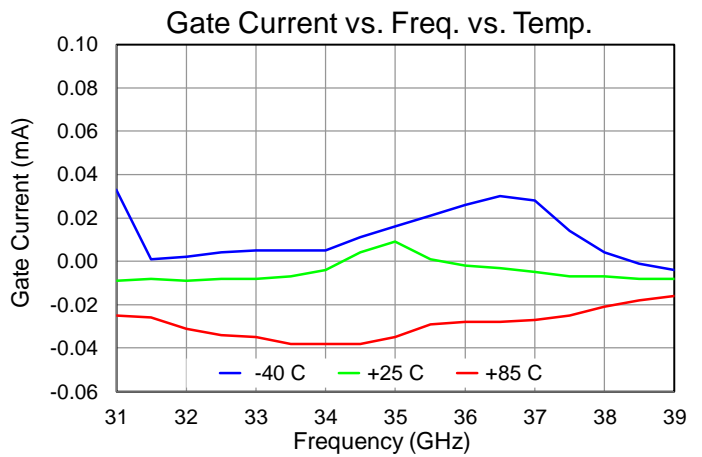
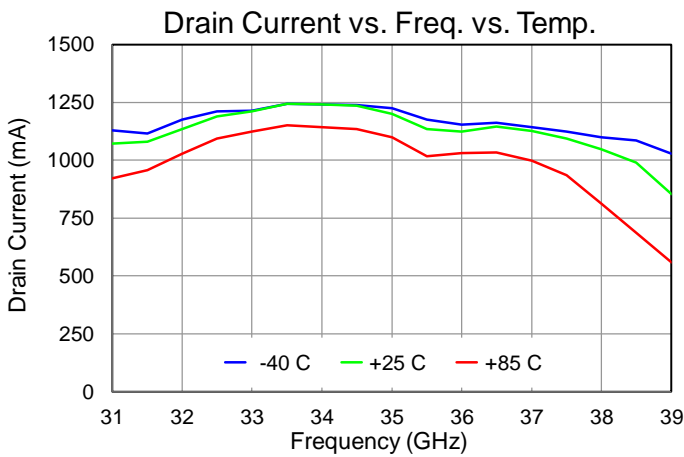
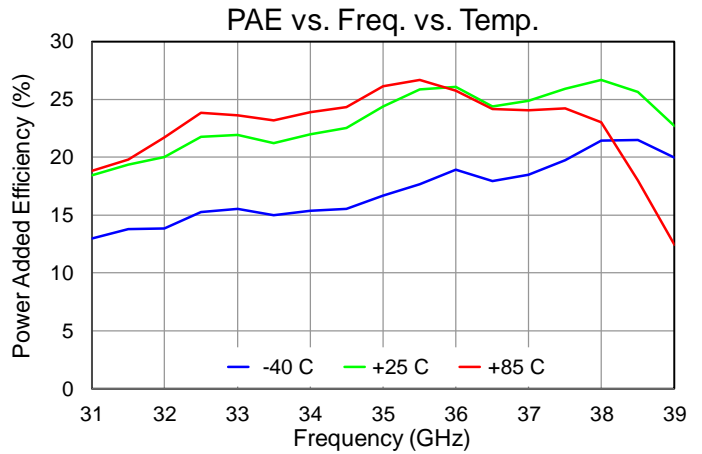
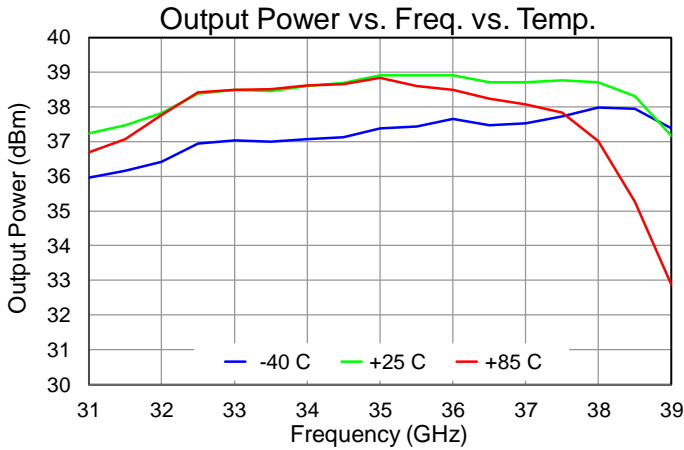

Performance Plots – Large Signal (Pulsed)

Test conditions, unless otherwise noted: $V_D=26\text{ V}$, $I_{DQ}=320\text{ mA}$, $T=+25\text{ }^\circ\text{C}$, $P_{IN}=21\text{ dBm}$, $PW=100\text{ }\mu\text{s}$, Duty Cycle=10%

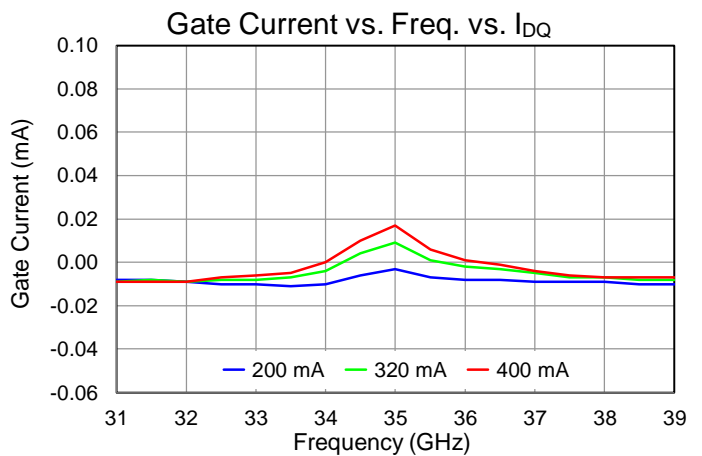
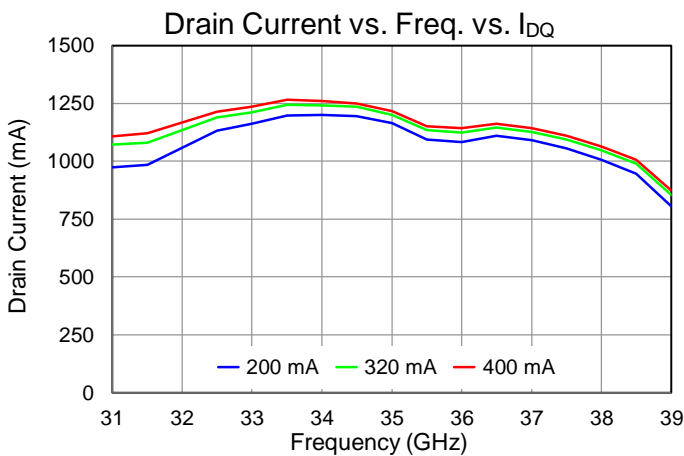
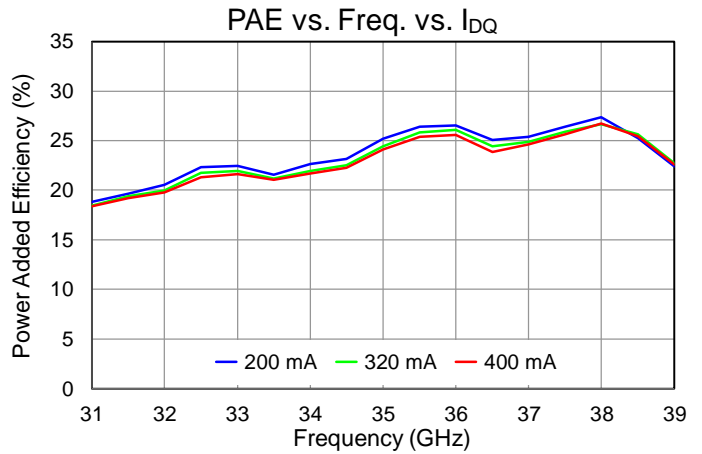
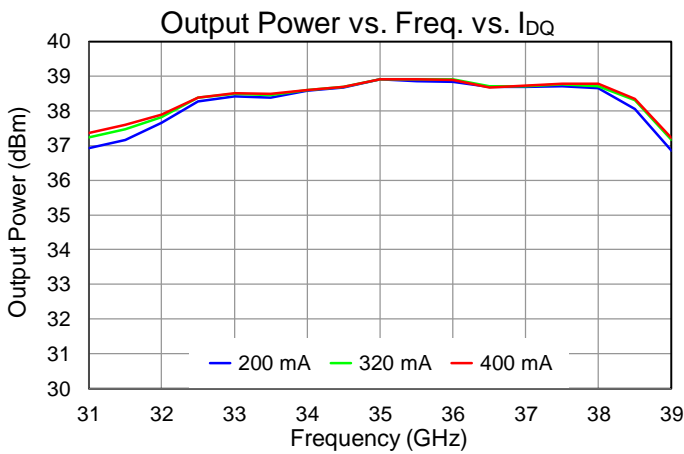
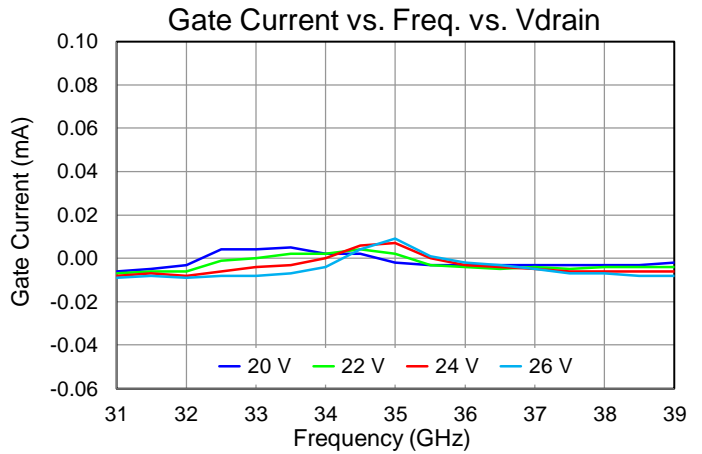
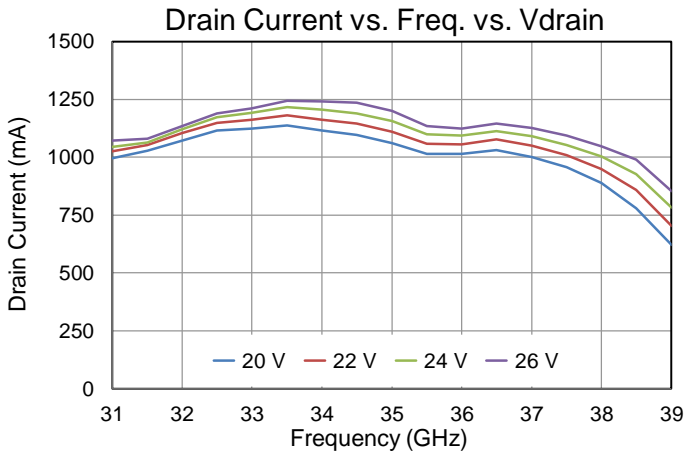

Performance Plots – Large Signal (Pulsed)

Test conditions, unless otherwise noted: $V_D=26\text{ V}$, $I_{DQ}=320\text{ mA}$, $T=+25\text{ }^\circ\text{C}$, $PW=100\text{ }\mu\text{s}$, Duty Cycle=10%

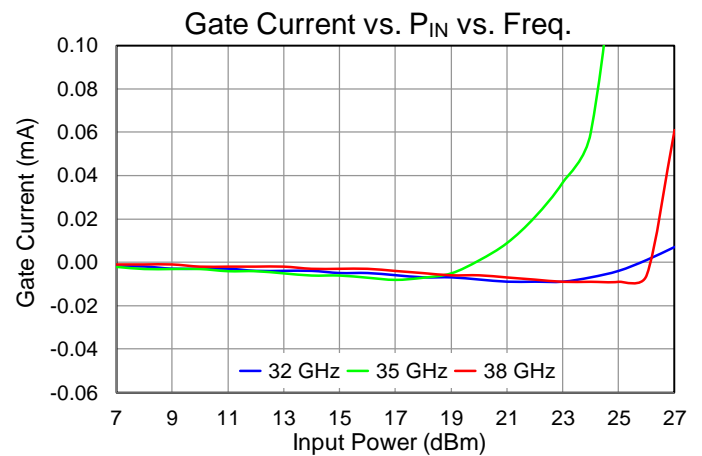
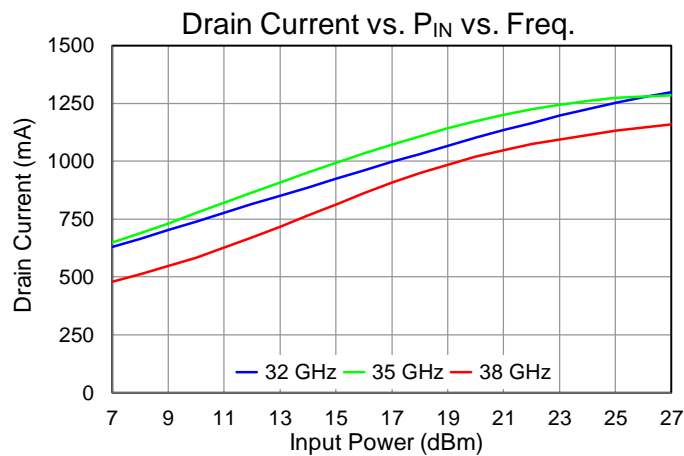
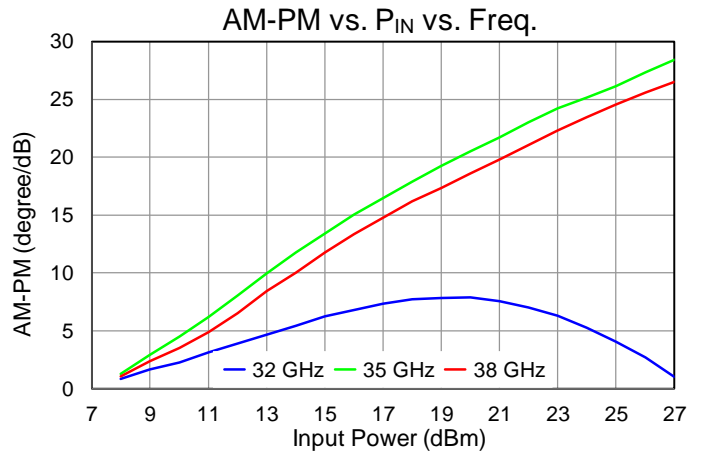
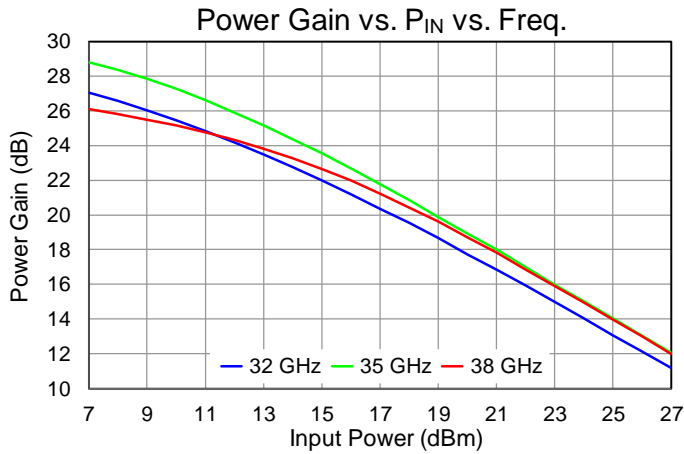
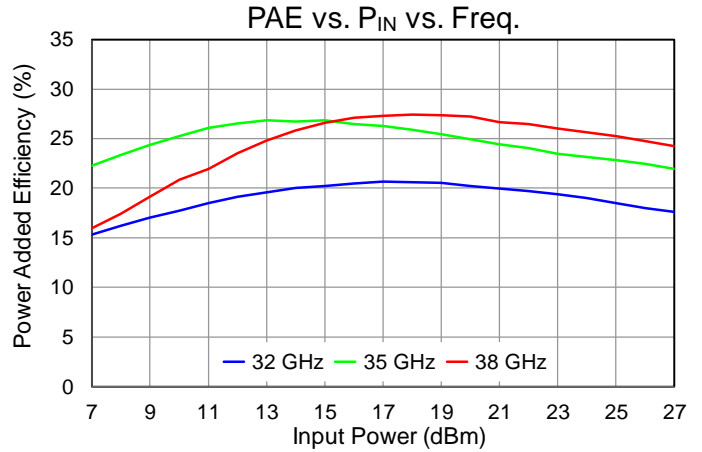
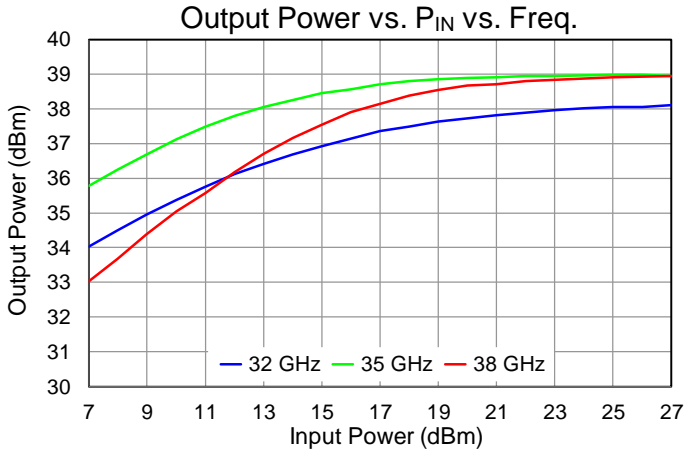

Performance Plots – Large Signal (Pulsed)

Test conditions, unless otherwise noted: $V_D=26\text{ V}$, $I_{DQ}=320\text{ mA}$, $T=+25\text{ }^\circ\text{C}$, $PW=100\text{ }\mu\text{s}$, Duty Cycle=10%, Freq.=35 GHz

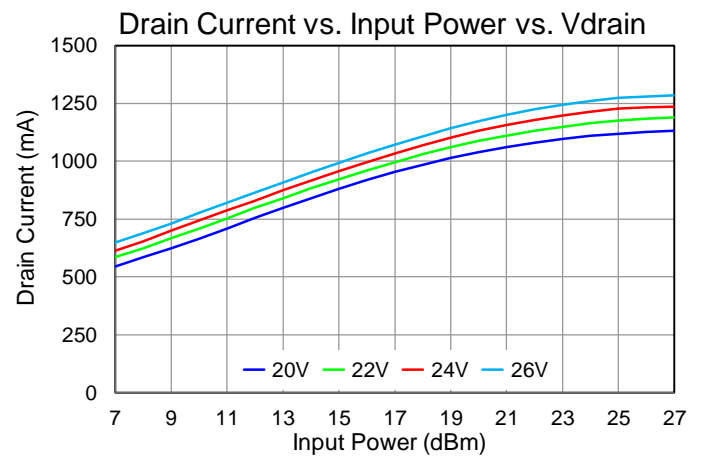
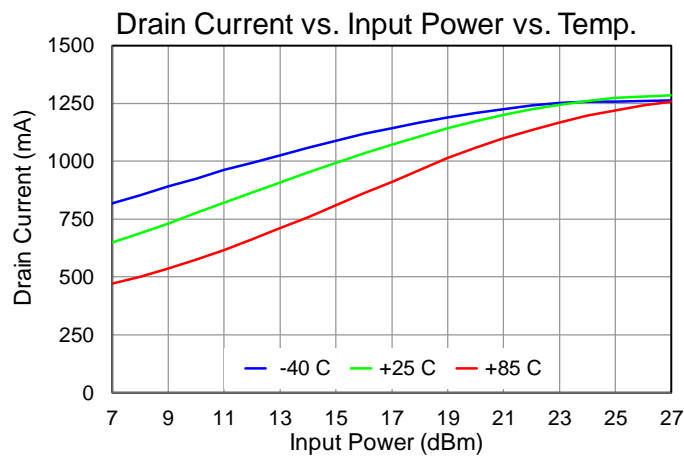
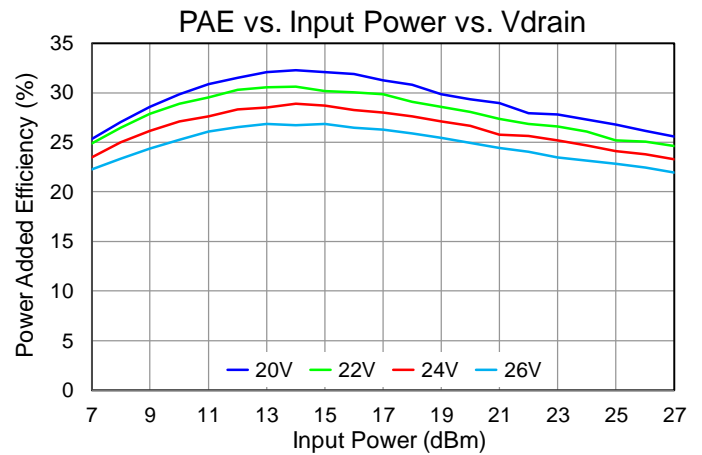
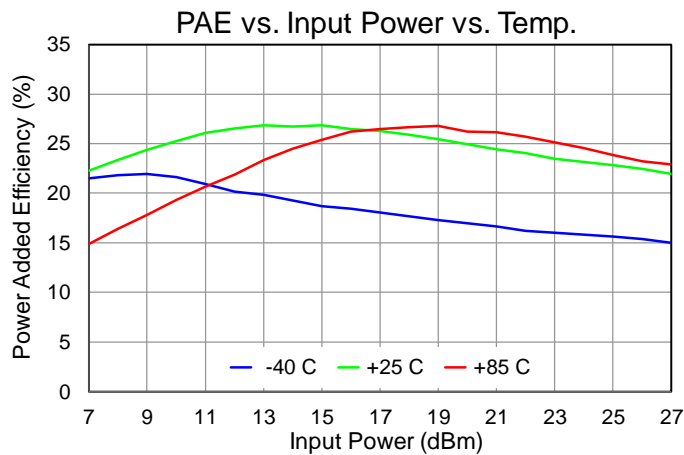
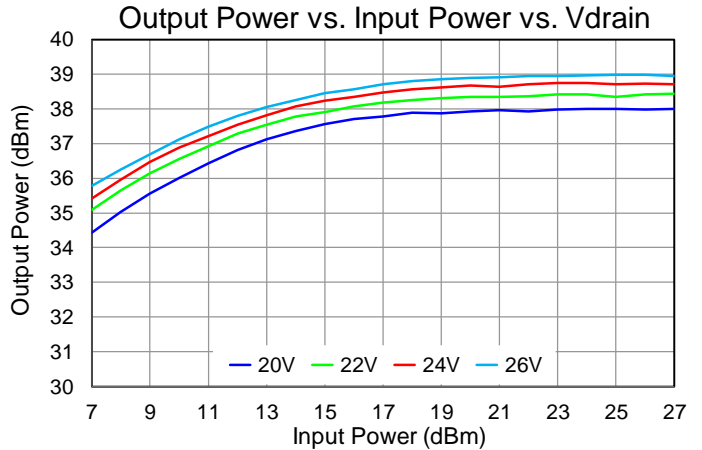
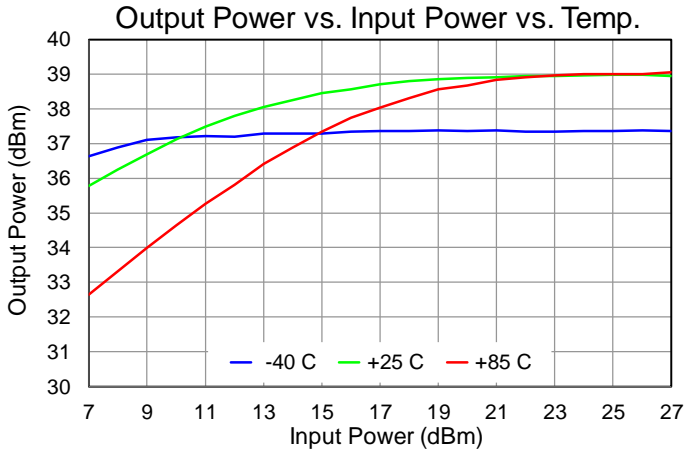

Performance Plots – Large Signal (Pulsed)

Test conditions, unless otherwise noted: $V_D=26\text{ V}$, $I_{DQ}=320\text{ mA}$, $T=+25\text{ }^\circ\text{C}$, $PW=100\text{ }\mu\text{s}$, Duty Cycle=10%, Freq.=35 GHz

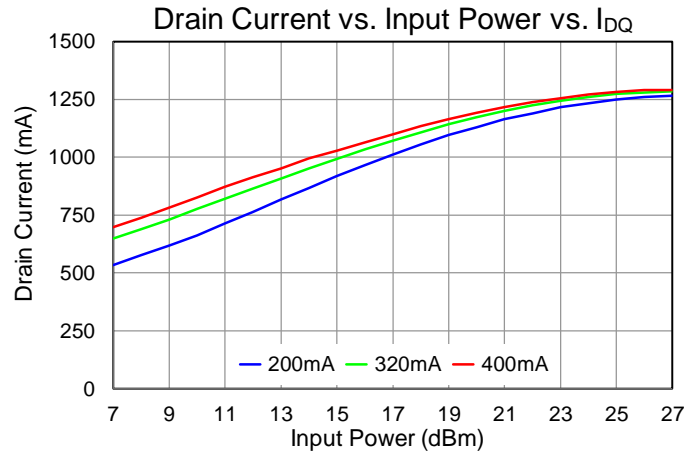
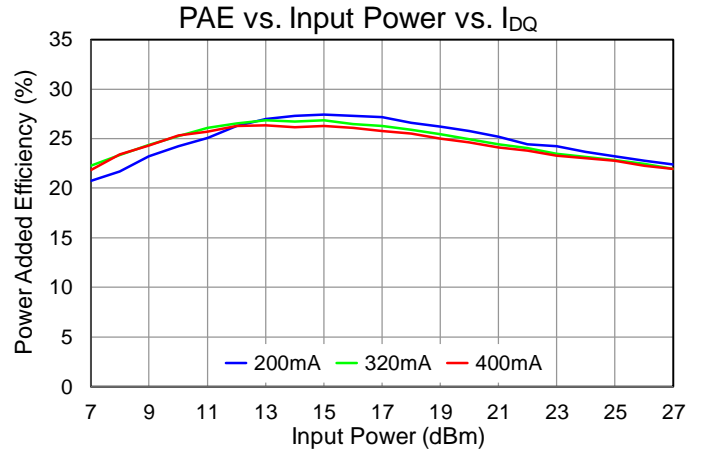
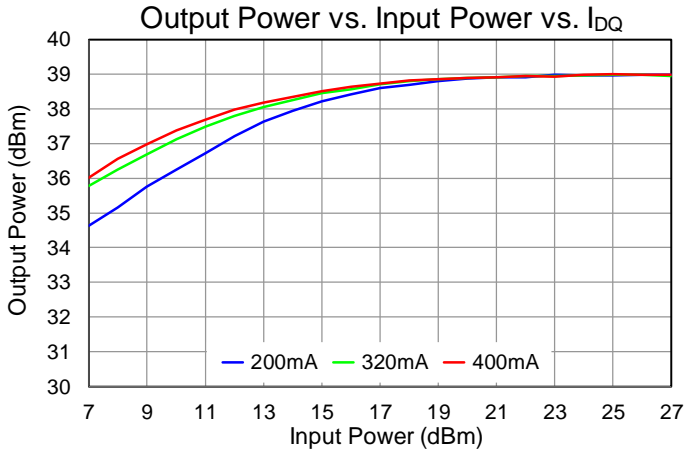

Performance Plots – Large Signal (CW)

Test conditions, unless otherwise noted: $V_D=24\text{ V}$, $I_{DQ}=320\text{ mA}$, $T=+25\text{ }^\circ\text{C}$, $P_{IN}=21\text{ dBm}$

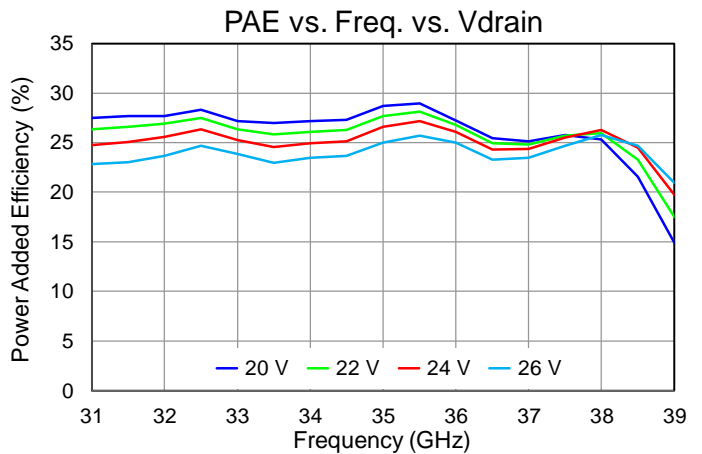
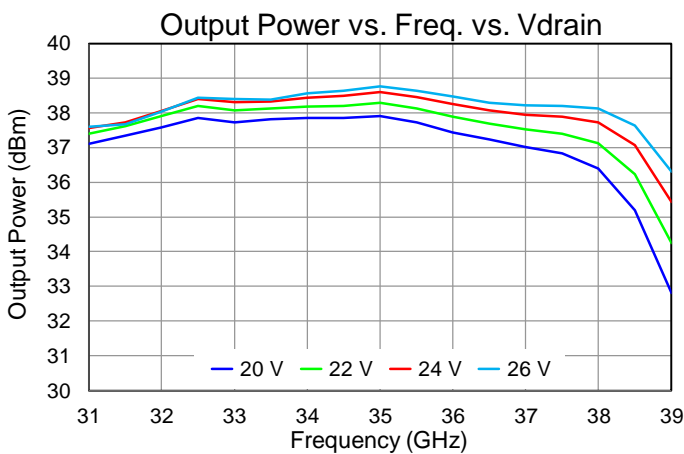
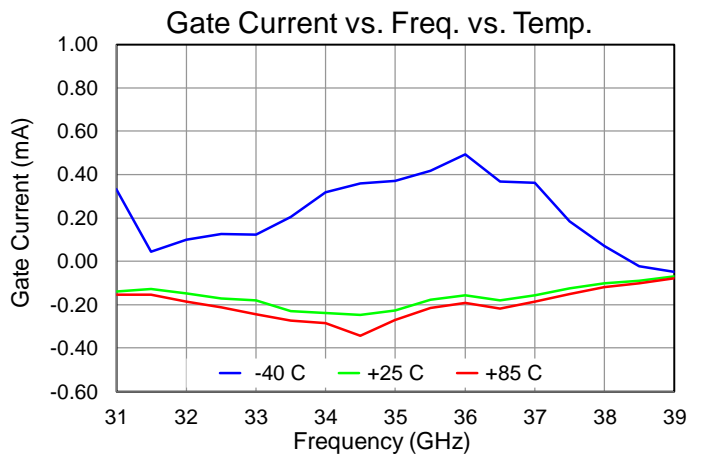
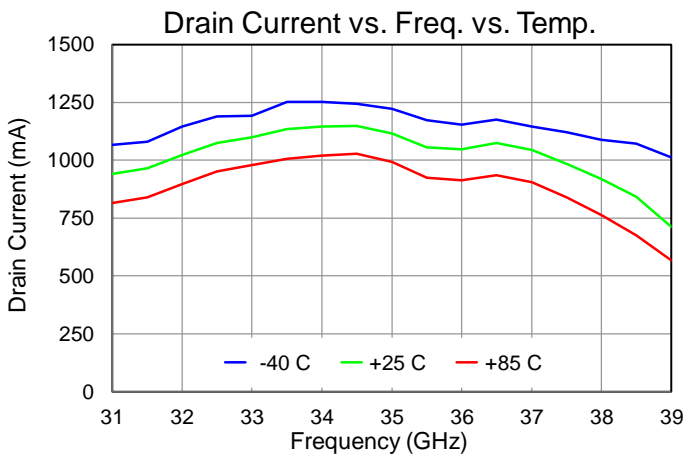
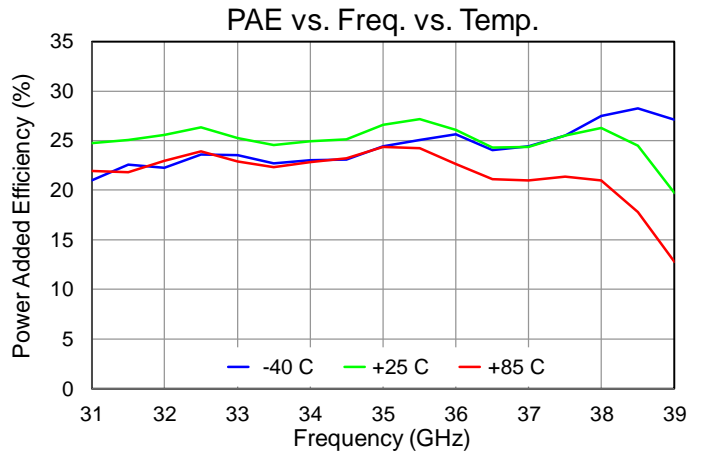
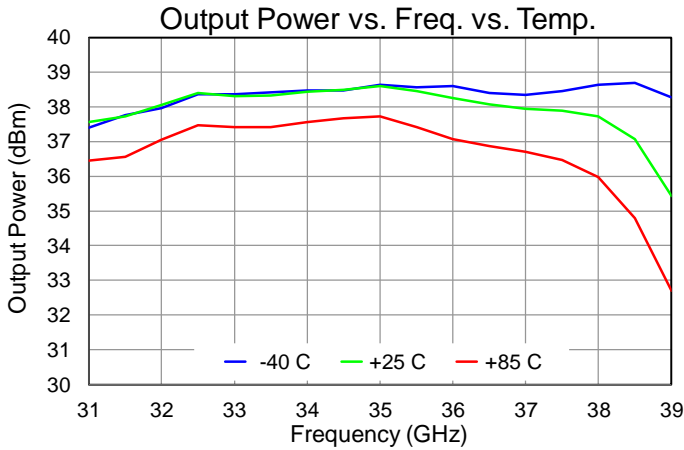

Performance Plots – Large Signal (CW)

Test conditions, unless otherwise noted: $V_D=24\text{ V}$, $I_{DQ}=320\text{ mA}$, $T=+25\text{ }^\circ\text{C}$, $P_{IN}=21\text{ dBm}$

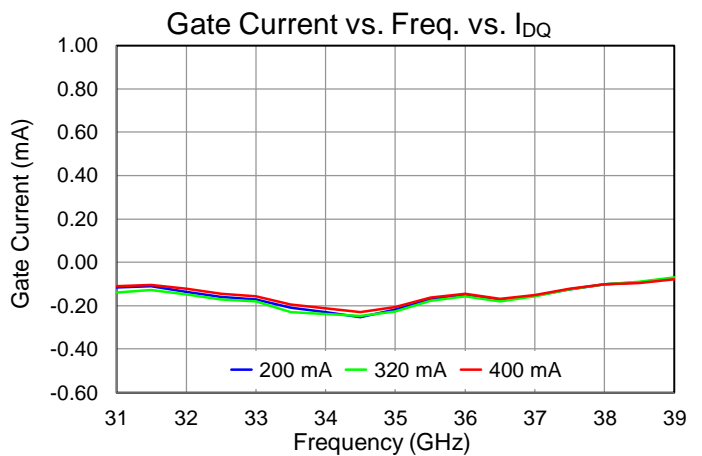
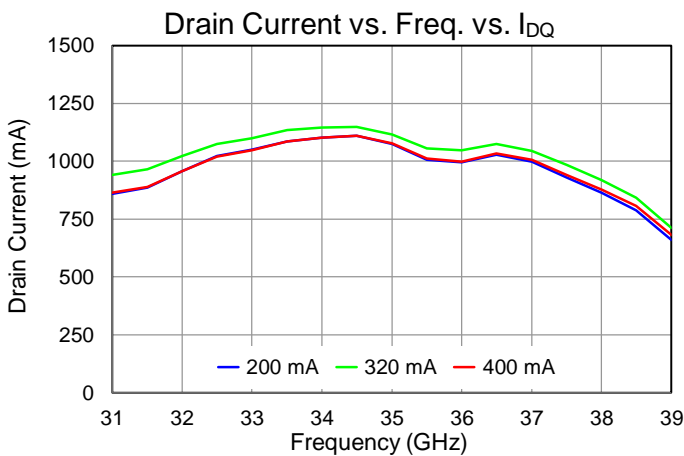
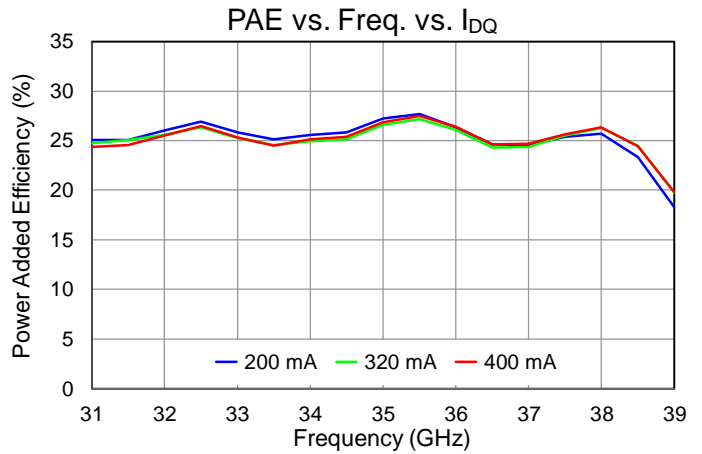
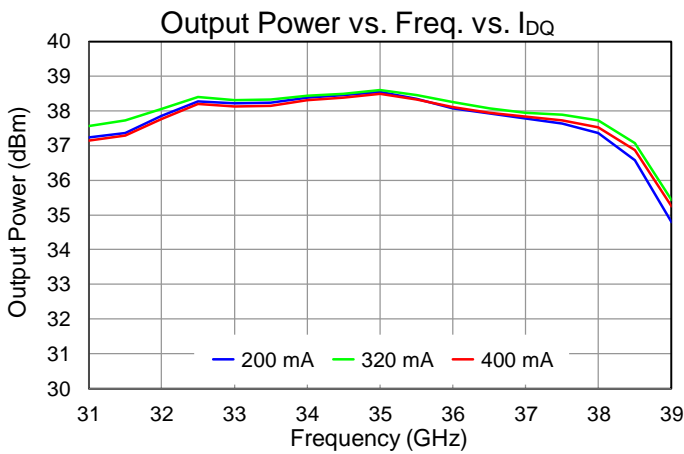
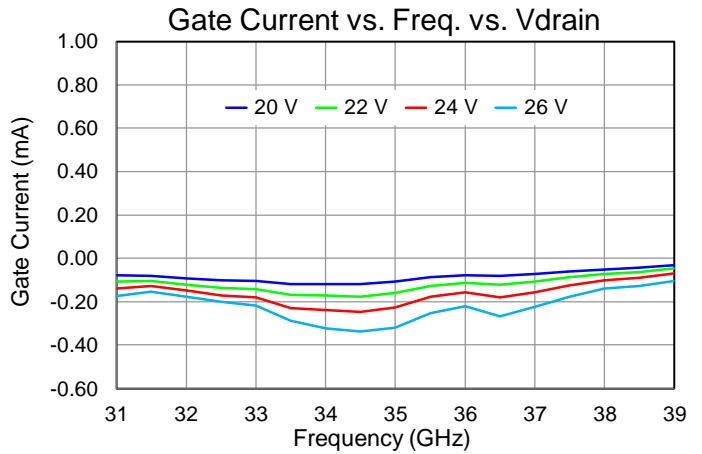
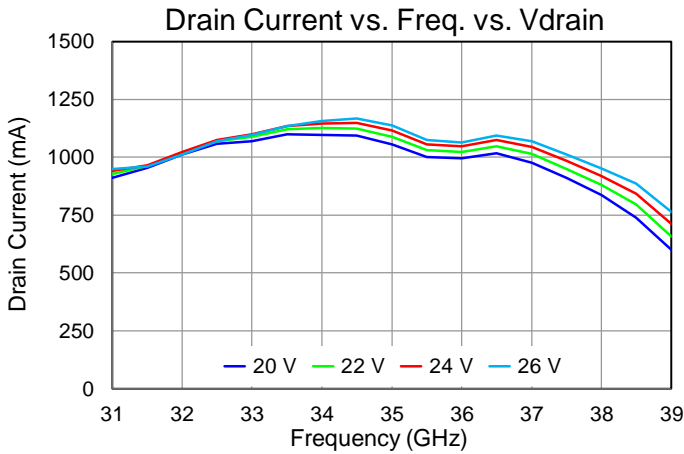

Performance Plots – Large Signal (CW)

Test conditions, unless otherwise noted: $V_D=24\text{ V}$, $I_{DQ}=320\text{ mA}$, $T=+25\text{ }^\circ\text{C}$

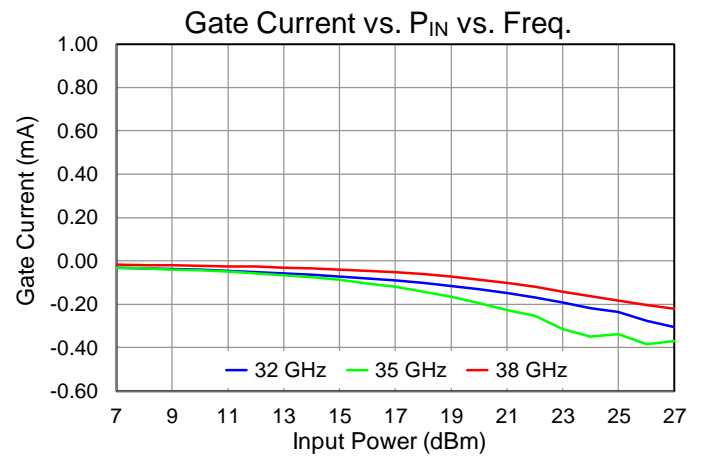
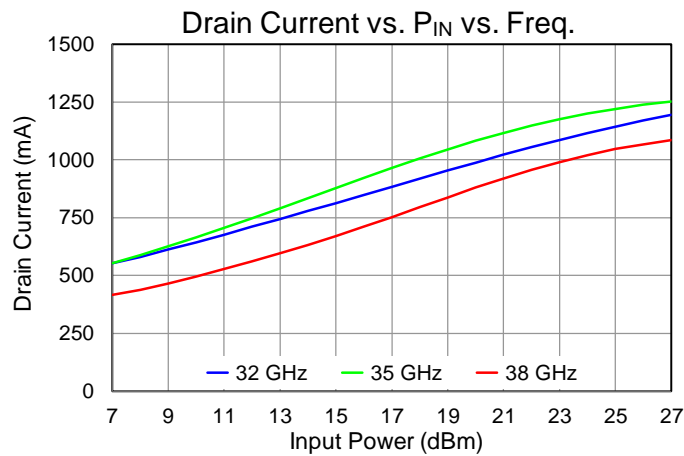
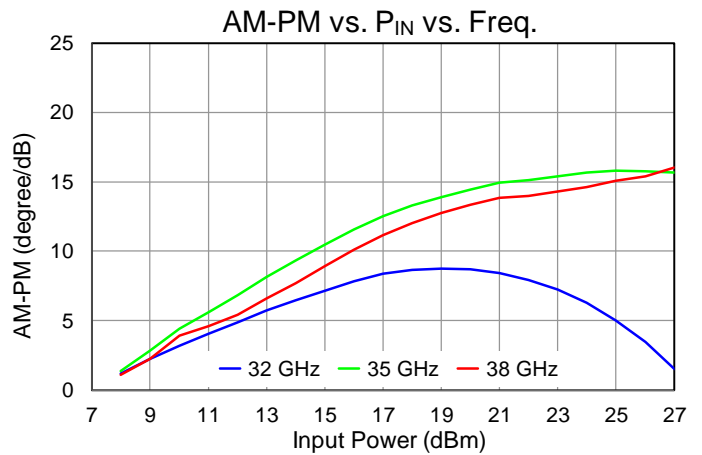
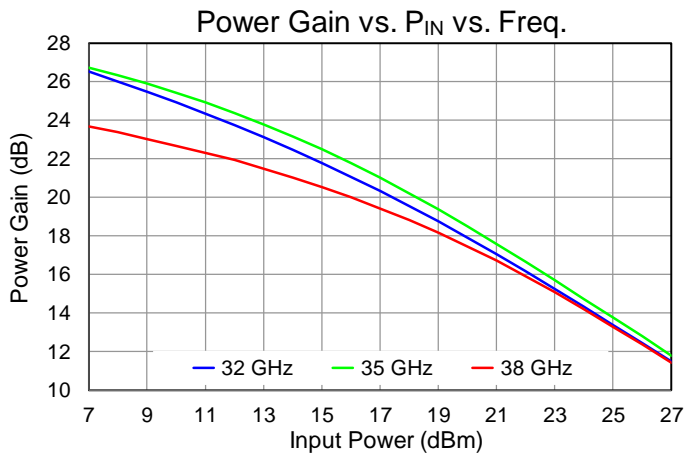
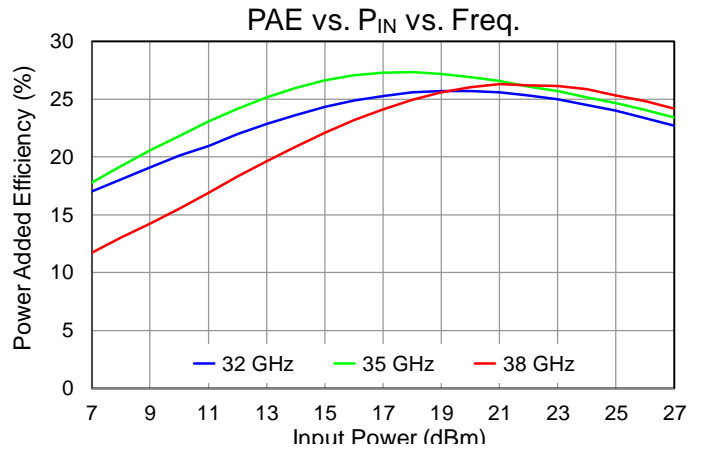
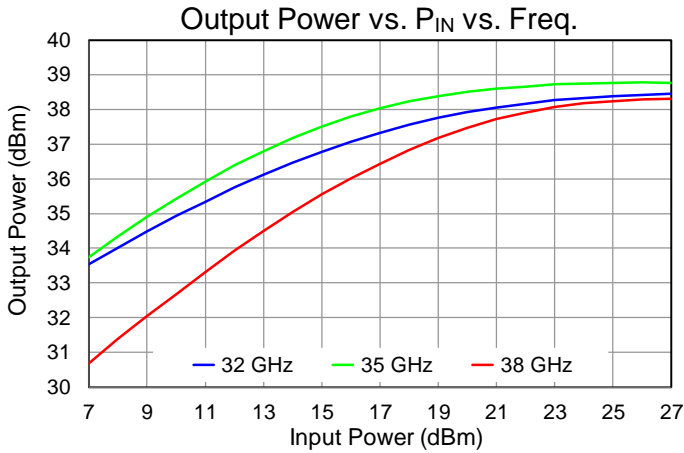

Performance Plots – Large Signal (CW)

Test conditions, unless otherwise noted: $V_D=24\text{ V}$, $I_{DQ}=320\text{ mA}$, $T=+25\text{ }^\circ\text{C}$, Freq. = 35 GHz

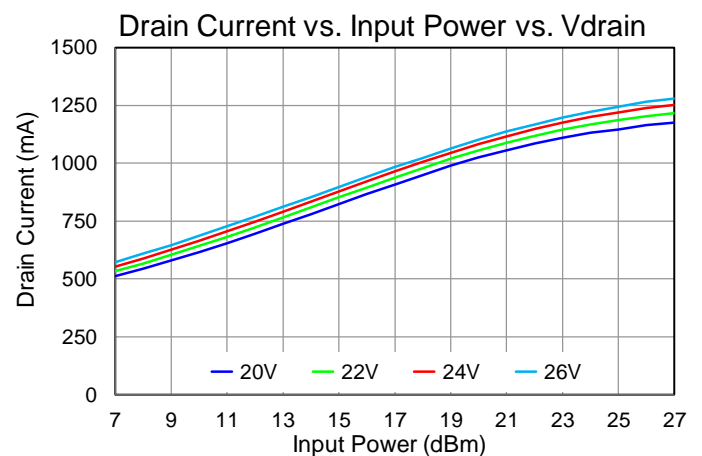
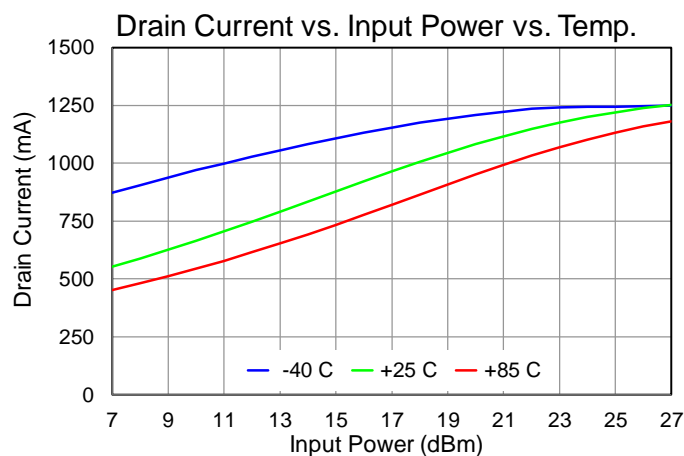
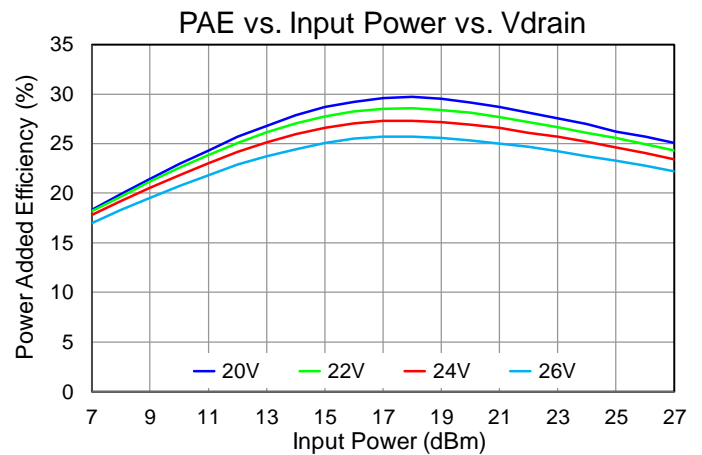
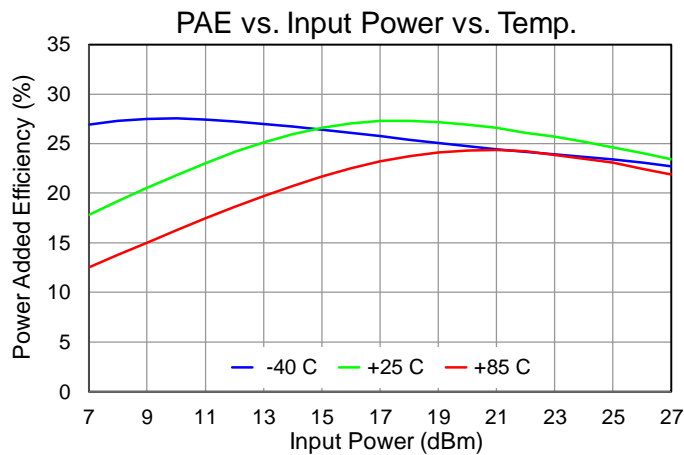
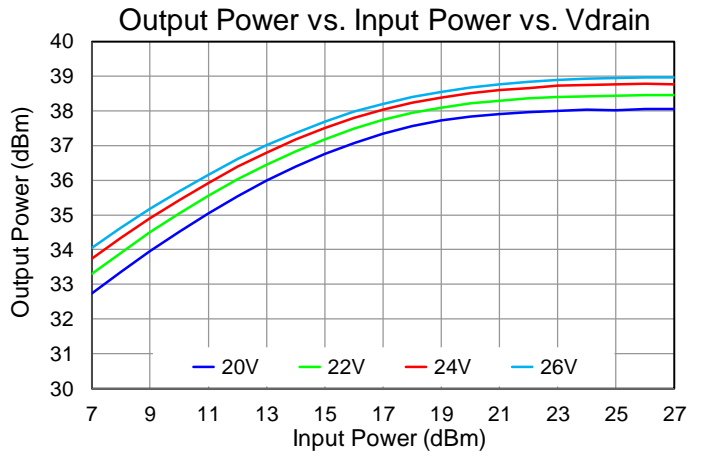
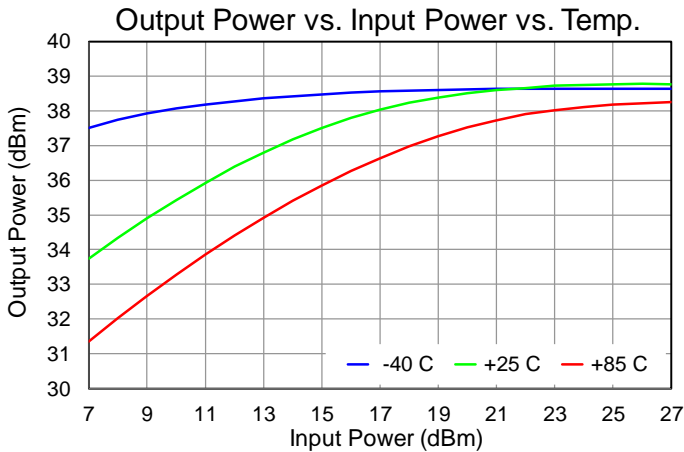

Performance Plots – Large Signal (CW)

Test conditions, unless otherwise noted: $V_D=24\text{ V}$, $I_{DQ}=320\text{ mA}$, $T=+25\text{ }^\circ\text{C}$, Freq. = 35 GHz

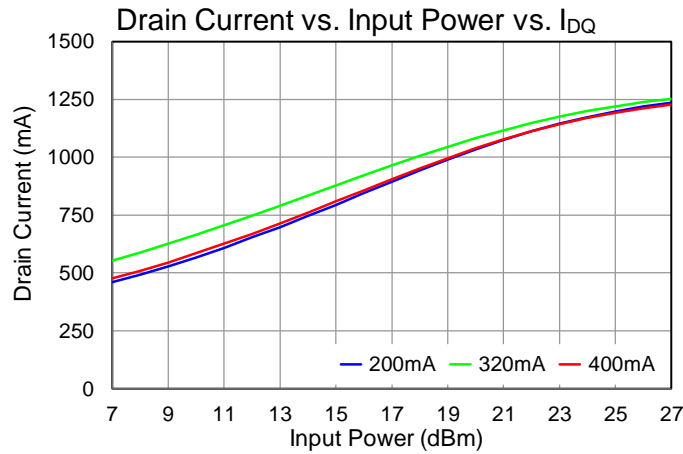
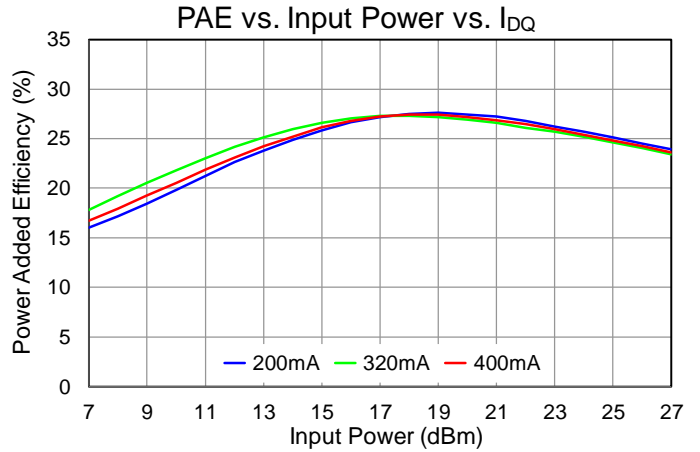
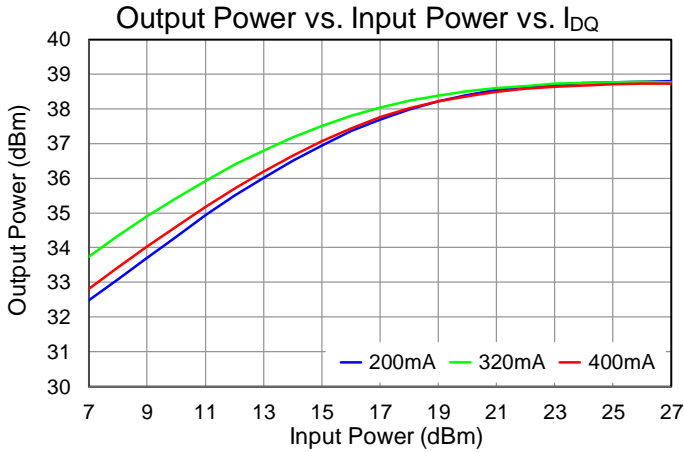

Performance Plots – Small Signal

Test conditions, unless otherwise noted: $V_D=24\text{ V}$, $I_{DQ}=320\text{ mA}$, $T=+25\text{ }^\circ\text{C}$

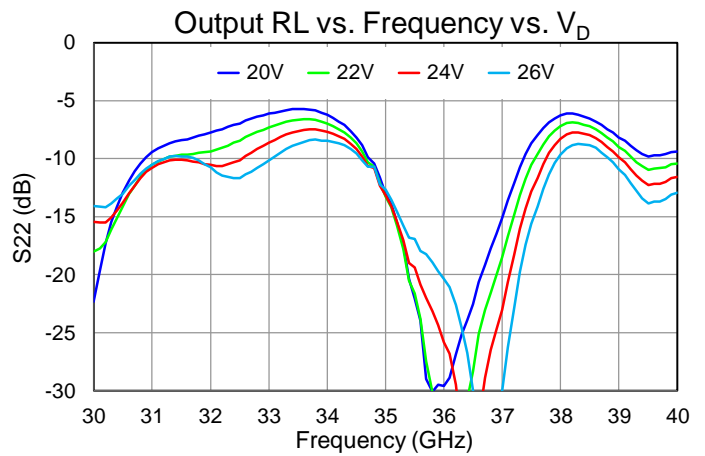
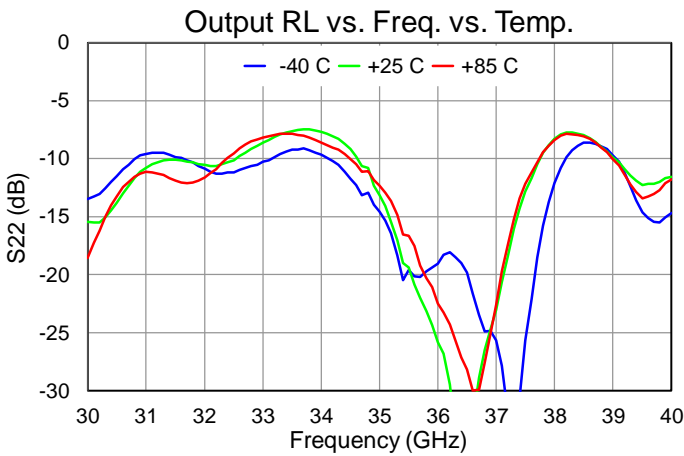
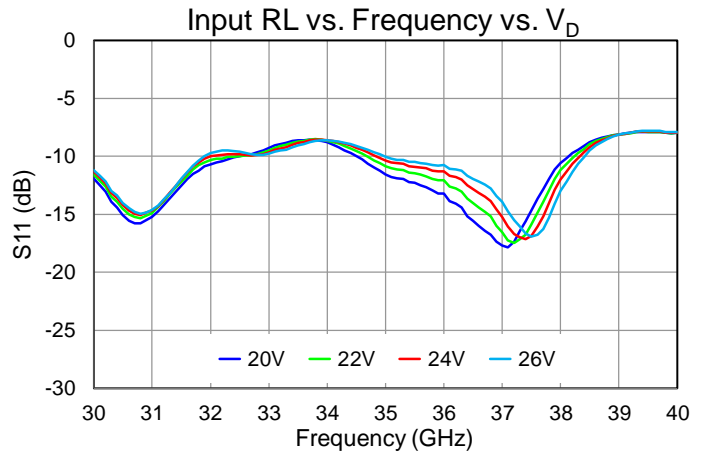
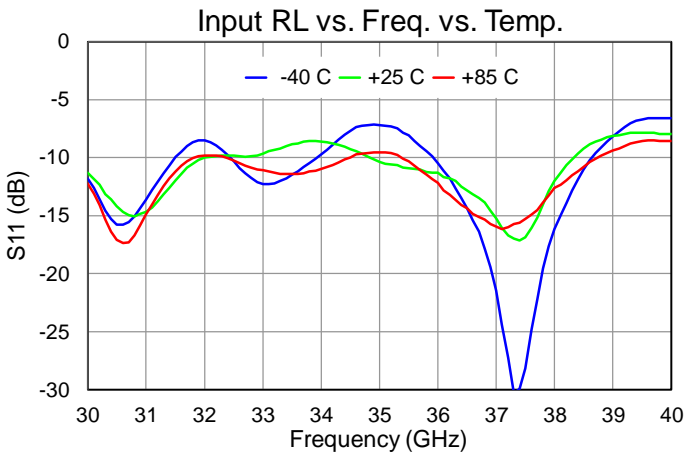
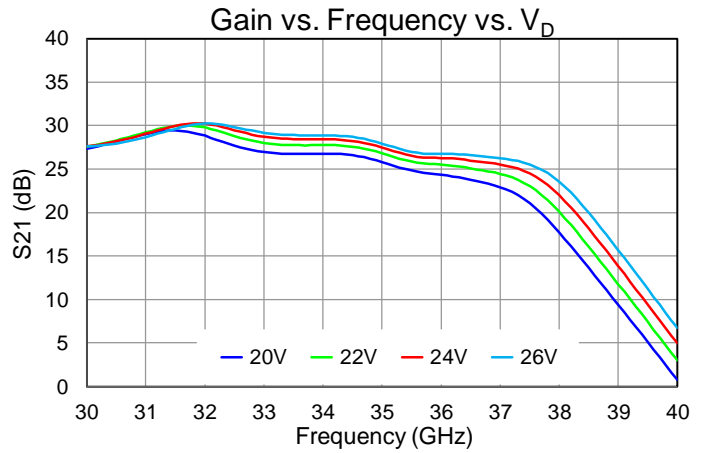
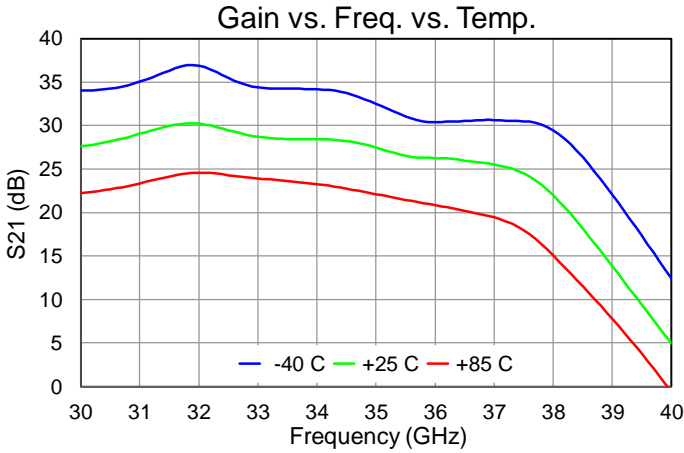

Performance Plots – Small Signal

Test conditions, unless otherwise noted: $V_D=24\text{ V}$, $I_{DQ}=320\text{ mA}$, $T=+25\text{ }^\circ\text{C}$

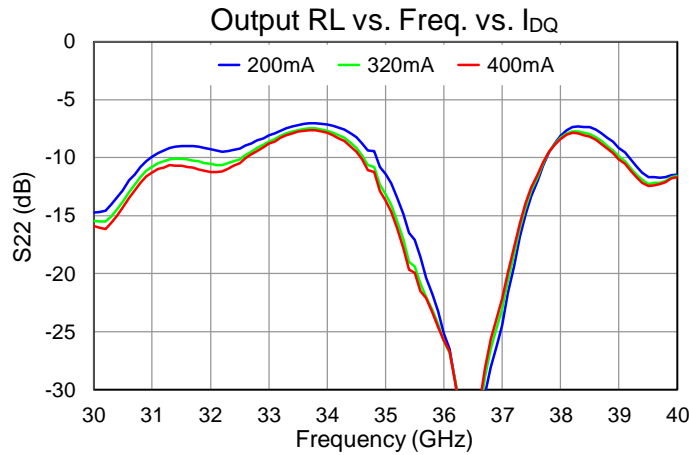
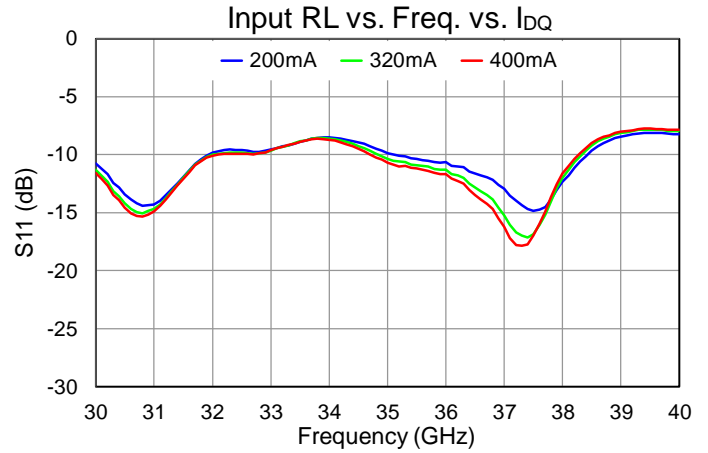
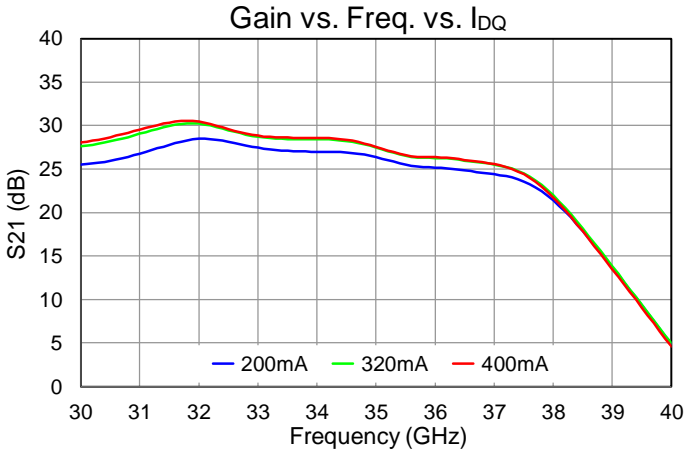

Thermal and Reliability Information

Parameter	Test Conditions	Value	Units
Thermal Resistance (θ_{JC}) ⁽¹⁾	$T_{base} = 85\text{ }^\circ\text{C}$, $V_D = 26\text{ V}$, $I_{DQ} = 320\text{ mA}$, $P_{DISS} = 8.32\text{ W}$, No RF (quiescent DC operation)	4.88	$^\circ\text{C/W}$
Channel Temperature, T_{CH} ⁽²⁾		126	$^\circ\text{C}$
Thermal Resistance (θ_{JC}) ⁽¹⁾	$T_{base} = 85\text{ }^\circ\text{C}$, $V_D = 26\text{ V}$, $I_{DQ} = 320\text{ mA}$, Freq = 33.5 GHz, $I_{D_Drive} = 1.151\text{ A}$, $P_{IN} = 21\text{ dBm}$, $P_{OUT} = 38.5\text{ dBm}$, $P_{DISS} = 23.15\text{ W}$ (Pulsed; 100us/10%)	4.05	$^\circ\text{C/W}$
Channel Temperature, T_{CH} (Under RF) ⁽²⁾		179	$^\circ\text{C}$
Thermal Resistance (θ_{JC}) ⁽¹⁾	$T_{base} = 85\text{ }^\circ\text{C}$, $V_D = 24\text{ V}$, $I_{DQ} = 320\text{ mA}$, Freq = 34.0 GHz, $I_{D_Drive} = 1.019\text{ A}$, $P_{IN} = 21\text{ dBm}$, $P_{OUT} = 37.6\text{ dBm}$, $P_{DISS} = 18.88\text{ W}$ (CW)	5.54	$^\circ\text{C/W}$
Channel Temperature, T_{CH} (Under RF) ⁽²⁾		190	$^\circ\text{C}$

Notes:

- Thermal resistance determined to the back of a 20 mil Cu-Mo carrier plate with eutectic die attach (85 $^\circ\text{C}$)
- Refer to the following document: [GaN Device Channel Temperature, Thermal Resistance, and Reliability Estimates](#)

Dissipated Power and Maximum Gate Current

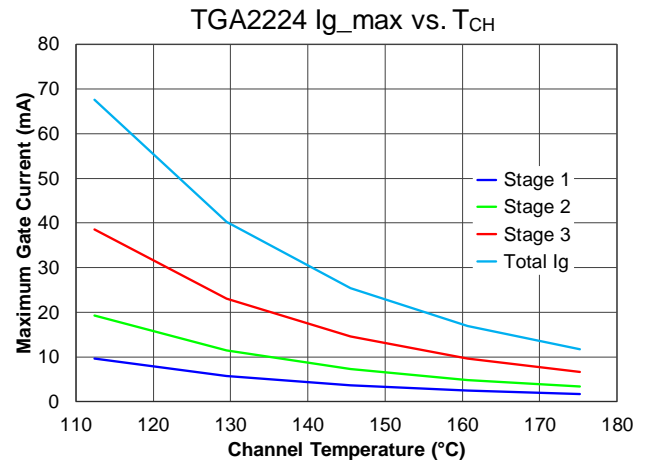
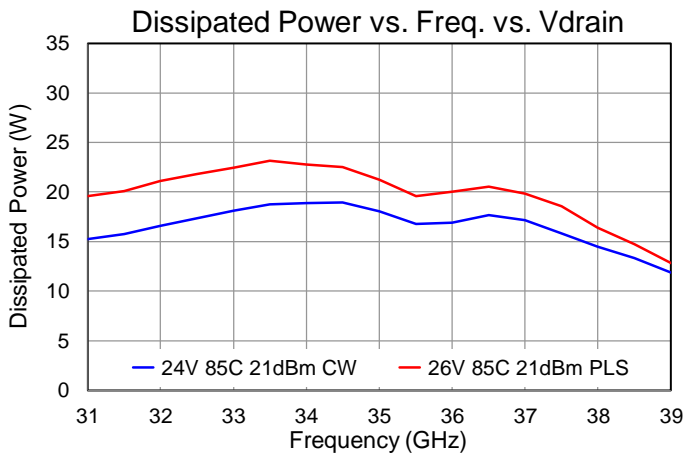

Test conditions, unless otherwise noted: $I_{DQ} = 320\text{ mA}$, $T = +85\text{ }^\circ\text{C}$, $P_{in} = 21\text{ dBm}$

Applications Information

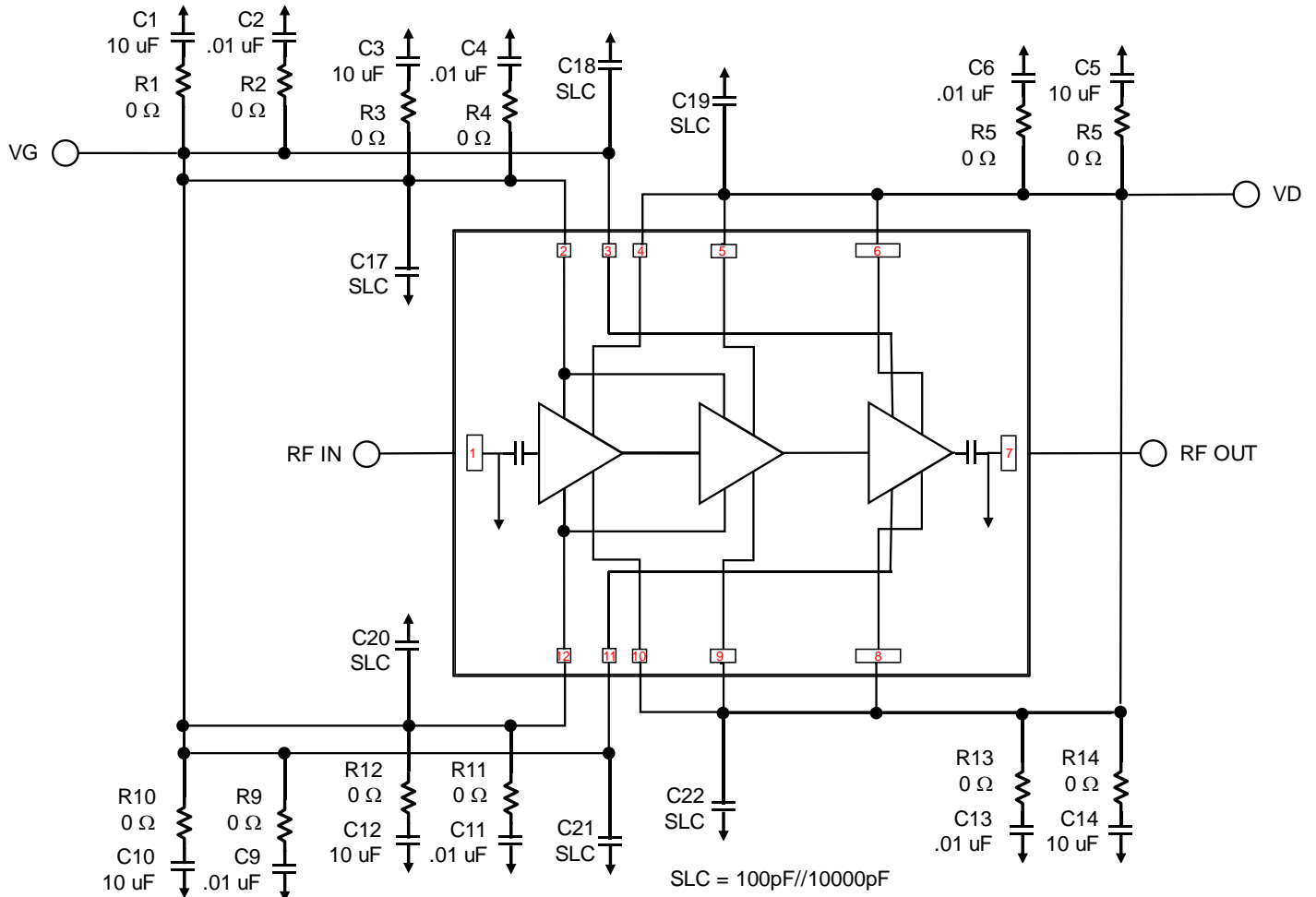

Note: V_G and V_D must be biased from both sides.
Remove C5 and C14 for pulsed operation.

Bias-Up Procedure

1. Set I_D limit to 2700 mA, I_G limit to 5 mA
2. Set V_G to -4.0 V
3. Set V_D +26 V (pulsed) or +24 V (CW)
4. Adjust V_G more positive until $I_{DQ} \approx 320$ mA
5. Apply RF signal

Bias-Down Procedure

1. Turn off RF signal
2. Reduce V_G to -4.0 V. Ensure $I_{DQ} \sim 0$ mA
4. Set V_D to 0 V
5. Turn off V_D supply
6. Turn off V_G supply

Evaluation Board (EVB) Layout Assembly

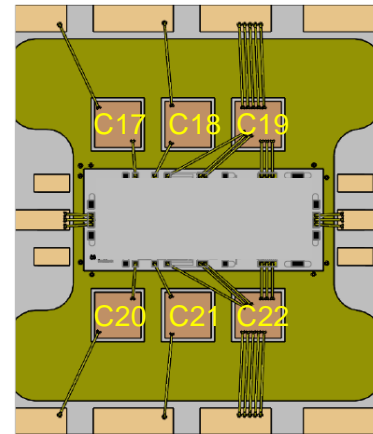
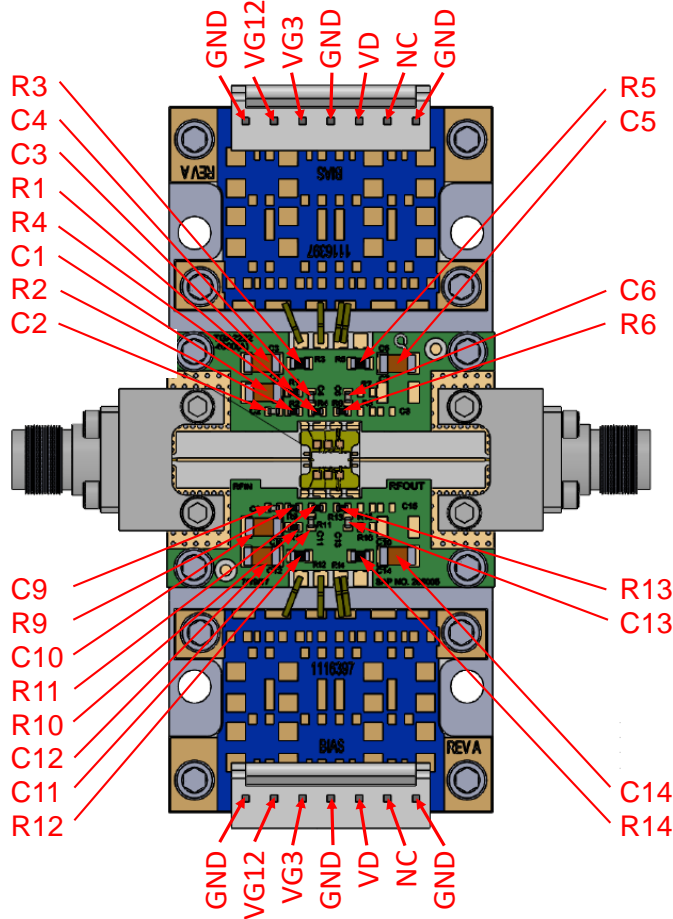

Die Bonding Detail

PCB is made from Rogers RO6202 dielectric, .005 inch thick, 0.5 oz. copper both sides.

Bill of Materials

Reference Des.	Value	Description	Manuf.	Part Number
C1,C3,C5,C10,C12,C14	10 uF	CAP, 10uF, 20%, 50V, 20%, X5R, 1206	Various	
C2,C4,C6,C9,C11,C13	0.01 uF	CAP, 0.01uF, 10%, 50V, X7R, 0402	Various	
C17,C18,C19,C20,C21,C22	10K//100pF	CAP, 10K//100pF, ±20%, 50V, X7R, 30X30,SL	Presidio Components	MVB3030X103M2H5C1F
R1,R2,R4,R6,R9,R10,R11,R13	0 Ω	RES, 0 OHM, JMPR, 0402	Various	
R3,R5,R12,R14	0 Ω	RES, 0 OHM, 1/10 W, 0603	Various	
J1, J2	2.4 mm	CONNECTOR, FEMALE, ENDLAUNCH	Southwest Microwave	1492-04A-5

Mechanical Information

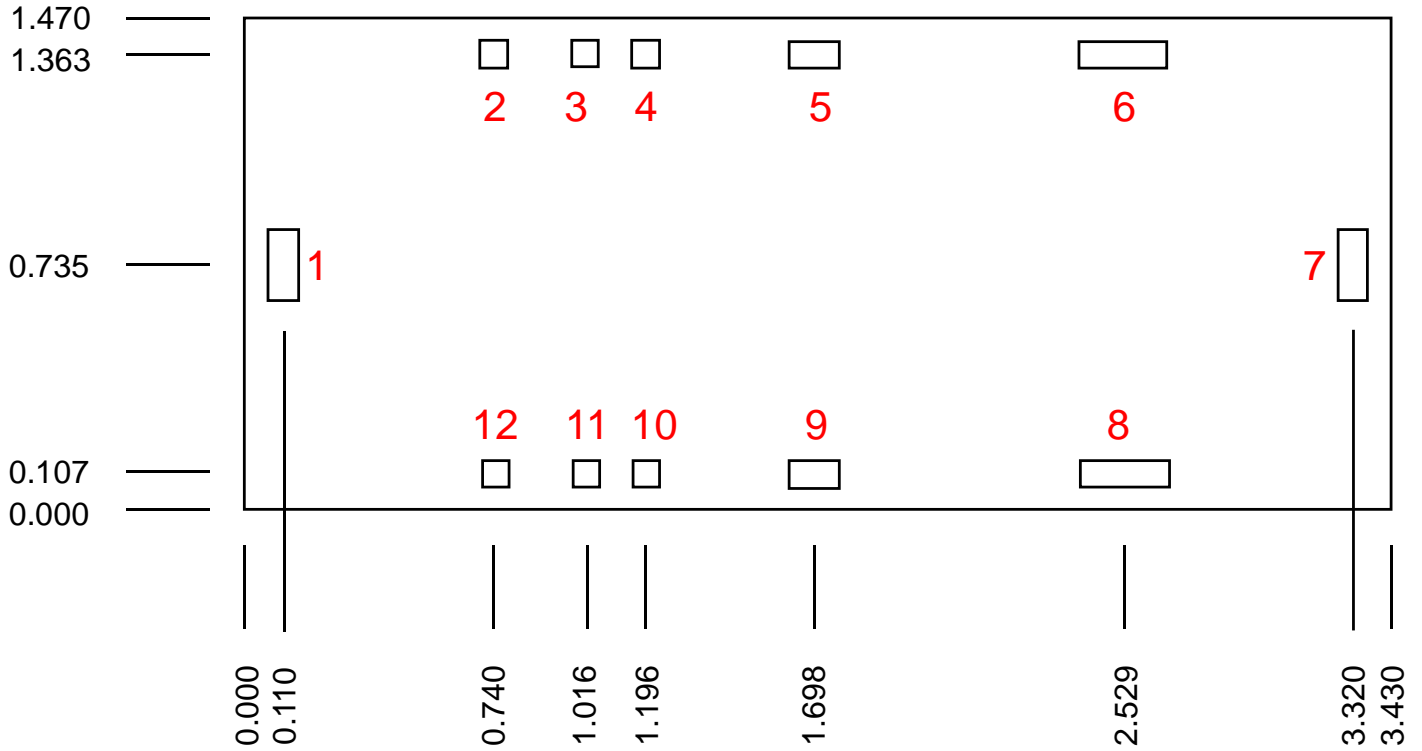

Dimensions are in mm
Thickness: 0.050
Die x, y size tolerance: ± 0.050
Ground is backside of die

Bond Pad Description

Pad No.	Symbol	Size (um x um)	Description
1	RF IN	90 x 208	RF input. 50 Ohms. DC shorted to ground.
2, 12	VG12	83 x 83	Gate voltage, stages 1 - 2. Bypass network required; refer to page 16.
3, 11	VG3	83 x 83	Gate voltage, stage 3. Bypass network required; refer to page 16.
4, 10	VD1	83 x 83	Drain voltage, stage 1. Bypass network required; refer to page 16.
5, 9	VD2	150 x 83	Drain voltage, stage 2. Bypass network required; refer to page 16.
6, 8	VD3	265 x 84	Drain voltage, stage 3. Bypass network required; refer to page 16.
7	RF OUT	90 x 208	RF output. 50 Ohms. DC shorted to ground.

Assembly Notes

Component placement and adhesive attachment assembly notes:

- Vacuum pencils and/or vacuum collets are the preferred method of pick up.
- Air bridges must be avoided during placement.
- The force impact is critical during auto placement.

Reflow process assembly notes:

- Use AuSn (80/20) solder and limit exposure to temperatures above 300 °C for 30 seconds, maximum.
- An alloy station or conveyor furnace with reducing atmosphere should be used.
- Do not use any kind of flux.
- Coefficient of thermal expansion matching is critical for long-term reliability.
- Devices must be stored in a dry nitrogen atmosphere.

Interconnect process assembly notes:

- Thermosonic ball bonding is the preferred interconnect technique.
- Force, time, and ultrasonic are critical parameters.
- Aluminum wire should not be used.
- Devices with small pad sizes should be bonded with 0.0007-inch wire.