

Product Overview

The Qorvo TGF2819-FS is a greater-than 200 W (P_{3dB}) discrete GaN on SiC HEMT which operates from DC to 4 GHz. The device is in an industry standard air cavity package and is ideally suited for IFF, avionics, military and civilian radar, and test instrumentation. The device can support pulsed and linear operations.

Lead-free and ROHS compliant

Evaluation boards are available upon request.



NI-360 Package

Functional Block Diagram

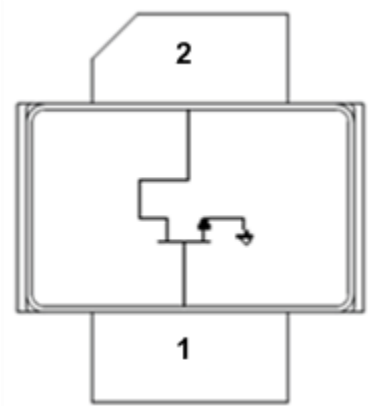

Key Features

- Frequency: DC to 4 GHz
 - Output Power (P_{3dB})¹: 257 W
 - Linear Gain¹: 18 dB
 - Typical PAE_{3dB}¹: 67.5%
 - Operating Voltage: 50 V
 - CW and Pulse capable
- Note 1: @ 3 GHz Load Pull

Applications

- Military and civilian radar
- Professional and military radio communications
- Test instrumentation
- Wideband or narrowband amplifiers
- Jammers

Ordering info

Part No.	ECCN	Description
TGF2819-FS	3A001.b.3.a	DC–4 GHz, 50 V, 200 W GaN RF Transistor
TGF2819-FSPCB4B01	EAR99	3.1 – 3.5 GHz EVB
TGF2819-FSEVB03	EAR99	1.35 – 1.75 GHz EVB

Absolute Maximum Ratings¹

Parameter	Rating	Units
Breakdown Voltage, BV_{DG}	+145	V
Gate Voltage Range, V_G	-7 to +2.0	V
Drain Current, $I_{D_{MAX}}$	12	A
Gate Current Range, I_G	See page 20.	mA
Power Dissipation, P_{DISS}	207 ²	W
RF Input Power, $T = 25\text{ }^\circ\text{C}^2$	+39.8	dBm
Channel Temperature, T_{CH}	275	$^\circ\text{C}$
Mounting Temperature (30 Seconds)	320	$^\circ\text{C}$
Storage Temperature	-65 to +150	$^\circ\text{C}$

Notes:

1. Operation of this device outside the parameter ranges given above may cause permanent damage.
2. Pulsed 100uS PW, 20% DC

Recommended Operating Conditions¹

Parameter	Min	Typ	Max	Units
Operating Temp. Range	-40	+25	+85	$^\circ\text{C}$
Drain Voltage Range, V_D	+32	+50	+55	V
Drain Bias Current, I_{DQ}		250		mA
Drain Current, I_D^4	-	7.2	-	A
Gate Voltage, V_G^3	-	-2.8	-	V
Channel Temperature (T_{CH})	-	-	250	$^\circ\text{C}$
Power Dissipation (P_D) ^{2,4}	-	-	184	W
Power Dissipation (P_D), CW ²	-	-	98	W

Notes:

1. Electrical performance is measured under conditions noted in the electrical specifications table. Specifications are not guaranteed over all recommended operating conditions.
2. Package base at 85 $^\circ\text{C}$
3. To be adjusted to desired I_{DQ}
4. Pulsed, 100uS PW, 20% DC

Measured Load Pull Performance – Power Tuned¹

Parameter	Typical Values						Units
	2.7	2.9	3.1	3.3	3.5	3.7	
Frequency, F	2.7	2.9	3.1	3.3	3.5	3.7	GHz
Drain Voltage, V_D	50	50	50	50	50	50	V
Drain Bias Current, I_{DQ}	200	200	200	200	200	200	mA
Output Power at 3dB compression, P_{3dB}	54	53.5	53.2	53	53	52.7	dBm
Power Added Efficiency at 3dB compression, PAE_{3dB}	60.0	53.7	46.0	48.8	43	51.4	%
Gain at 3dB compression, G_{3dB}	13.9	14.3	13.3	16.5	14	15.5	dB

Notes:

1. Pulsed, 100 uS Pulse Width, 20% Duty Cycle
2. Characteristic Impedance, $Z_o = 7\ \Omega$.

Measured Load Pull Performance – Efficiency Tuned¹

Parameter	Typical Values						Units
	2.7	2.9	3.1	3.3	3.5	3.7	
Frequency, F	2.7	2.9	3.1	3.3	3.5	3.7	GHz
Drain Voltage, V_D	50	50	50	50	50	50	V
Drain Bias Current, I_{DQ}	200	200	200	200	200	200	mA
Output Power at 3dB compression, P_{3dB}	52.5	53.2	52.6	52.1	52.3	51.9	dBm
Power Added Efficiency at 3dB compression, PAE_{3dB}	65.5	64.3	54.4	52.2	53.7	53.9	%
Gain at 3dB compression, G_{3dB}	15.8	15.5	15.5	17.8	16.1	15.9	dB

Notes:

1. Pulsed, 100 uS Pulse Width, 20% Duty Cycle
2. Characteristic Impedance, $Z_o = 7\ \Omega$.

3.1 – 3.5 GHz EVB – 3.5 GHz Performance¹

Parameter	Min	Typ	Max	Units
Linear Gain, G_{LIN}	–	15.1	–	dB
Output Power at 3dB compression point, P3dB	–	126	–	W
Drain Efficiency at 3dB compression point, DEFF3dB	–	52.4	–	%
Gain at 3dB compression point, G3dB	–	12.1	–	dB
Gate Leakage ²	-31.7	–	–	mA

Notes:

1. $V_D = +32\text{ V}$, $I_{DQ} = 250\text{ mA}$, Temp = +25 °C, Pulse Width = 100 μs , Duty Cycle = 20%
2. $V_D = +10\text{ V}$, $V_G = -3.8\text{ V}$

RF Characterization – Mismatch Ruggedness at 3.5 GHz

Symbol	Parameter	dB Compression	Typical
VSWR	Impedance Mismatch Ruggedness	3	10:1

Test conditions unless otherwise noted: $T_A = 25\text{ °C}$, $V_D = 32\text{ V}$, $I_{DQ} = 250\text{ mA}$

Input drive power is determined at pulsed 3dB compression under matched condition at EVB output connector.

Measured Load-Pull Smith Charts^{1, 2}

Notes:

1. Test Conditions: $V_D = 50\text{ V}$, $I_{DQ} = 200\text{ mA}$, 100 μs Pulse Width, 20% Duty Cycle
2. See page 22 for load pull reference planes where the performance was measured.

2.7GHz, Load-pull

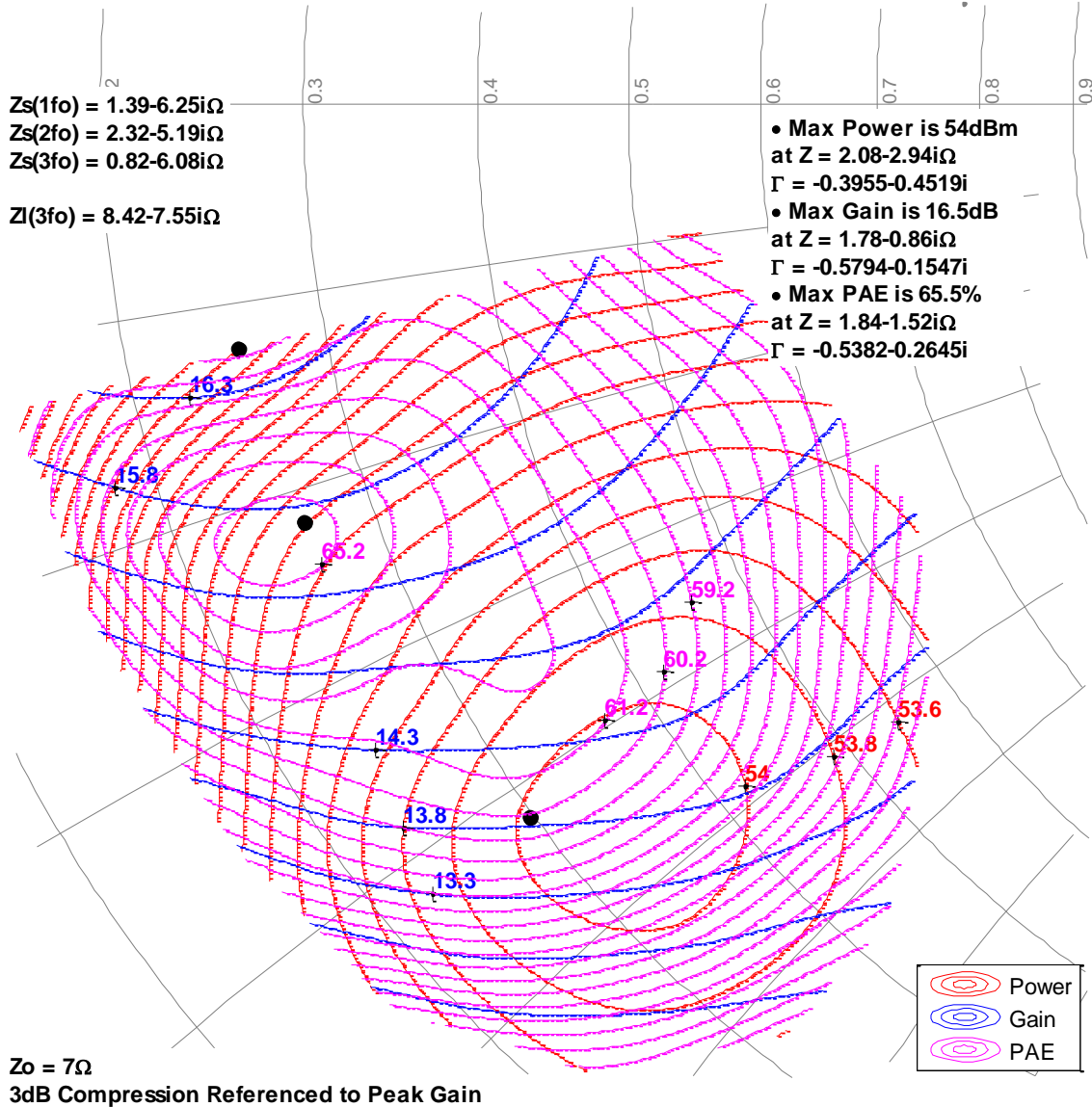

Measured Load-Pull Smith Charts^{1, 2}

Notes:

1. Test Conditions: $V_D = 50\text{ V}$, $I_{DQ} = 200\text{ mA}$, 100 uS Pulse Width, 20% Duty Cycle
2. See page 22 for load pull reference planes where the performance was measured.

2.9GHz, Load-pull

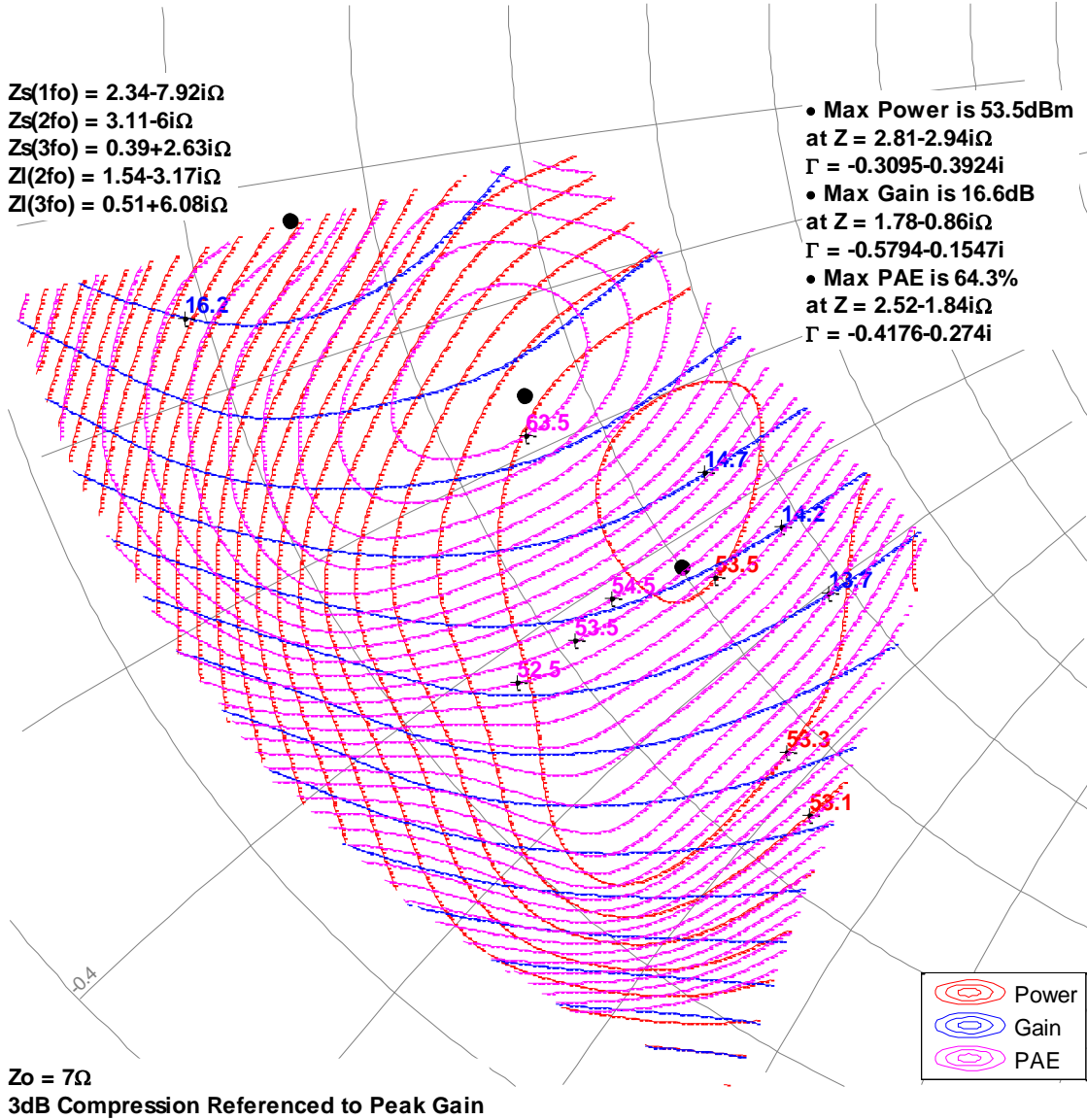

Measured Load-Pull Smith Charts^{1, 2}

Notes:

1. Test Conditions: $V_D = 50\text{ V}$, $I_{DQ} = 200\text{ mA}$, 100 μs Pulse Width, 20% Duty Cycle
2. See page 22 for load pull reference planes where the performance was measured.

3.1GHz, Load-pull

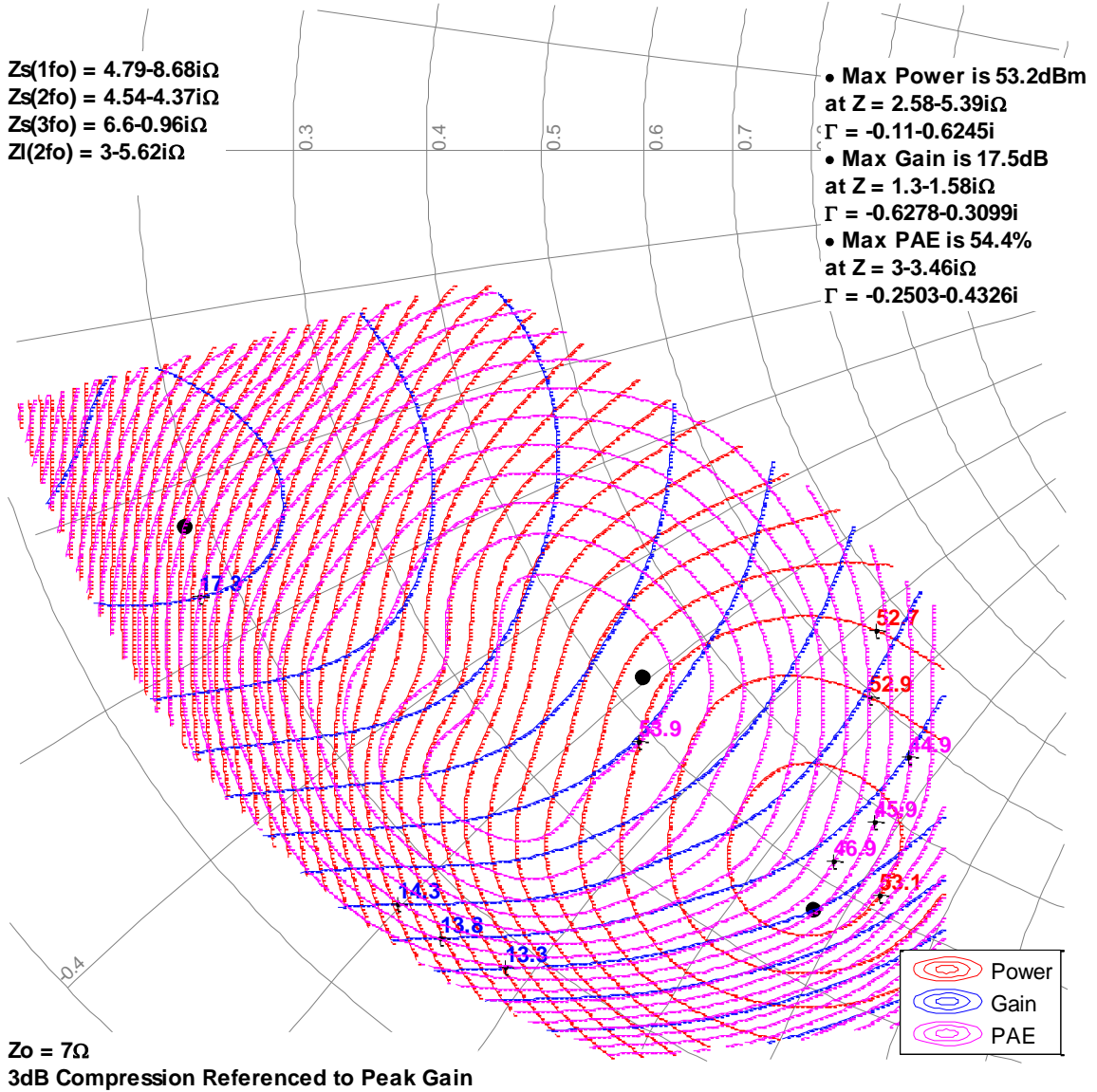

Measured Load-Pull Smith Charts^{1,2}

Notes:

1. Test Conditions: $V_D = 50\text{ V}$, $I_{DQ} = 200\text{ mA}$, 100 μs Pulse Width, 20% Duty Cycle
2. See page 22 for load pull reference planes where the performance was measured.

3.3GHz, Load-pull

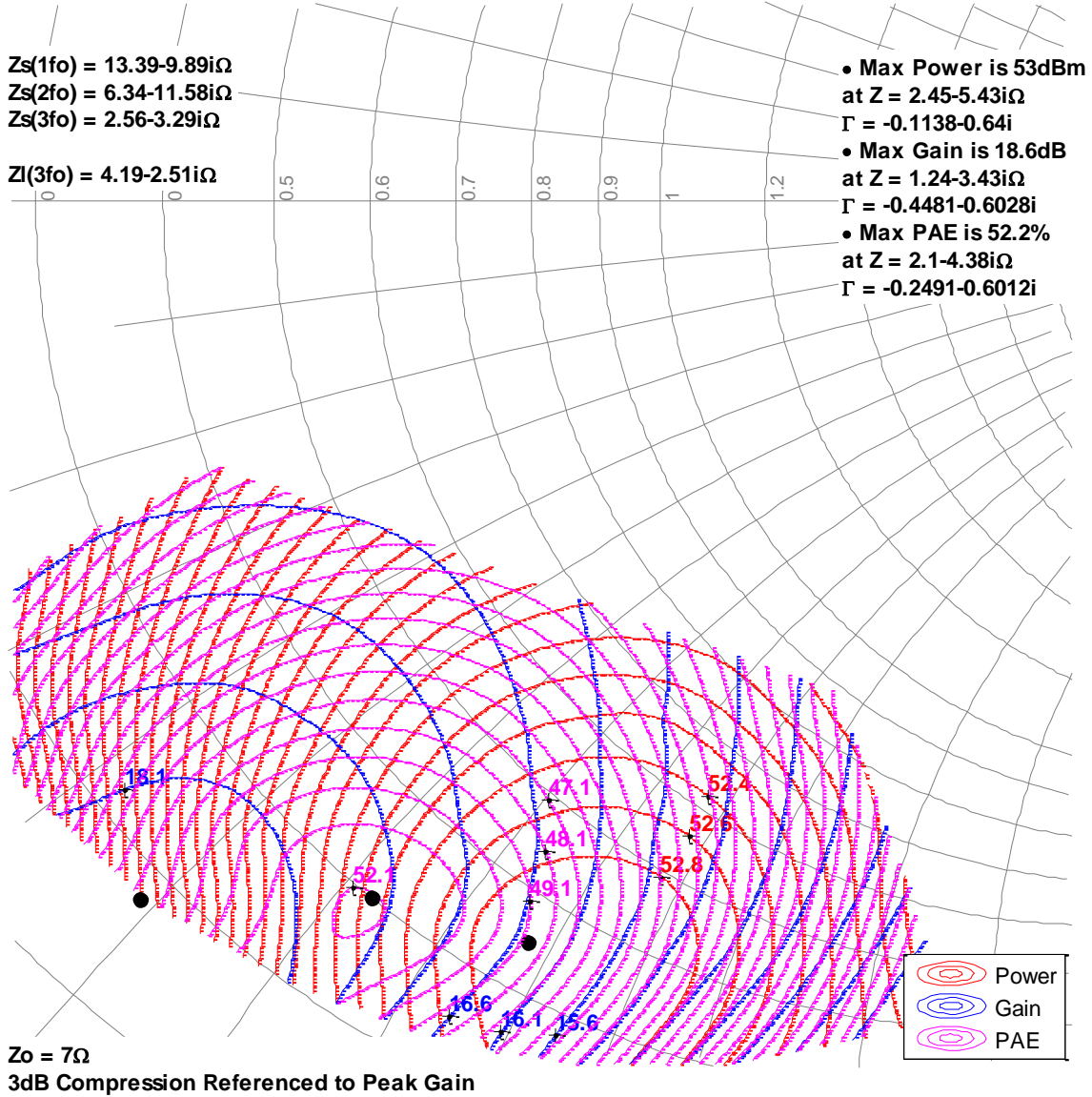

Measured Load-Pull Smith Charts^{1, 2}

Notes:

1. Test Conditions: $V_D = 50\text{ V}$, $I_{DQ} = 200\text{ mA}$, 100 μs Pulse Width, 20% Duty Cycle
2. See page 22 for load pull reference planes where the performance was measured.

3.5GHz, Load-pull

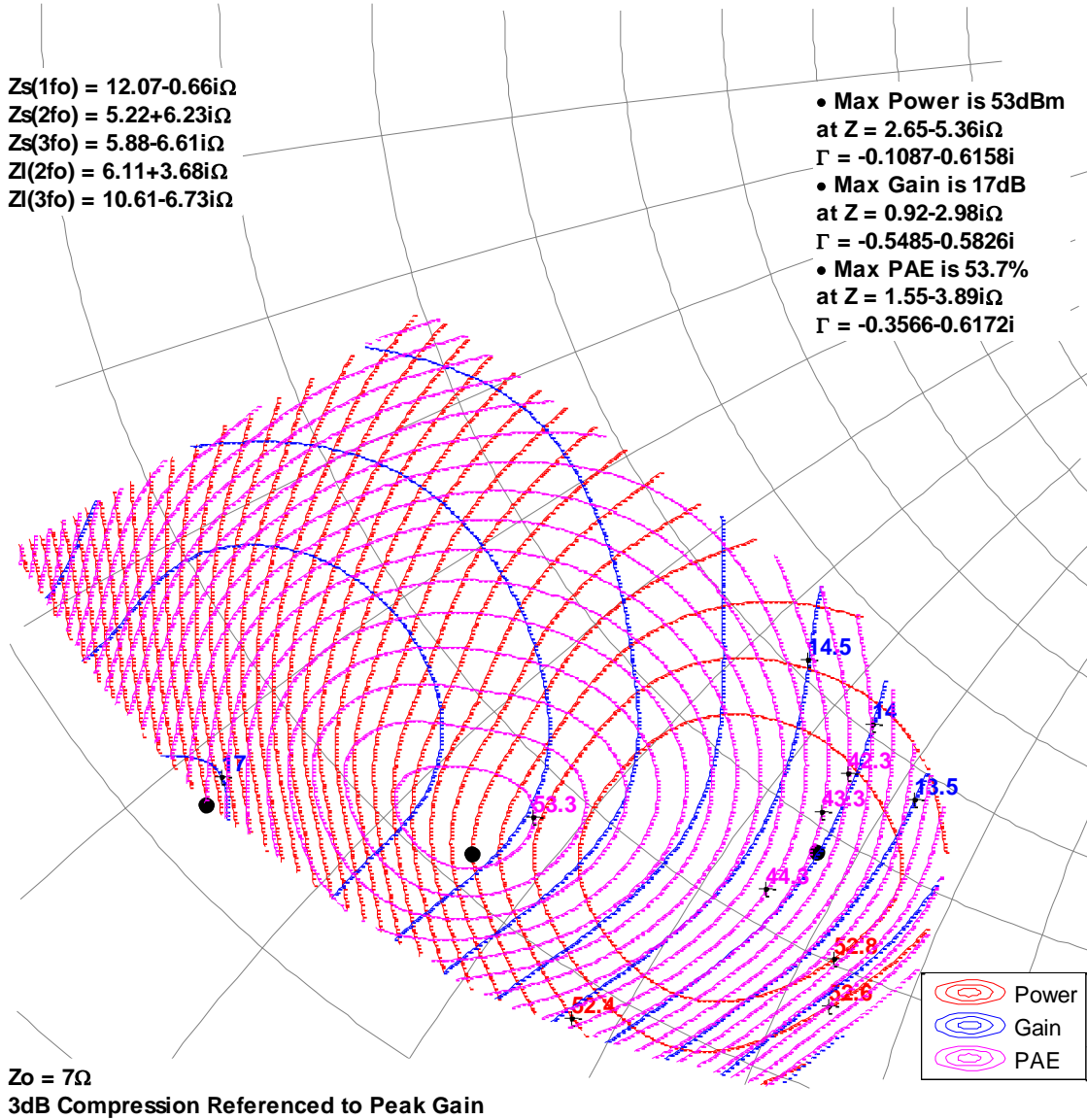

Measured Load-Pull Smith Charts^{1,2}

Notes:

1. Test Conditions: $V_D = 50\text{ V}$, $I_{DQ} = 200\text{ mA}$, 100 μs Pulse Width, 20% Duty Cycle
2. See page 22 for load pull reference planes where the performance was measured.

3.7GHz, Load-pull

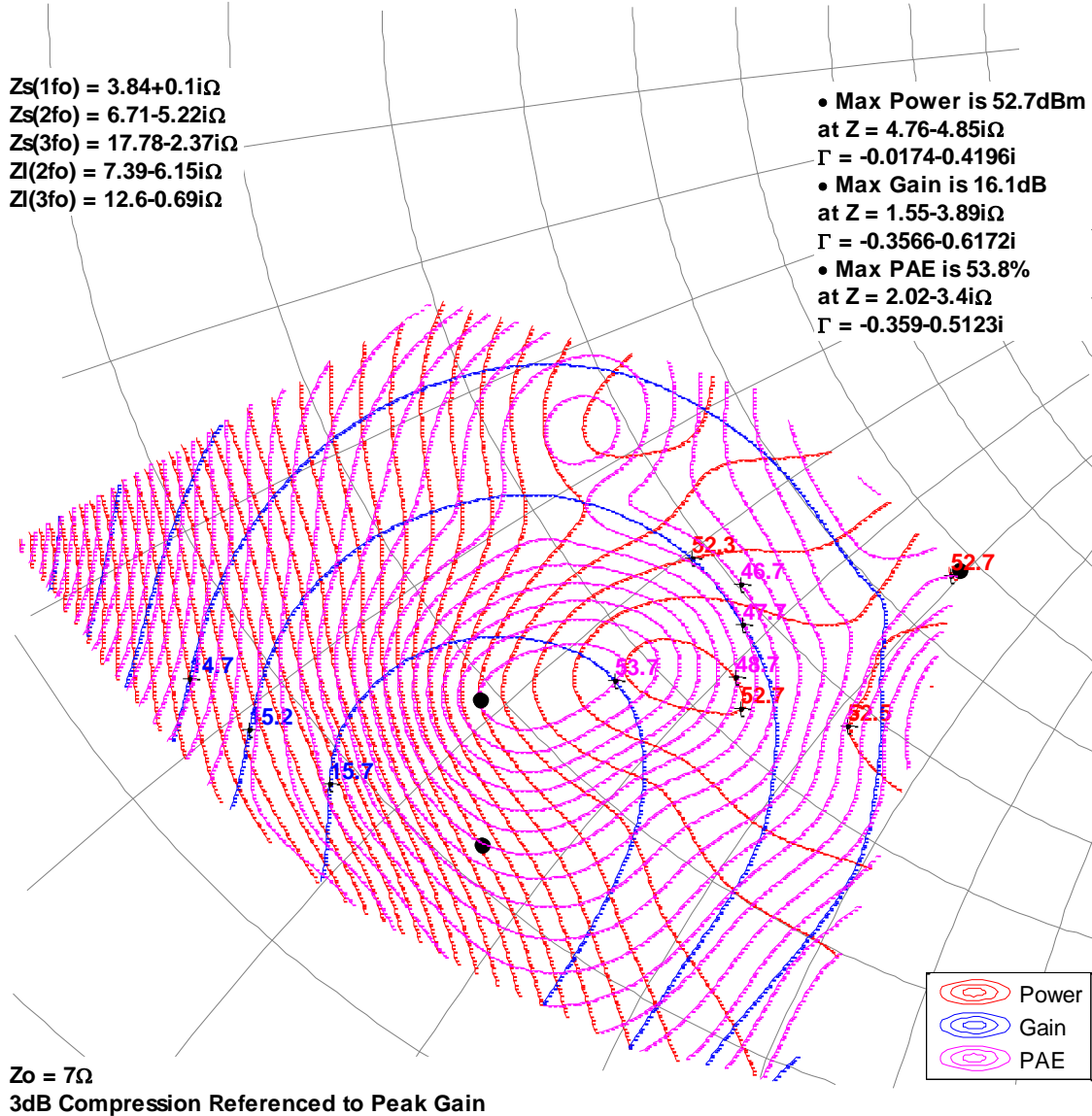

Typical Measured Performance – Load-Pull Drive-up^{1, 2}

Notes:

1. Test Conditions: $V_D = 50\text{ V}$, $I_{DQ} = 200\text{ mA}$, 100 μs Pulse Width, 20% Duty Cycle
2. See page 22 for load-pull and source-pull reference planes where the performance was measured.

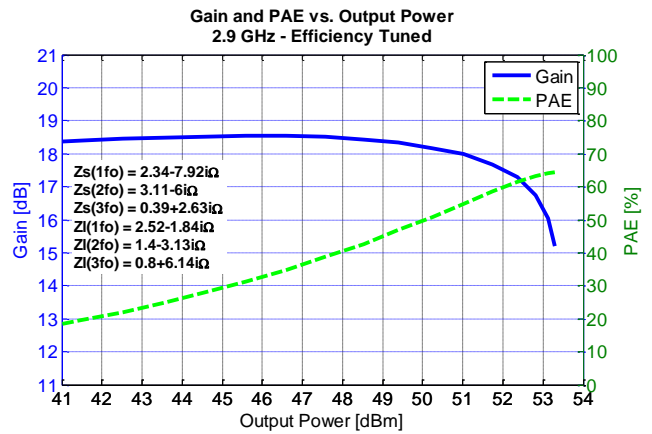
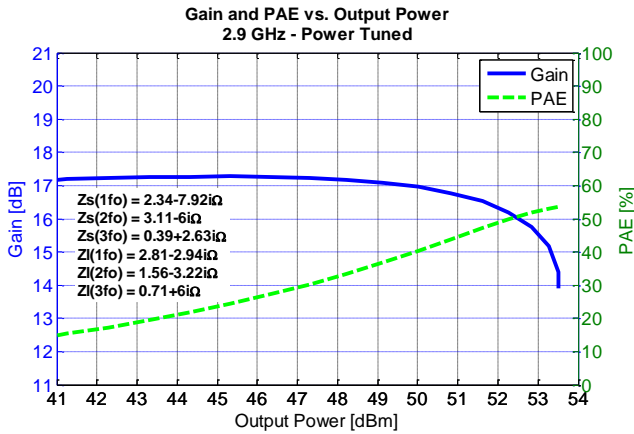
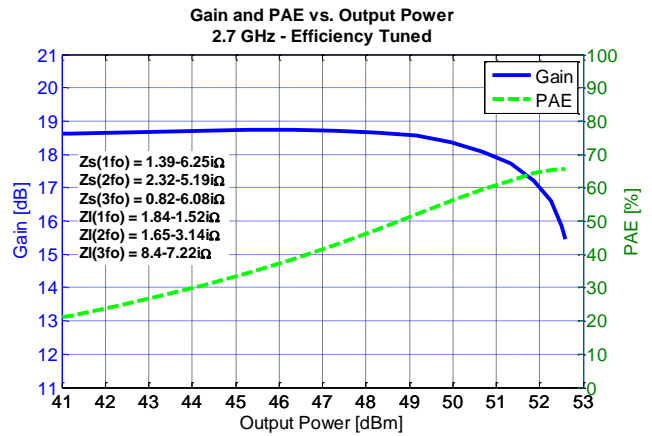
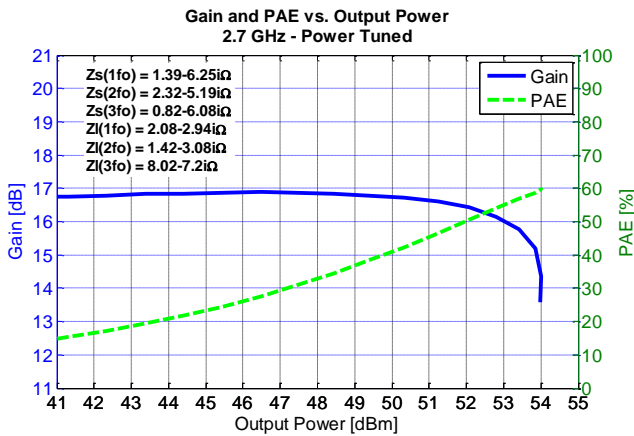

Typical Measured Performance – Load-Pull Drive-up^{1, 2}

Notes:

1. C Test Conditions: $V_D = 50\text{ V}$, $I_{DQ} = 200\text{ mA}$, 100 μs Pulse Width, 20% Duty Cycle
2. See page 22 for load-pull and source-pull reference planes where the performance was measured.

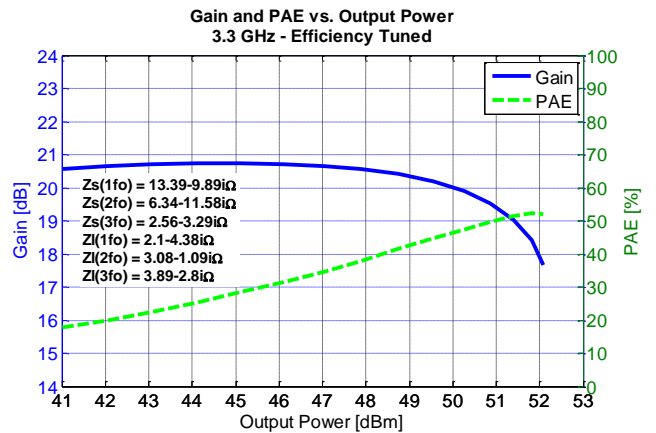
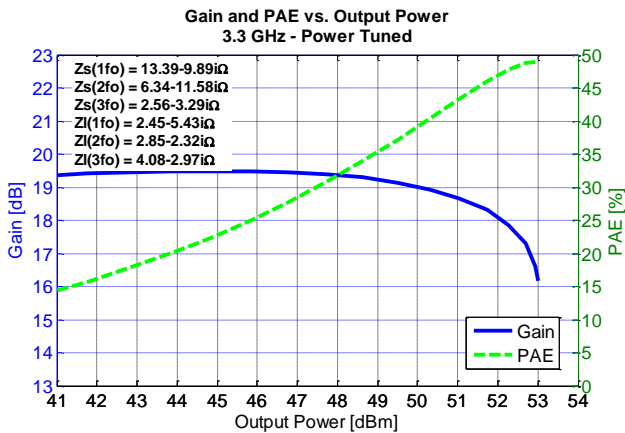
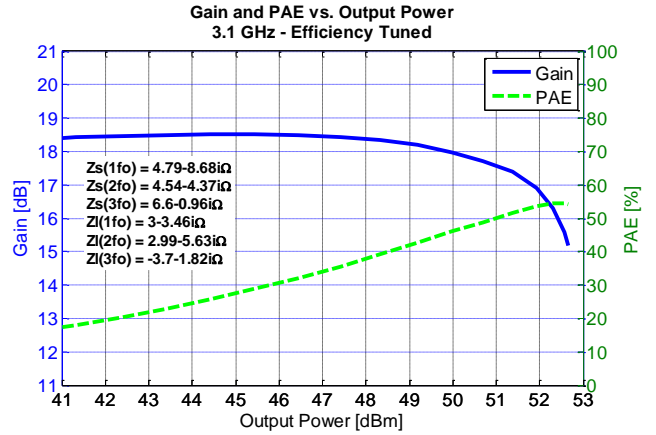
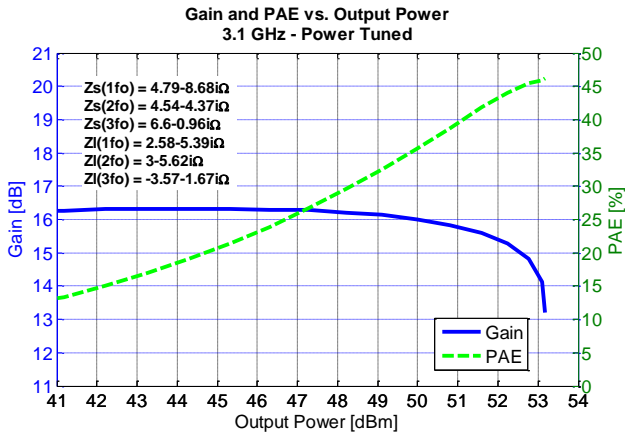

Typical Measured Performance – Load-Pull Drive-up^{1, 2}

Notes:

1. Test Conditions: $V_D = 50\text{ V}$, $I_{DQ} = 200\text{ mA}$, 100 μs Pulse Width, 20% Duty Cycle
2. See page 22 for load-pull and source-pull reference planes where the performance was measured.

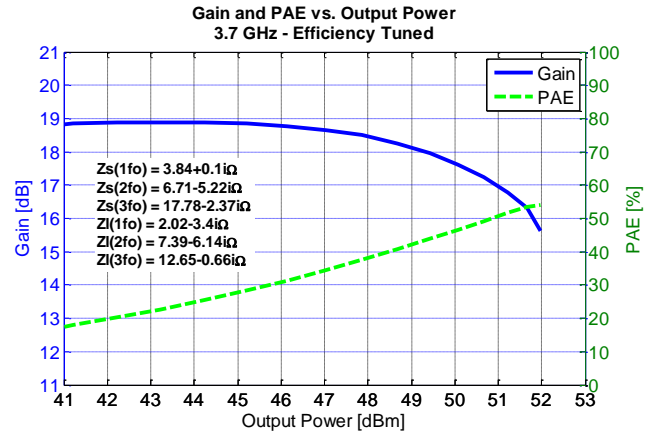
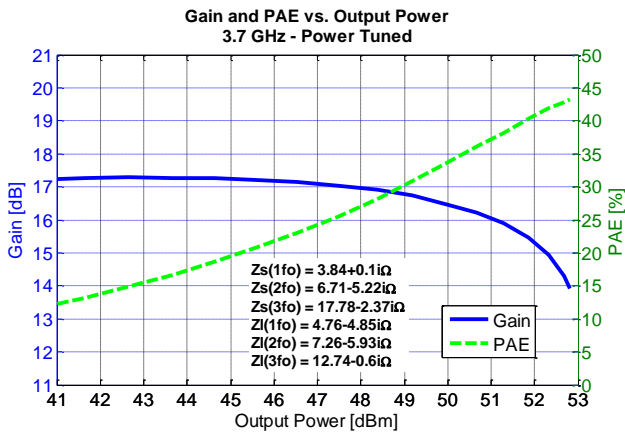
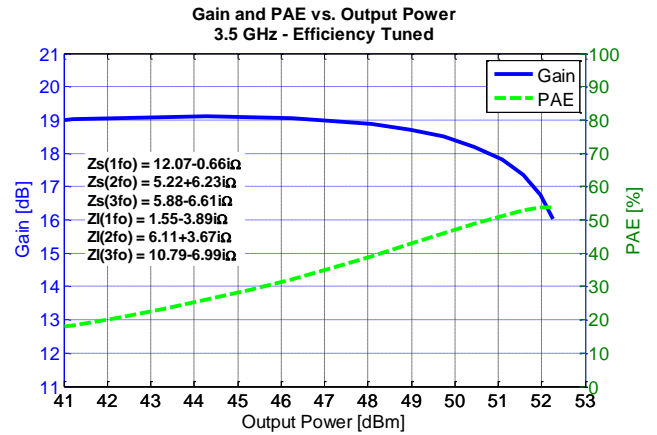
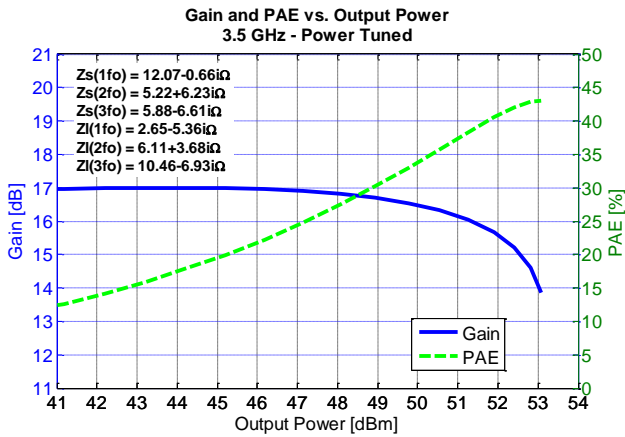

Power Driveup Performance Over Temperatures Of 3.1 – 3.5 GHz EVB^{1,2}

Notes:

1. Test Conditions: $V_D = 32\text{ V}$, $I_{DQ} = 250\text{ mA}$, 20 μs Pulse Width, 20% Duty Cycle
2. The dissipation power limit is conservative because it is specified at DUT only without accounting for the loss of the output matching network.

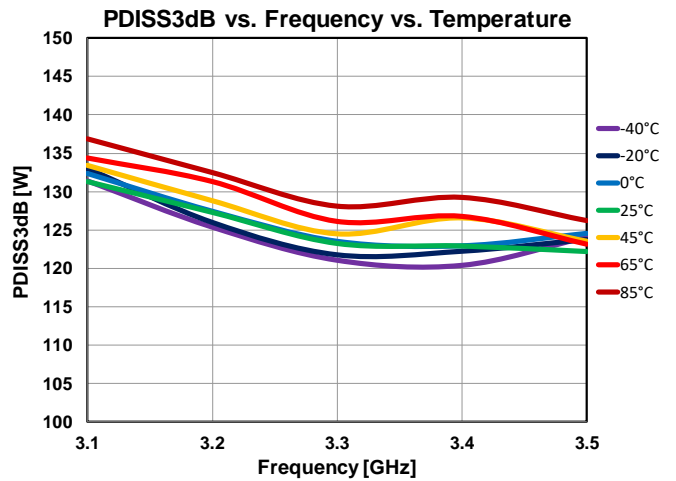
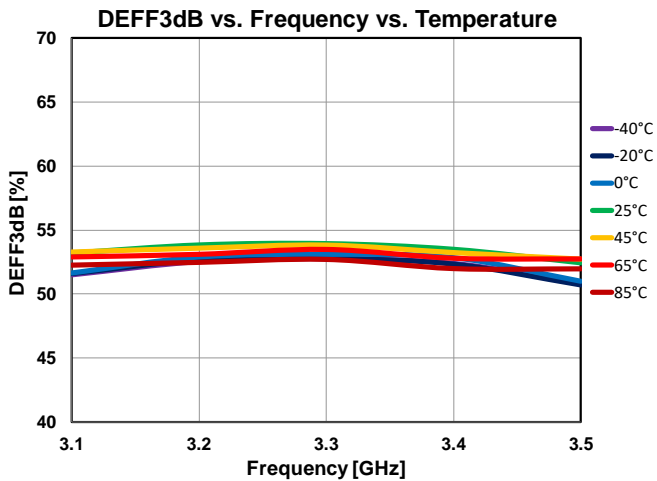
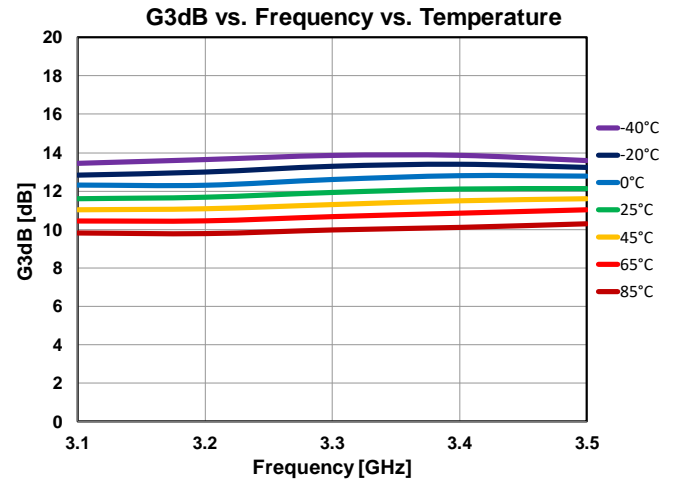
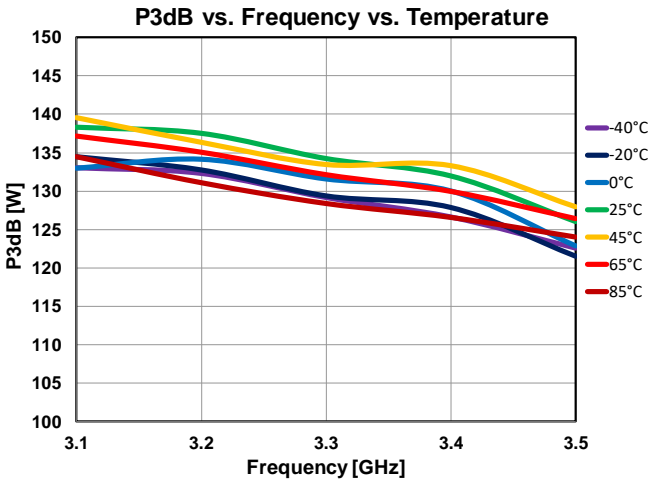

Power Driveup Performance At 25°C Of 3.1 – 3.5 GHz EVB^{1, 2}

Notes:

1. Test Conditions: $V_D = 32\text{ V}$, $I_{DQ} = 250\text{ mA}$, 20 μs Pulse Width, 20% Duty Cycle
2. The dissipation power limit is conservative because it is specified at DUT only without accounting for the loss of the output matching network..

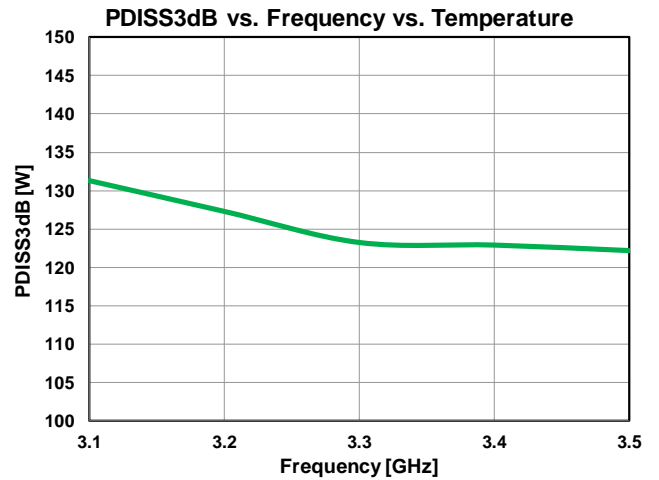
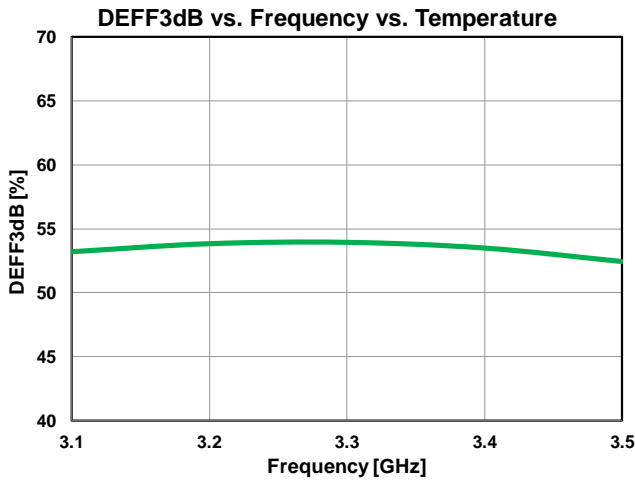
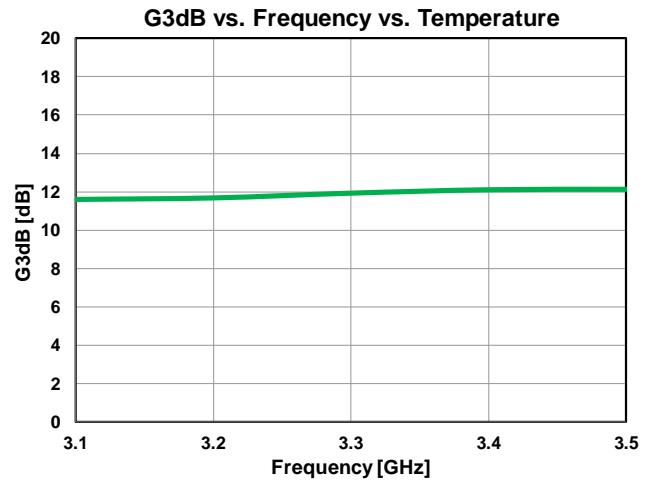
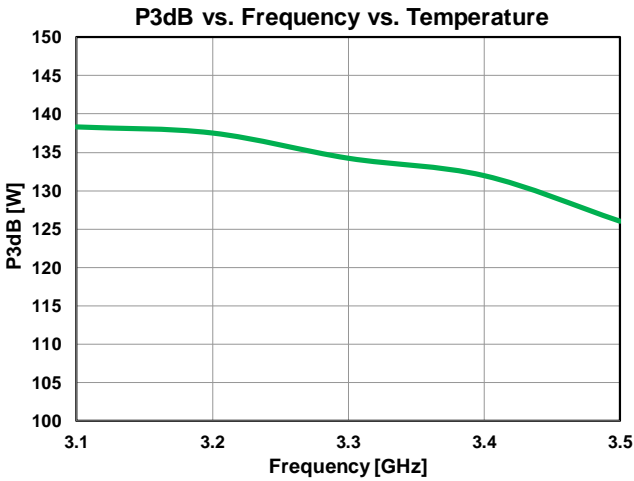

Power Driveup Performance At 25°C Of 1.35 – 1.75 GHz EVB^{1,2}

Notes:

1. Test Conditions: $V_D = 50\text{ V}$, $I_{DQ} = 200\text{ mA}$, 500 μs Pulse Width, 50% Duty Cycle
2. The dissipation power limit is conservative because it is specified at DUT only without accounting for the loss of the output matching network..

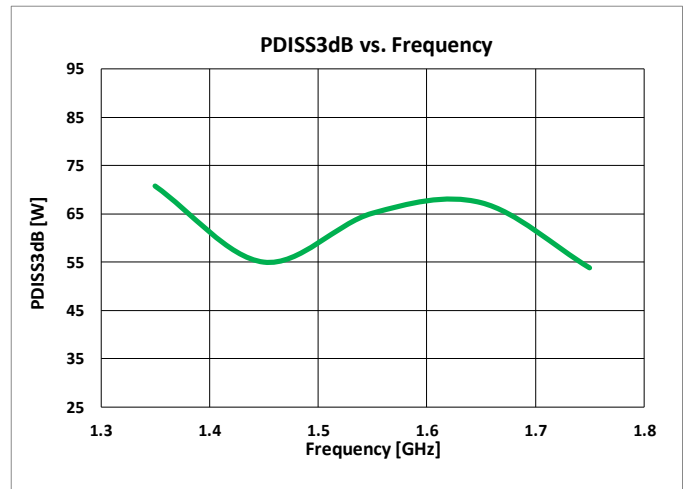
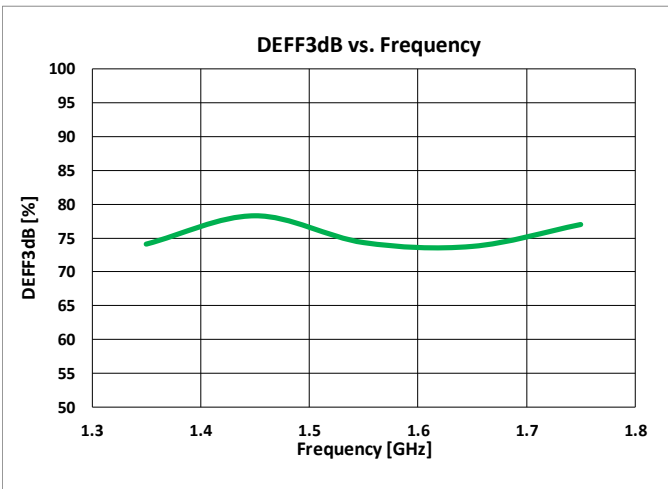
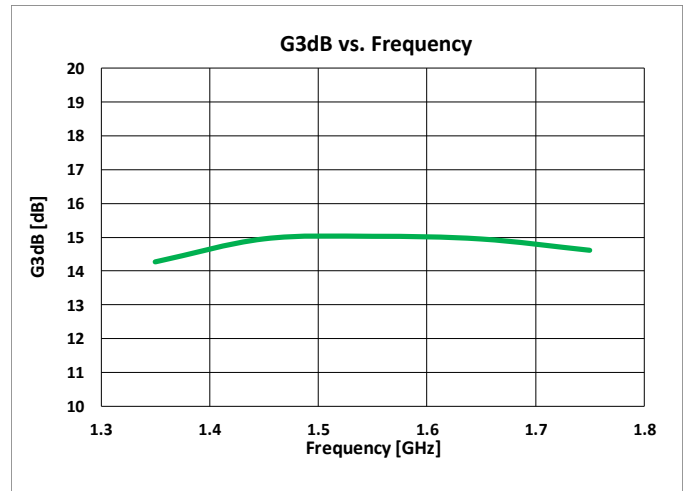
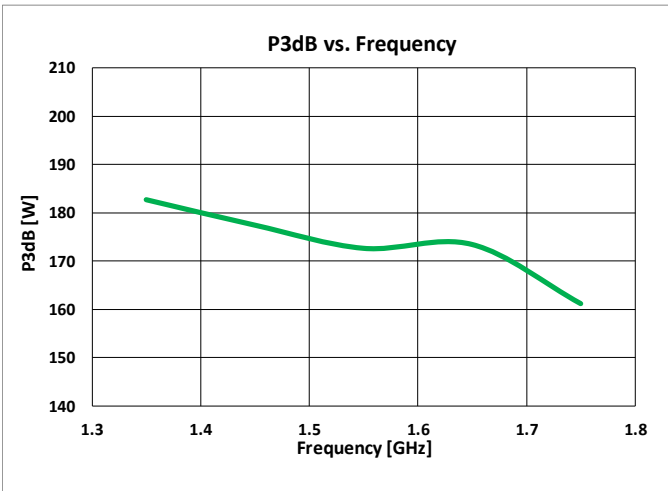

Thermal and Reliability Information – Pulsed¹

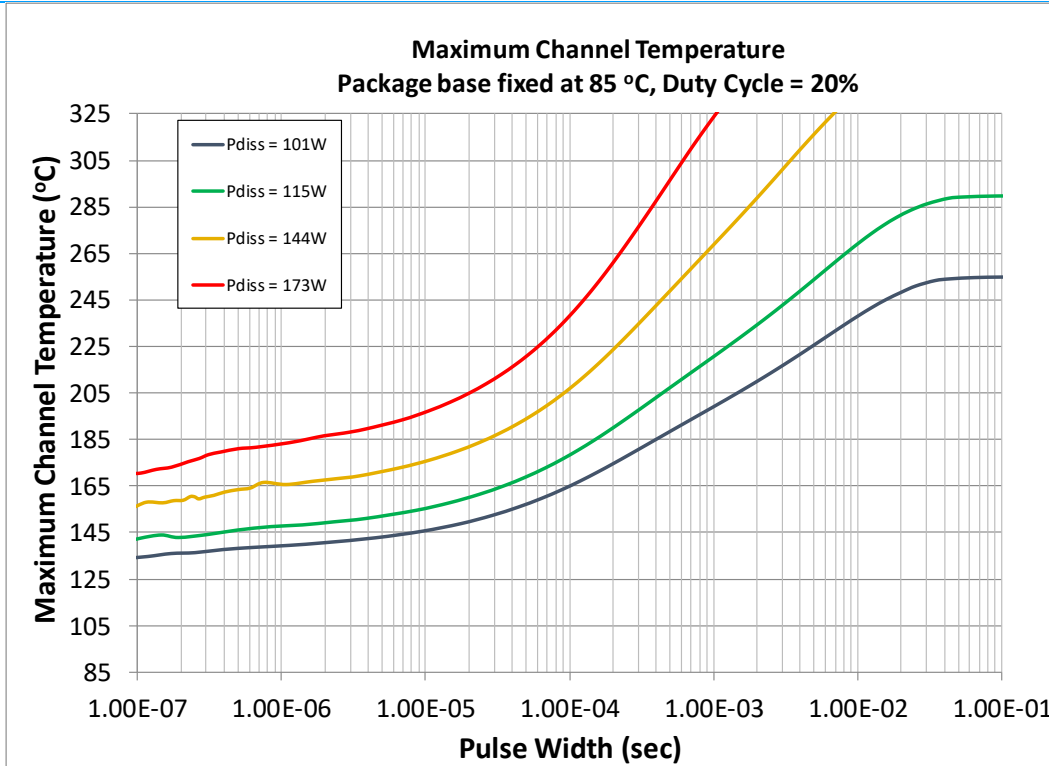

Parameter	Conditions	Values	Units
Thermal Resistance, FEA (θ_{JC})		0.79	°C/W
Peak Channel Temperature, FEA (T_{CH})	85 °C Case	165	°C
Median Lifetime, FEA (T_M) ²	101 W Pdiss, 100 uS PW, 20% DC	5.8E9	Hrs
Peak Channel Temperature, IR		139	°C
Thermal Resistance, FEA (θ_{JC})		0.82	°C/W
Peak Channel Temperature, FEA (T_{CH})	85 °C Case	179	°C
Median Lifetime, FEA (T_M) ²	115 W Pdiss, 100 uS PW, 20% DC	1.5E9	Hrs
Peak Channel Temperature, IR		148	°C
Thermal Resistance, FEA (θ_{JC})		0.85	°C/W
Peak Channel Temperature, FEA (T_{CH})	85 °C Case	207	°C
Median Lifetime, FEA (T_M) ²	144 W Pdiss, 100 uS PW, 20% DC	1.2E8	Hrs
Peak Channel Temperature, IR		165	°C
Thermal Resistance, FEA (θ_{JC})		0.88	°C/W
Peak Channel Temperature, FEA (T_{CH})	85 °C Case	238	°C
Median Lifetime, FEA (T_M) ²	173 W Pdiss, 100 uS PW, 20% DC	1.0E7	Hrs
Peak Channel Temperature, IR		183	°C

Note:

- FEA: Finite Element Analysis Method, IR: Infra-Red Method
- Median Lifetime under pulsed condition is that under CW condition divided by duty cycle.

Thermal and Reliability Information – CW¹

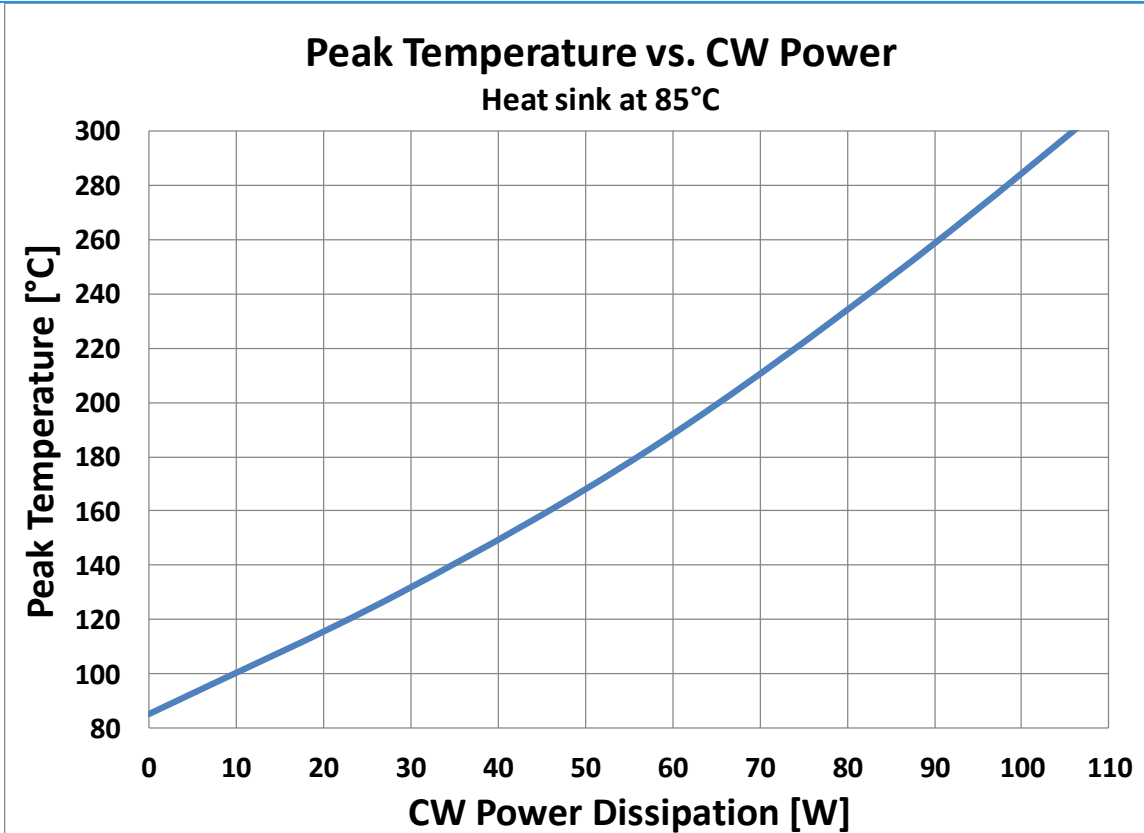

Parameter	Conditions	Values	Units
Thermal Resistance, FEA (θ_{JC})		1.46	°C/W
Peak Channel Temperature, FEA (T_{CH})	85 °C Case	169	°C
Median Lifetime, FEA (T_M) ²	57.6 W Pdiss	7.7E8	Hrs
Peak Channel Temperature, IR		142	°C
Thermal Resistance, FEA (θ_{JC})		1.62	°C/W
Peak Channel Temperature, FEA (T_{CH})	85 °C Case	225	°C
Median Lifetime, FEA (T_M) ²	86.4 W Pdiss	5.5E6	Hrs
Peak Channel Temperature, IR		175	°C
Thermal Resistance, FEA (θ_{JC})		1.71	°C/W
Peak Channel Temperature, FEA (T_{CH})	85 °C Case	257	°C
Median Lifetime, FEA (T_M) ²	100.8 W Pdiss	5.2E5	Hrs
Peak Channel Temperature, IR		193	°C
Thermal Resistance, FEA (θ_{JC})		1.79	°C/W
Peak Channel Temperature, FEA (T_{CH})	85 °C Case	291	°C
Median Lifetime, FEA (T_M) ²	115.2 W Pdiss	5.3E4	Hrs
Peak Channel Temperature, IR		213	°C

Note:

1. FEA: Finite Element Analysis Method, IR: Infra-Red Method
2. Median Lifetime under pulsed condition is that under CW condition divided by duty cycle.

Median Lifetime¹

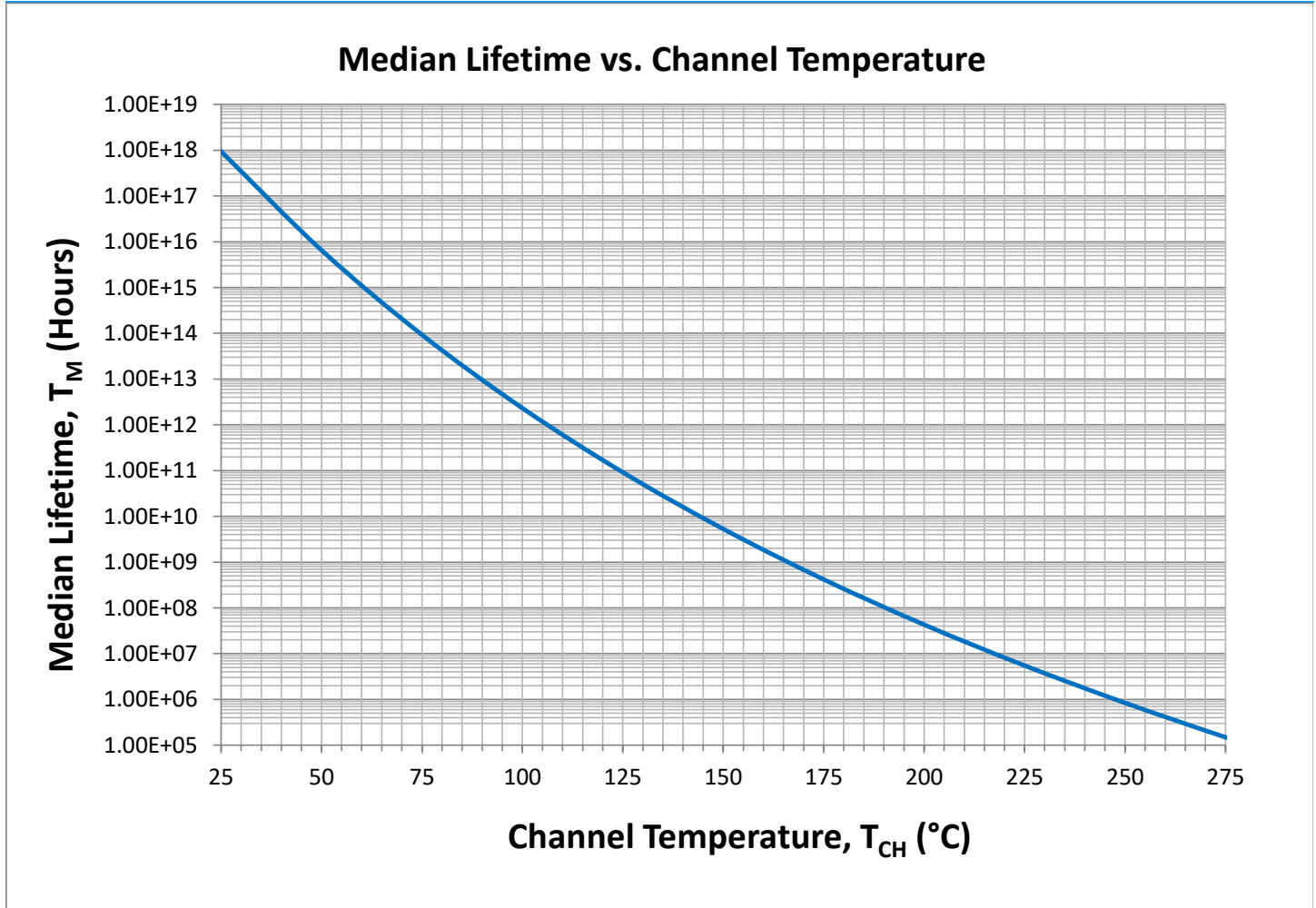

Notes:

1. Test Conditions: $V_D = +50V$; Failure Criteria = 10 % reduction in I_{D_MAX} during DC Life Testing .

Maximum Gate Current

Maximum Gate Current Vs. Channel Temperature

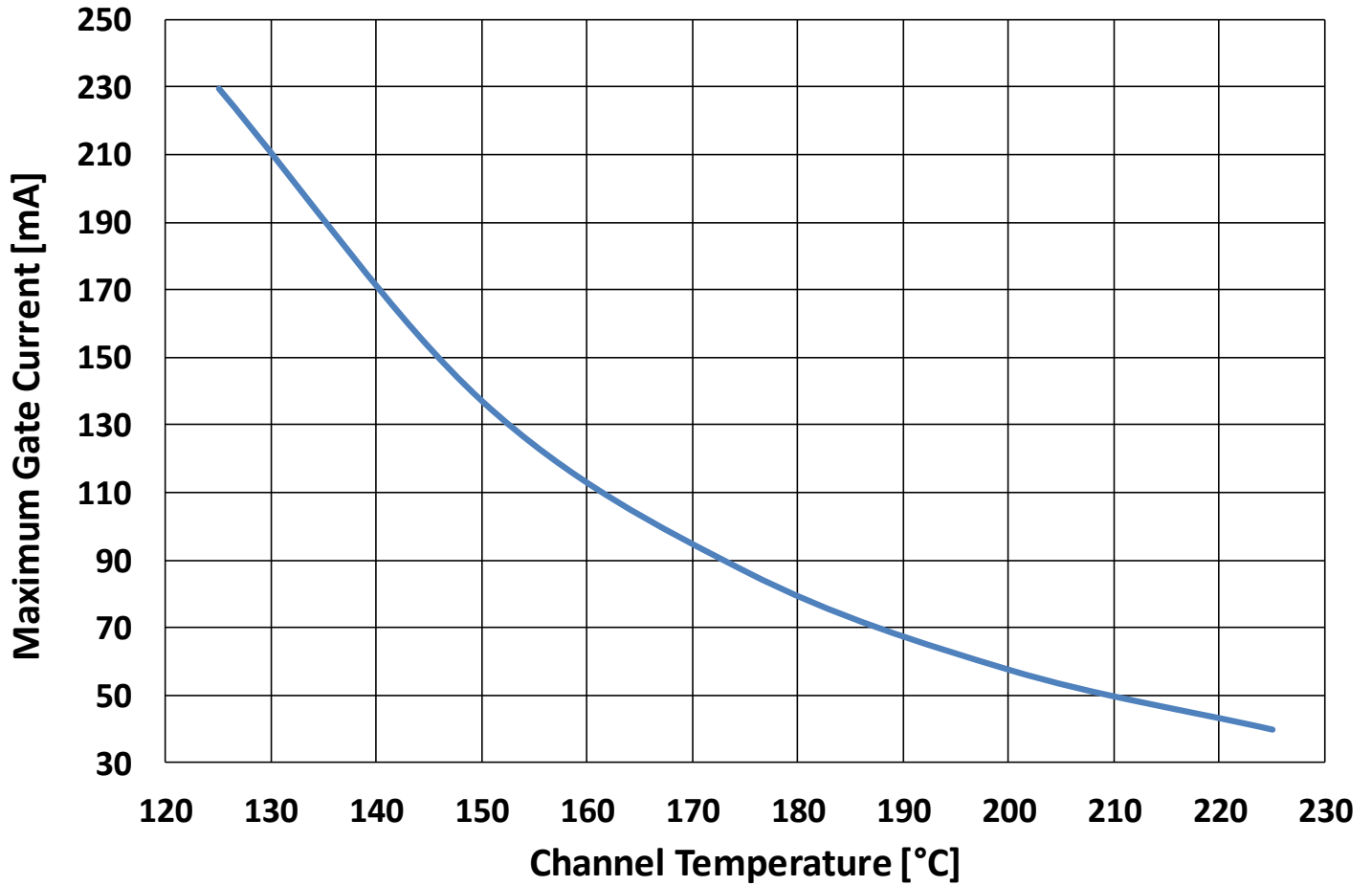

Pin Configuration and Description¹

Note 1: The TGF2819-FS will be marked with the “TGF2819-FS” designator and a lot code marked below the part designator. The “YY” represents the last two digits of the calendar year the part was manufactured, the “WW” is the work week of the assembly lot start, the MXXX” is the production lot number, and the “ZZZ” is an auto-generated serial number.

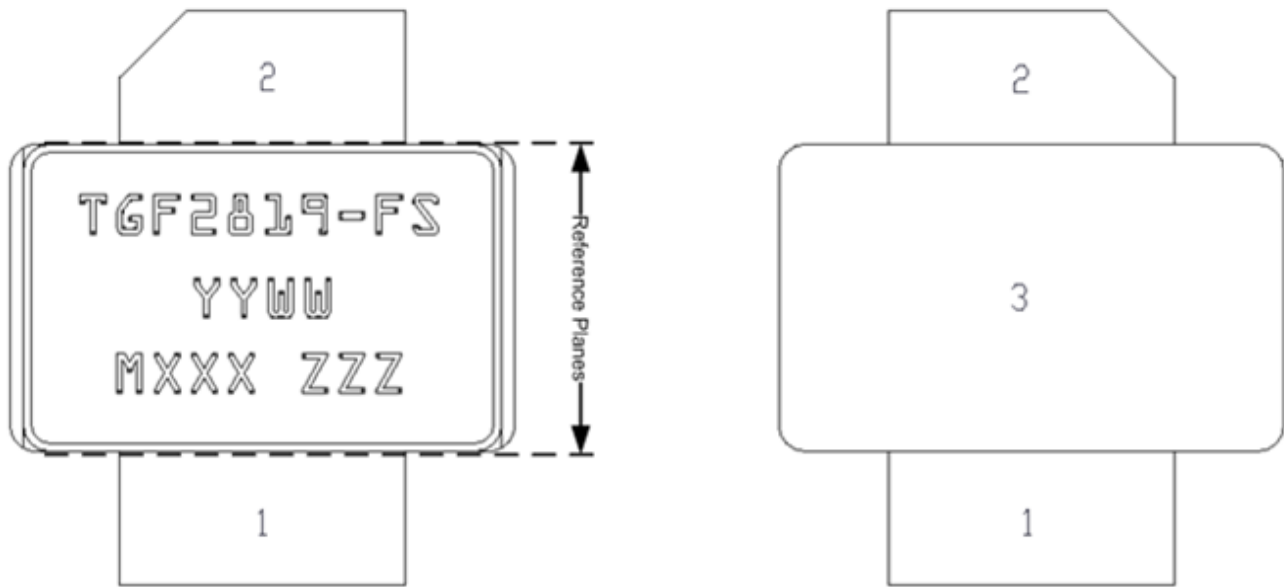

Pin	Symbol	Description
1	RF IN / V_G	Gate
2	RF OUT / V_D	Drain
3	Source	Source / Ground / Backside of part

Mechanical Drawing¹⁻⁷

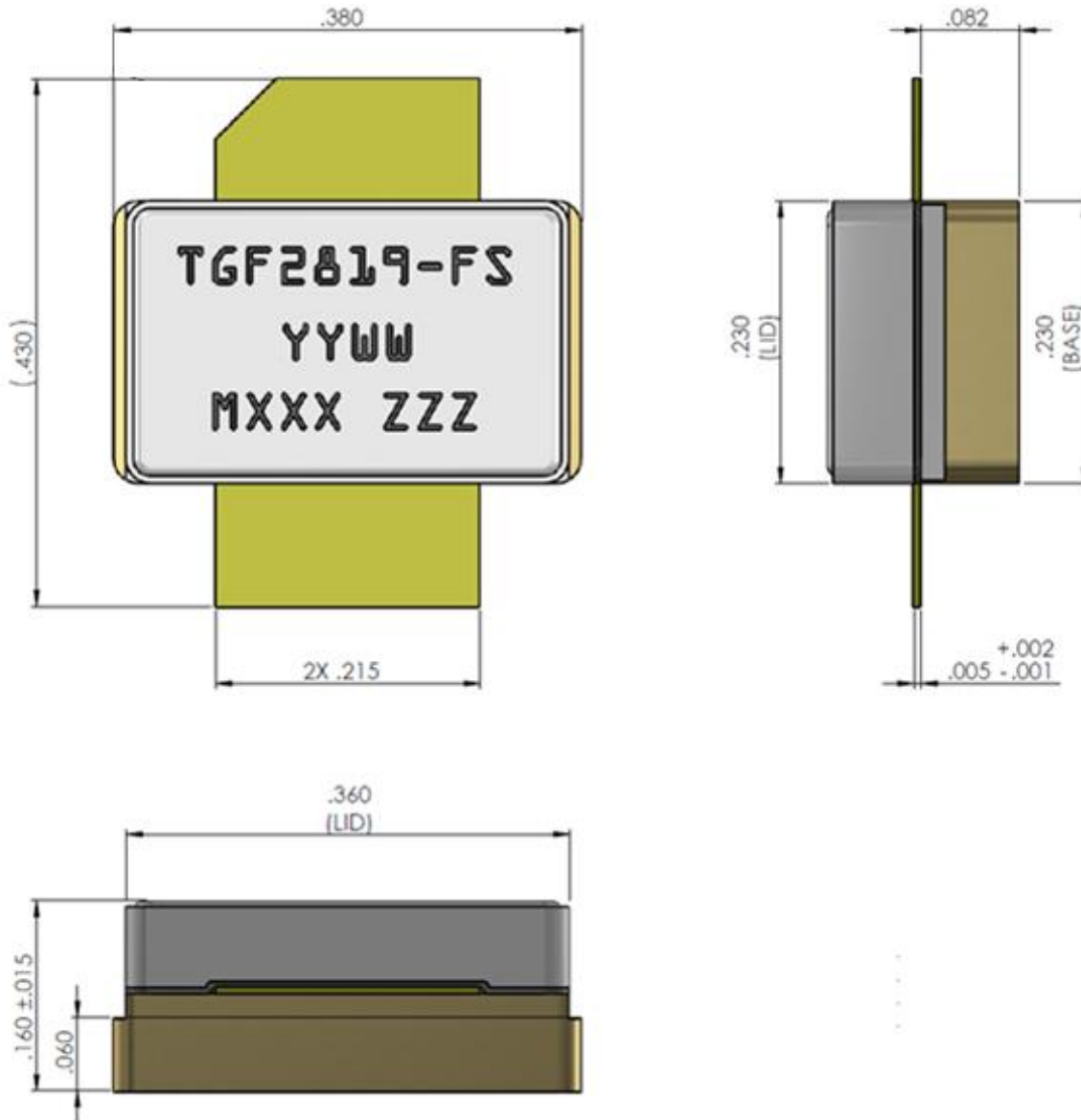

Note:

1. All dimensions are in inches. Angles are in degrees.
2. Dimension tolerance is ± 0.005 inches, unless otherwise noted.
3. Material:
 Package Base: Ceramic / Metal
 Package Lid: Ceramic
4. Package exposed metallization is gold plated.
5. Part is epoxy sealed.
6. Part meets industry NI360 footprint.
7. Body dimensions do not include epoxy runout which can be up to 0.020 inches per side.

3.1 – 3.5 GHz Application Circuit - Schematic

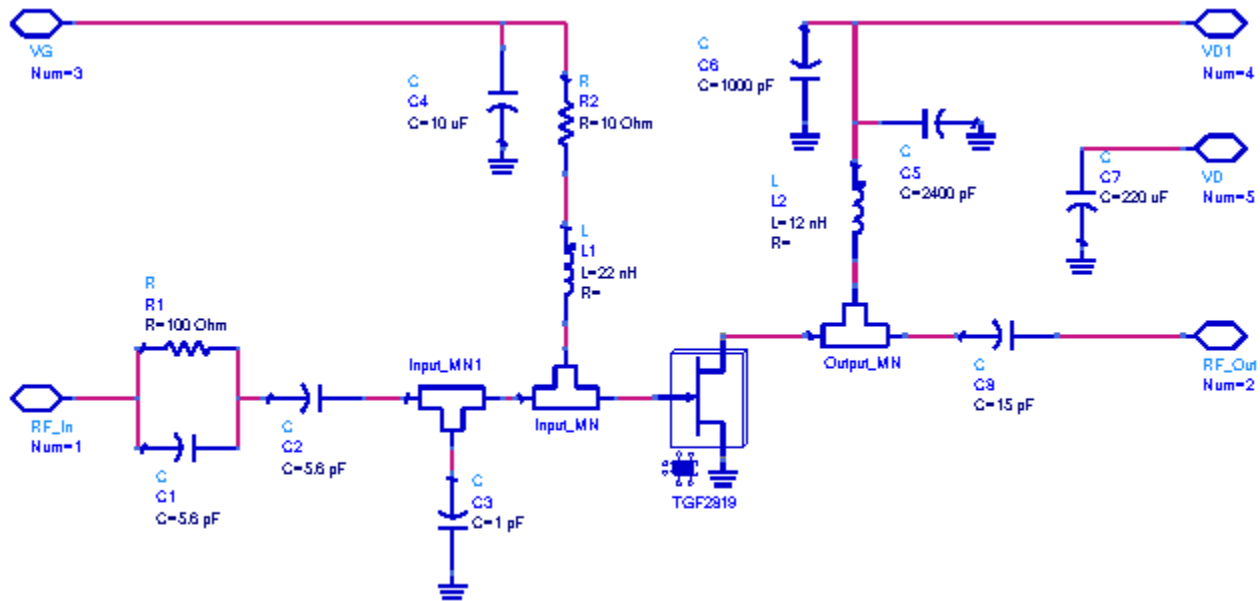

Bias-up Procedure	Bias-down Procedure
1. Set V_G to -4 V.	1. Turn off RF signal.
2. Set I_D current limit to 260 mA.	2. Turn off V_D
3. Apply 32 V V_D .	3. Wait 2 seconds to allow drain capacitor to discharge.
4. Slowly adjust V_G until I_D is set to 250 mA.	4. Turn off V_G
5. Set I_D current limit to 2 A (Pulsed operation.)	
6. Apply RF.	

3.1 – 3.5 GHz Application Circuit - Bill of Materials

Reference Design	Value	Qty	Manufacturer	Part Number
R1	100Ω	1	Vishay/Dale	CRCW0603100RJNTA
C1, C2	5.6pF	2	ATC	600S5R6BW250XT
C3	1.0pF	1	ATC	600S1R0AT250XT
L1	22nH	1	Coilcraft	0805CS-220XJEC
R2	10Ω	1	Vishay/Dale	CRCW060310R0JNTA
C4	10uF	1	Murata	C1632X5R0J106M130AC
L2	12nH	1	Coilcraft	A04TJLC
C5	2400pF	1	Murata	C08BL242X-5UN-X0T
C6	1000pF	1	ATC	800B102JT50XT
C7	220uF	1	Panasonic	EEEFK1H221P
C8	15pF	1	ATC	600S150FT250XT

3.1 – 3.5 GHz Application Circuit - Layout

Board material is RO4350B 0.020" thickness with 2oz copper cladding. Overall EVB size is 3" x 4".

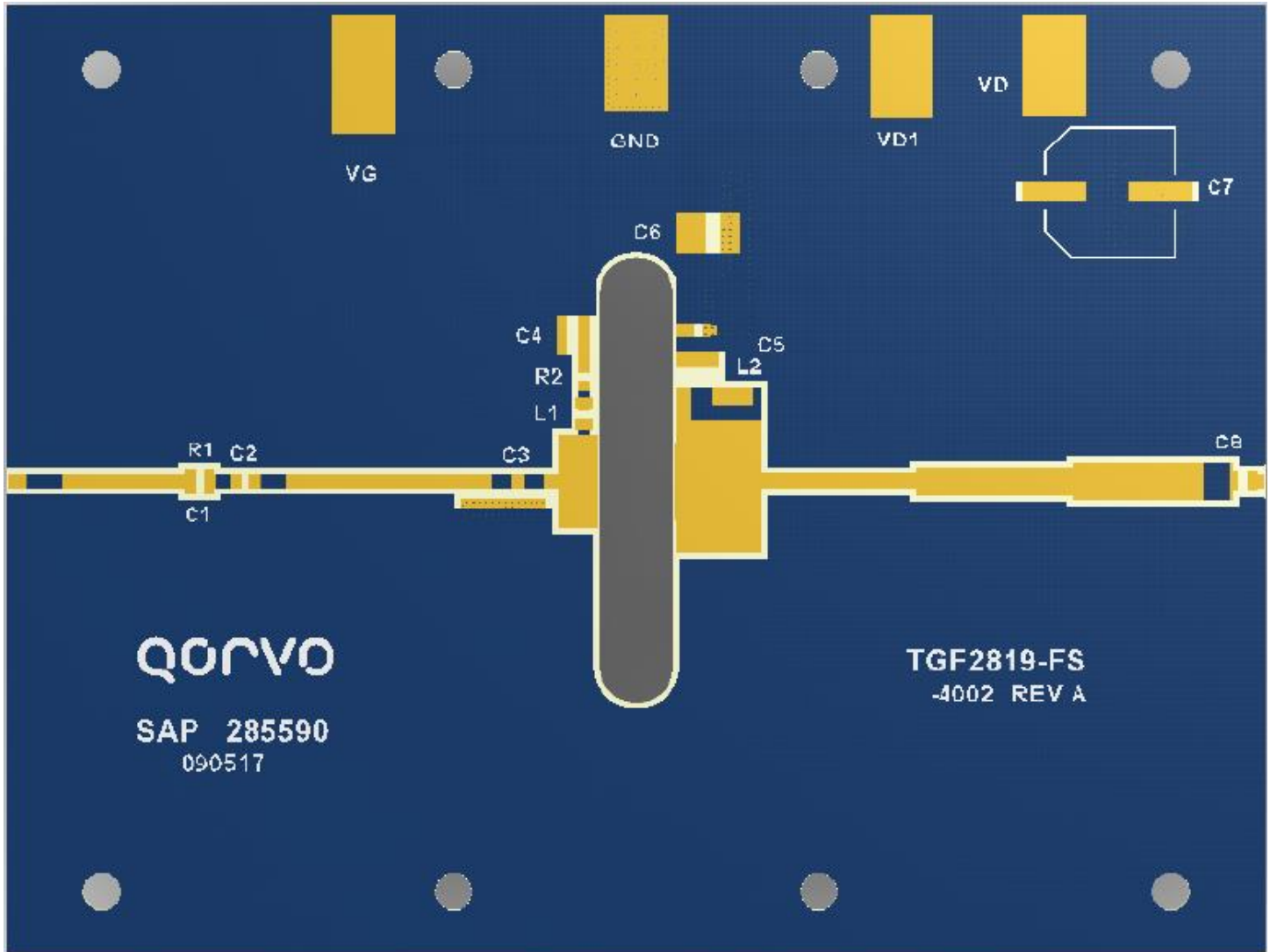

1.35 – 1.75 GHz Application Circuit - Schematic

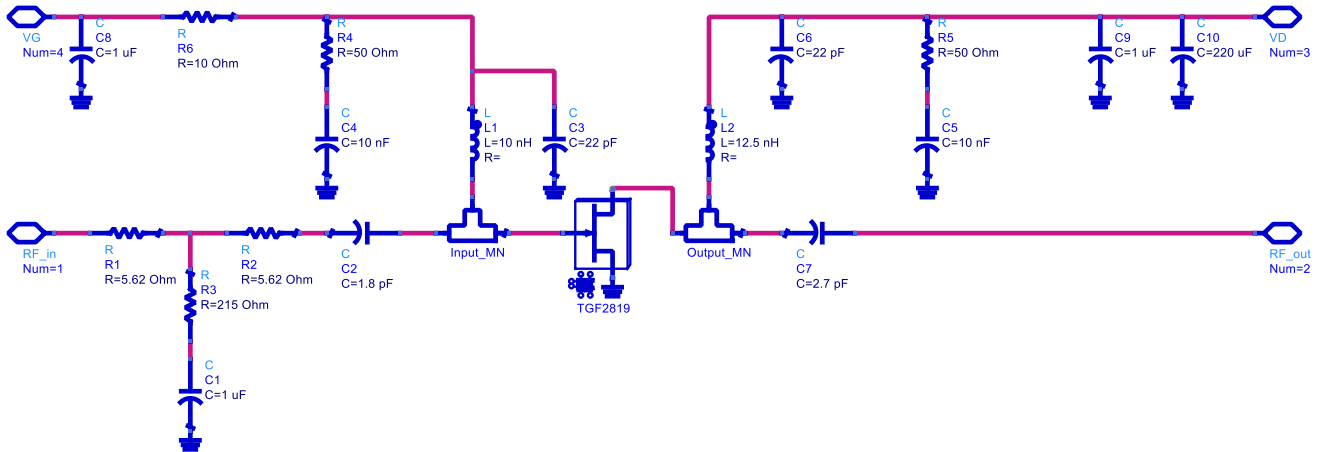

Bias-up Procedure	Bias-down Procedure
2. Set V_G to -4 V.	3. Turn off RF signal.
4. Set I_D current limit to 220 mA.	4. Turn off V_D
5. Apply 50 V V_D .	5. Wait 2 seconds to allow drain capacitor to discharge.
6. Slowly adjust V_G until I_D is set to 200 mA.	7. Turn off V_G
8. Set I_D current limit to 3.5 A (Pulsed operation.)	
9. Apply RF.	

1.35 – 1.75 GHz Application Circuit - Bill of Materials

Reference Design	Value	Qty	Manufacturer	Part Number
C1, C8	1 uF	2	Murata	GCM188R71C105KA64D
C2	1.8 pF	1	ATC	600S1R8AT250X
C3, C6	22 pF	2	ATC	600S220FT250XT
C7	2.7 pF	1	ATC	600S2R7BW250XT
C4, C5	10 nF	2	Capax Technologies	0603X103K101S
C9	1 uF	1	TDK	CGA4J3X7S2A105K125AB
C10	220 uF	1	Panasonic	EEVTG1J221Q
L1	10 nH	1	Coilcraft	0603CS-10NXJEW
L2	12.5 nH	1	Coilcraft	A04TJLC
R1, R2	5.6 Ohm	2	Panasonic	ERJ-1TRQJ5R6U
R3	215 Ohm	1	Panasonic	ERA-8AEB2150V
R6	10 Ohm	1	Vishay	CRCW060310R0JNTA
R4, R5	50 Ohm	2	Vishay	CRCW060351R1FKEA

1.35 – 1.75 GHz Application Circuit - Layout

Board material is RO4350B 0.020" thickness with 2oz copper cladding. Overall EVB size is 3" x 4".

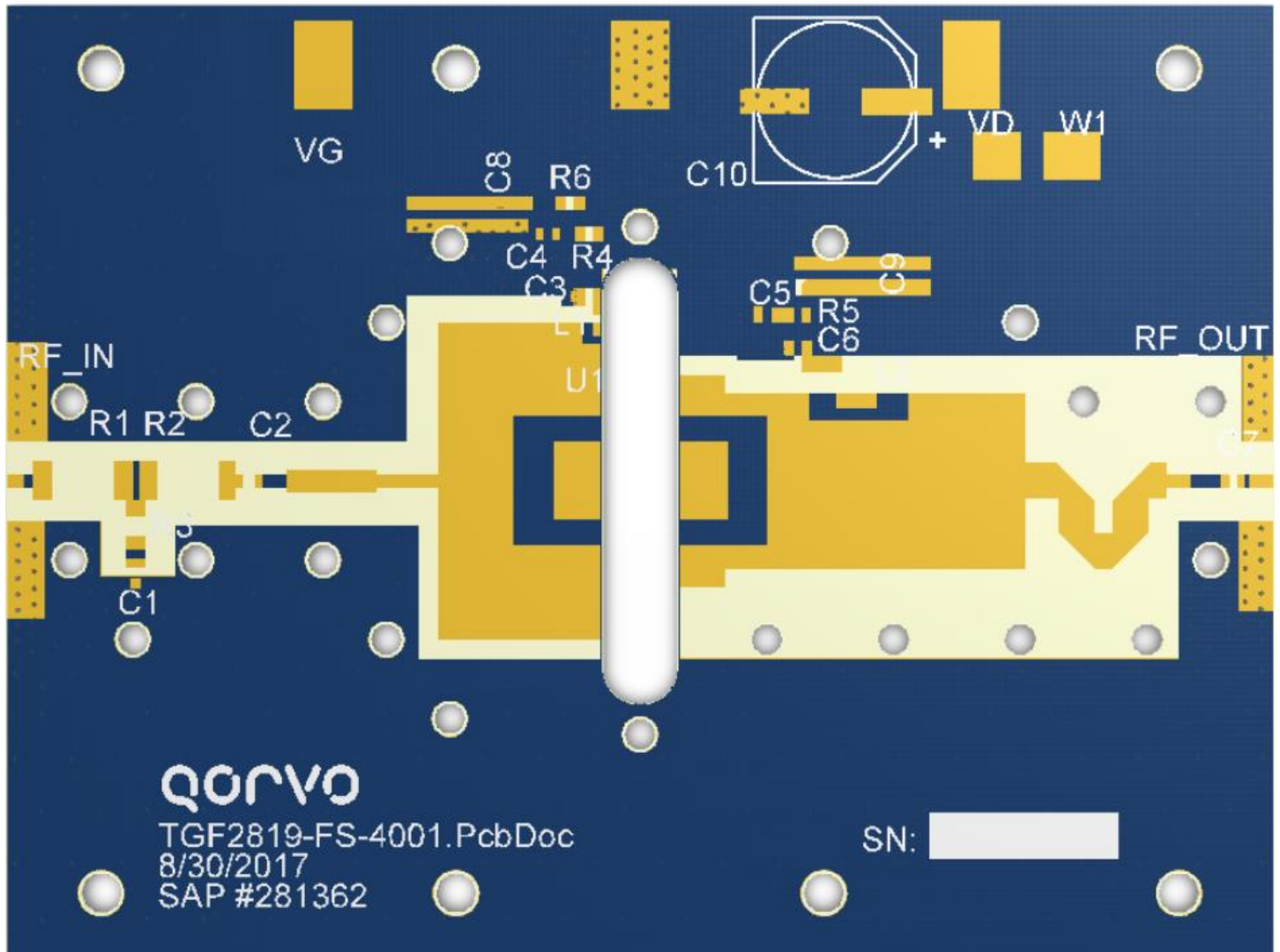

Recommended Solder Temperature Profile

