



TGF2979-SM

25 W, 32 V, DC – 12 GHz, GaN RF Transistor

Product Overview

The Qorvo TGF2979-SM is a 25 W (P3dB) discrete GaN on SiC HEMT which operates from DC to 12 GHz. The device is constructed with Qorvo’s proven QGaN25 process, which features advanced field plate techniques to optimize power and efficiency at high drain bias operating conditions. This optimization can potentially lower system costs in terms of fewer amplifier line-ups and lower thermal management costs.

The device is housed in an industry-standard 3 x 4 mm surface mount QFN package.

Lead-free and ROHS compliant

Evaluation boards are available upon request

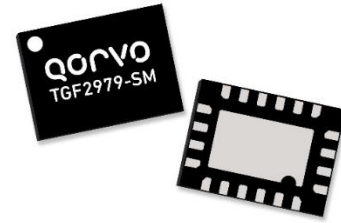

20 Pad 3 x 4 mm Package

Key Features

- Frequency: DC to 12 GHz
- Output Power (P3dB)¹: 22 W
- Linear Gain¹: 11 dB
- Typical PAE (3dB)¹: 45%
- Operating Voltage: 32 V
- Low thermal resistance package
- CW and Pulse capable
- 3 x 4 mm package

Note: @ 9.4 GHz

Functional Block Diagram

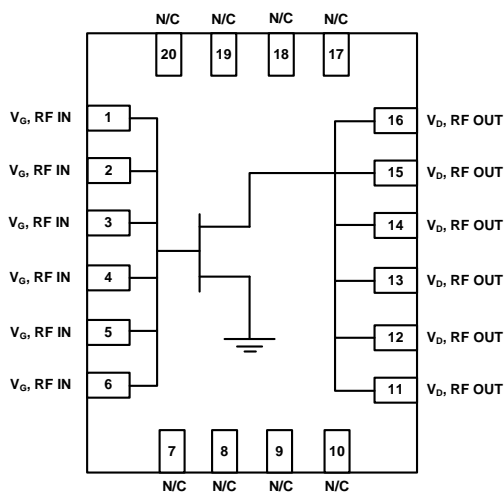

Applications

- Military radar
- Commercial radar
 - Avionics
 - Marine
 - Weather

Ordering Information

| Part No. | Description |
|-----------------|------------------------------|
| TGF2979-SMEVB01 | 2.6-3.2 GHz Evaluation Board |
| TGF2979-SMEVB02 | 2.8-3.4 GHz Evaluation Board |
| TGF2979-SMEVB03 | 3-3.6 GHz Evaluation Board |

Absolute Maximum Ratings

| Parameter | Value | Units |
|---|--------------|------------------|
| Breakdown Voltage (BV_{DG}) | 100 | V |
| Gate Voltage Range (V_G) | -7 to +2 | V |
| Drain Current (I_D) | 3.6 | A |
| Gate Current (I_G) | -7.5 to 12.6 | mA |
| Power Dissipation, CW (P_D) | See page 4. | W |
| RF Input Power, CW, $T=25^\circ\text{C}$ (P_{IN}) | 37.8 | dBm |
| Storage Temperature | -40 to 150 | $^\circ\text{C}$ |

Exceeding any one or a combination of the Absolute Maximum Rating conditions may cause permanent damage to the device. Extended application of Absolute Maximum Rating conditions to the device may reduce device reliability.

Recommended Operating Conditions

| Parameter | Min | Typ | Max | Units |
|--------------------------------------|-----|------|-----|-------|
| Drain Voltage (V_D) | | +32 | | V |
| Drain Quiescent Current (I_{DQ}) | | 150 | | mA |
| Gate Voltage (V_G) ¹ | | -2.7 | | V |

Electrical specifications are measured at specified test conditions. Specifications are not guaranteed over all recommended operating conditions.

Note:

- To be adjusted to desired I_{DQ}

Pulsed RF Characterization – Load Pull Performance

Test conditions unless otherwise noted: $T = 25^\circ\text{C}$, Pulse (20% Duty Cycle, 100 μs Width).

| Parameter | Typical Values | | | | | | Units |
|--|----------------|------|------|------|------|-------|-------|
| | 5 | 8 | 9 | 9.4 | 10 | 12 | |
| Frequency, F | | | | | | | GHz |
| Drain Voltage ^{1,2} , V_D | 32 | 32 | 32 | 32 | 32 | 32 | V |
| Drain Bias Current ^{1,2} , I_{DQ} | 150 | 150 | 150 | 150 | 150 | 150 | mA |
| Output Power at 3dB compression ¹ , P_{3dB} | 44.4 | 43.8 | 43.2 | 43.5 | 43.7 | 43.4 | dBm |
| Power Added Efficiency at 3dB compression ² , PAE_{3dB} | 56.0 | 51.0 | 49.2 | 44.9 | 40.8 | 33.00 | % |
| Gain at 3dB compression ¹ , G_{3dB} | 11.5 | 9.7 | 8.8 | 7.9 | 7.1 | 6.2 | dB |

Notes:

- Power Tuned
- Efficiency Tuned

Thermal and Reliability Information – CW⁽¹⁾

| Parameter | Simulation Conditions | Value | Units |
|--|---|-------|--------------------|
| Thermal Resistance, Peak IR Surface Temperature at Average Power (θ_{JC}) | $P_{DISS} = 45.4 \text{ W}$, $T_{baseplate} = 85 \text{ }^\circ\text{C}$ | 2.53 | $^\circ\text{C/W}$ |
| Channel Temperature (T_{CH}) | | 200 | $^\circ\text{C}$ |
| Thermal Resistance, Peak IR Surface Temperature at Average Power (θ_{JC}) | $P_{DISS} = 37.8 \text{ W}$, $T_{baseplate} = 85 \text{ }^\circ\text{C}$ | 2.43 | $^\circ\text{C/W}$ |
| Channel Temperature (T_{CH}) | | 177 | $^\circ\text{C}$ |
| Thermal Resistance, Peak IR Surface Temperature at Average Power (θ_{JC}) | $P_{DISS} = 30.2 \text{ W}$, $T_{baseplate} = 85 \text{ }^\circ\text{C}$ | 2.35 | $^\circ\text{C/W}$ |
| Channel Temperature (T_{CH}) | | 156 | $^\circ\text{C}$ |
| Thermal Resistance, Peak IR Surface Temperature at Average Power (θ_{JC}) | $P_{DISS} = 22.7 \text{ W}$, $T_{baseplate} = 85 \text{ }^\circ\text{C}$ | 2.28 | $^\circ\text{C/W}$ |
| Channel Temperature (T_{CH}) | | 137 | $^\circ\text{C}$ |
| Thermal Resistance, Peak IR Surface Temperature at Average Power (θ_{JC}) | $P_{DISS} = 15.1 \text{ W}$, $T_{baseplate} = 85 \text{ }^\circ\text{C}$ | 2.19 | $^\circ\text{C/W}$ |
| Channel Temperature (T_{CH}) | | 118 | $^\circ\text{C}$ |
| Thermal Resistance, Peak IR Surface Temperature at Average Power (θ_{JC}) | $P_{DISS} = 7.6 \text{ W}$, $T_{baseplate} = 85 \text{ }^\circ\text{C}$ | 1.96 | $^\circ\text{C/W}$ |
| Channel Temperature (T_{CH}) | | 100 | $^\circ\text{C}$ |

Note:

1. Thermal resistance measured to bottom of package.
2. Refer to the following document: [GaN Device Channel Temperature, Thermal Resistance, and Reliability Estimates](#)

Thermal and Reliability Information – Pulsed⁽¹⁾

| Parameter | Simulation Conditions | Value | Units |
|--|--|------------------|--------------------|
| Thermal Resistance, Peak IR Surface Temperature at Average Power (θ_{JC}) | $P_{DISS} = 45.4 \text{ W}$, $T_{baseplate} = 85 \text{ }^\circ\text{C}$ Pulse Width = 500 μS | 2.36 | $^\circ\text{C/W}$ |
| Channel Temperature (T_{CH}) | | Duty Cycle = 10% | 192 |
| Thermal Resistance, Peak IR Surface Temperature at Average Power (θ_{JC}) | $P_{DISS} = 37.8 \text{ W}$, $T_{baseplate} = 85 \text{ }^\circ\text{C}$ Pulse Width = 500 μS | 2.20 | $^\circ\text{C/W}$ |
| Channel Temperature (T_{CH}) | | Duty Cycle = 10% | 168 |
| Thermal Resistance, Peak IR Surface Temperature at Average Power (θ_{JC}) | $P_{DISS} = 45.4 \text{ W}$, $T_{baseplate} = 85 \text{ }^\circ\text{C}$ Pulse Width = 100 μS | 1.82 | $^\circ\text{C/W}$ |
| Channel Temperature (T_{CH}) | | Duty Cycle = 10% | 168 |
| Thermal Resistance, Peak IR Surface Temperature at Average Power (θ_{JC}) | $P_{DISS} = 37.8 \text{ W}$, $T_{baseplate} = 85 \text{ }^\circ\text{C}$ Pulse Width = 100 μS | 1.78 | $^\circ\text{C/W}$ |
| Channel Temperature (T_{CH}) | | Duty Cycle = 10% | 152 |

Note:

1. Thermal resistance measured to bottom of package.
2. Refer to the following document: [GaN Device Channel Temperature, Thermal Resistance, and Reliability Estimates](#)

Electrical Specifications

| Parameter | Conditions | Min | Typ | Max | Units |
|--------------|----------------------------|-------|-----|-----|-------|
| Gate Leakage | $V_D = +10$, $V_G = -3.7$ | -8.25 | | | mA |

Maximum Channel Temperature, CW

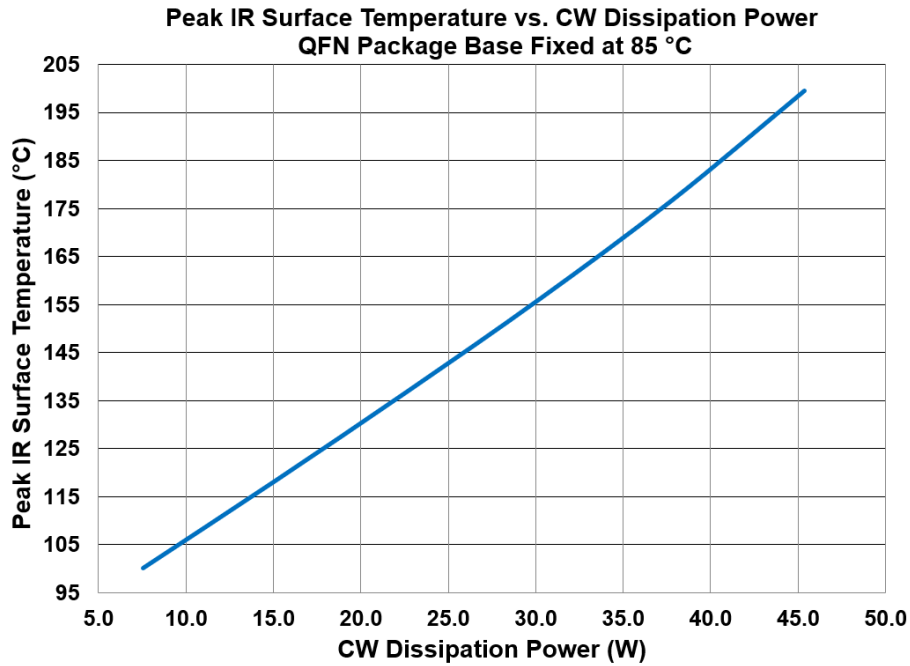

Maximum Channel Temperature, Pulsed

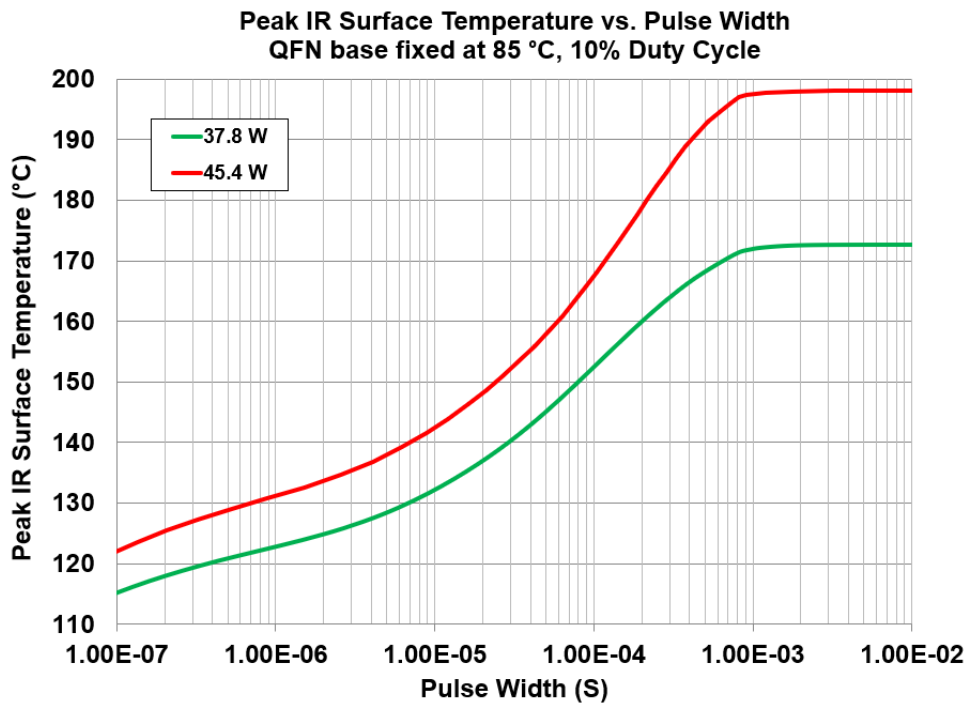

Load Pull Smith Charts – Pulsed^(1,2,3)

RF performance that the device typically exhibits when placed in the specified impedance environment. The impedances are not the impedances of the device, they are the impedances presented to the device via an RF circuit or load-pull system. The impedances listed follow an optimized trajectory to maintain high power and high efficiency.

Notes:

1. 32 V, 150 mA, Pulsed signal with 100 uS pulse width and 10 % duty cycle. Performance is at indicated input power.
2. See page 13 for load pull and source pull reference planes. 15-Ω load pull TRL fixtures are built with 10-mil RO4350B material.
3. NaN means the impedances are either undefined or varying in load-pull system.

6GHz, Load-pull

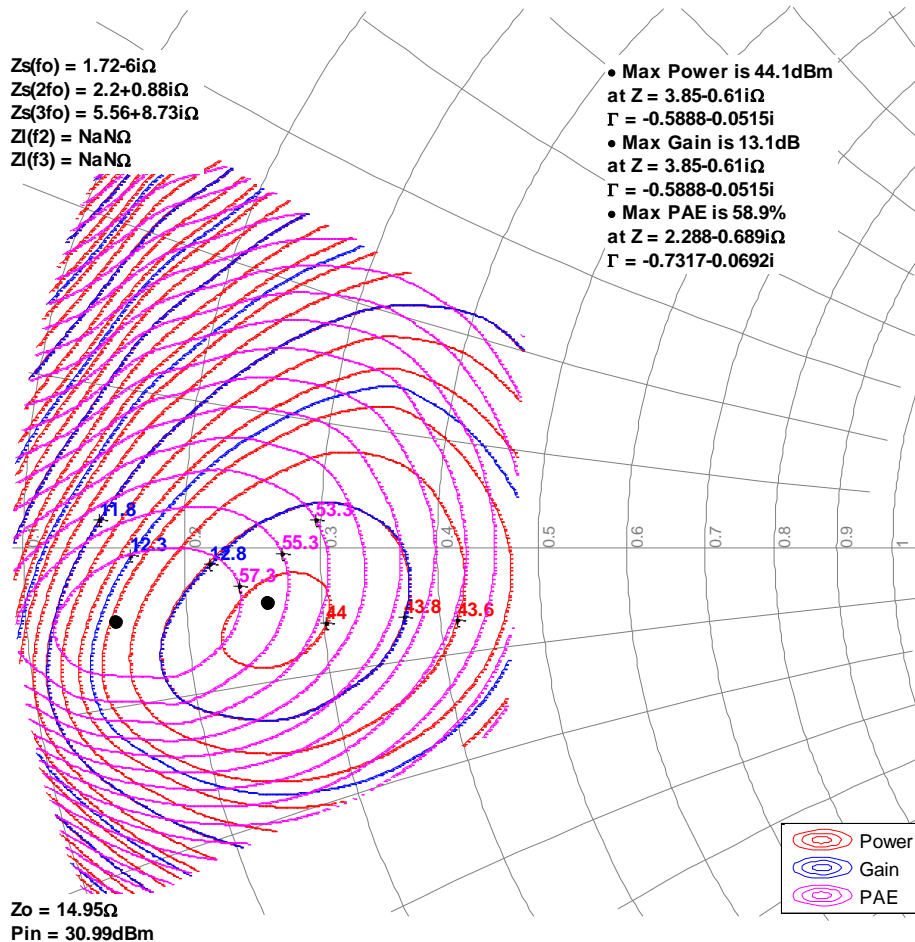

Load Pull Smith Charts – Pulsed^(1,2,3)

RF performance that the device typically exhibits when placed in the specified impedance environment. The impedances are not the impedances of the device, they are the impedances presented to the device via an RF circuit or load-pull system. The impedances listed follow an optimized trajectory to maintain high power and high efficiency.

Notes:

1. 32 V, 150 mA, Pulsed signal with 100 uS pulse width and 10 % duty cycle. Performance is at indicated input power.
2. See page 13 for load pull and source pull reference planes. 15-Ω load pull TRL fixtures are built with 10-mil RO4350B material.
3. NaN means the impedances are either undefined or varying in load-pull system.

8GHz, Load-pull

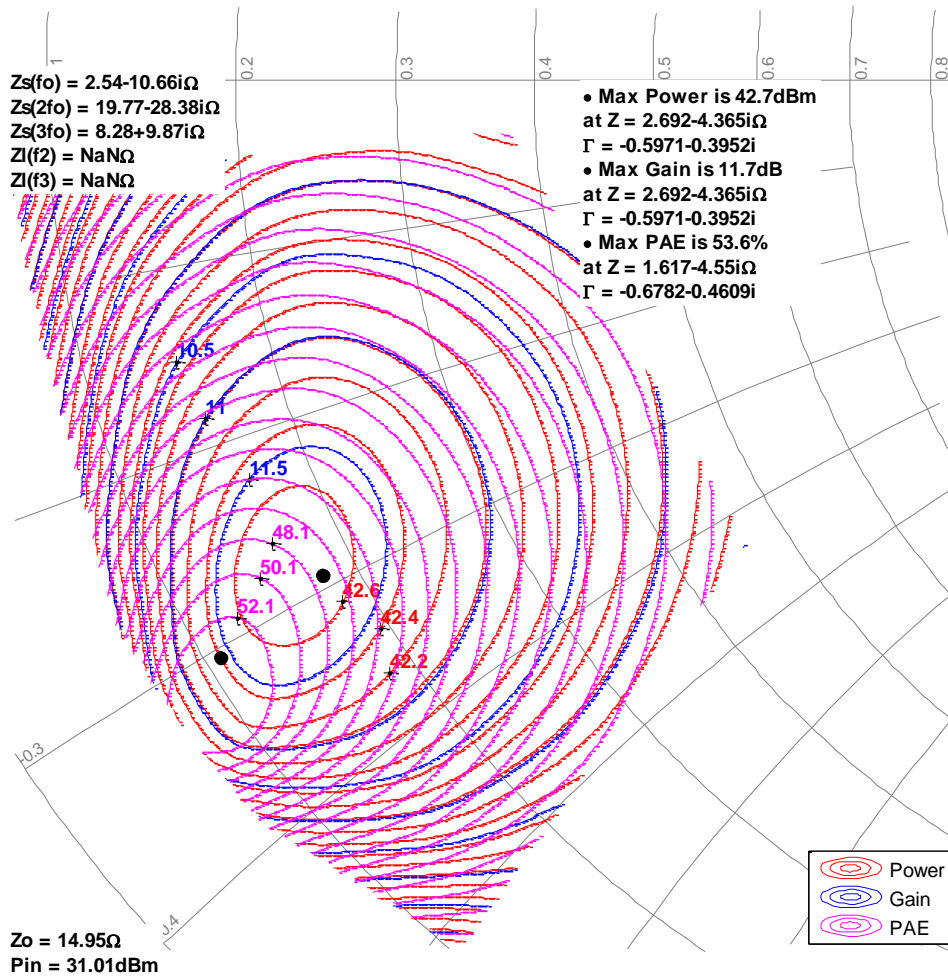

Load Pull Smith Charts – Pulsed^(1,2,3)

RF performance that the device typically exhibits when placed in the specified impedance environment. The impedances are not the impedances of the device, they are the impedances presented to the device via an RF circuit or load-pull system. The impedances listed follow an optimized trajectory to maintain high power and high efficiency.

Notes:

1. 32 V, 150 mA, Pulsed signal with 100 uS pulse width and 10 % duty cycle. Performance is at indicated input power.
2. See page 13 for load pull and source pull reference planes. 15-Ω load pull TRL fixtures are built with 10-mil RO4350B material.
3. NaN means the impedances are either undefined or varying in load-pull system.

9GHz, Load-pull

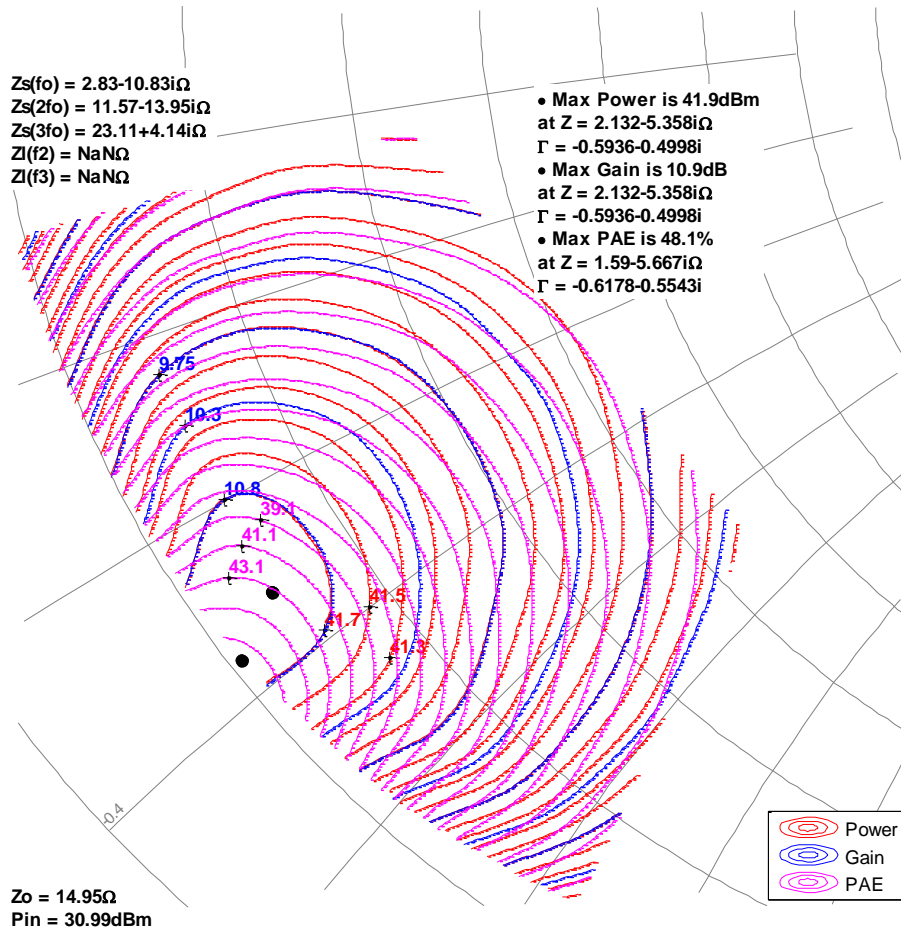

Load Pull Smith Charts – Pulsed^(1,2,3)

RF performance that the device typically exhibits when placed in the specified impedance environment. The impedances are not the impedances of the device, they are the impedances presented to the device via an RF circuit or load-pull system. The impedances listed follow an optimized trajectory to maintain high power and high efficiency.

Notes:

1. 32 V, 150 mA, Pulsed signal with 100 uS pulse width and 10 % duty cycle. Performance is at indicated input power.
2. See page 13 for load pull and source pull reference planes. 15-Ω load pull TRL fixtures are built with 10-mil RO4350B material.
3. NaN means the impedances are either undefined or varying in load-pull system.

9.4GHz, Load-pull

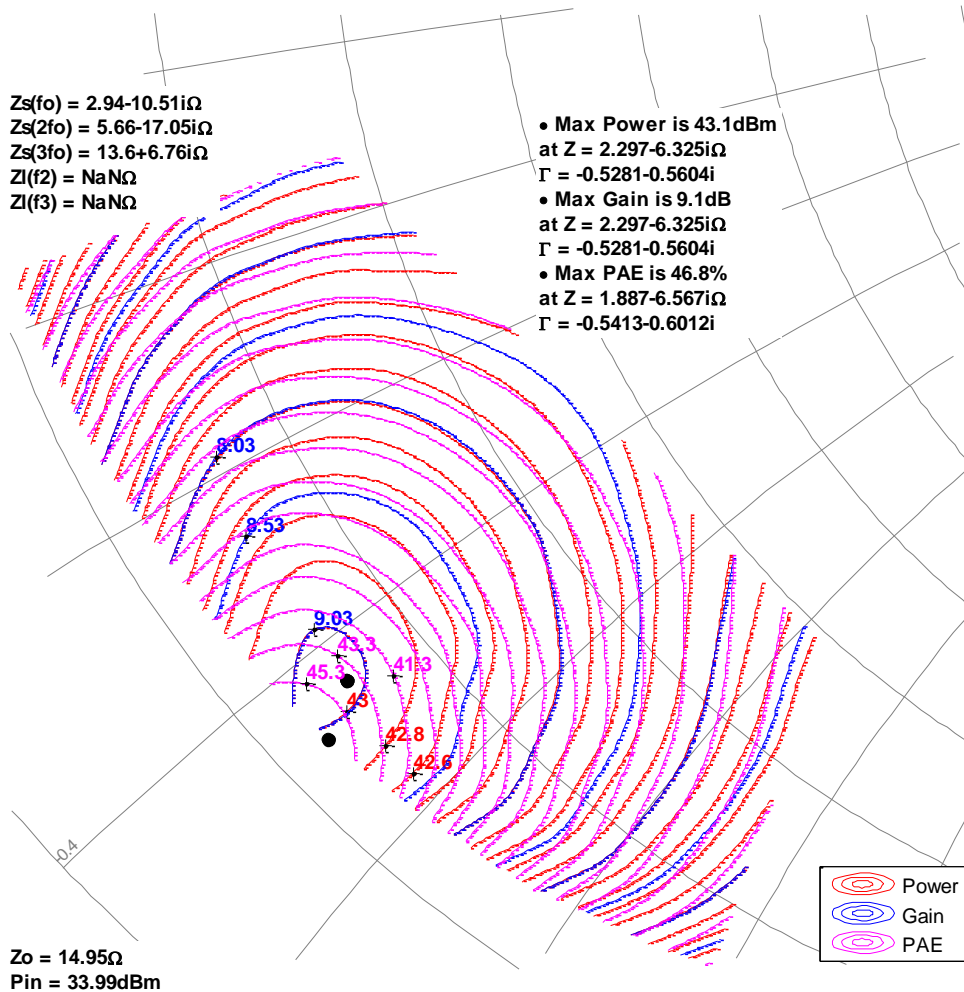

Load Pull Smith Charts – Pulsed^(1,2,3)

RF performance that the device typically exhibits when placed in the specified impedance environment. The impedances are not the impedances of the device, they are the impedances presented to the device via an RF circuit or load-pull system. The impedances listed follow an optimized trajectory to maintain high power and high efficiency.

Notes:

1. 32 V, 150 mA, Pulsed signal with 100 uS pulse width and 10 % duty cycle. Performance is at indicated input power.
2. See page 13 for load pull and source pull reference planes. 15-Ω load pull TRL fixtures are built with 10-mil RO4350B material.
3. NaN means the impedances are either undefined or varying in load-pull system.

10GHz, Load-pull

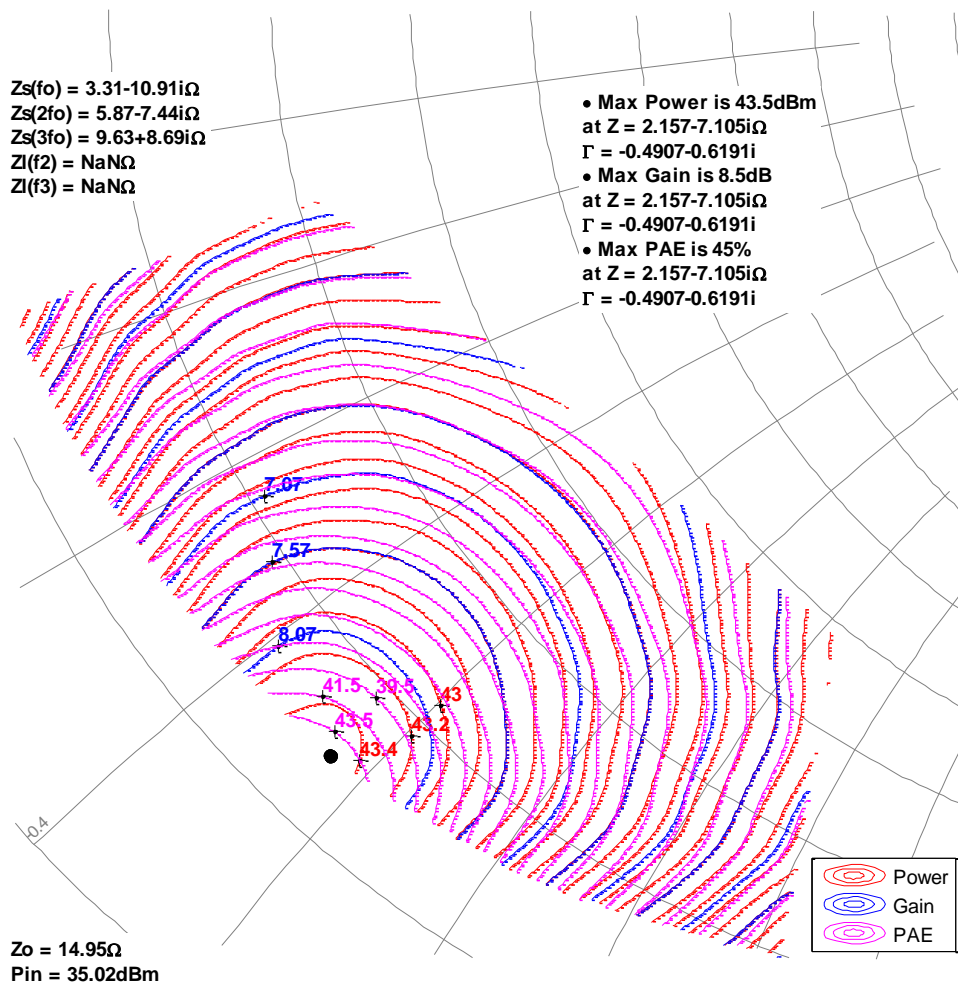

Load Pull Smith Charts – Pulsed^(1,2,3)

RF performance that the device typically exhibits when placed in the specified impedance environment. The impedances are not the impedances of the device, they are the impedances presented to the device via an RF circuit or load-pull system. The impedances listed follow an optimized trajectory to maintain high power and high efficiency.

Notes:

1. 32 V, 150 mA, Pulsed signal with 100 uS pulse width and 10 % duty cycle. Performance is at indicated input power.
2. See page 13 for load pull and source pull reference planes. 15-Ω load pull TRL fixtures are built with 10-mil RO4350B material.
3. NaN means the impedances are either undefined or varying in load-pull system.

12GHz, Load-pull

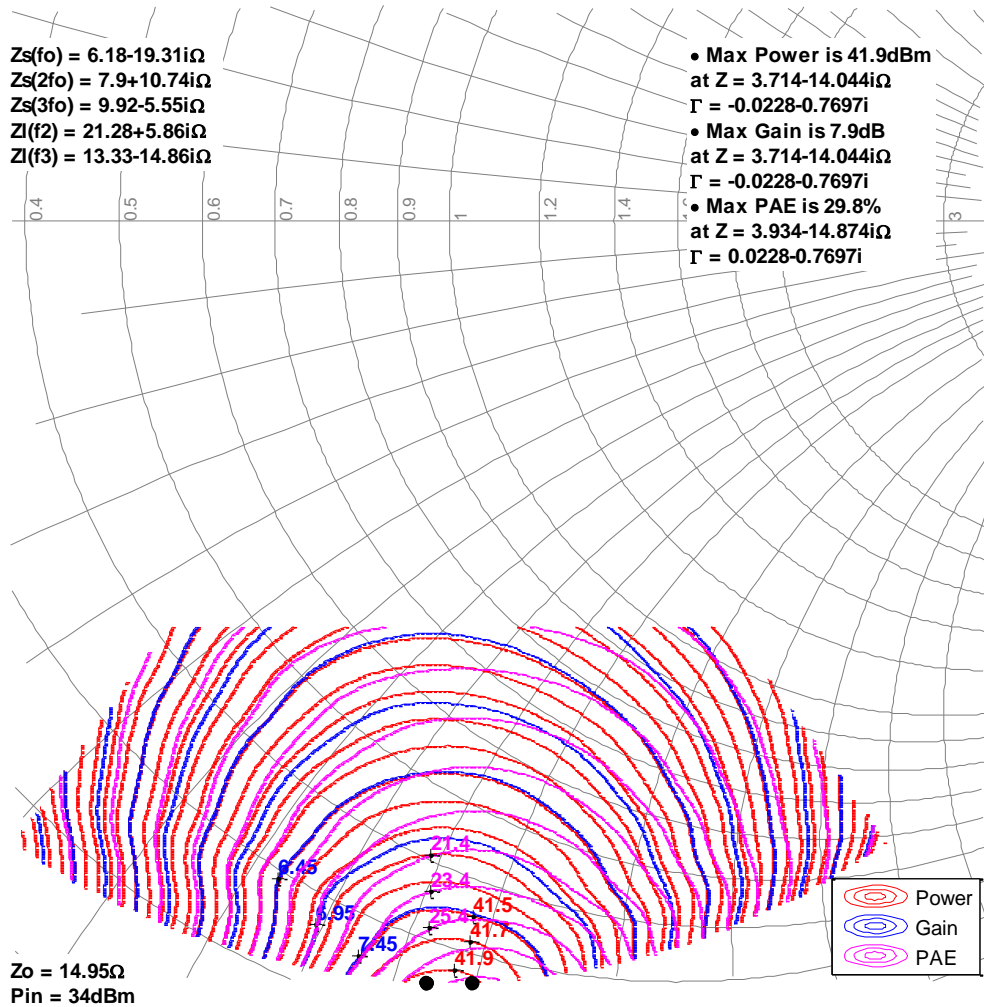

Typical Pulsed Performance – Power Tuned^(1,2)

Notes:

1. Pulsed signal with 100uS pulse width and 10% duty cycle
2. See page 13 for load pull and source pull reference planes where the performance was measured.

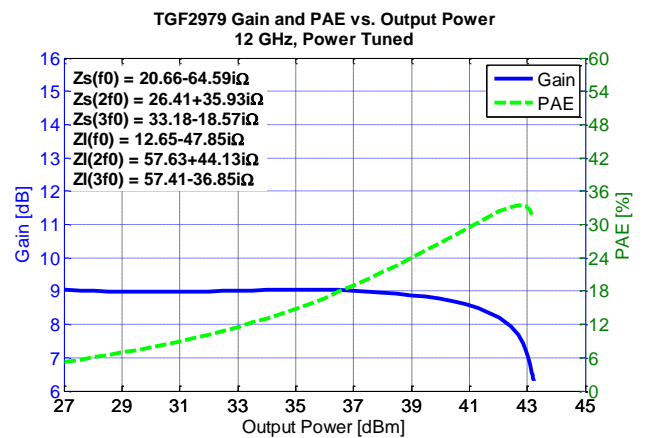
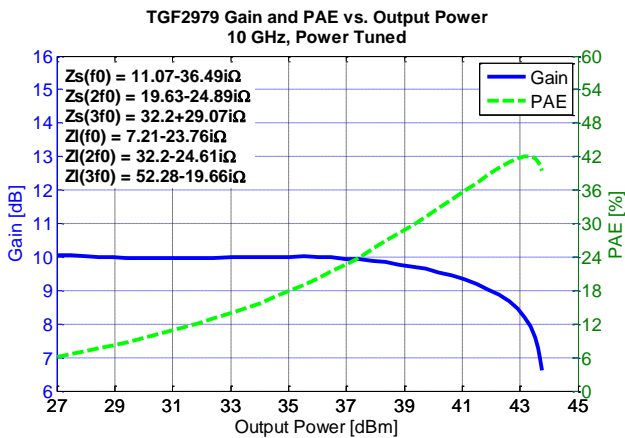
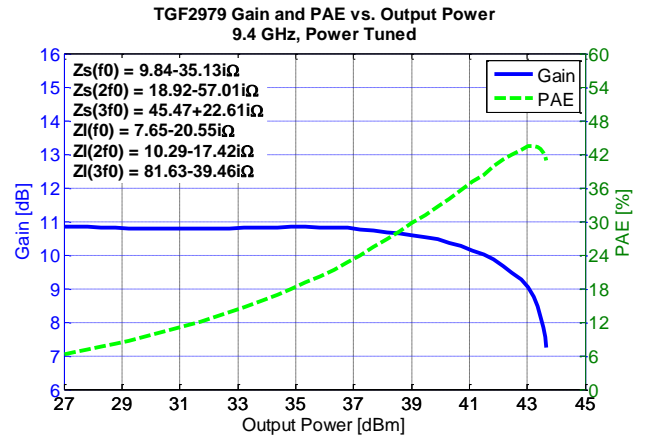
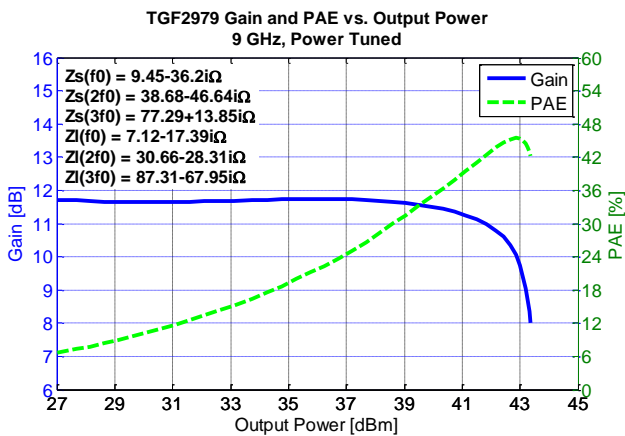
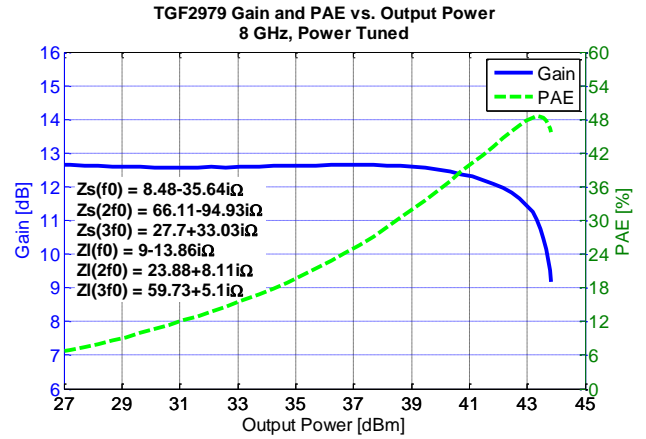
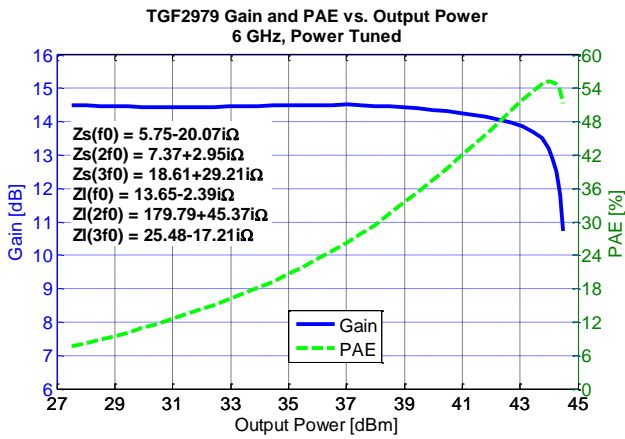

Typical Pulsed Performance – Efficiency Tuned^(1,2)

Notes:

1. Pulsed signal with 100uS pulse width and 10% duty cycle
2. See page 13 for load pull and source pull reference planes where the performance was measured.

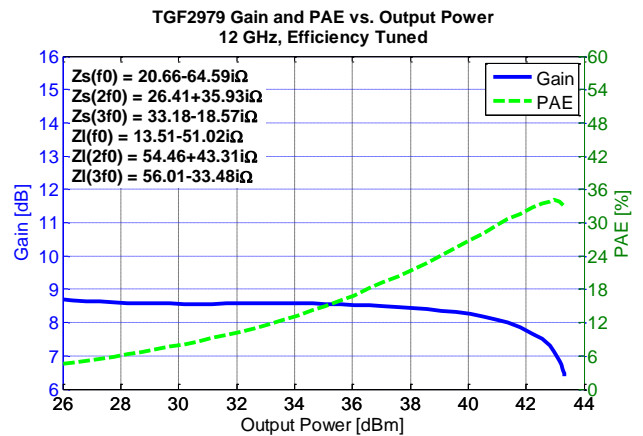
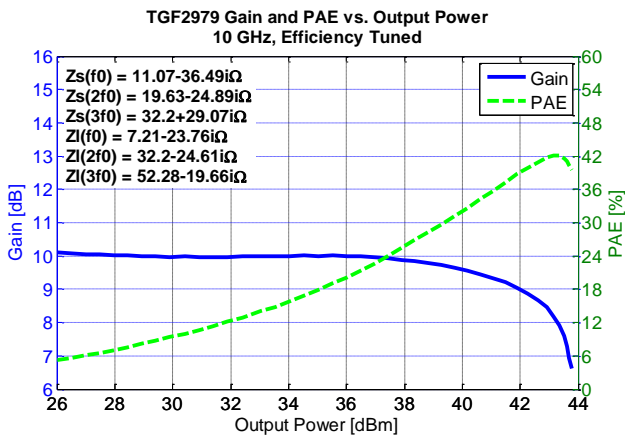
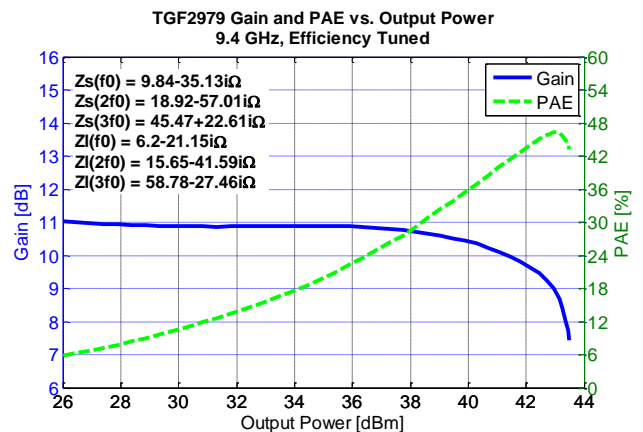
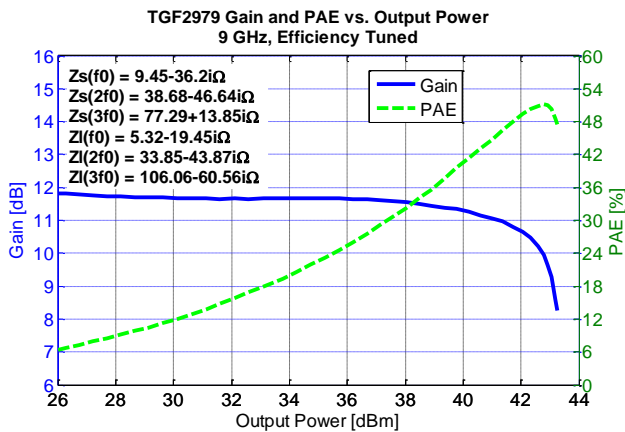
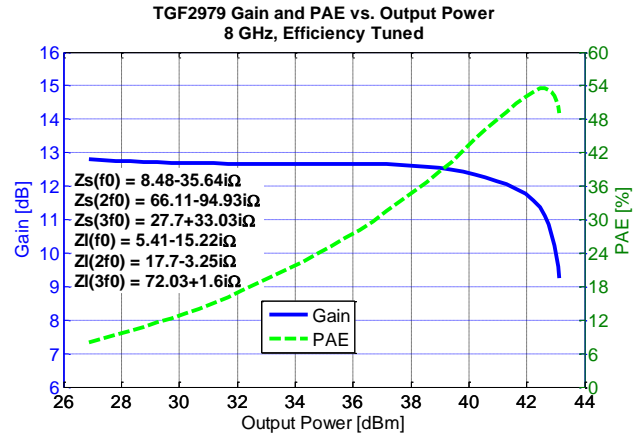
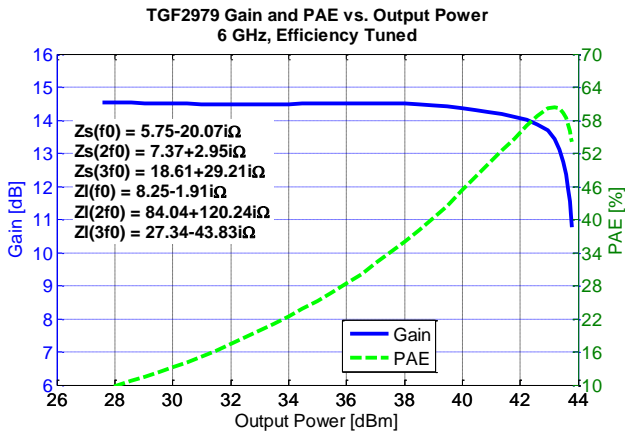

Pin Layout

Marking: Qorvo Logo
 Part Number – TGF2979-SM (The TGF2979-SM will be marked with the “2979” designator)
 Date Code – YYWW
 Lot Code – MZZZ

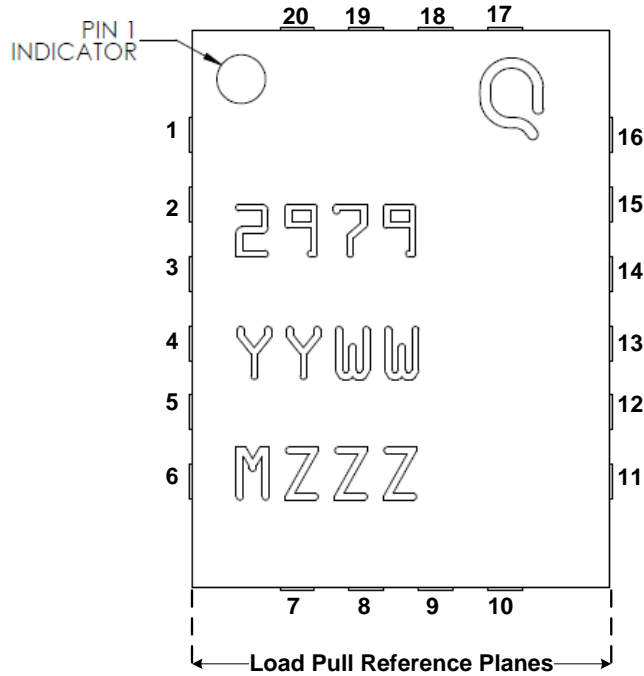

Pin Description

| Pin | Symbol | Description |
|-----------------|---------------|---|
| 11 – 16 | V_D /RF OUT | Drain voltage / RF Output to be matched to 50 ohms; |
| 1 – 6 | V_G /RF IN | Gate voltage / RF Input to be matched to 50 ohms; see |
| 7 – 10, 17 – 20 | N/C | Not connected |
| Back side | Source | Source connected to ground |

Mechanical Information

All dimensions are in millimeters.

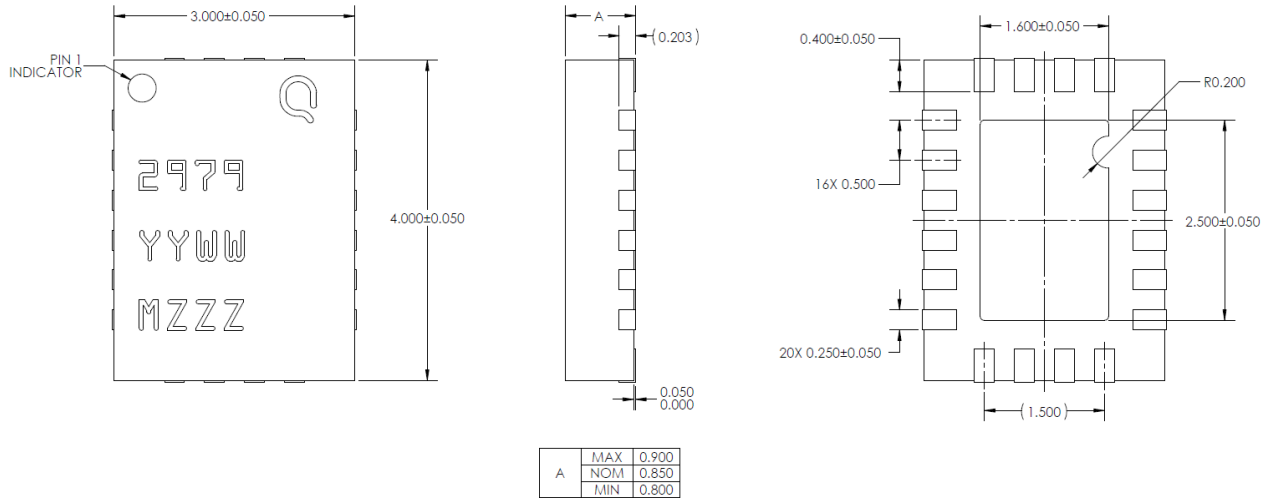

Note:

1. Unless otherwise noted, all dimension tolerances are ± 0.127 mm.
2. This package is lead-free/RoHS-compliant. The plating material on the leads is NiAu. It is compatible with both lead-free (maximum 260 °C reflow temperature) and tin-lead (maximum 245°C reflow temperature) soldering processes.

Recommended Solder Temperature Profile

