

## DC - 30 GHz Wideband Analog Attenuator

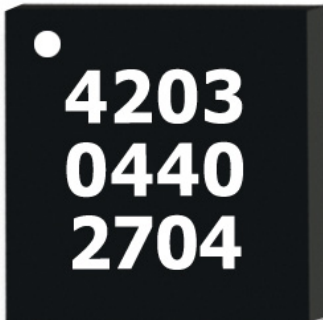

### Measured Performance

Bias conditions: -1V to 0V

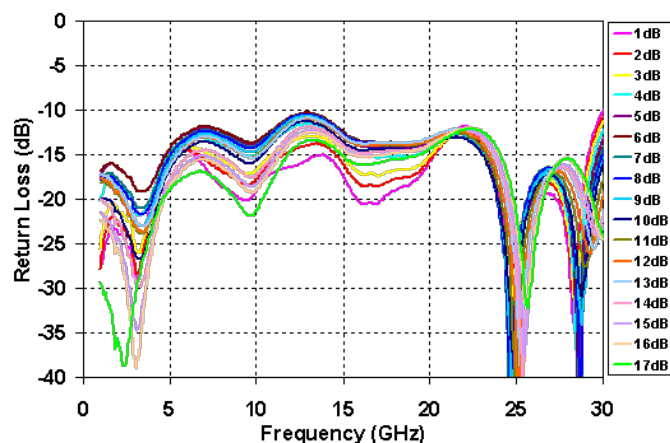
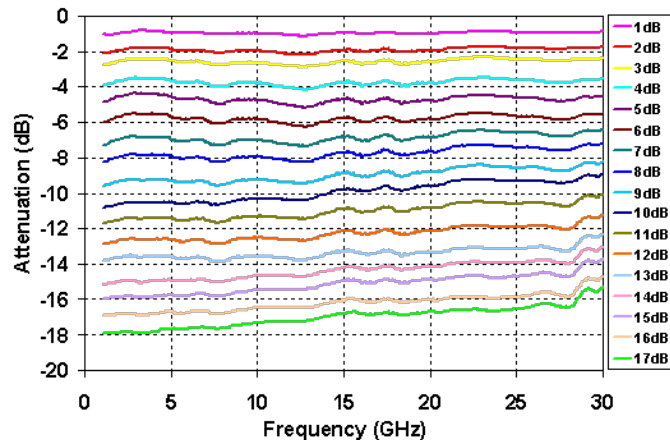

### Key Features

- Frequency Range: DC to 30 GHz
- 17 dB Variable Attenuation Range
- Insertion Loss: 1.5 dB Typical
- Input P1dB: >20 dBm Typical @ 10 dB Attenuation
- IM3: -40 dBc Typical @ Pin/Tone = 6dBm,
- Return Loss: 15 dB Typical
- Bias: -1V to 0 V
- Technology: 3MI 0.25 um mmw pHEMT
- Compact 3x3 QFN with 16 Leads
- Package Dimensions: 3 x 3 x 0.9 mm

### Primary Applications

- Point-to-Point Radio
- Fiber Optic
- Wideband Military & Space

### Product Description

The TriQuint TGL4203-SM is a wideband packaged Analog Attenuator. The TGL4203-SM operates from DC - 30 GHz and is designed using TriQuint's proven standard 0.25 um mmw pHEMT production process.

The TGL4203-SM typically provides 1.5 dB Insertion Loss, 17 dB variable Attenuation Range, >20 dBm Input Power @ 1dB compression Gain, -40 dBc IM3 @ 6 dBm Pin/Tone, with bias voltages from -1V to 0V.

The TGL4203-SM is available in a low-cost, compact surface mount 3x3 QFN style package with 16 leads. The wideband capabilities of this device are versatile in many applications such as Point to Point Radio, Fiber Optic, and Wideband Military & Space.

Evaluation Boards are available upon request.

Lead-free and RoHS compliant.

*Datasheet subject to change without notice.*

**Table I**  
**Absolute Maximum Ratings 1/**

Symbol	Parameter	Value	Notes
V1, V2	Attenuation Control Voltage Range	-5 to +1 V	
I1	V1 Supply Current	-1 to +8.8 mA	
I2	V2 Supply Current	-3 to +80 mA	
Pin	Input Continuous Wave Power	24 dBm	
Tchannel	Channel Temperature	200 °C	

1/ These ratings represent the maximum operable values for this device. Stresses beyond those listed under "Absolute Maximum Ratings" may cause permanent damage to the device and / or affect device lifetime. These are stress ratings only, and functional operation of the device at these conditions is not implied.

**Table II**  
**Recommended Operating Conditions**

Attenuation	V1 (V)	V2 (V)
REF	0.000	-1.000
1dB	-0.500	-0.877
2dB	-0.651	-0.840
3dB	-0.685	-0.817
4dB	-0.718	-0.784
5dB	-0.734	-0.752
6dB	-0.767	-0.725
7dB	-0.800	-0.703
8dB	-0.822	-0.681
9dB	-0.843	-0.648
10dB	-0.869	-0.623
11dB	-0.871	-0.577
12dB	-0.881	-0.518
13dB	-0.888	-0.447
14dB	-0.920	-0.387
15dB	-0.936	-0.311
16dB	-0.952	-0.147
17dB	-1.000	0.000

Bias Voltages Optimized for flatness of Attenuation with respect to reference over frequency

**Table III**  
**RF Characterization Table**

**Bias: -1 V to 0 V, (T<sub>A</sub> = 25 °C Nominal)**

<b>SYMBOL</b>	<b>PARAMETER</b>	<b>TEST CONDITIONS</b>	<b>MIN</b>	<b>NOM</b>	<b>MAX</b>	<b>UNITS</b>
	Attenuation Range	DC to 20 GHz 20 – 30 GHz	13 10	16 15	19 20	dB
IL	Insertion Loss	DC to 20 GHz 20 – 30 GHz		2 3.5	3 4.5	dB
IP1dB	Input Power @ 1dB Gain compression @ 10 dB Atten.	5 to 30 GHz		20		dBm
IM3	3rd Harmonic Intermodulation @ Pin/Tone = 6dBm	5 to 30 GHz		-40		dBc
IRL	Input Return Loss	DC to 30 GHz		15		dB
ORL	Output Return Loss	DC to 30 GHz		15		dB
	Group Delay Variation	DC to 30 GHz		+/-5		psec
	Max. Insertion Loss Ripple	DC to 30 GHz		0.5		dB
	Insertion Loss Temperature Coefficient	DC to 30 GHz		-0.01		dB/°C

**Table IV**  
**Power Dissipation and Thermal Properties**

Parameter	Test Conditions	Value	Notes
Maximum Input Power		Pin = 250 mW Tchannel = 150 °C Tm = 1.0E+6 Hrs	1/ 2/
Thermal Resistance, $\theta_{jc}$	Pin = 100 mW Tbaseplate = 70 °C	$\theta_{jc}$ = 42 (°C/W) Tchannel = 74.2 °C Tm = 2.4E+9 Hrs	
Mounting Temperature	30 seconds	260 °C Max	
Storage Temperature		-65 to 150 °C	

1/ For a median life of 1E+6 hours, Input Power is limited to

$$P_{in} = (150\text{ °C} - T_{base}\text{ °C})/\theta_{jc}$$

2/ Channel operating temperature will directly affect the device median time (Tm). For maximum life, it is recommended that channel temperatures be maintained at the lowest possible levels.

### Median Lifetime (Tm) vs. Channel Temperature

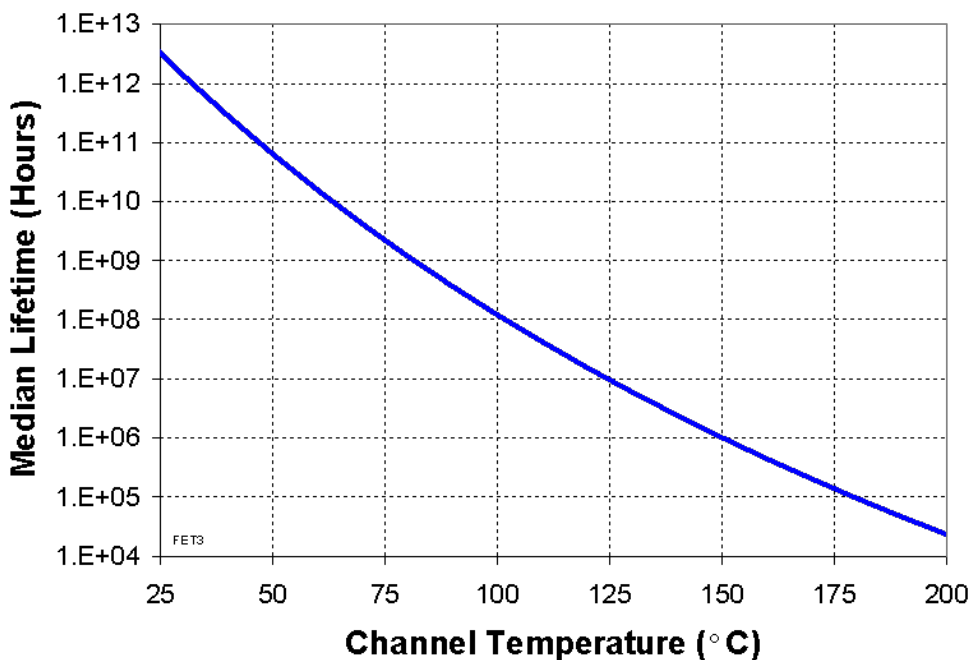

**Measured Data**

See Table II for Recommended Bias V1 & V2, ( $T_A = 25\text{ }^\circ\text{C}$  Nominal)

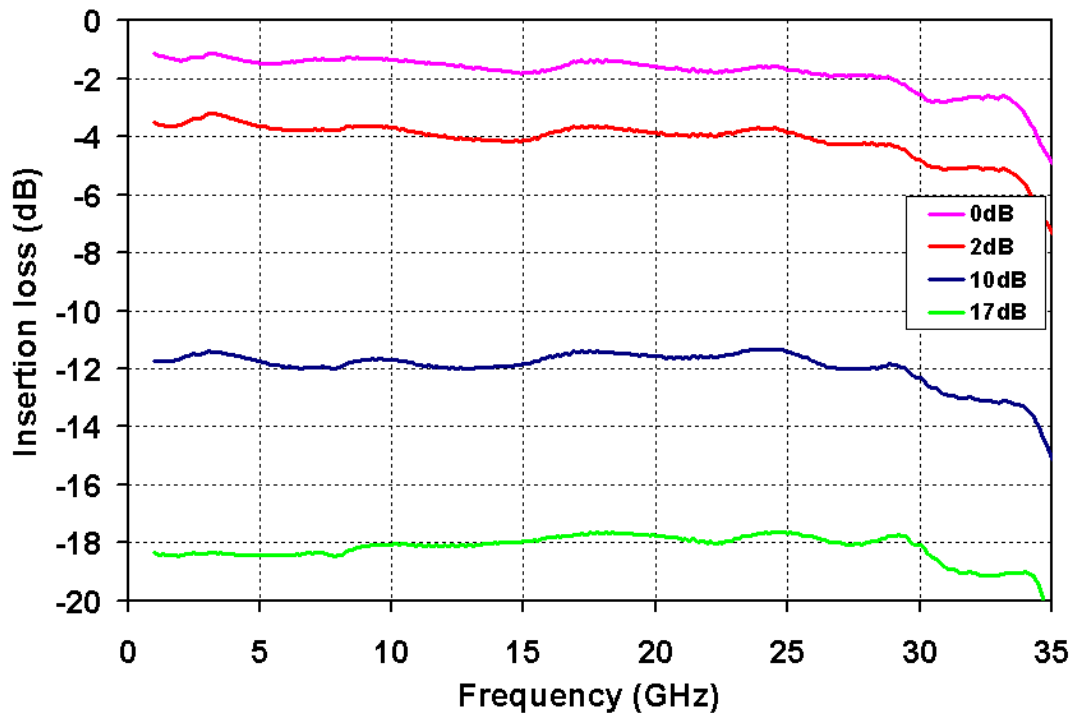
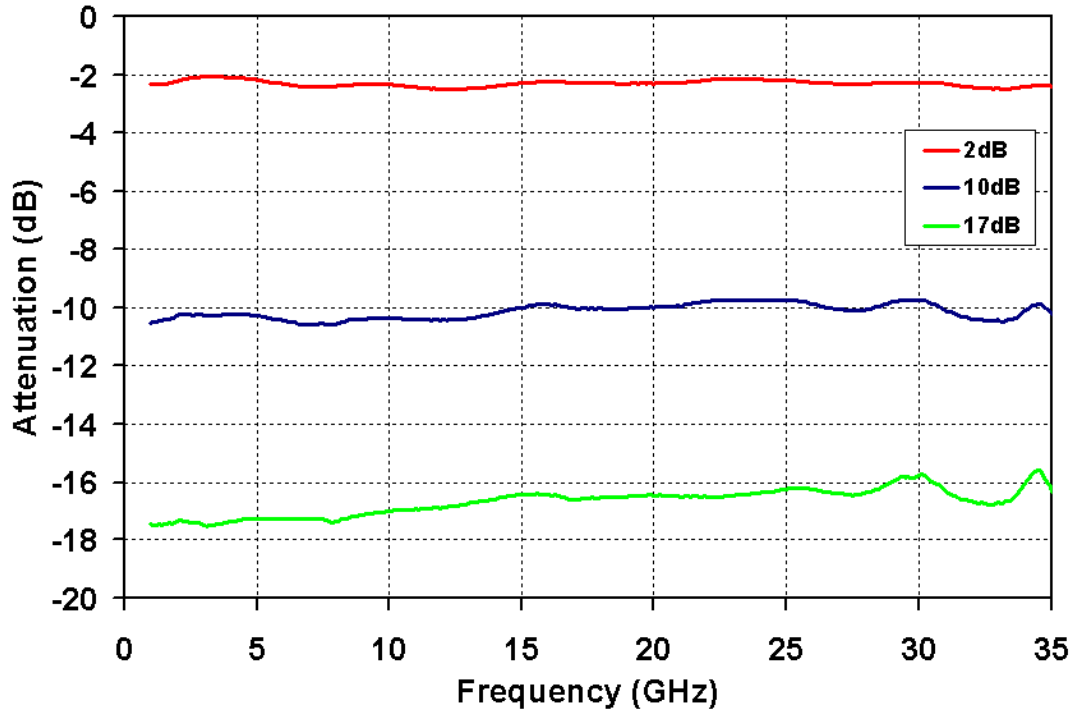

**Measured Data**

See Table II for Recommended Bias V1 & V2 , ( $T_A = 25^\circ\text{C}$  Nominal)

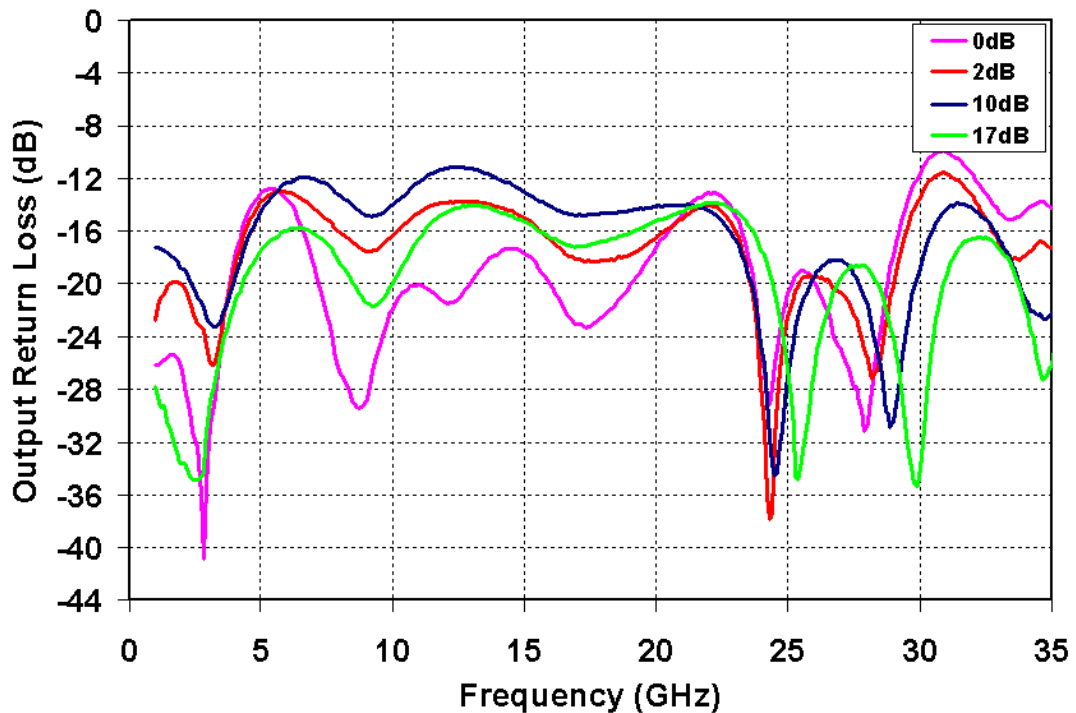
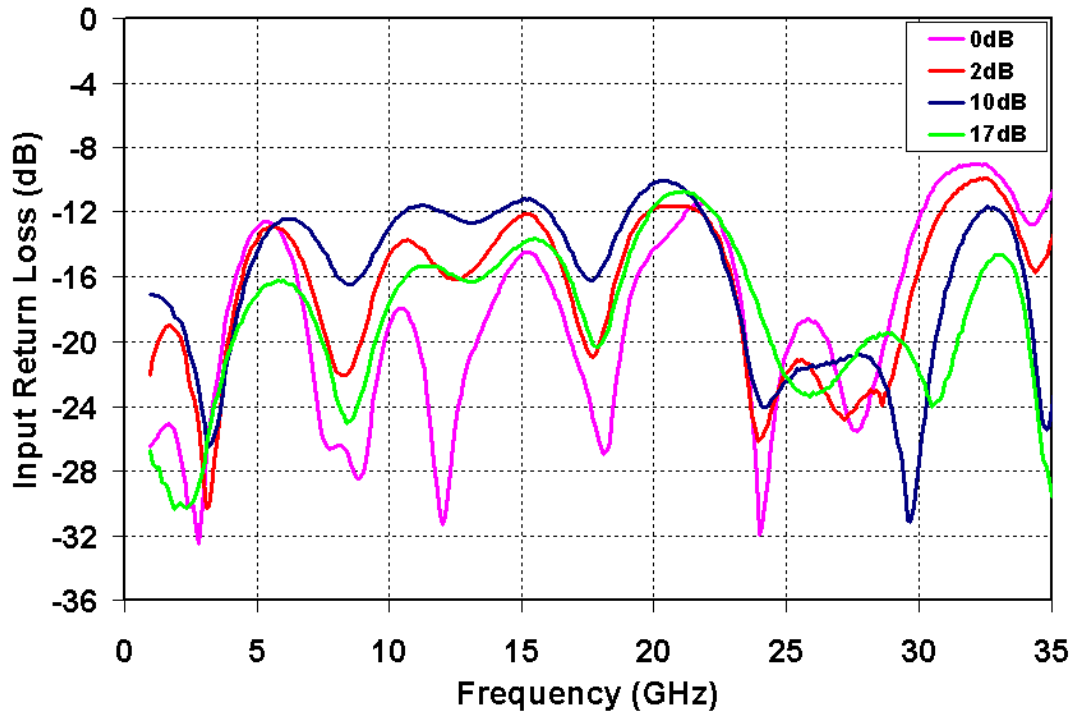

**Measured Data**

See Table II for Recommended Bias V1 & V2 , ( $T_A = 25^\circ\text{C}$  Nominal)

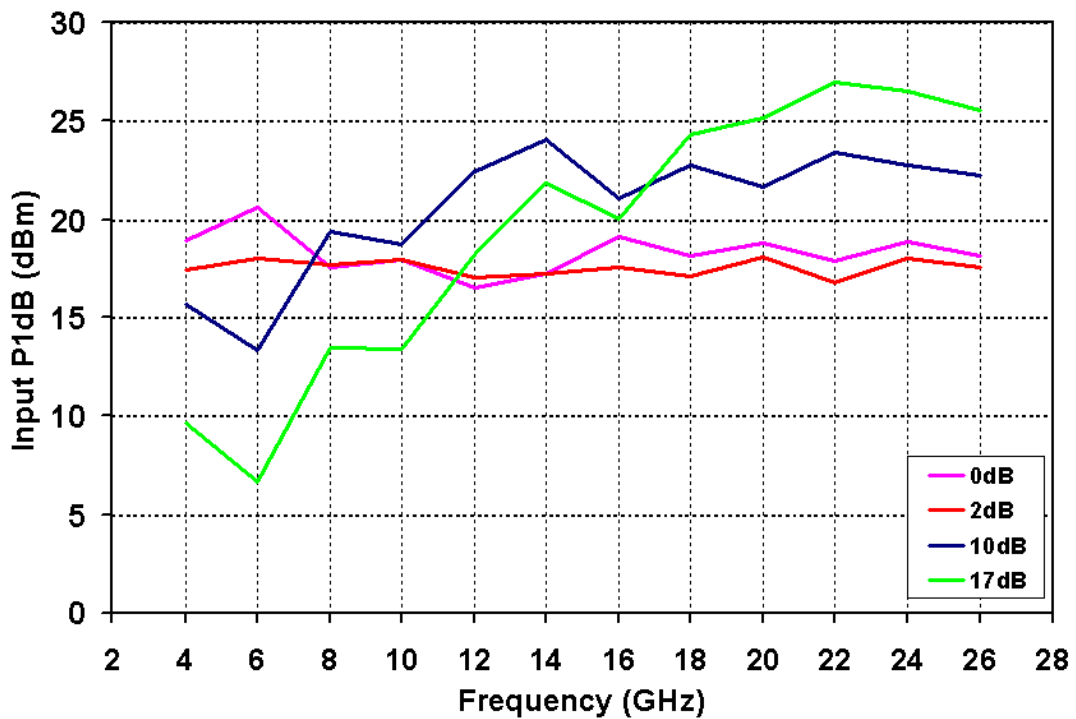
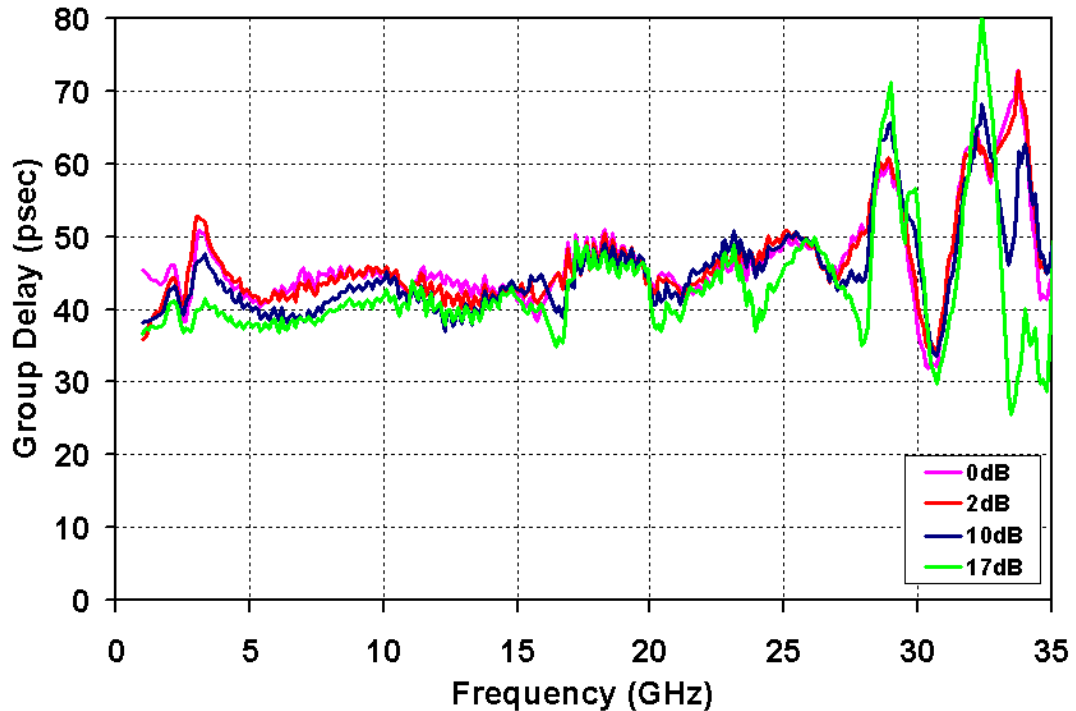

**Measured Data**

See Table II for Recommended Bias V1 & V2 , ( $T_A = 25\text{ }^\circ\text{C}$  Nominal)

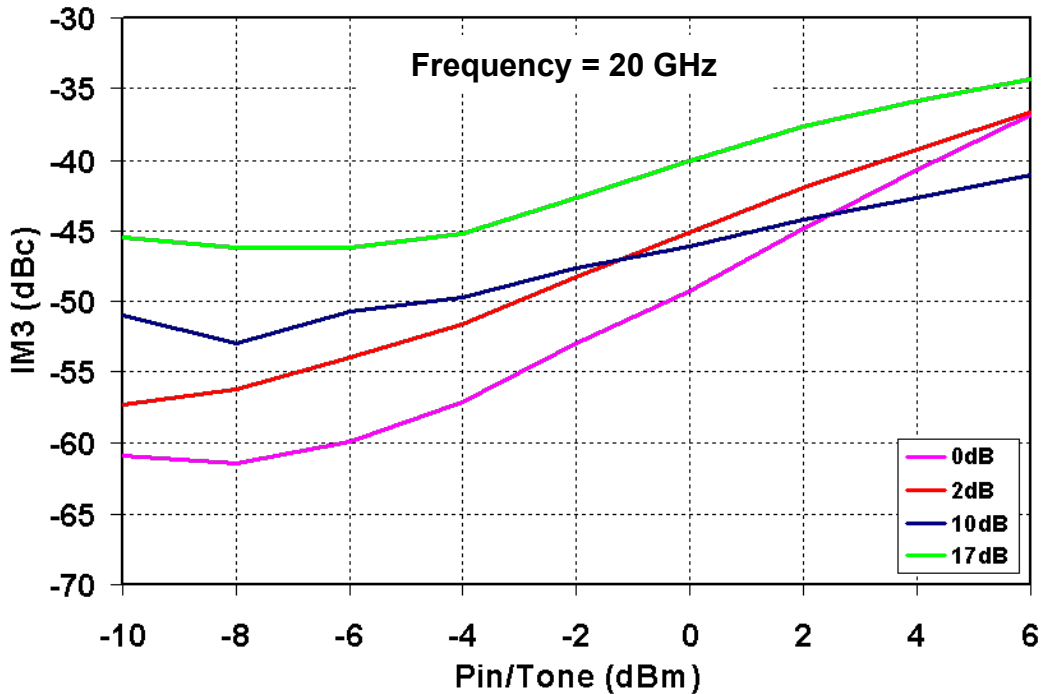
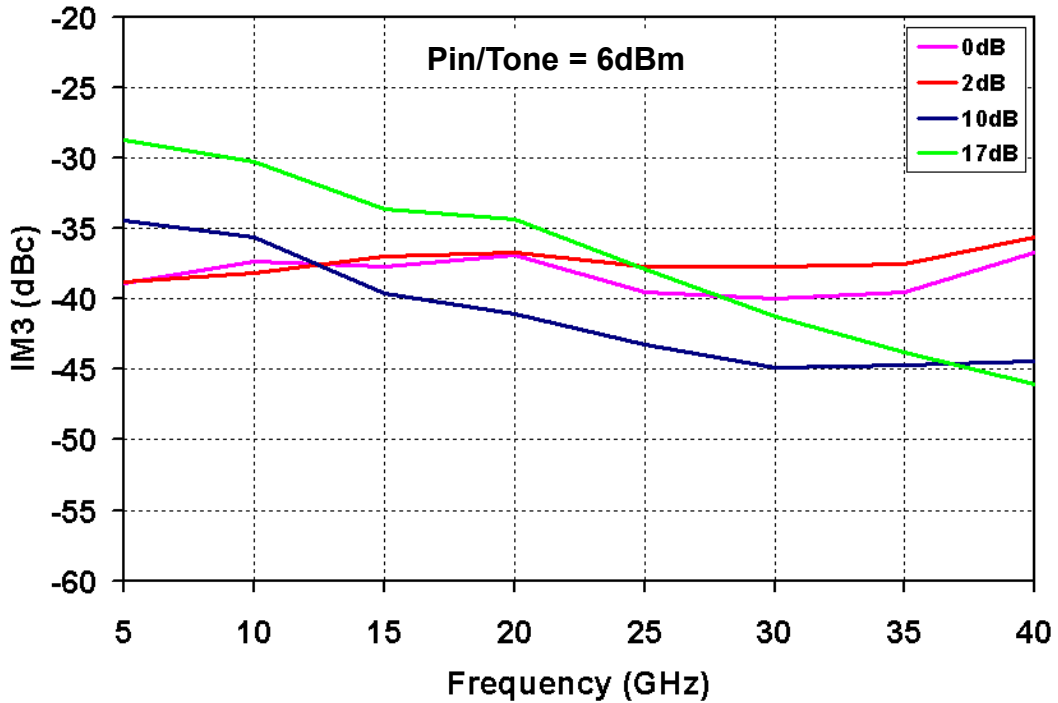



**Measured Data**

See Table II for Recommended Bias V1 & V2  
Data include connectors and TL losses

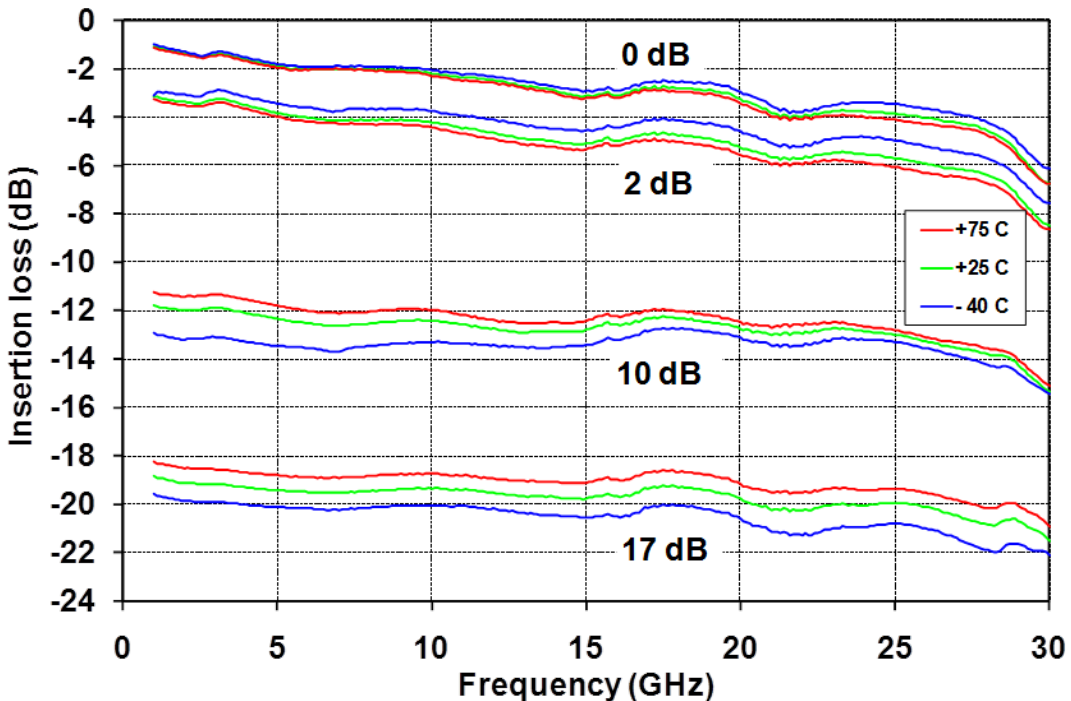
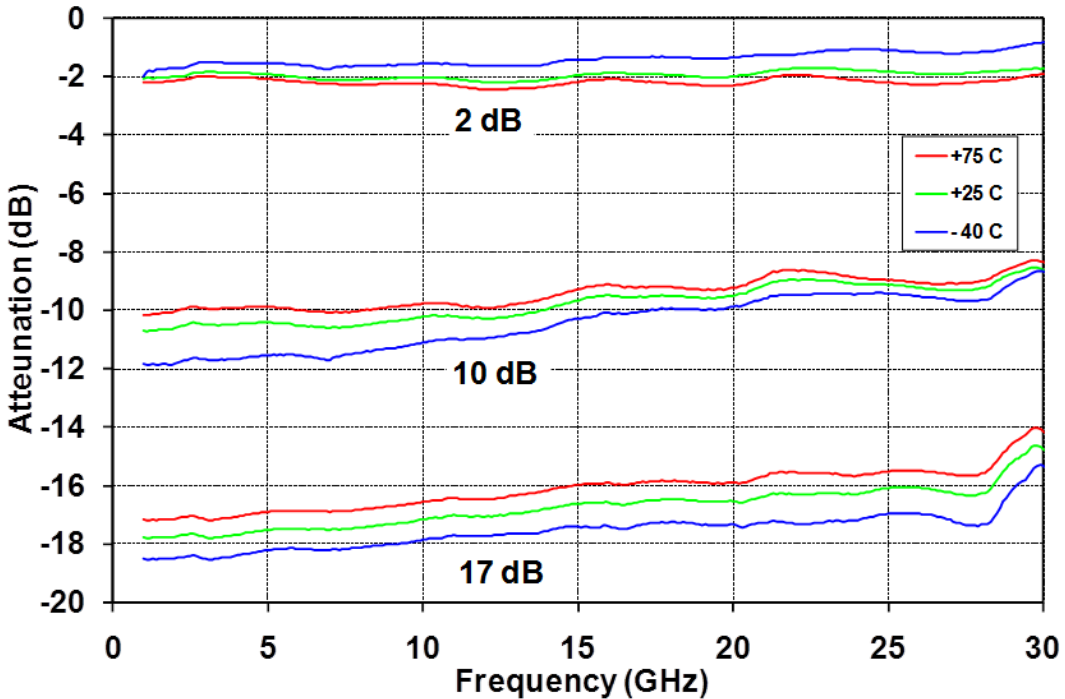

**Measured Data**

See Table II for Recommended Bias V1 & V2

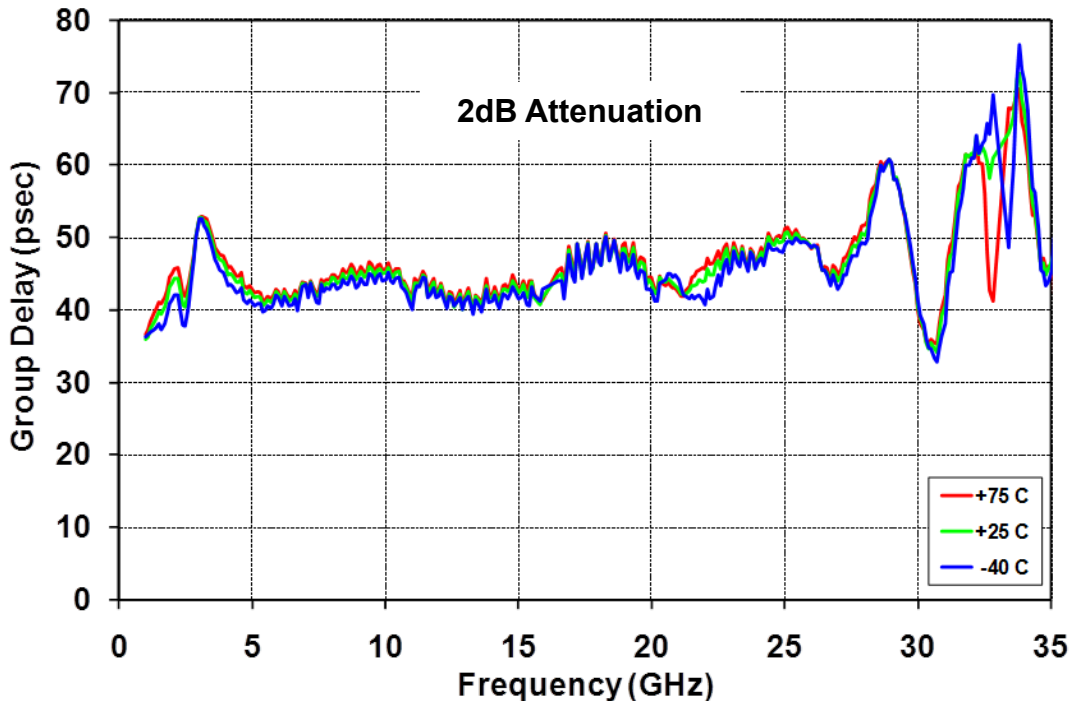
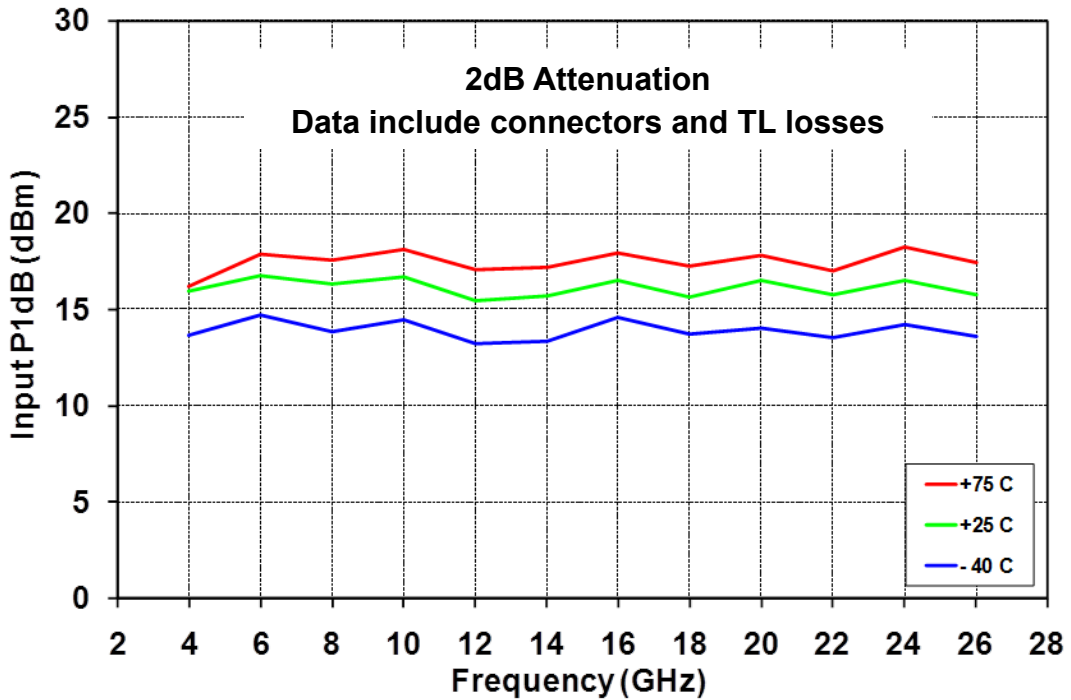

## Electrical Schematic

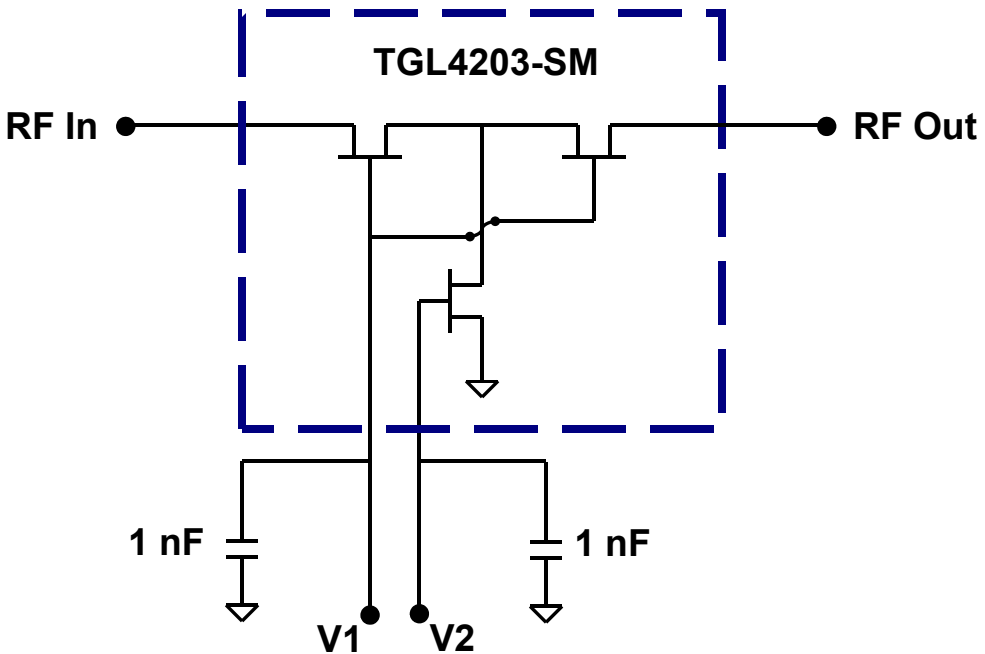

## Bias Procedures

### Bias-up Procedure

- V1 & V2 set to 0V
- Adjust V1 & V2 more negative according to Table II
- Apply RF (max. input level +24dBm)

### Bias-down Procedure

- Turn off RF
- Set V1 & V2 to 0V

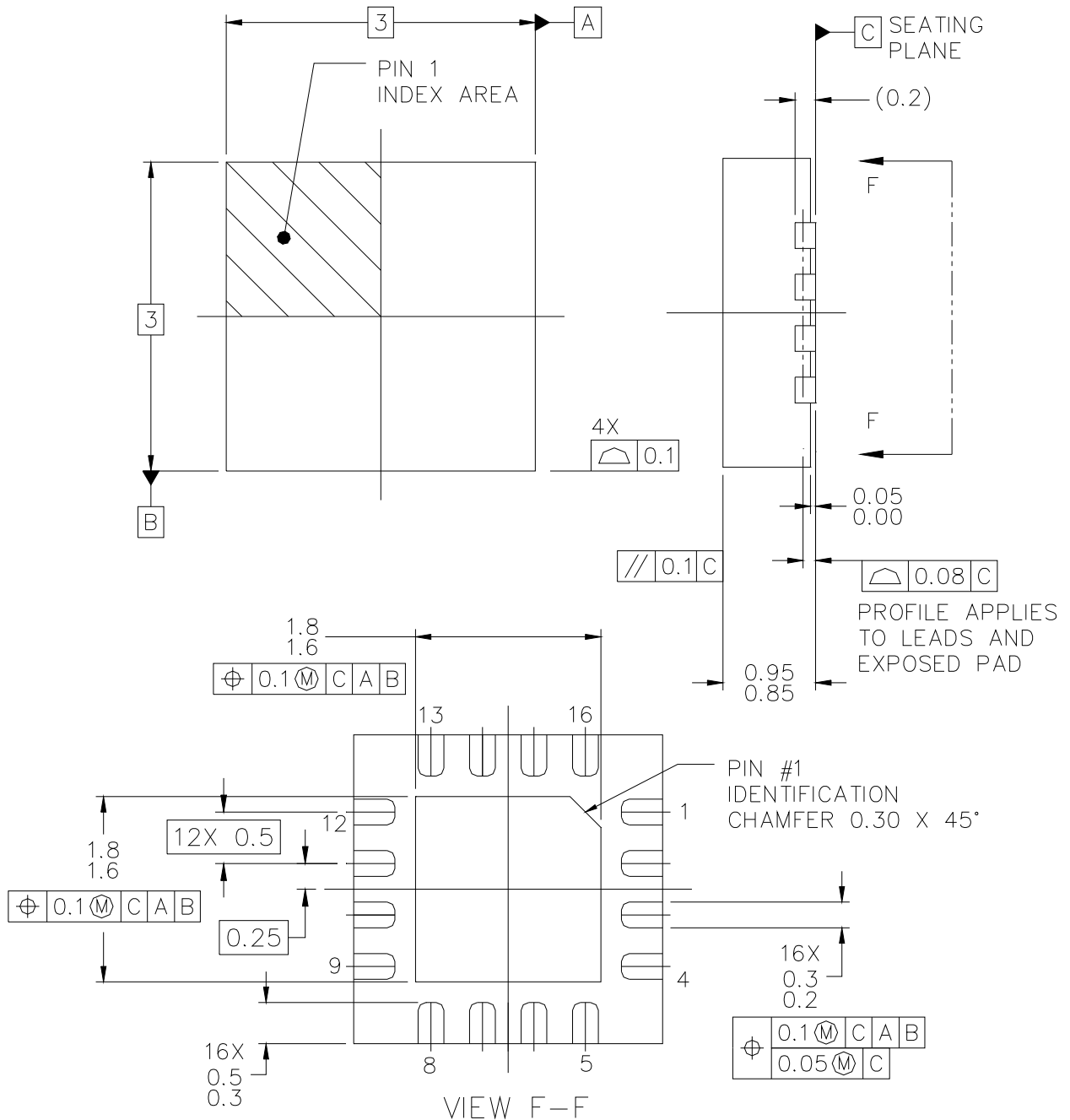

**RF In & RF Out can be reversed**

Pin	Description
1, 2, 4, 9, 11, 12	GND
3	RF In
5, 8, 13, 14, 15, 16	N/C

Pin	Description
6	V1
7	V2
10	RF Out

**GaAs MMIC devices are susceptible to damage from Electrostatic Discharge. Proper precautions should be observed during handling, assembly and test.**

**Recommended Evaluation Board**

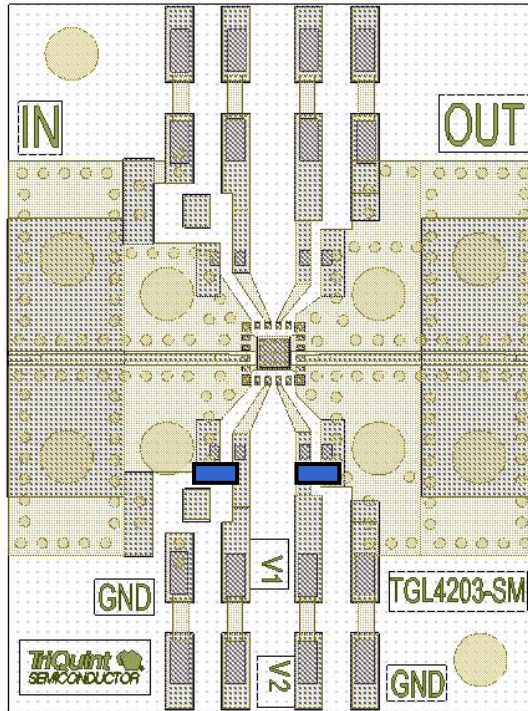

 1nF (size 0402) capacitors for DC decoupling

Board material is 8 mil ROGERS RO4003

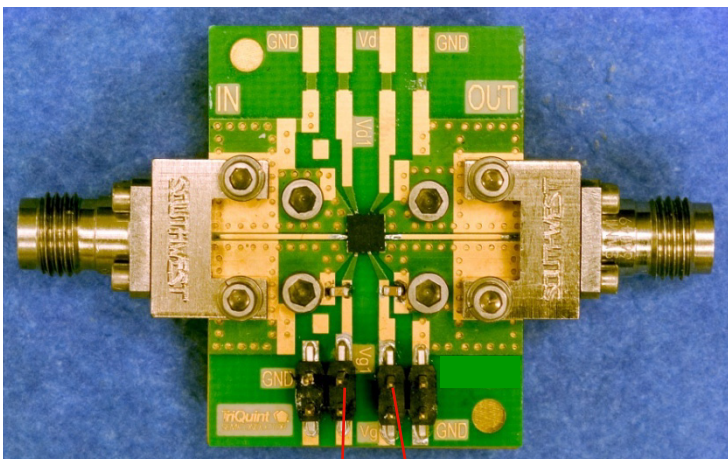

V1

V2

**GaAs MMIC devices are susceptible to damage from Electrostatic Discharge. Proper precautions should be observed during handling, assembly and test.**