

Product Description

Qorvo's TGP2102 is a 5-bit digital phase shifter MMIC design using Qorvo's proven 0.25 μm power pHEMT process to support a variety of Ka-Band phased array applications including military radar.

The 5-bit design utilizes a compact topology that achieves a 1.41 mm² die area and high performance. The TGP2102 provides a 5-bit digital phase shift function with a nominal 7 dB insertion loss and 5° RMS phase shift error over a bandwidth of 32 – 37 GHz.

The TGP2102 requires a minimum of off-chip components and operates with a -5 V control voltage. Each device is RF tested on-wafer to ensure performance compliance. The device is available in chip form.

The device is lead-free and RoHS compliant.



Product Features

- Frequency Range: 32 to 37 GHz
- 5-Bit Digital Phase Shifter
- RMS Phase Error: 3.5° @ 35 GHz
- RMS Amplitude Error: 0.4 dB @ 35 GHz
- Insertion Loss: 7 dB
- Return Loss: 14 dB IRL; 7 dB ORL
- Negative Control Voltage: -5/0 V
- Single-Ended logic
- CMOS Compatible
- Chip Dimensions: 1.88 x 0.75 x 0.10 mm

Performance is typical across frequency. Please reference electrical specification table and data plots for more details

Functional Block Diagram

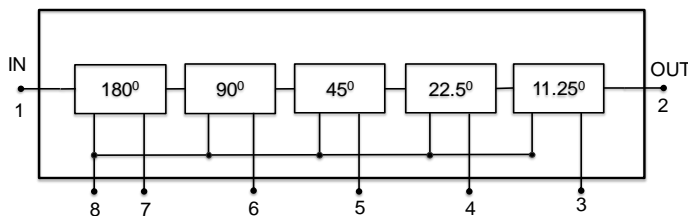

Applications

- Military Radar
- Transit / Receive
- Massive MIMO

Ordering Information

Part No.	Description
TGP2102	32-37 GHz 5 Bit Digital Phase Shifter, Waffle Pack 25 pieces

Absolute Maximum Ratings

Parameter	Value
Control and Supply Voltages	-8 V
Control Current	1 mA
Power Dissipation	0.1 W
Input Power, CW	20 dBm
Channel Temperature	150 °C
Mounting Temperature (30 Seconds)	320 °C
Storage Temperature	-65 to 150 °C

Operation of this device outside the parameter ranges given above may cause permanent damage. These are stress ratings only, and functional operation of the device at these conditions is not implied. Extended application of Absolute Maximum Rating conditions may reduce device reliability.

Recommended Operating Conditions

Parameter	Value
Control Voltage (V_C)	-5/0 V
Reference Voltage (V_{SUPPLY})	-5 V
Operating Temperature Range	-40 to +85 °C

Electrical specifications are measured at specified test conditions. Specifications are not guaranteed overall operating conditions.

Electrical Specifications

Test conditions unless otherwise noted: 25°C. $V_{SUPPLY} = -5 V$, $V_C = -5/0 V$; see State Table.

Parameter	Min	Typical	Max	Units
Operational Frequency Range	32		37	GHz
Insertion Loss		7		dB
Input Return Loss		14		dB
Output Return Loss		7		dB
Peak Phase Shift Error		5		deg
RMS Phase Shift Error		4		deg
Peak Amplitude Error		1		dB
RMS Amplitude Error		0.7		dB

Notes: The data are from the typical devices as determined by fixtured measurements.



TGP2102

35 GHz 5-Bit Digital Phase Shifter

State Table

State	V-Supply	V-11.25	V-22.5	V-45	V-90	V-180	Phase Shift
0	-5V	0V	0V	0V	0V	0V	Reference
1	-5V	-5V	0V	0V	0V	0V	11.25°
2	-5V	0V	-5V	0V	0V	0V	22.5°
3	-5V	-5V	-5V	0V	0V	0V	33.75°
4	-5V	0V	0V	-5V	0V	0V	45°
5	-5V	-5V	0V	-5V	0V	0V	56.25°
6	-5V	0V	-5V	-5V	0V	0V	67.5°
7	-5V	-5V	-5V	-5V	0V	0V	78.75°
8	-5V	0V	0V	0V	-5V	0V	90°
9	-5V	-5V	0V	0V	-5V	0V	101.25°
10	-5V	0V	-5V	0V	-5V	0V	112.5°
11	-5V	-5V	-5V	0V	-5V	0V	123.75°
12	-5V	0V	0V	-5V	-5V	0V	135°
13	-5V	-5V	0V	-5V	-5V	0V	146.25°
14	-5V	0V	-5V	-5V	-5V	0V	157.5°
15	-5V	-5V	-5V	-5V	-5V	0V	168.75°
16	-5V	0V	0V	0V	0V	0V	180°
17	-5V	-5V	0V	0V	0V	-5V	191.25°
18	-5V	0V	-5V	0V	0V	-5V	202.5°
19	-5V	-5V	-5V	0V	0V	-5V	213.75°
20	-5V	0V	0V	-5V	0V	-5V	225°
21	-5V	-5V	0V	-5V	0V	-5V	236.25°
22	-5V	0V	-5V	-5V	0V	-5V	247.5°
23	-5V	-5V	-5V	-5V	0V	-5V	258.75°
24	-5V	0V	0V	0V	-5V	-5V	270°
25	-5V	-5V	0V	0V	-5V	-5V	281.25°
26	-5V	0V	-5V	0V	-5V	-5V	292.5°
27	-5V	-5V	-5V	0V	-5V	-5V	303.75°
28	-5V	0V	0V	-5V	-5V	-5V	315°
29	-5V	-5V	0V	-5V	-5V	-5V	326.25°
30	-5V	0V	-5V	-5V	-5V	-5V	337.5°
31	-5V	-5V	-5V	-5V	-5V	-5V	348.75°

Performance Plots – All States

Test conditions unless otherwise noted: 25 °C

Insertion Loss vs. Frequency

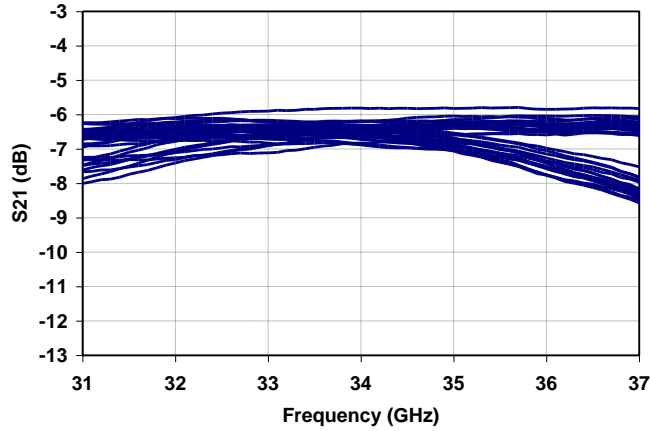

Input Return Loss vs. Frequency

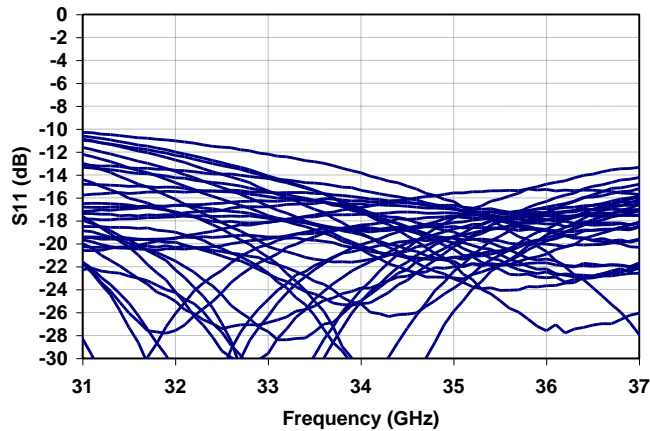

Output Return Loss vs. Frequency

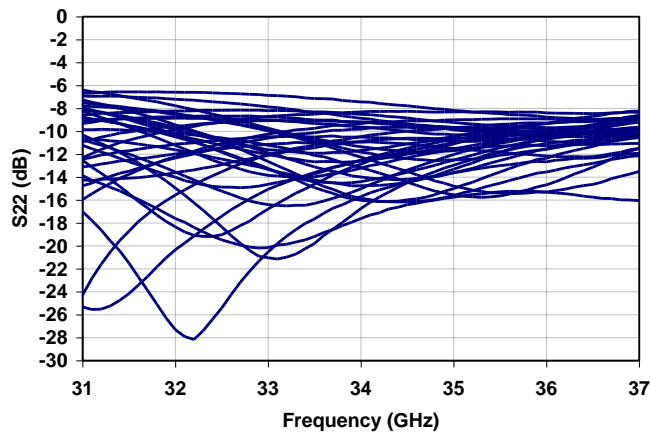

Performance Plots –

Test conditions unless otherwise noted: 25 °C

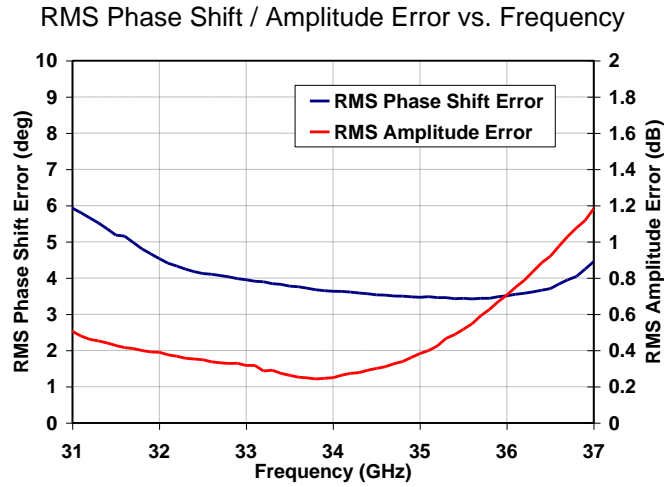

Phase Error vs. State

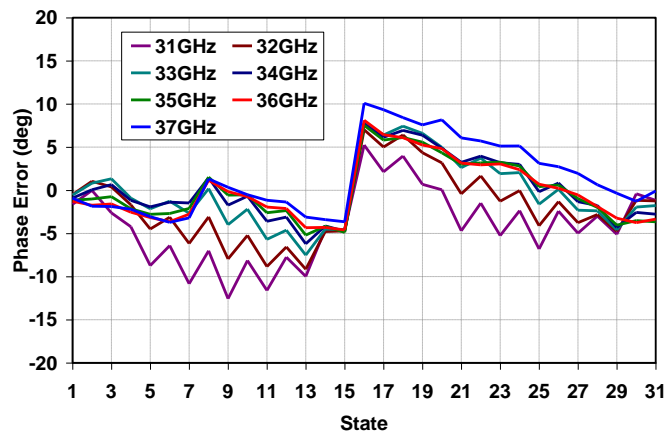

Amplitude Error vs. State

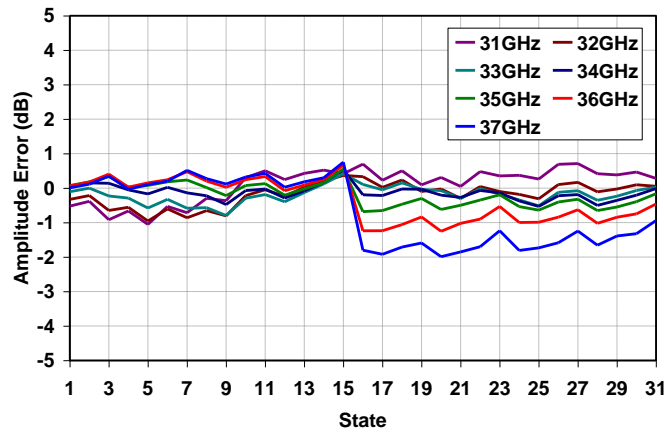

Die Assembly & Bonding Diagram

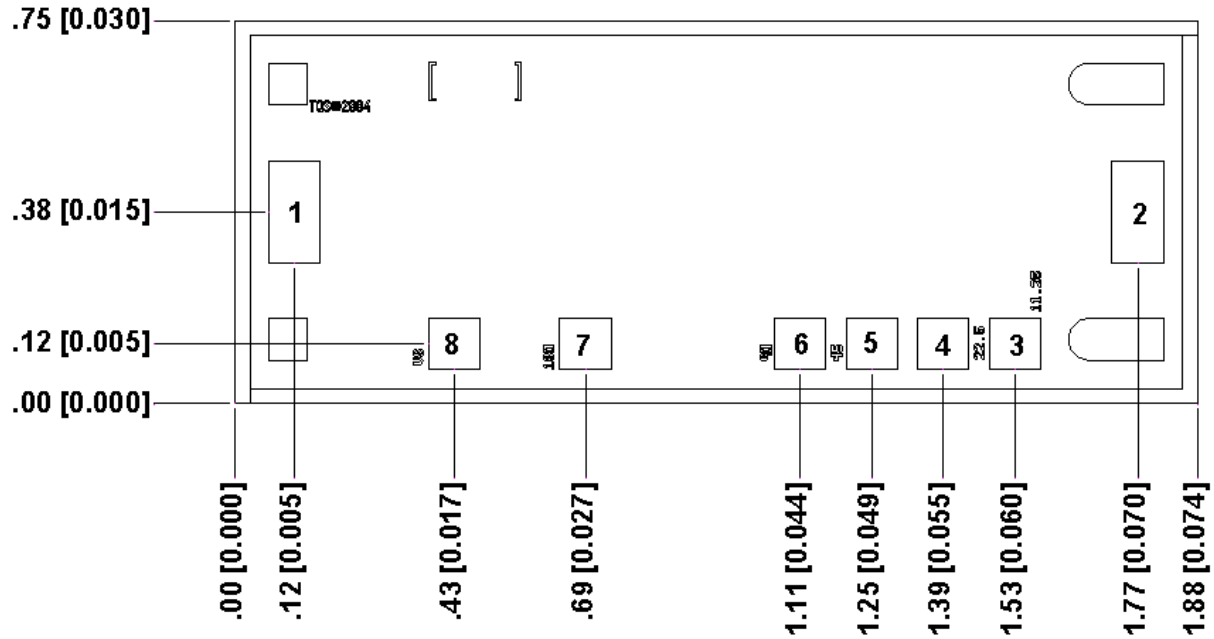

Unit: millimeters (inches)
 Thickness: 0.10 [0.004] (reference only)
 Chip edge to bond pad dimensions are shown to center of bond pads
 Chip size tolerance: ± 0.05 [0.002]
 RF ground through backside

Bond Pad	Symbol	Pad Size(mm)	Pad Size[in]
1	RF Input	0.10 x 0.20	0.004 x 0.008
2	RF Output	0.10 x 0.20	0.004 x 0.008
3	V-11.25 (On V=-5V)	0.10 x 0.10	0.004 x 0.004
4	V-22.5 (On V=-5V)	0.10 x 0.10	0.004 x 0.004
5	V-45 (On V=-5V)	0.10 x 0.10	0.004 x 0.004
6	V-90 (On V=-5V)	0.10 x 0.10	0.004 x 0.004
7	V-180 (On V=-5V)	0.10 x 0.10	0.004 x 0.004
8	V-Supply (-5V)	0.10 x 0.10	0.004 x 0.004

Die Assembly & Bonding Diagram

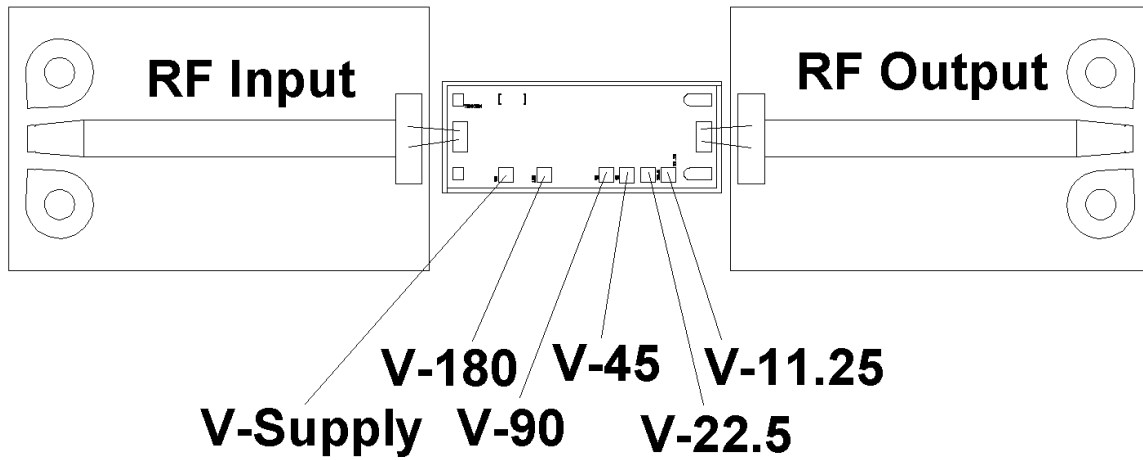

Notes:

1. Device were tested with 500 Ω resistors in series with control lines.
2. Input and output stubs are 0.007" x 0.024" on 0.010" alumina substrate.

Assembly Notes

Component placement and adhesive attachment assembly notes:

- Vacuum pencils and/or vacuum collets are the preferred method of pick up.
- Air bridges must be avoided during placement.
- The force impact is critical during auto placement.
- Organic attachment (i.e., conductive epoxy) can be used in low-power applications.
- Curing should be done in a convection oven; proper exhaust is a safety concern.
- Devices must be stored in a dry nitrogen atmosphere.

Reflow process assembly notes:

- Use AuSn (80/20) solder and limit exposure to temperatures above 300°C to 3-4 minutes, maximum.
- Conductive epoxy die attach is recommended for PCB mounting.
- Bonding pads plating: Au.
- An alloy station or conveyor furnace with reducing atmosphere should be used.
- Do not use any kind of flux.
- Coefficient of thermal expansion matching is critical for long-term reliability.
- Devices must be stored in a dry nitrogen atmosphere.

Interconnect process assembly notes:

- Thermosonic ball bonding is the preferred interconnect technique.
- Force, time, and ultrasonics are critical parameters.
- Aluminum wire should not be used.
- Devices with small pad sizes should be bonded with 0.0007-inch wire.

Thermal and Reliability Information

Parameter	Test Conditions	Value	Units
Channel Temperature, T_{CH} (Under RF)	$T_{BASEPLATE} = 85^{\circ}C$	85	$^{\circ}C$
Median Lifetime (T_M)		6.6E08	Hrs

Notes:

Under normal (lifetime) operating conditions, self-heating is not a significant contributor to channel temperature.

Median Lifetime

