



TAOGLAS®



Datasheet

TI.85.2113 868MHz Terminal Mount Dipole Antenna

Part No:
TI.85.2113

Description:
ISM 868MHz Terminal Dipole Antenna 2dBi SMA(M) Hinged

Features:
ISM 868MHz Band Operation
High Efficiency up to 76%
Hinged SMA (M) Connector
Height: 198mm
Diameter: 13mm
RoHS & Reach Compliant

1. Introduction	3
2. Specifications	4
3. Antenna Characteristics	6
4. Radiation Patterns	8
5. Mechanical Drawing	11
6. Packaging	12
<hr/>	
Changelog	13

Taoglas makes no warranties based on the accuracy or completeness of the contents of this document and reserves the right to make changes to specifications and product descriptions at any time without notice. Taoglas reserves all rights to this document and the information contained herein. Reproduction, use or disclosure to third parties without express permission is strictly prohibited. Copyright © Taoglas Ltd.



1. Introduction



The TI.85.2113 is a high performance 868MHz Terminal mount dipole antenna, it is 198mm tall and 13mm in diameter and can be mounted straight or right angled due to its hinged SMA(M) connector which comes as standard. This antenna performs very well in free space, making it an ideal solution in areas where there may be no ground plane.

Typical Applications include:

- Smart Metering
- Remote Monitoring
- Industrial IoT
- Connected Enterprise

The TI.85 is manufactured using TPEE which makes it very lightweight at just 22.5g. The swivel and hinge mechanism allows the antenna to be orientated in different directions which helps to avoid other antennas or objects. The antenna connector type can be customizable, please contact your regional Taoglas customer support team for installation guidelines or additional support to integrate and test this antenna's performance in your device.

2. Specifications

Electrical	
Frequency (MHz)	ISM 868
	860~870
Efficiency (%)	
Straight	75.17
Bent	76.72
Average Gain (dB)	
Straight	-1.24
Bent	-1.15
Peak Gain (dBi)	
Straight	1.31
Bent	2.04
Impedance	50 Ω
Polarization	Linear
Radiation Pattern	Omni
Max. input power	1W
Mechanical	
Height	198 ±3.3 mm
Planner Dimension	198*ø13 mm
Casing	TPEE
Connector	SMA(M)
Weight	22.5 g
Temperature Range	
Temperature Range	-40°C to 85°C
Humidity	
Humidity	Non-condensing 65°C 95% RH

3. Antenna Characteristics

3.1 Return Loss

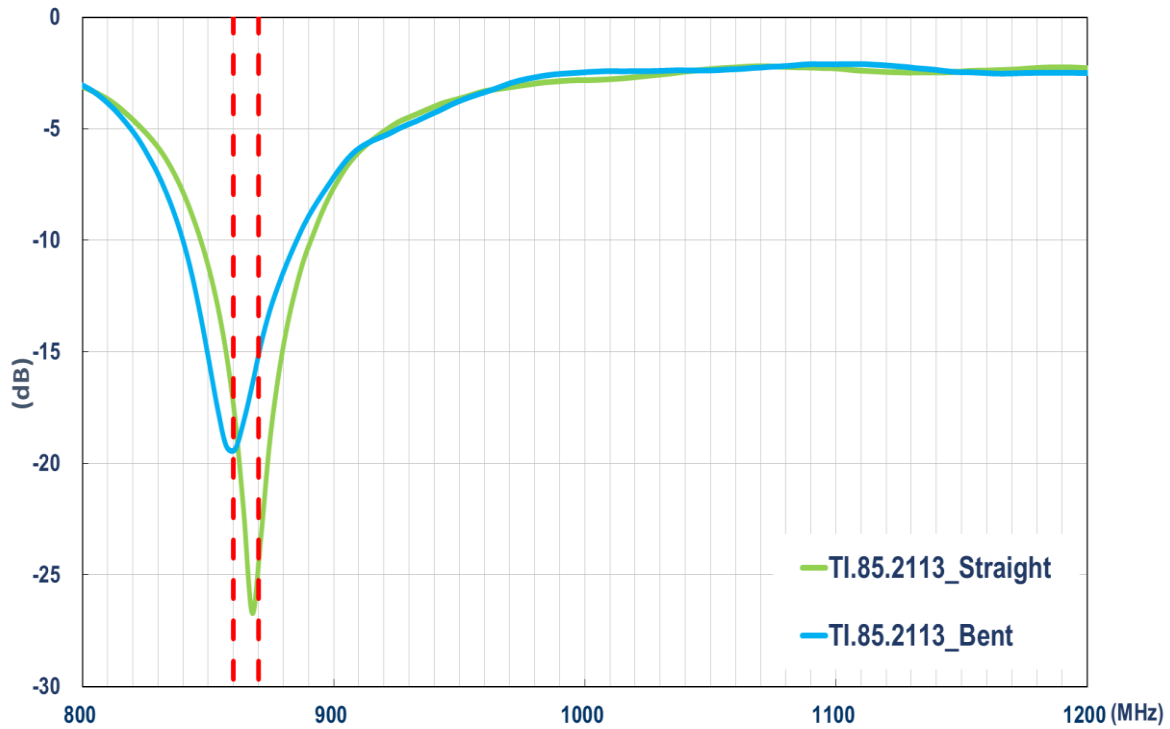

3.2 Efficiency

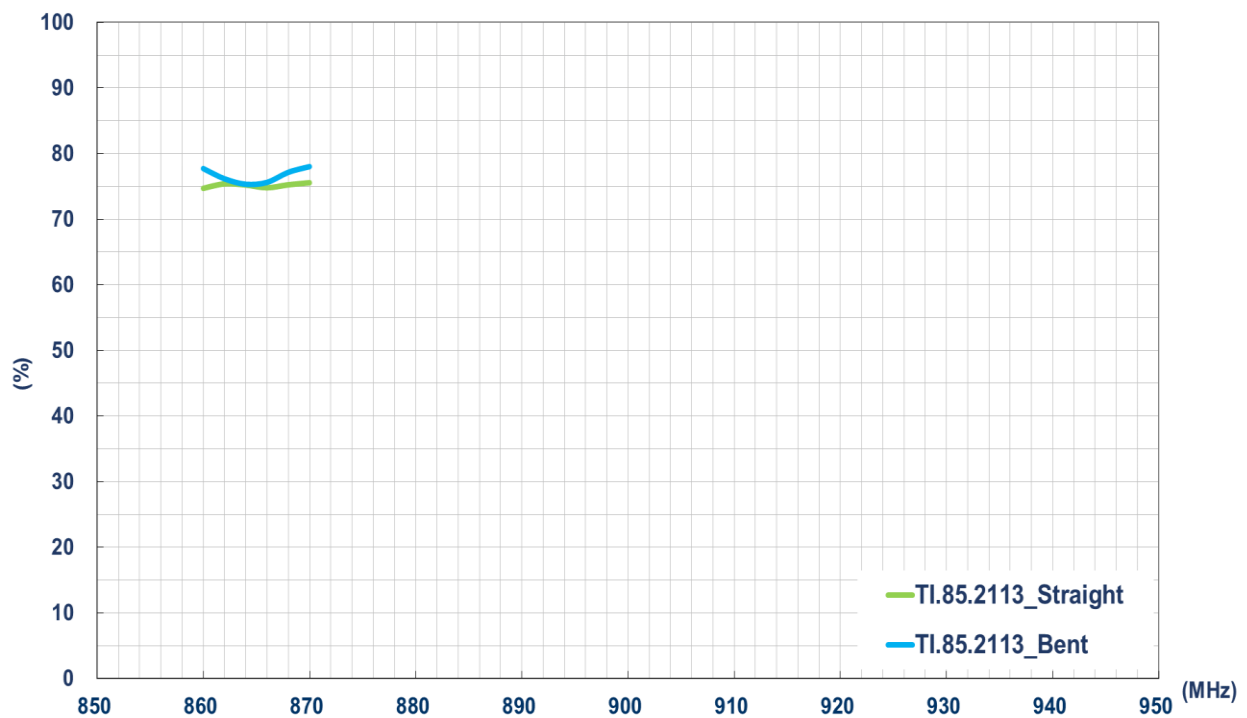

3.3 Average Gain

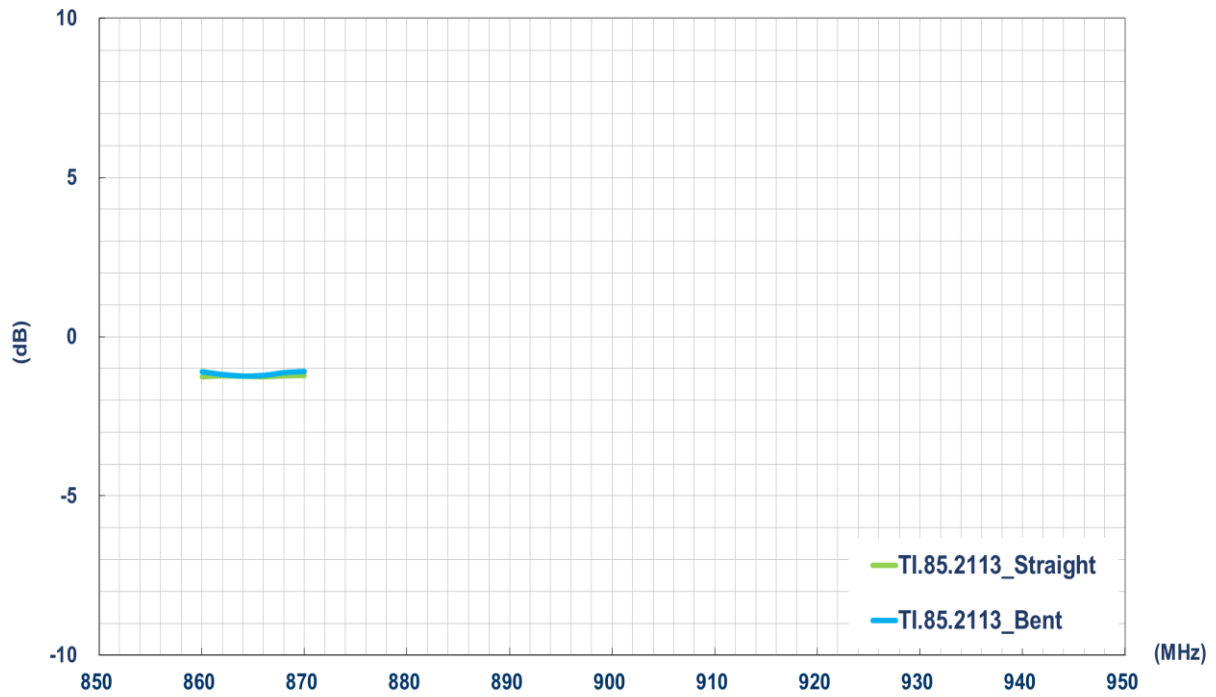

3.4 Peak Gain

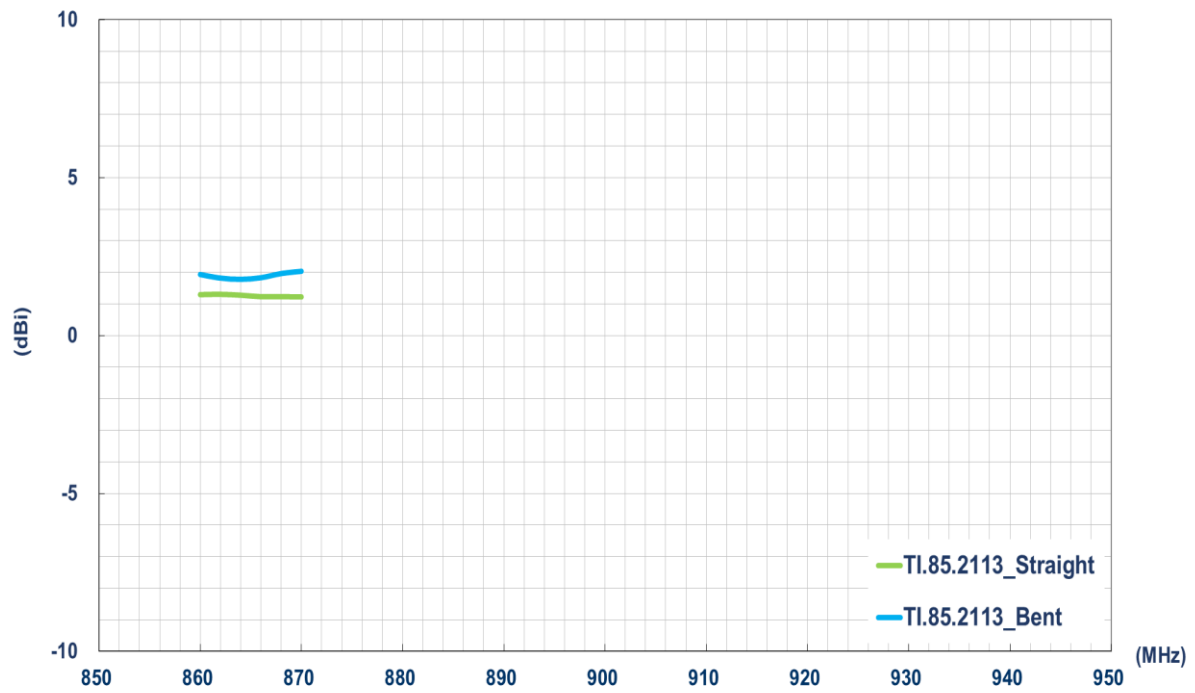

4. Radiation Patterns

4.1 Test Setup



Free space - Straight



Free space - Bent

4.2 868MHz 3D and 2D Radiation Patterns - Straight

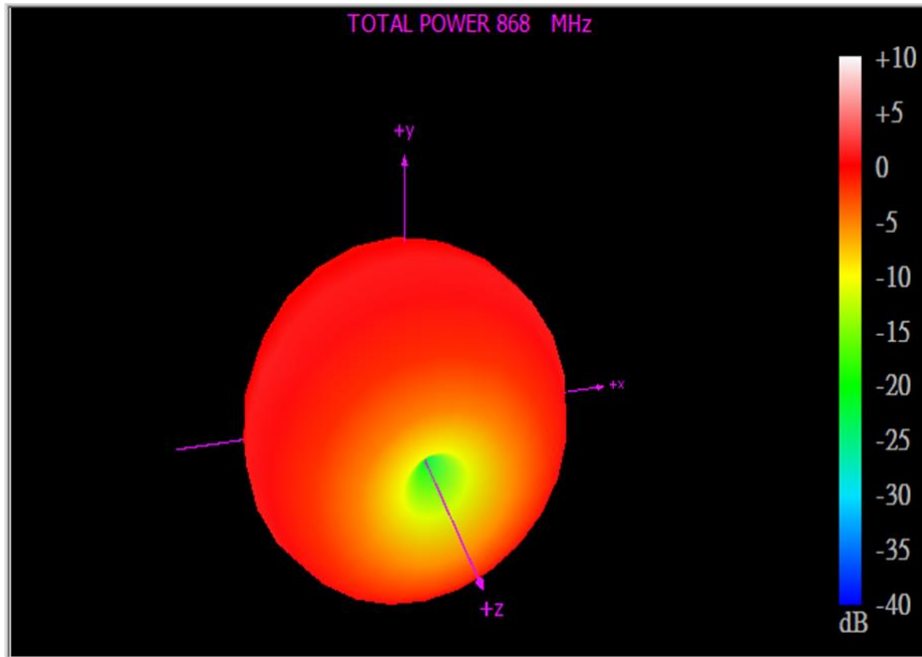

XY Plane XZ Plane YZ Plane

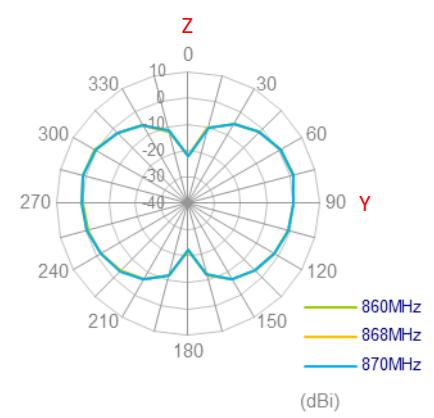
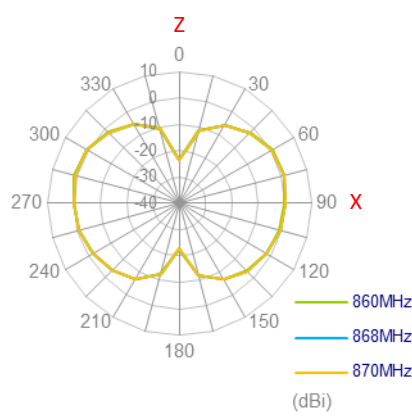
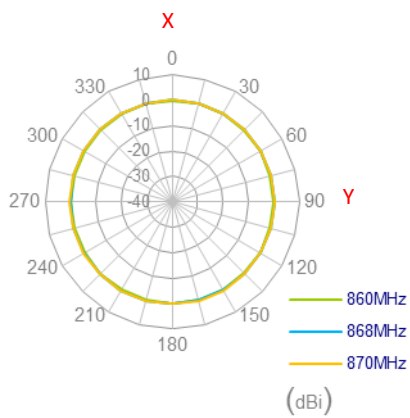

4.3 868MHz 3D and 2D Radiation Patterns - Bent

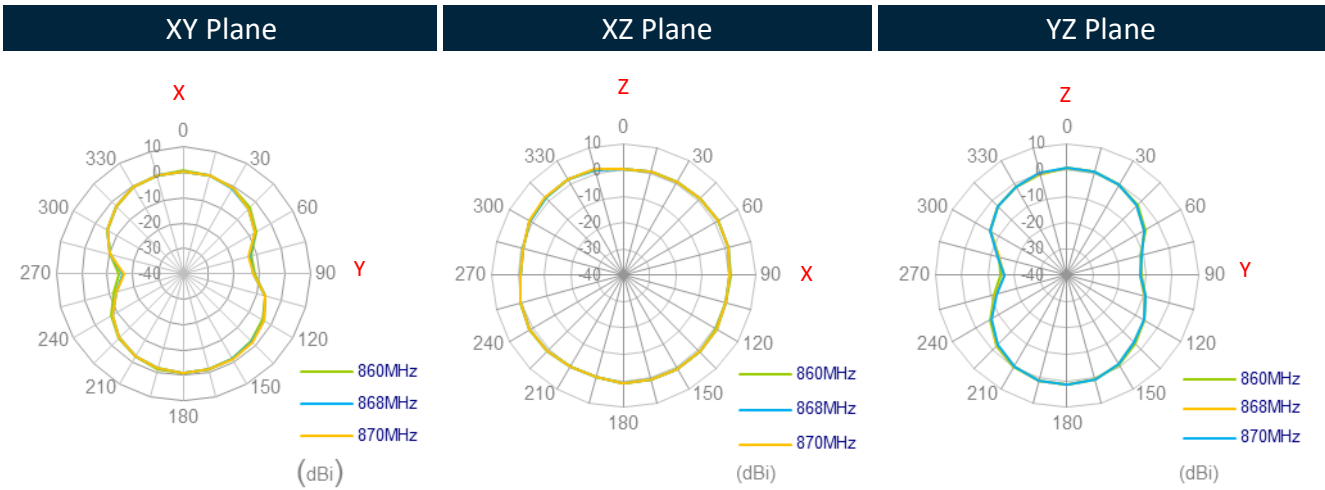
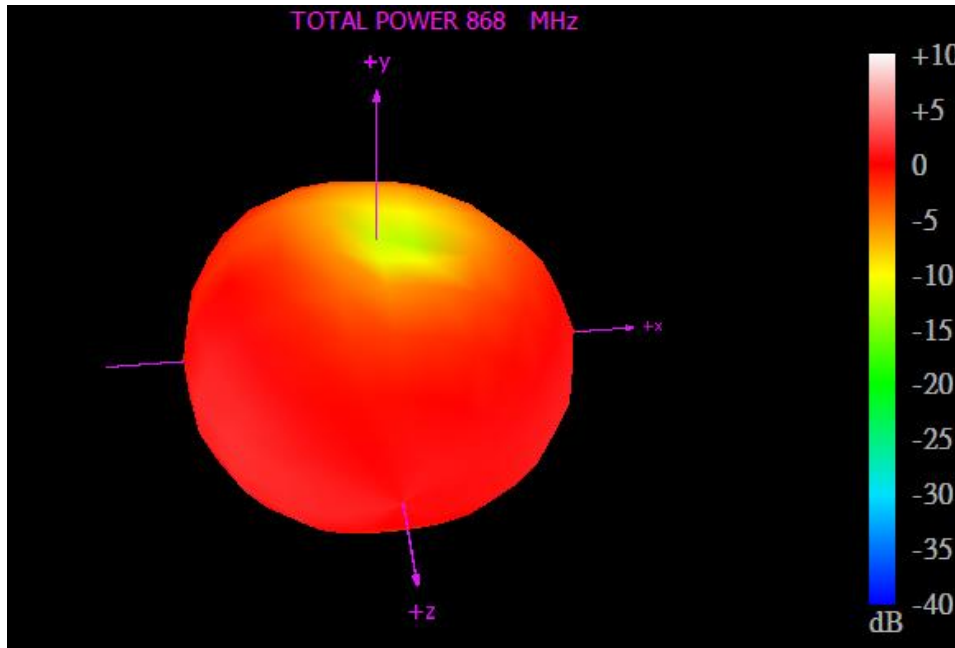

5. Mechanical Drawing (Units: mm)

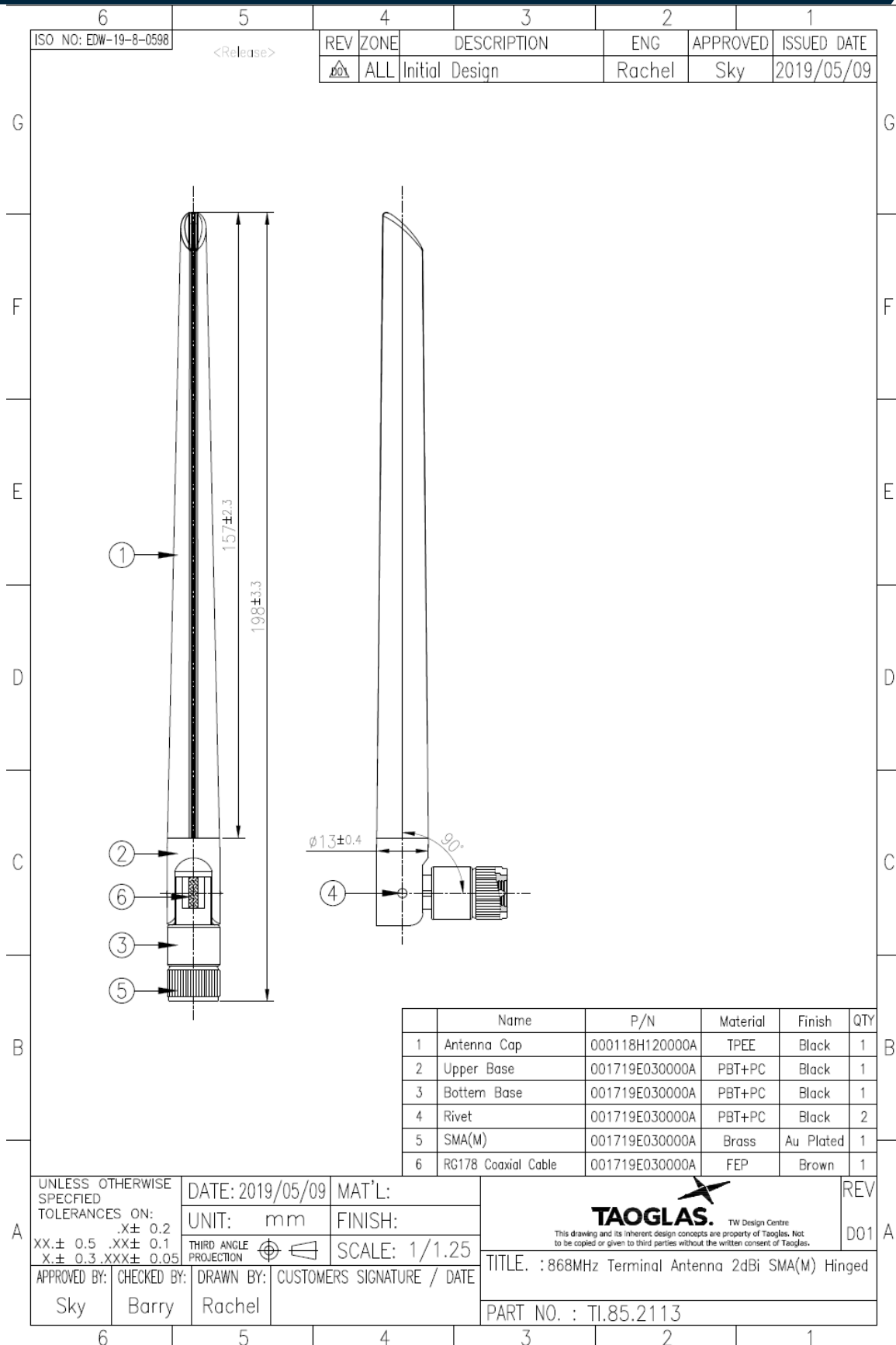

6. Packaging

1pc TI.85.2113 per PE Bag
 Tray Dimension: 245*30mm
 Weight: 22.5g

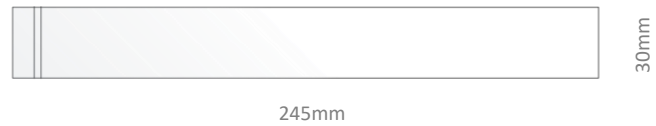

40pcs TI.85.2113 per Large PE Bag
 Bag Dimensions: 320*205mm
 Weight: 0.9Kg

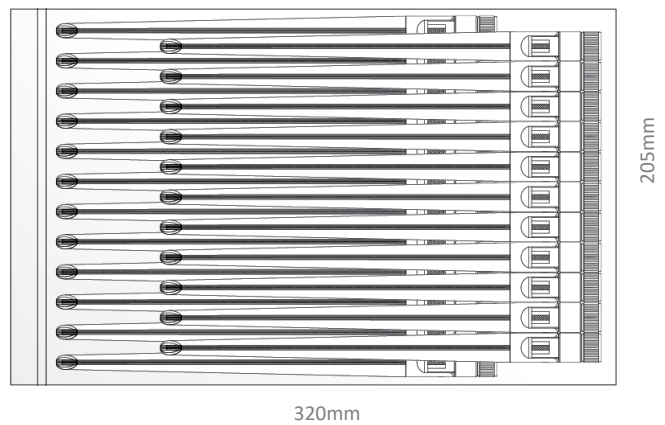

400pcs TI.85.2113 per Carton
 Dimensions: 320*250*230mm
 Weight: 10Kg

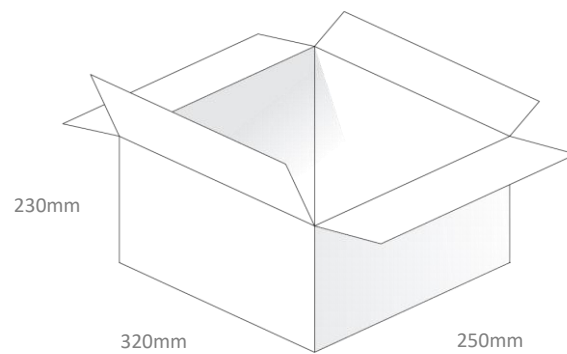

Pallet Dimensions:
 1200*1000*1350mm
 60 Cartons Per Pallet
 12 Cartons Per Layer, 5 Layers

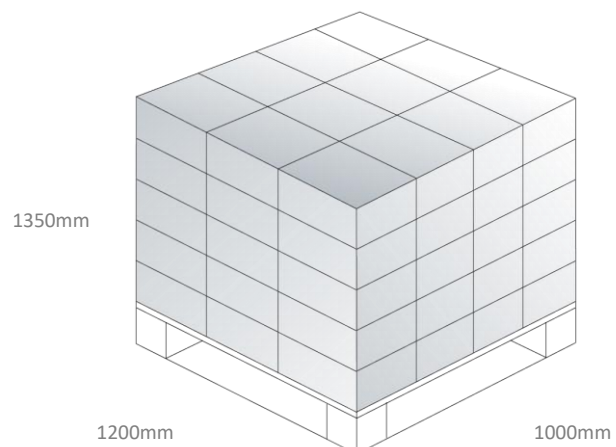

Changelog for the datasheet

SPE-19-8-075 – TI.85.2113

Revision: A (Original First Release)	
Date:	2019-06-12
Notes:	
Author:	Jack Conroy

Previous Revisions
