

**C TJ-108XL**

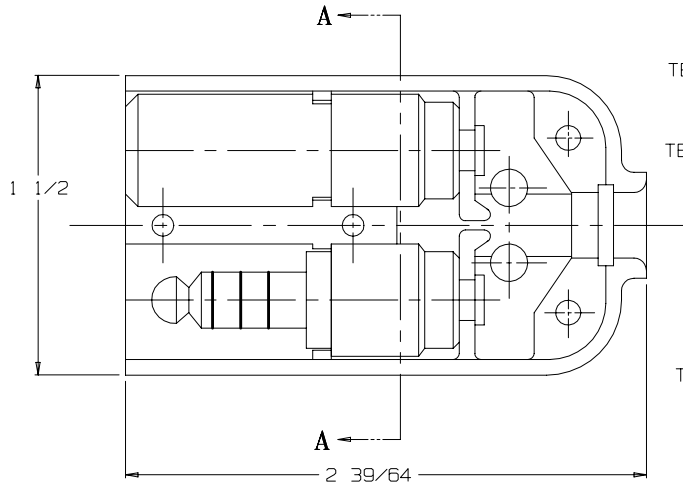

VIEW WITH HALF SHELL REMOVED

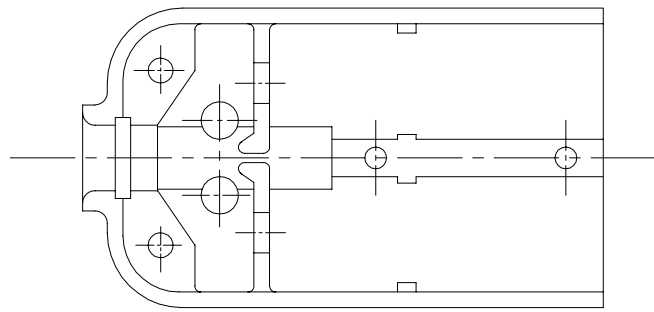

SHELL, HALF TJ-106-11

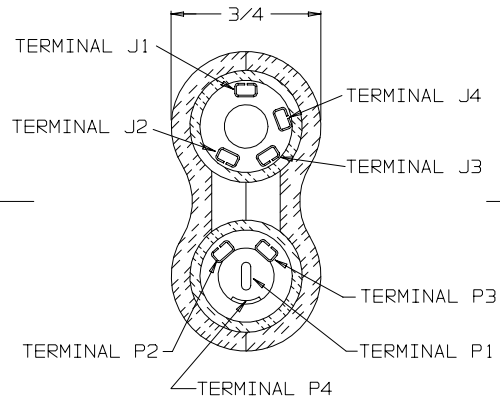

SECTION A-A

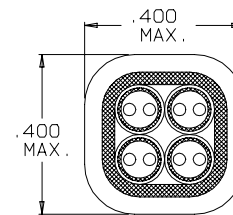
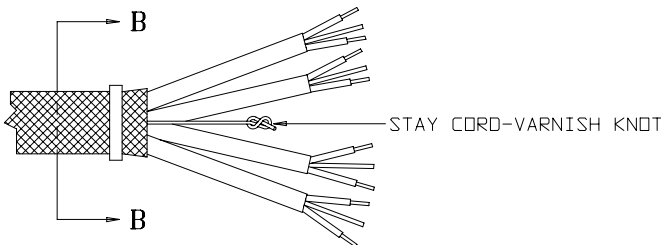
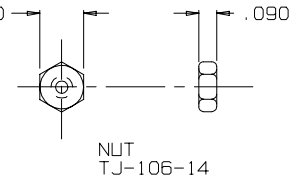
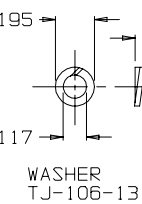
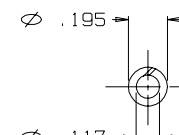
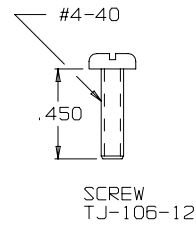
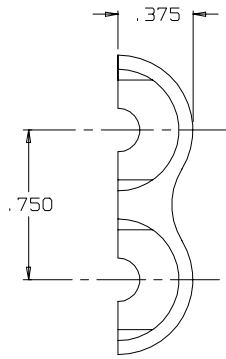
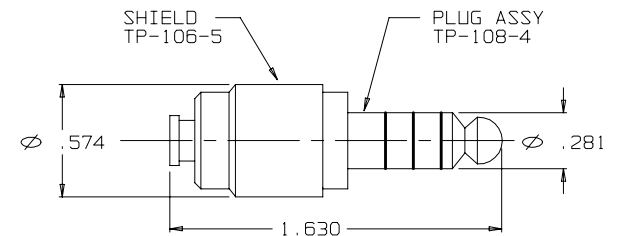
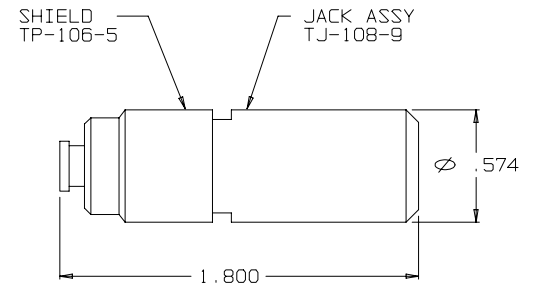
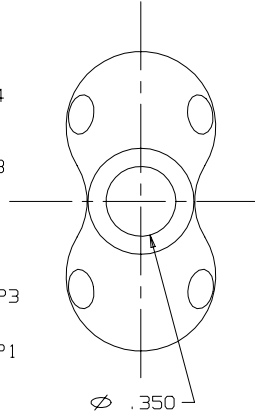

SECTION B-B  
STRAIN RELIEF CLAMP TJSS-106-6 AFTER CRIMPING SCALE 4:1

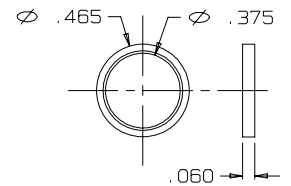

RING, STRAIN RELIEF TJSS-106-6

THIS DOCUMENT CONTAINS PROPRIETARY INFORMATION OF NEXUS, INCORPORATED AND SUCH INFORMATION MAY NOT BE DISCLOSED TO OTHERS FOR ANY PURPOSE OR USED FOR ANY PURPOSE WITHOUT THE WRITTEN CONSENT OF NEXUS.

DWN. BY <i>M. N. F.</i>	DATE 11/17/94	MATERIAL	
CHECKED BY	DATE	FINISH	
APPR. BY	DATE	WEIGHT	SCALE 2:1
UNLESS OTHERWISE SPECIFIED DIMENSIONS ARE IN INCHES TOLERANCES ON FRACTIONS DECIMALS ANGLES		TITLE	
±1/64	±.005	JACK-TELEPHONE-BIAXIAL SHIELDED (8) CONDUCTOR	
LET.	REVISION	DD NOT SCALE DWG.	SHEET 1 OF 1
CN #	DATE	NEXUS STAMFORD, CONN	
CHK.		SIZE DWG. NO.	
		C TJ-108XL	