

C TJS-108HC

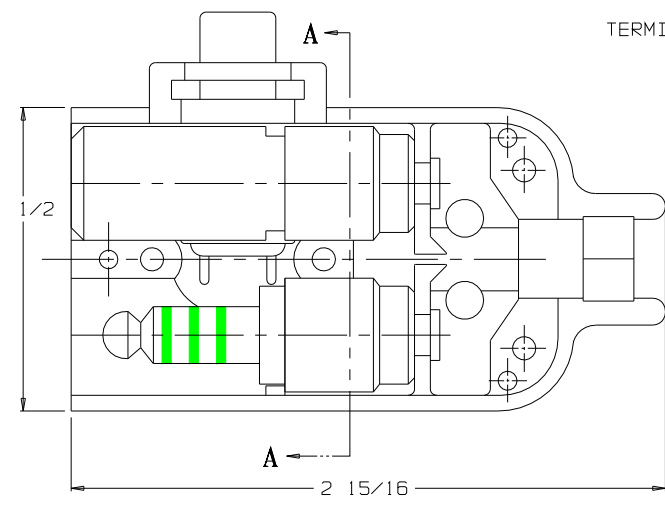

VIEW WITH HALF SHELL REMOVED

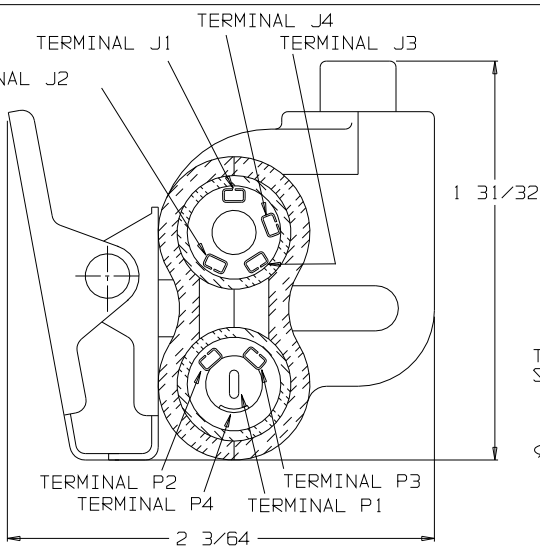

SECTION A-A

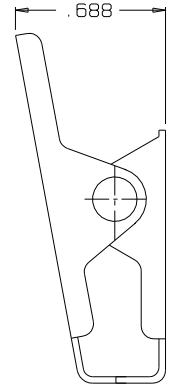
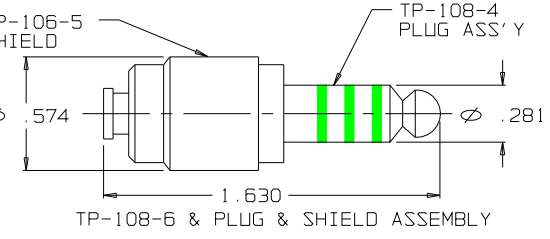
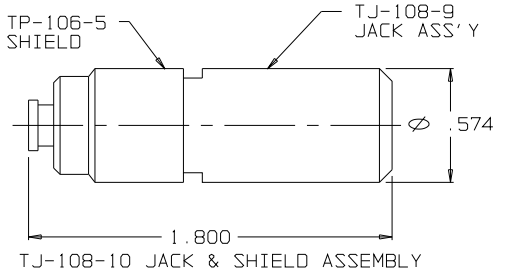

CLIP ASSY TJS-104-3A

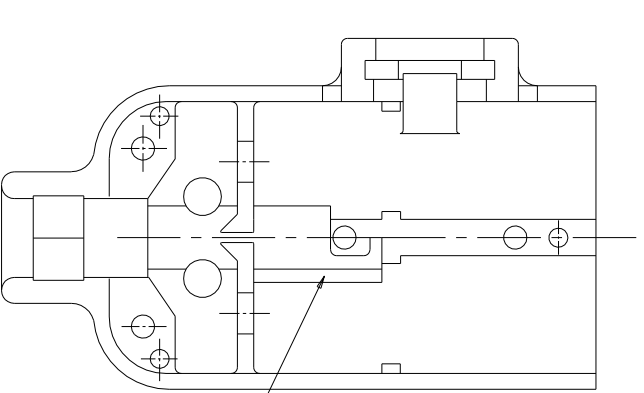

CHANNEL FOR SWITCH LEADS

SHELL, HALF TJS-106-1HC

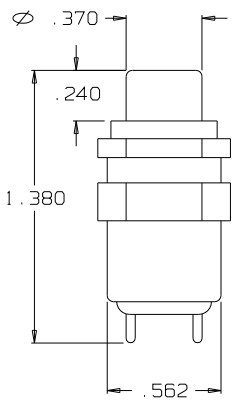
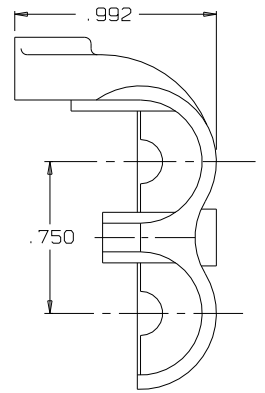

SWITCH NX301LB1B

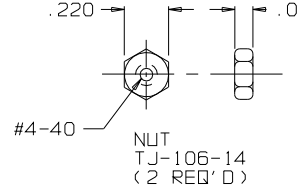

NUT TJ-106-14 (2 REQ'D)

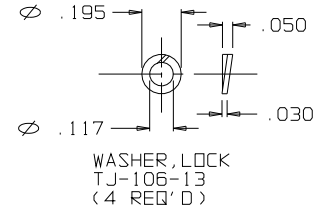

WASHER, LOCK TJ-106-13 (4 REQ'D)

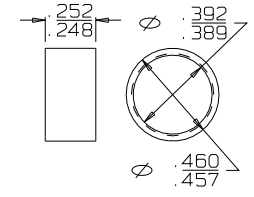

RING, STRAIN RELIEF TJSS-106-12

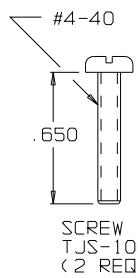

SCREW TJS-106-19 (2 REQ'D)

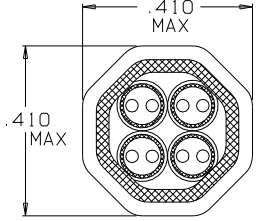

SECTION B-B

STRAIN RELIEF CLAMP TJSS-106-12 AFTER CRIMPING USE DANIELS HX4 CRIMP TOOL AND Y146 DIE SET SCALE 4:1

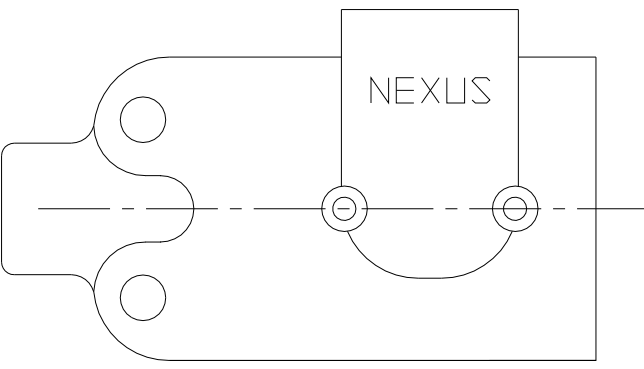

SHELL, HALF TJS-108-2HC

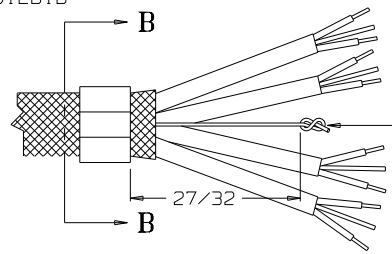

STAY CORD-VARNISH KNOT

THIS DOCUMENT CONTAINS PROPRIETARY INFORMATION OF NEXUS, INCORPORATED AND SUCH INFORMATION MAY NOT BE DISCLOSED TO OTHERS FOR ANY PURPOSE OR USED FOR ANY PURPOSE WITHOUT THE WRITTEN CONSENT OF NEXUS.

DWN. BY: EWT		DATE: 3/15/02		MATERIAL: _____	
CHECKED BY:		DATE:		FINISH: _____	
APPR. BY:		DATE:		WEIGHT: _____ SCALE: 2:1	
TITLE: JACK-TELEPHONE-BIAXIAL SHIELDED (8) CONDUCTOR WITH SWITCH / HEX CRIMP		DATE: 9/16/09		GPH	
DATE: 8/19/02		EWT		UNLESS OTHERWISE SPECIFIED DIMENSIONS ARE IN INCHES TOLERANCES ON FRACTIONS DECIMALS ANGLES	
LET. REVISION		CN #		DATE	
CHK		DATE		CHK	
DO NOT SCALE DWG.		SHEET 1 OF 1		NEXUS STAMFORD, CONN	
SIZE		DWG. NO.		C TJS-108HC	