

Features & Benefits

- Integrated current rail with 220 $\mu\Omega$ insertion resistance enables ultra-low power loss
- Less than 1nH parasitic inductance
- Smallest form factor, 8x8mm, Lead Tip Inspection
- High accurate, scalable, DC & AC current sensing
- 210kHz bandwidth for wide range of applications
- Very low sensitivity error over temperature
- Galvanic functional isolation up to 1150V peak V_{IORM}
- Documentation according ISO26262 available

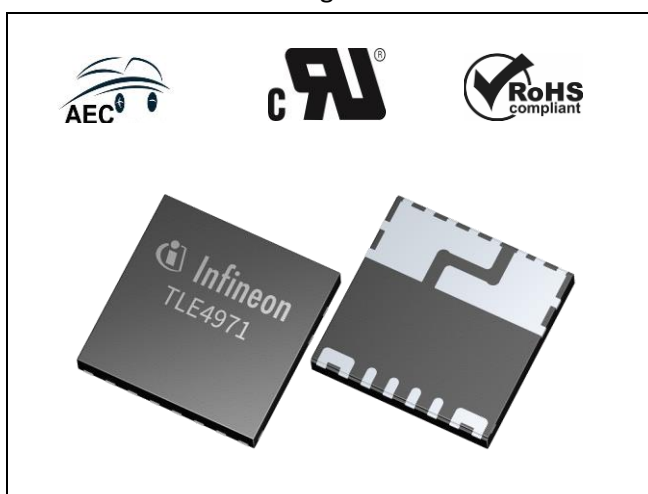

Coreless current sensor in PG-TISON-8-6 package

Description

TLE4971 is a high precision miniature coreless magnetic current sensor for AC and DC measurements with analog interface and two fast over-current detection outputs.

Infineon's well-established and robust monolithic Hall technology enables accurate and highly linear measurement of currents with a full scale up to $\pm 120A$. The sensor is equipped with internal self-diagnostic feature.

Typical applications are Onboard Chargers as well as any kind of Drives.

The differential measurement principle allows great stray field suppression for operation in harsh environments.

The sensor is shipped as a fully calibrated product without requiring any customer end-of-line calibration.

All user-programmable parameters such as OCD thresholds, blanking times and output configuration modes are stored in an embedded EEPROM memory.

Equipped with LTI-feature (Lead Tip Inspection) for easy end of line solder quality check.

Order Information

Product Name	Product Type	Marking	Ordering Code	Package
TLE4971-A120T5-E0001	120A range, QM+	H71E1A1_H	SP005737216	PG-TISON-8-6
TLE4971-A075T5-E0001	75A range, QM+	H71E3A1_H	SP005737212	PG-TISON-8-6
TLE4971-A050T5-E0001	50A range, QM+	H71E4A1_H	SP005737210	PG-TISON-8-6
TLE4971-A025T5-E0001	25A range, QM+	H71E6A1_H	SP005737208	PG-TISON-8-6
TLE4971-A120T5-U-E0001	120A range, UL-certified, QM+	H71E1A1UH	SP005737235	PG-TISON-8-6
TLE4971-A075T5-U-E0001	75A range, UL-certified, QM+	H71E3A1UH	SP005737228	PG-TISON-8-6
TLE4971-A050T5-U-E0001	50A range, UL-certified, QM+	H71E4A1UH	SP005737224	PG-TISON-8-6
TLE4971-A025T5-U-E0001	25A range, UL-certified, QM+	H71E6A1UH	SP005737220	PG-TISON-8-6

Pin Configuration

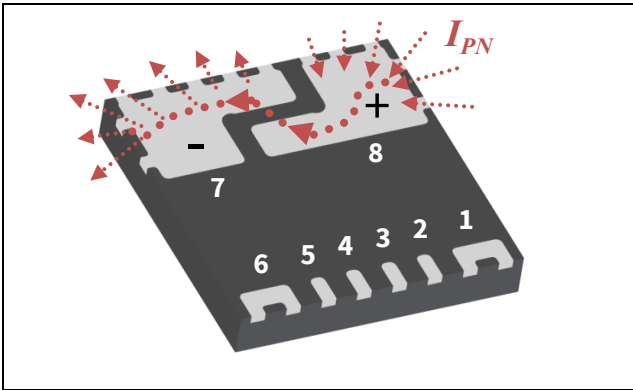

Figure 1 Pin layout PG-TISON-8-6

The current I_{PN} is measured as a positive value when it flows from pin 8 (+) to pin 7 (-) through the integrated current rail.

Pin configuration

Pin No.	Symbol	Function
1	VDD	Supply voltage
2	GND	Ground
3	VREF	Reference voltage input or output
4	AOUT	Analog signal output
5	OCD1	Over-current detection output 1 (open drain output)
6	OCD2	Over-current detection output 2 (open drain output)
7	IP-	Negative current terminal pin (current-out)
8	IP+	Positive current terminal pin (current-in)

Target Applications

The TLE4971 is suitable for AC as well as DC current measurement applications:

- On-Board Charger (OBC)
- Drives / Servo / Motor Control / Inverter / eScooter / eBike / LEV / EESM (externally excited synchronous machine)
- Current monitoring
- Overload and over-current detection

Due to its implemented magnetic interference suppression, it is extremely robust when exposed to external magnetic fields. The device is suitable for fast over-current detection with a configurable threshold level. This allows the control unit to switch off and protect the affected system from damage, independently from the main measurement path.

Standard Product Configuration

Table 1 Standard Product Configuration

Parameter	TLE4971-A120xxx	TLE4971-A075xxx	TLE4971-A050xxx	TLE4971-A025xxx
Full scale range ¹⁾	±120A	±75A	±50A	±25A
Output mode	Semi-differential	Semi-differential	Semi-differential	Semi-differential
Quiescent voltage	1.65V	1.65V	1.65V	1.65V
OCD1 threshold factor ²⁾	1.25	1.25	1.25	1.25
OCD1 threshold factor ²⁾	0.82	0.82	0.82	0.82
OCD filter time both channels ²⁾	0μs	0μs	0μs	0μs
Ratiometric mode	No	No	No	No

1) Optional sensitivity values are mentioned in Table 5.

2) Optional OCDx configuration are listed in Table 7 and Table 8.

Block Diagram

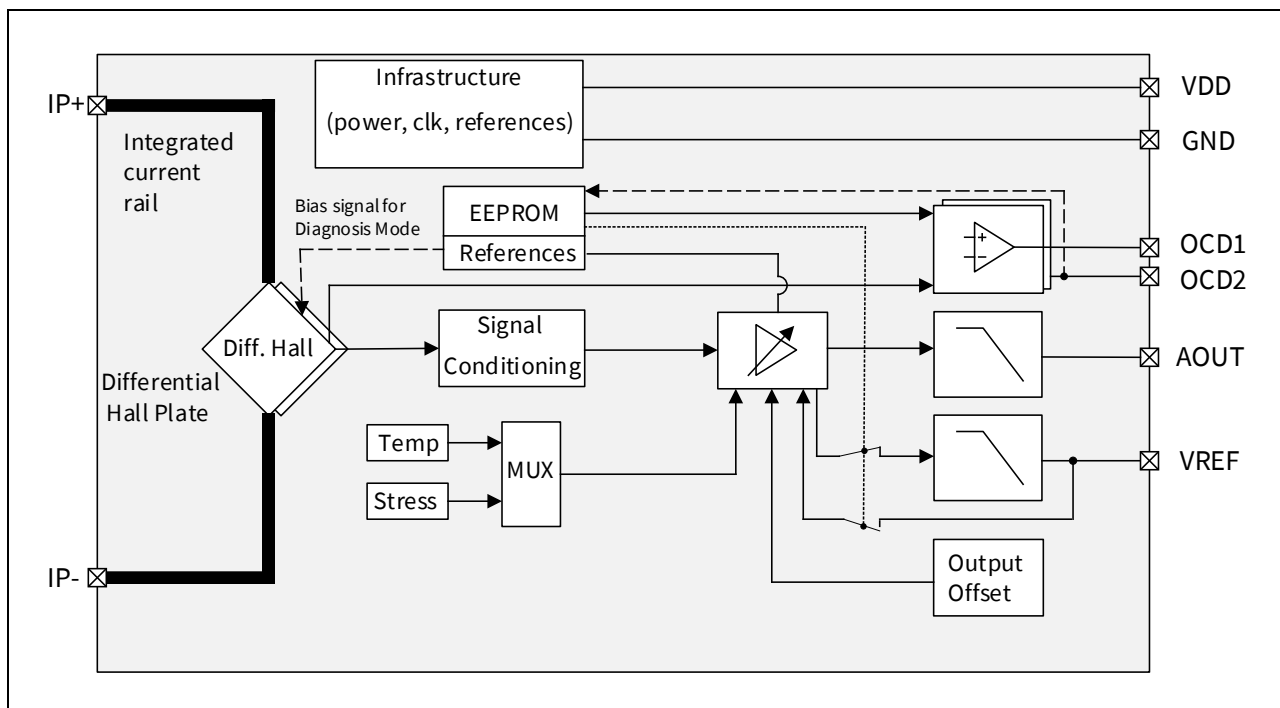

Figure 2 Block Diagram

General Description

TLE4971 is a high speed precision current sensor. Due to implemented EEPROM various configuration can be applied without using any external components.

Depending on the selected programming option, the analog output signal can be provided either as:

- Single-ended
- Fully-differential
- Semi-differential

In **single-ended** mode, the pin VREF is used as a reference voltage input. The analog output signal is provided on pin AOUT.

In **fully-differential** mode, both AOUT (positive polarity) and VREF (negative polarity) are used as signal outputs whereas VDD is used as reference voltage input.

In **semi-differential** mode a chip-internal reference voltage is used and provided on VREF (output).

For fast over-current detection, the raw analog signal provided by the Hall probes is fed into comparators with programmable switching thresholds.

A user-programmable deglitch filter is implemented to enable the suppression of fast switching transients. The open-drain outputs of the OCD pins are active “low” and they can be directly combined into a wired-AND configuration on board level to have a general over-current detection signal.

Programming of the memory can be performed in circuit through a Serial Inspection and Configuration Interface (SICI). The interface is described in detail in the programming guide which can be found on the Infineon website.

Absolute Maximum Ratings

Table 2 Absolute Maximum Ratings

General conditions (unless otherwise specified): $V_{DD} = 3.3V$; $T_S = -40^{\circ}C \dots +125^{\circ}C$

Parameter	Symbol	Min	Typ	Max	Unit	Note / Test Condition
Supply voltage	V_{DD}	-0.3	3.3	3.6	V	
		-	-	6.5	V	duration < 1 minute
Primary nominal rated current LF ¹⁾	I_{PNRLF}	-70	-	70	A	Peak, frequency < 10Hz. Tested on Infineon reference PCB (see related application note: AppNote TLx4971 PCB)
Primary nominal rated current HF ²⁾	I_{PNRHF}	-70	-	70	A	RMS, frequency $\geq 10Hz$. Tested on Infineon reference PCB (see related application note: AppNote TLx4971 PCB)
Primary current	I_{PNS}	-250	-	250	A	Single peak for 10 μs , 10 assertions per lifetime
Primary Surge current ³⁾	I_{PNS}	-2	-	2	kA	
Voltage on interface pins VREF, OCD1, AOUT	V_{IO}	-0.3	-	$V_{DD} + 0.3$	V	
Voltage on Interface pin OCD2	V_{IO_OCD2}	-0.3	-	21	V	
ESD voltage ⁴⁾	V_{ESD_HBM}	-2	-	2	kV	
ESD voltage ⁵⁾	V_{ESD_SYS}	-16	-	16	kV	In the application circuit
Voltage slew-rate on current rail	$\Delta V/dt$	-	-	10	V/ns	
				80	V/ns	Up to 300V working voltage / Reduced OCD-accuracy
Maximum junction temperature	T_{j_max}	-	-	130	$^{\circ}C$	
Storage temperature	T_{A_STORE}	-40	-	150	$^{\circ}C$	
Life time	LT	15	-	-	Years	Considering continuous operation with $T_S = 70^{\circ}C$ and $I = 30 A RMS$

1) Tested with primary nominal rated current of 70A peak on Infineon reference PCB at Low Frequency (LF). Thermal equilibrium reached after 2 min.

2) Tested with primary nominal rated current of 70A rms on Infineon reference PCB at High Frequency (HF). Thermal equilibrium reached after 2 min.

3) According to standard IEC 61000-4-5 electrical surge test class 4: 4kV at 2 Ω generator impedance

4) Human Body Model (HBM), according to standard AEC-Q 100-002

5) According to standard IEC 61000-4-2 electrostatic discharge immunity test

Stress above the limit values listed here may cause permanent damage to the device. Exposure to absolute maximum rating conditions for extended periods may affect device reliability. Maximum ratings are absolute ratings. Exceeding only one of these values may cause irreversible damage to the integrated circuit.

Product Characteristics

Table 3 Operating Ranges

General conditions (unless otherwise specified): $V_{DD} = 3.3V$; $T_S = -40^{\circ}C \dots +125^{\circ}C$

Parameter	Symbol	Min.	Typ.	Max.	Unit	Note / Test Condition
Supply voltage	V_{DD}	3.1	3.3	3.5	V	
Ambient temperature at soldering point ¹⁾	T_S	-40	-	125	$^{\circ}C$	Measured at soldering point, limited life time of 8800h
Ambient temperature at soldering point ¹⁾	T_S	-40	-	105	$^{\circ}C$	Measured at soldering point, Considering 8 years operation at $I = 32 A$ RMS
Capacitance on analog output pin	C_{AOUT}	4.7	6.8	8	nF	W/o decoupling resistor, including parasitic cap on the board
Capacitor on VDD	C_{VDD}	-	220	-	nF	
Reference input voltage	V_{REF}	-	1.65	-	V	Other values available by EEPROM: 1.2V, 1.5V, 1.8V
Reference input voltage variation	V_{REF_var}	-10	-	10	%	

1) Please find the link between T_A and T_S in Figure 17.

Table 4 Operating Parameters

General conditions (unless otherwise specified): $V_{DD} = 3.3V$; $T_S = -40^{\circ}C \dots +125^{\circ}C$

Parameter	Symbol	Min.	Typ.	Max.	Unit	Note / Test Condition
Current consumption	I_{DD}	-	18	25	mA	$I(AOUT) = 0mA$
Primary path resistance	R_{PN}	-	220	-	$\mu\Omega$	25 $^{\circ}C$, when soldered on PCB with 140 μm copper thickness
Power-on delay time	t_{POR}	-	1.0	1.5	ms	From V_{DD} rising above $V_{DD(min)}$ to full operation. Output with lower accuracy is available within 0.5 ms.
Voltage on interface pin OCD1	V_{IO_OCD1}	-0.3	-	3.5	V	
Voltage on interface pin OCD2	V_{IO_OCD2}	-0.3	-	3.5	V	In functional mode
Voltage on analog output AOUT	V_{AOUT}	-0.3	-	$V_{DD} + 0.3$	V	
Thermal resistance ¹⁾	R_{THJS}	-	0.25	-	K/W	Current rail to soldering point, on Infineon reference PCB (see related application note AppNote TLx4971 PCB)

1) Not subject to production test. Verified by design and characterization.

Functional Output Description

The analog output signal depends on the selected output mode:

- Single-ended
- Fully-differential
- Semi-differential

Single-Ended Output Mode

In single-ended mode VREF is used as an input pin to provide the analog reference voltage, V_{REF} . The voltage on AOUT, V_{AOUT} , is proportional to the measured current I_{PN} at the current rail:

$$V_{AOUT}(I_{PN}) = V_{OQ} + S \cdot I_{PN}$$

The quiescent voltage V_{OQ} is the value of V_{AOUT} when $I_{PN}=0$. V_{OQ} tracks the voltage on VREF

$$V_{OQ}(V_{REF}) = V_{REF}$$

The reference voltage can be set to different values which allow either bidirectional or unidirectional current sensing. The possible values of V_{REFNOM} are indicated in Table 3.

The sensitivity is by default non ratiometric to V_{REF} . If ratiometricity is activated the sensitivity becomes as follows:

$$S(V_{REF}) = S(V_{REFNOM}) \cdot \frac{V_{REF}}{V_{REFNOM}}$$

Fully-Differential Output Mode

In fully-differential output mode, both VREF and AOUT are analog outputs to achieve double voltage swing: AOUT is the non-inverting output, while VREF is the inverting output:

$$\begin{aligned} V_{AOUT}(I_{PN}) &= V_{QAOUT} + S \cdot I_{PN} \\ V_{REF}(I_{PN}) &= V_{QREF} - S \cdot I_{PN} \end{aligned}$$

The quiescent voltage is derived from the supply pins VDD and GND and has the same value on both AOUT and VREF:

$$V_{QAOUT}(V_{DD}) = V_{QREF}(V_{DD}) = \frac{V_{DD}}{2}$$

The sensitivity in the fully-differential mode can be generally expressed as:

$$S(V_{DD})_{diff} = S(3.3V)_{diff} \cdot \frac{V_{DD}}{3.3V}$$

In this mode, the quiescent voltages and the sensitivity are both ratiometric with respect to V_{DD} if ratiometricity is enabled.

Semi-Differential Output Mode

In semi-differential output mode, the sensor is using a chip-internal reference voltage to generate the quiescent voltage that is available on pin VREF (used as output).

The analog measurement result is available as single-ended output signal on AOUT. The dependence of sensitivity and output offset on reference voltage is the same as described in single-ended output mode.

The quiescent voltage is programmable at 3 different values, V_{OQbid_1} and V_{OQbid_2} for bidirectional current and V_{OQuni} for unidirectional current (see Table 5).

Table 5 Analog Output Characteristics

General conditions (unless otherwise specified): $V_{DD} = 3.3V$; $T_S = -40^{\circ}C \dots +125^{\circ}C$

Parameter	Symbol	Min	Typ	Max	Unit	Note / Test conditions
Quiescent output voltage (bidirectional option 1) ¹⁾²⁾	V_{OQbid_1}	-	$V_{DD}/2$	-	V	$I_{PN} = 0A$; fully-differential or semi-differential (bidirectional) modes, standard setting
Quiescent output voltage (bidirectional option 2) ²⁾	V_{OQbid_2}	-	1.5	-	V	$I_{PN} = 0A$; semi-differential (bidirectional) mode; for this option the ratiometricity offset is disabled
Quiescent output voltage (unidirectional mode) ²⁾	V_{OQuni}	-	$V_{DD}/5.5$	-	V	$I_{PN} = 0A$; semi-differential (unidirectional) mode
Sensitivity, range1 ¹⁾²⁾³⁾	S1	-	10	-	mV/A	$\pm 120A$ FS (Full Scale)
Sensitivity, range2 ²⁾³⁾	S2	-	12	-	mV/A	$\pm 100A$ FS
Sensitivity, range3 ²⁾³⁾	S3	-	16	-	mV/A	$\pm 75A$ FS
Sensitivity, range4 ²⁾³⁾	S4	-	24	-	mV/A	$\pm 50A$ FS
Sensitivity, range5 ²⁾³⁾	S5	-	32	-	mV/A	$\pm 37.5A$ FS
Sensitivity, range6 ²⁾³⁾	S6	-	48	-	mV/A	$\pm 25A$ FS
Sensitivity ratiometricity factor	K_S	-	1	-	-	
Quiescent ratiometricity factor	K_{OQ}	-	1	-	-	
Analog output drive capability	I_O	-2	-	2	mA	DC current
Analog output saturation voltage	V_{SAT}	-	150	300	mV	Output current = 2mA
Transfer function cutoff frequency	BW	120	210	-	kHz	-3dB criterion, $C_0 = 6.8nF$
Output phase delay ⁴⁾	φ_{delay}	-	45	60	°	$f_{signal} = 120kHz$
Output noise density ⁵⁾⁶⁾	I_{NOISE}	-	260	660	$\mu A/\sqrt{Hz}$	Typical value is at 25°C.
External homogenous magnetic field suppression ⁴⁾	B_{SR}	34	50	-	dB	Frequency up to 150kHz. Up to 20mT homogeneous field applied

1) Pre-configured setting, for other pre-configured versions please contact your local sales.

2) Can be programmed by user (valid only for 120A version).

3) Values refer to semi-differential mode or single-ended mode, with $V_{REF} = 1.65V$.

In full-differential mode the sensitivity value is doubled.

4) Not subject to production test. Verified by design and characterization.

5) Typical value in full-differential mode, sensitivity range S6

$$6) \text{ Noise Density} = \frac{\text{Output Noise [V}_{RMS}]}{\sqrt{\frac{\pi}{2} * BW[Hz]}} * \frac{1}{\text{Sensitivity} \left[\frac{V}{A} \right]}$$

Table 5 Analog Output Characteristics (cont'd)

General conditions (unless otherwise specified): $V_{DD} = 3.3V$; $T_S = -40^{\circ}C \dots +125^{\circ}C$

Parameter	Symbol	Min	Typ	Max	Unit	Note / Test conditions
Sensitivity error (all ranges) ⁷⁾	E_{SENS}	-	± 1.5	-	%	$T_S = 25^{\circ}C, 0h$
Sensitivity error (all ranges) over temperature ⁷⁾	E_{SENS_T}	-	± 2.0	-	%	$T_S = -40^{\circ}C \text{ to } 25^{\circ}C, 0h$
		-	± 1.5	-	%	$T_S = 25^{\circ}C \text{ to } 125^{\circ}C, 0h$
Sensitivity error (all ranges) over temperature and lifetime ⁴⁾⁷⁾	E_{SENS_L}	-3	± 2.0	3	%	
Output offset (all ranges) ⁷⁾	E_{OFF}	-	± 180	-	mA	$T_S = 25^{\circ}C, 0h$
Output offset (all ranges) over temperature ⁷⁾	E_{OFF_T}	-	± 230	-	mA	$T_S = -40^{\circ}C \text{ to } 25^{\circ}C, 0h$
		-	± 230	-	mA	$T_S = 25^{\circ}C \text{ to } 125^{\circ}C, 0h$
Output offset (all ranges) over temperature and lifetime ⁴⁾⁷⁾	E_{OFF_L}	-500	± 230	500	mA	
Total error (S1) ⁷⁾	$E_{TOT_{S1}}$	-	± 1.7	-	%	$T_S = 25^{\circ}C, 0h$, includes linearity error
Total error (S1) over temperature ⁷⁾	$E_{TOT_{S1}}$	-	± 2.3	-	%	$T_S = -40^{\circ}C \text{ to } 25^{\circ}C, 0h$, includes linearity error
		-	± 1.7	-	%	$T_S = 25^{\circ}C \text{ to } 125^{\circ}C, 0h$, includes linearity error
Total error (S6) ⁷⁾	$E_{TOT_{S6}}$	-	± 1.5	-	%	$T_S = 25^{\circ}C, 0h$, includes linearity error
Total error (S6) over temperature ⁷⁾	$E_{TOT_{S6}}$	-	± 2.3	-	%	$T_S = -40^{\circ}C \text{ to } 25^{\circ}C, 0h$, includes linearity error
		-	± 1.8	-	%	$T_S = 25^{\circ}C \text{ to } 125^{\circ}C, 0h$, includes linearity error
Total error over temperature and lifetime ⁴⁾⁷⁾	E_{TOTL}	-3.45	± 2.3	3.45	%	Percentage of FS, sensitivity S1; includes sensitivity, offset and linearity error

4) Not subject to production test. Verified by design and characterization. Based on High-Temperature-Over-Lifetime investigation and readout after lifetime.

7) Min/Max values derived from AEC-Q100 qualification. Typical values are ± 3 sigma values measured during "High Temperature Over Lifetime"-Test.

Fast Over-Current Detection (OCD)

The Over-Current Detection (OCD) function allows fast detection of over-current events. The raw analog output of the Hall probes is fed directly into comparators with programmable switching thresholds. A user programmable deglitch filter is implemented to enable the suppression of fast switching transients. The two different open-drain OCD pins are active low and can be directly combined into a wired-AND configuration on board level to have a general over-current detection signal. TLE4971 supports two independent programmable OCD outputs, suited for different application needs.

The OCD pins are providing a very fast response, thanks to independence from the main signal path. They can be used as a trap functionality to quickly shut down the current source as well as for precise detection of soft overload conditions.

OCD pins external connection

The OCD pins are designed as open-drain outputs and can be connected to a logic input pin of the microcontroller and/or the pre-driver to quickly react to over-current events. The OCD1 pins can be easily setup in a wired-AND configuration to monitor several current sensors outputs via only one microcontroller pin. OCD2 pins from different sensors shall not be connected together, if diagnosis mode is enabled in the EEPROM (default). In this case, the OCD2 fault indication of one sensor might unintentionally activate the diagnosis mode on the other sensors by forcing the pin to ground. Details about the diagnosis mode are provided in the safety manual of the device.

OCD thresholds

The symmetric threshold level of the OCD outputs is adjustable and triggers an over-current event in case of a positive or negative over-current. The possible threshold levels are listed in Table 7 and Table 8. The instruction for the settings is documented in the TLE4971 programming guide and the TLE4971 addendum.

OCD outputs timing behavior

Both output pins feature a deglitch filter to avoid false triggers by noise spikes on the current rail. Deglitch filter settings can be programmed according to application needs. Available options are listed in Table 7 and Table 8.

Figure 3 shows the OCD output pin typical behavior during an over-current event.

Over-current Pulse 1: duration exceeds the over-current response time t_{D_OCDx} + response time jitter Δt_{D_OCDx} + deglitch filter time $t_{deglitch}$. The OCD output voltage is set low until the current value drops below the OCD threshold.

Over-current Pulse 2: duration does not exceed the over-current response time t_{D_OCDx} and therefore no OCD event is generated.

Over-current Pulse 3: duration exceeds the response time t_{D_OCDx} + response time jitter Δt_{D_OCDx} , but does not exceed the glitch filter time $t_{deglitch}$ and no OCD event is generated.

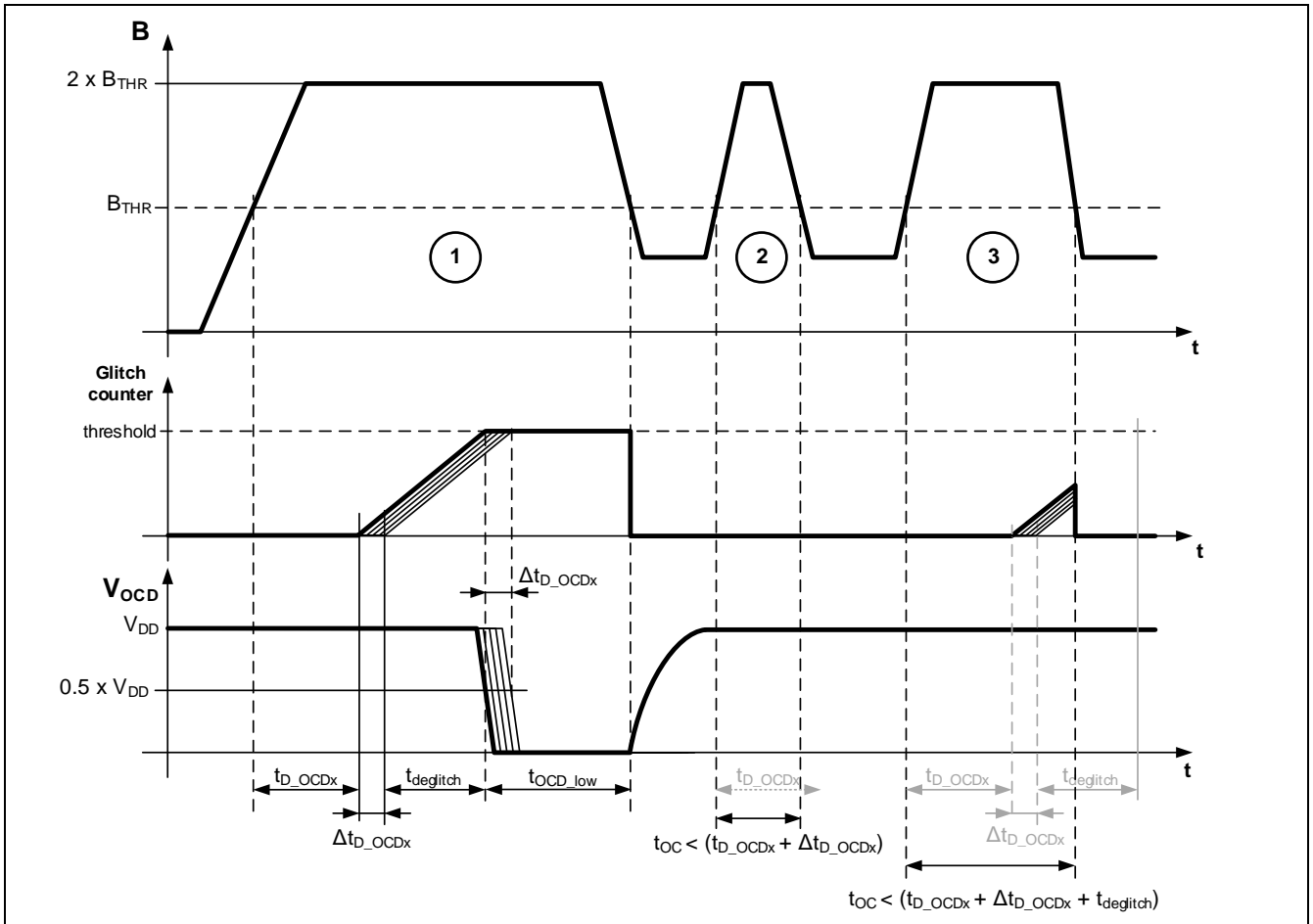

Figure 3 Fast over-current detection output timing

Fast Over-Current Detection (OCD) Output Parameters

Table 6 Common OCD Parameters

General conditions (unless otherwise specified): $V_{DD} = 3.3V$; $T_S = -40^{\circ}C \dots +125^{\circ}C$, $C_L = 1nF$.

Parameter	Symbol	Min	Typ	Max	Unit	Note / Test Conditions
Threshold level tolerance ¹⁾	I_{THT}	-10	-	10	%	Type tested
Response time jitter ¹⁾	Δt_{D_OCD}	-	-	0.25	μs	At 3σ , $I_{rail} = 2 \times I_{THR,x}$, input rise time $0.1\mu s$
Deglitch filter basic time	t_{OCDgl}	400	500	600	ns	
Detection minimum time	t_{OCD_low}	3	-	-	μs	Valid for both OCDs
Load capacitance	t_{OCD_low}	-	-	1	nF	
Open-drain current	C_L	-	-	1	mA	DC current
Pull-up resistor	R_{PU}	1	4.7	10	k Ω	To V_{DD}

1) Not subject to production test. Verified by design and characterization.

Table 7 OCD1 Parameters

Parameter	Symbol	Min	Typ	Max	Unit	Note / Test Conditions
Threshold level - Level1 ^{1)2) 3)}	$I_{THR1.1}$	-	1.25	-	x I _{FS}	Factor with respect to I _{FS} (I _{FS} = current full scale according to programming i.e. 120A)
Threshold level - Level2 ¹⁾²⁾	$I_{THR1.2}$	-	1.39	-	x I _{FS}	Factor with respect to I _{FS}
Threshold level - Level3 ¹⁾²⁾	$I_{THR1.3}$	-	1.54	-	x I _{FS}	Factor with respect to I _{FS}
Threshold level - Level4 ¹⁾²⁾	$I_{THR1.4}$	-	1.68	-	x I _{FS}	Factor with respect to I _{FS}
Threshold level - Level5 ¹⁾²⁾	$I_{THR1.5}$	-	1.82	-	x I _{FS}	Factor with respect to I _{FS}
Threshold level - Level6 ¹⁾²⁾	$I_{THR1.6}$	-	1.96	-	x I _{FS}	Factor with respect to I _{FS}
Threshold level - Level7 ¹⁾²⁾	$I_{THR1.7}$	-	2.11	-	x I _{FS}	Factor with respect to I _{FS}
Threshold level - Level8 ¹⁾²⁾	$I_{THR1.8}$	-	2.25	-	x I _{FS}	Factor with respect to I _{FS}
Response time ⁴⁾	t_{D_OCD1}	-	0.7	1	μs	I _{PN} = 2 * I _{THR1.x}
Fall time ⁵⁾	t_{f_OCD1}	-	100	150	ns	
Deglintch filter setting ²⁾⁶⁾	$OCD1_{gl_mul}$	0	-	7	-	$t_{deglitch} = OCD1_{gl_mul} * t_{OCDgl}$ pre-configured setting = 0

- 1) Symmetric threshold level for positive and negative currents.
- 2) Can be programmed by user.
- 3) Pre-configured threshold level
- 4) Time between primary current exceeding current threshold and falling edge of OCD1-pin at 50%.
- 5) Not subject to production test. Verified by design and characterization.
- 6) The specified deglitching timing is valid when input current step overtakes the threshold of at least 10%.

Table 8 OCD2 Parameters

Parameter	Symbol	Min	Typ	Max	Unit	Note / Test Conditions
Threshold level - level1 ¹⁾²⁾	$I_{THR2.1}$	-	0.5	-	x I _{FSR}	Factor with respect to I _{FS} (I _{FS} = current full scale according to programming i.e. 120A)
Threshold level - level2 ¹⁾²⁾	$I_{THR2.2}$	-	0.61	-	x I _{FSR}	Factor with respect to I _{FS}
Threshold level - level3 ¹⁾²⁾	$I_{THR2.3}$	-	0.71	-	x I _{FSR}	Factor with respect to I _{FS}
Threshold level - level4 ¹⁾²⁾³⁾	$I_{THR2.4}$	-	0.82	-	x I _{FSR}	Factor with respect to I _{FS}
Threshold level - level5 ¹⁾²⁾	$I_{THR2.5}$	-	0.93	-	x I _{FSR}	Factor with respect to I _{FS}
Threshold level - level6 ¹⁾²⁾	$I_{THR2.6}$	-	1.04	-	x I _{FSR}	Factor with respect to I _{FS}
Threshold level - level7 ¹⁾²⁾	$I_{THR2.7}$	-	1.14	-	x I _{FSR}	Factor with respect to I _{FS}
Threshold level - level8 ¹⁾²⁾	$I_{THR2.8}$	-	1.25	-	x I _{FSR}	Factor with respect to I _{FS}
Response time ⁴⁾	t_{D_OCD2}	-	700	1200	ns	I _{PN} = 2 x I _{THR2.x}
Fall time ⁵⁾	t_{f_OCD2}	-	200	300	ns	
Deglintch filter setting ²⁾⁶⁾	$OCD2_{gl_mul}$	0	-	15	-	$t_{deglitch} = OCD2_{gl_mul} * t_{OCDgl}$ pre-configured setting = 0

- 1) Symmetric threshold level for positive and negative currents.
- 2) Can be programmed by user.
- 3) Pre-configured threshold level.
- 4) Time between primary current exceeding current threshold and falling edge of OCD2-pin at 50%.
- 5) Not subject to production test. Verified by design and characterization.
- 6) The specified deglitching timing is valid when input current step overtakes the threshold of at least 10%.

Undervoltage / Overvoltage detection

TLE4971 is able to detect undervoltage or overvoltage condition of its own power supply (V_{DD}). When an undervoltage ($V_{DD} < U_{VLOH}$) or overvoltage ($V_{DD} > O_{VLOH}$) condition is detected both OCD pins are pulled down in order to signal such a condition to the user.

The undervoltage detection on OCD pins is performed only if $V_{DD} > V_{DD, OCD}$.

Both OCD pins are pulled down at start up. When V_{DD} exceeds the undervoltage threshold U_{VLOH_R} and the power on delay time t_{POR} has been reached, the sensor indicates the correct functionality and high accuracy by releasing the OCD pins.

Please note the package variant TISON-8-6 comes with additional safety-features switched on by default. For more details please check the safety manual or contact your local sales engineer.

Table 9 Operating Parameters

General conditions (unless otherwise specified): $V_{DD} = 3.3V$; $T_S = -40^{\circ}C \dots +125^{\circ}C$

Parameter	Symbol	Min.	Typ.	Max.	Unit	Note / Test Condition
Supply undervoltage lockout threshold	U_{VLOH_R}	-	-	2.9	V	V_{DD} at rising edge
Supply undervoltage lockout threshold	U_{VLOH_F}	2.5	-	-	V	V_{DD} at falling edge
Supply overvoltage lockout threshold	O_{VLOH}	3.55	-	-	V	V_{DD} at rising edge
OCD undervoltage detection limit	$V_{DD, OCD}$	1.8	-	-	V	For $V_{DD} < V_{DD, OCD}$ undervoltage may not be performed.
Undervoltage/overvoltage lockout delay	t_{UVLOe}	1	2.4	3.1	μs	Enabled to disabled

1) Not subject to production test. Verified by design and characterization.

Isolation Characteristics

TLE4971 conforms functional isolation.

Table 10 Isolation Characteristics

Parameter	Symbol	Min	Typ	Max	Unit	Note / Test Conditions
Maximum rated working voltage (sine wave) ¹⁾²⁾³⁾	V_{IOWM}	-	-	690	V	RMS, @ 4000m altitude
Maximum rated working voltage (sine wave) ¹⁾²⁾³⁾	V_{IOWMP}	-	-	975	V	Peak, @ 4000m altitude
Maximum repetitive isolation voltage ²⁾³⁾	V_{IORM}	-	-	1150	V	Max DC voltage, spike, @ 4000m altitude
Apparent charge voltage capability (method B) ²⁾³⁾	V_{PDtest}	1500	-	-	V	Partial discharge < 5pC peak @ 0m altitude
Isolation test voltage ³⁾⁴⁾	V_{ISO}	3500	-	-	V	RMS, 60s
Isolation production test voltage ⁴⁾	V_{ISOP}	3000	-	-	V	RMS, in production, 1.2s, UL certified version
Isolation pulse test voltage ³⁾	V_{pulse}	6500	-	-	V	Peak, rise time = 1.2 μ s, fall time = 50 μ s
Minimum external creepage distance	CPG	4	-	-	mm	
Minimum external clearance distance	CLR	4	-	-	mm	
Minimum comparative tracking index	CTI	Material group II	-	-	-	
Isolation resistance ³⁾	R_{IO}	10	-	-	G Ω	$U_{IO} = 500V$ DC, 1min

1) The given value is considered an example based on pollution degree 2.

2) After stress test according to qualification plan.

3) Not subject to production test. Verified by design and characterization.

4) Agency type tested for 60 seconds by UL according to UL 1577 standard.

TLE4971 characteristics are tested at VDE according to basic isolation (standard IEC 62368-1:2018) as well and a report is available on request.

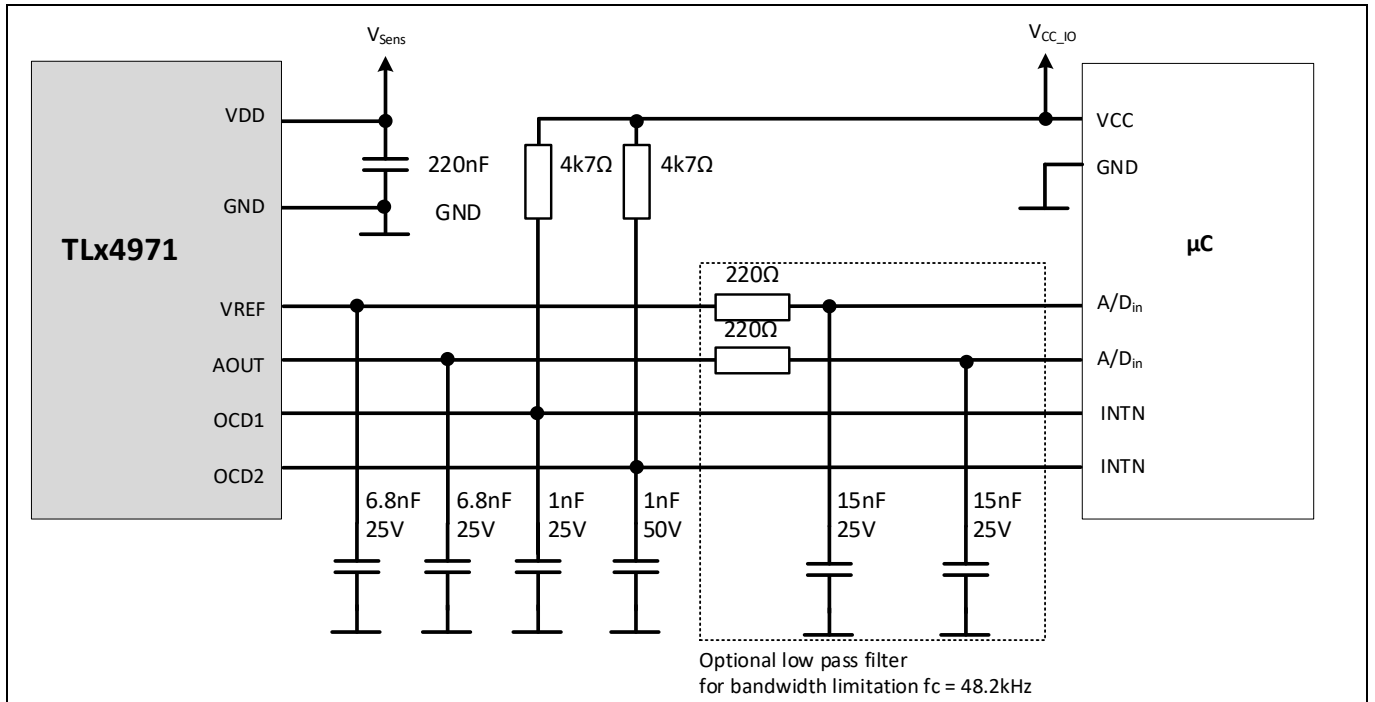

Figure 6 Application circuit with external components. In-circuit-programming not included.

For bandwidth limitation an external filter is recommended as shown in the above application circuits.

Typical Performance Characteristics

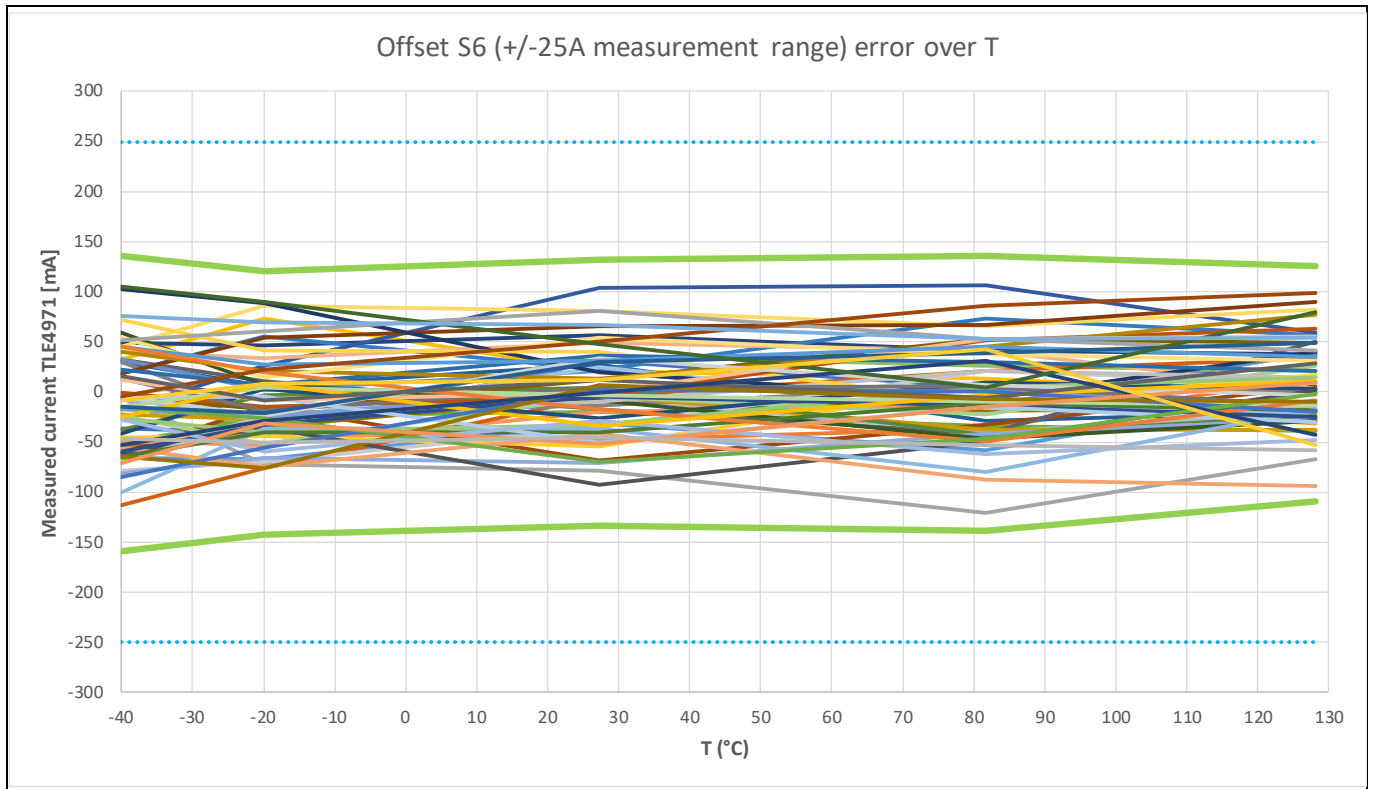

Figure 7 Offset error over T (+/-25A version) with 3 sigma limits in green and 1% limit in dotted blue

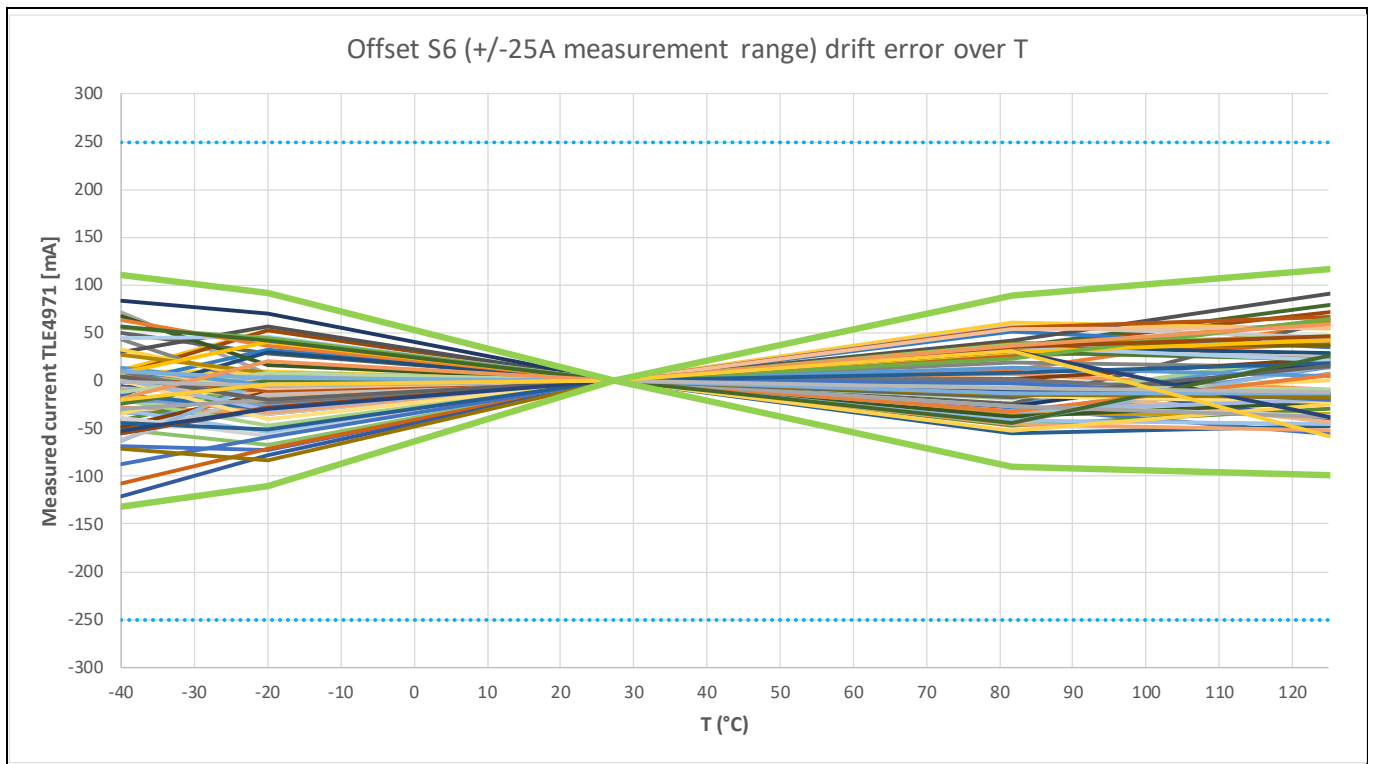

Figure 8 After single point calibration: Offset error over T (+/-25A version) with 3 sigma limits in green and 1% limit in dotted blue

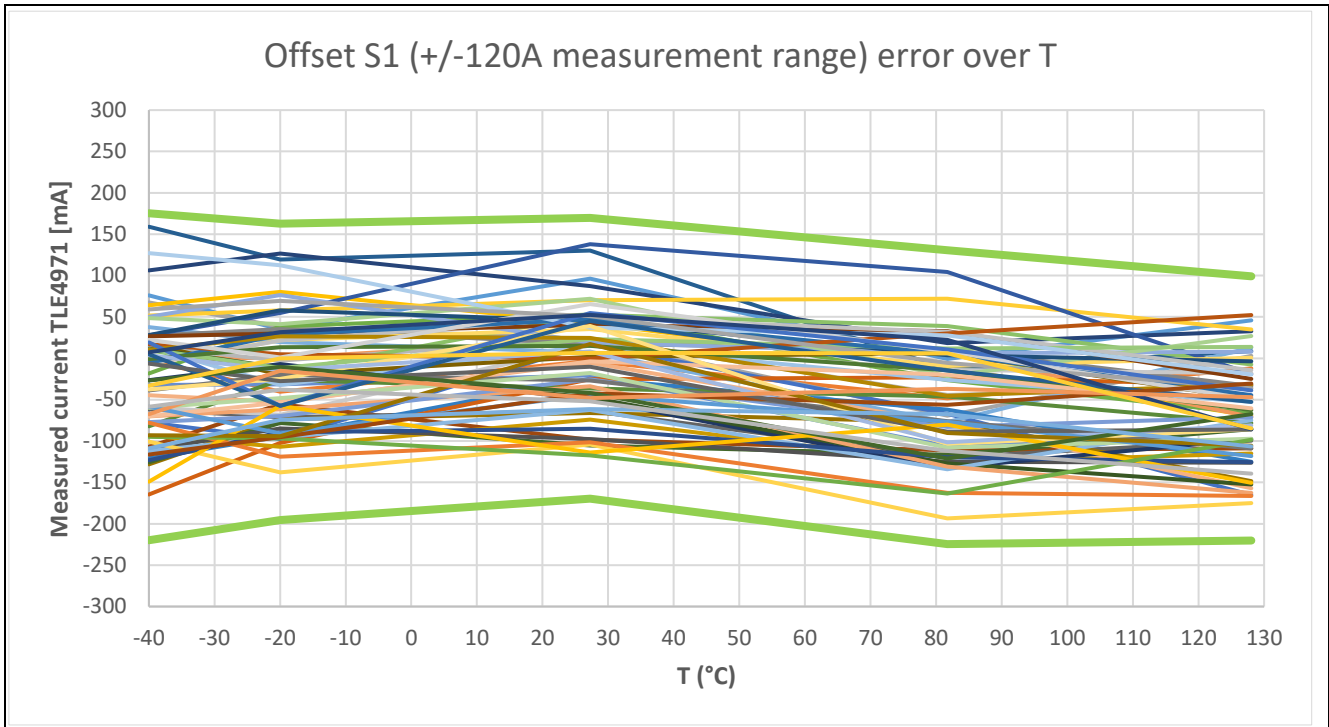

Figure 9 Offset error over T (+/-120A version) with 3 sigma limits in green

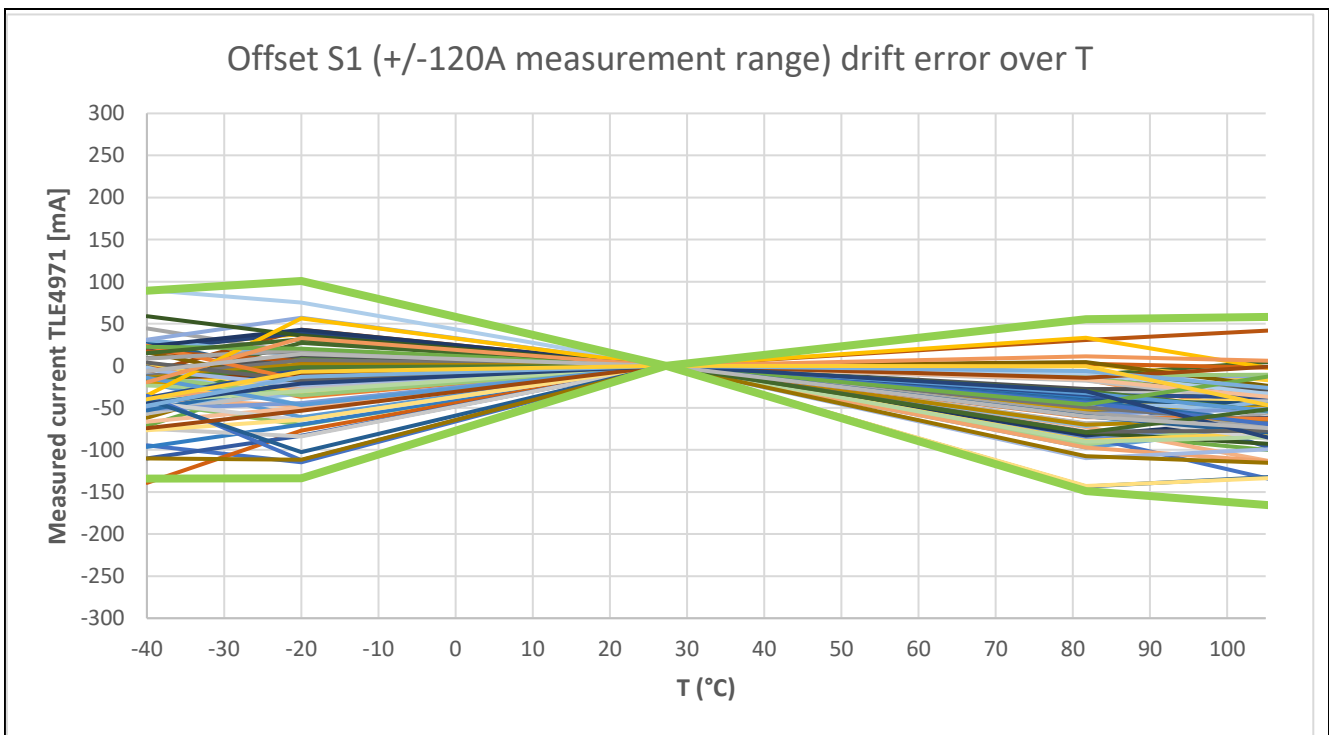

Figure 10 After single point calibration: Offset error over T (+/-120A version) with 3 sigma limits in green

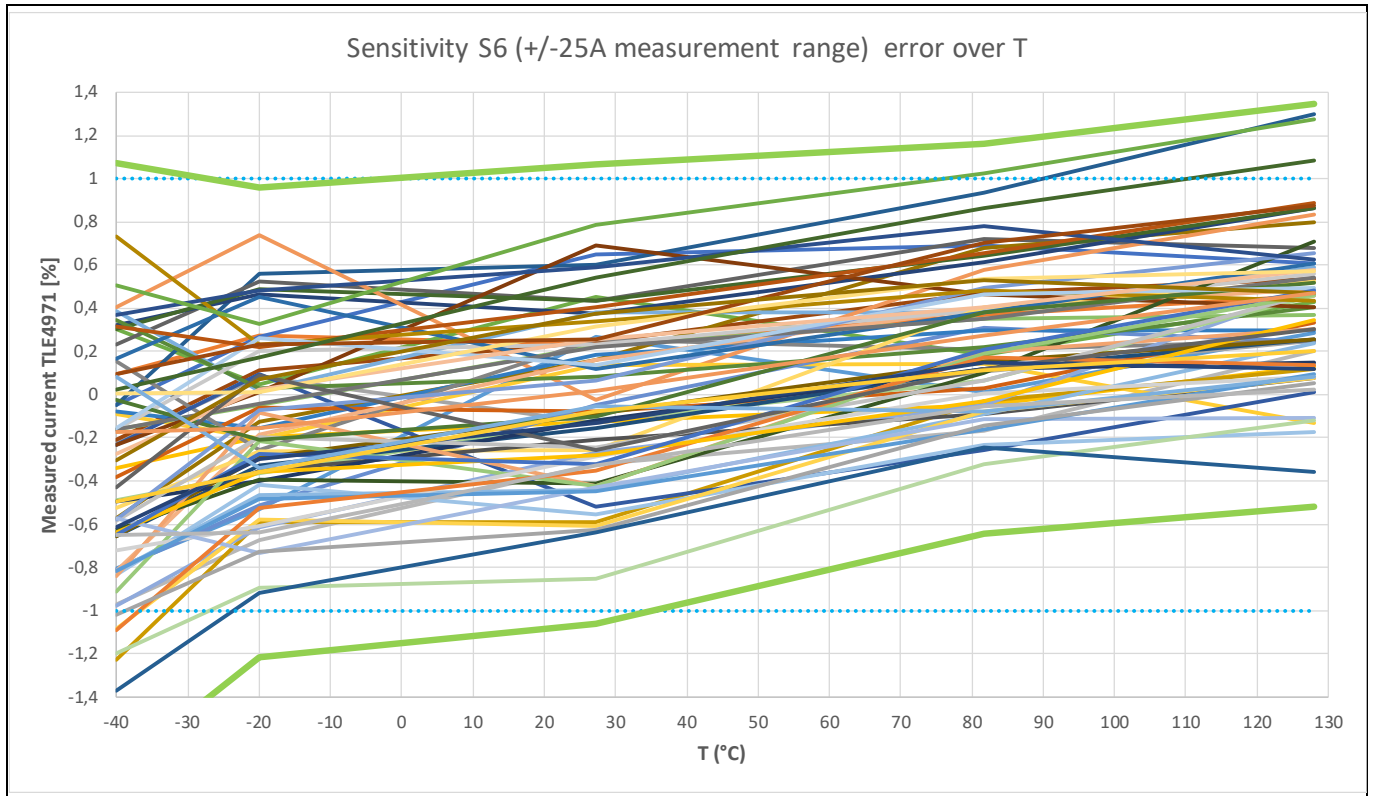

Figure 11 Sensitivity error over T (+/-25A version) with 3 sigma limits in green and 1% limit in dotted blue

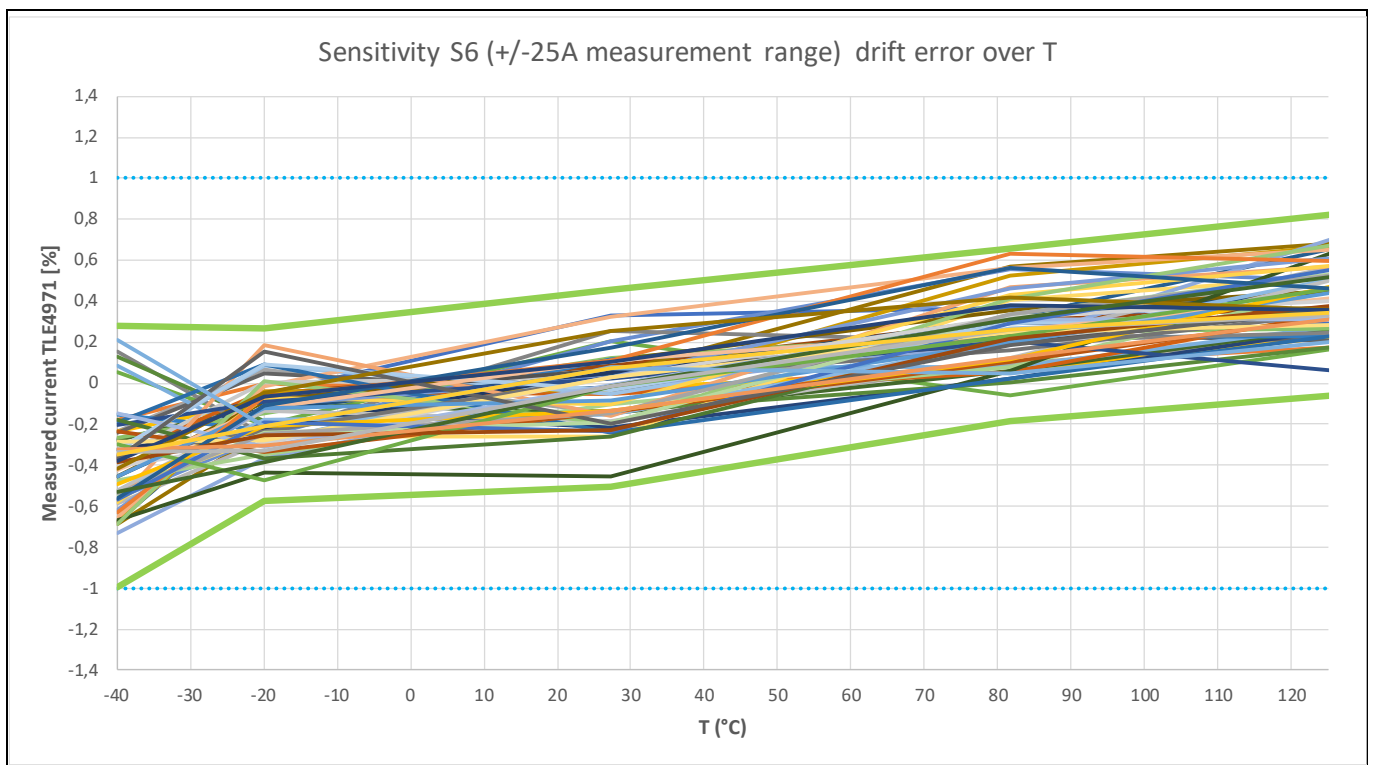

Figure 12 After single point calibration: Sensitivity error over T (+/-25A version) with 3 sigma limits in green and 1% limit in dotted blue

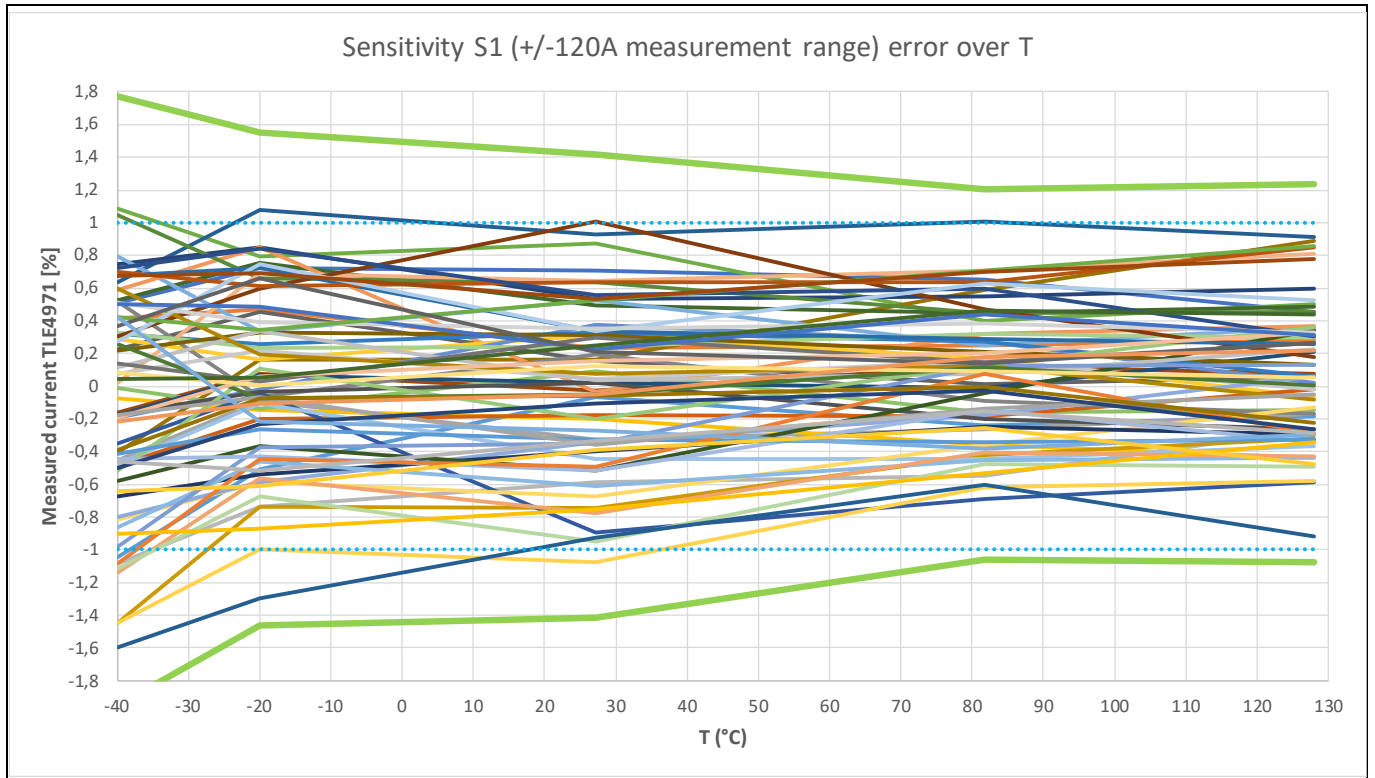

Figure 13 Sensitivity error over T (+/-120A version) with 3 sigma limits in green and 1% limit in dotted blue

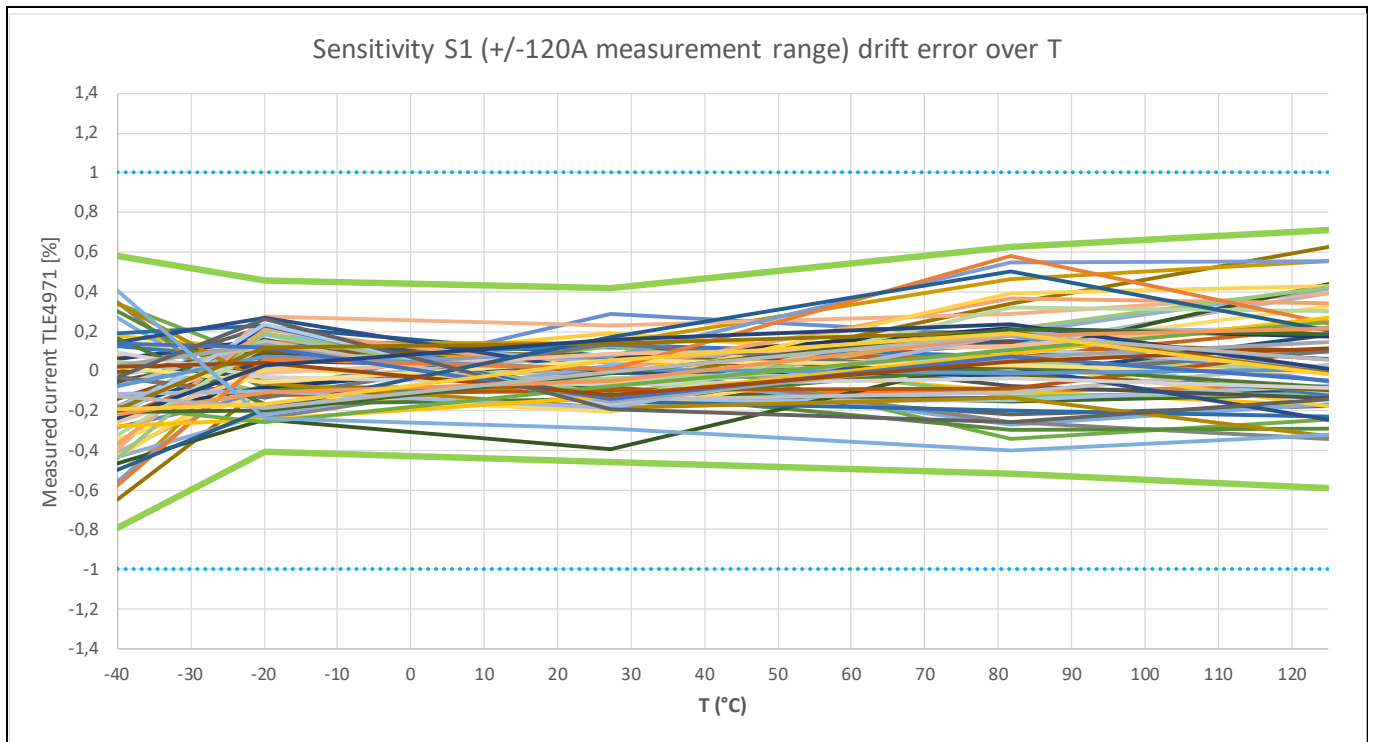

Figure 14 After single point calibration: Sensitivity error over T (+/-120A version) with 3 sigma limits in green and 1% limit in dotted blue

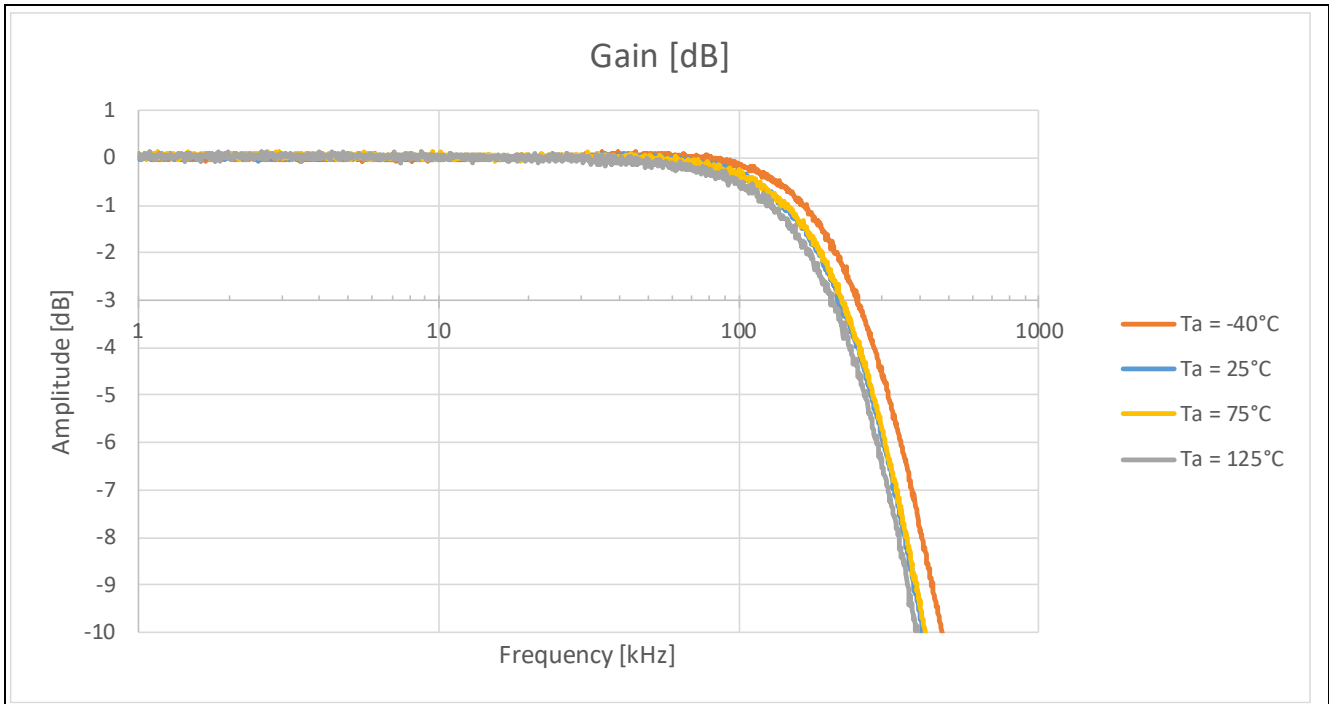

Figure 15 Typical amplitude over frequency

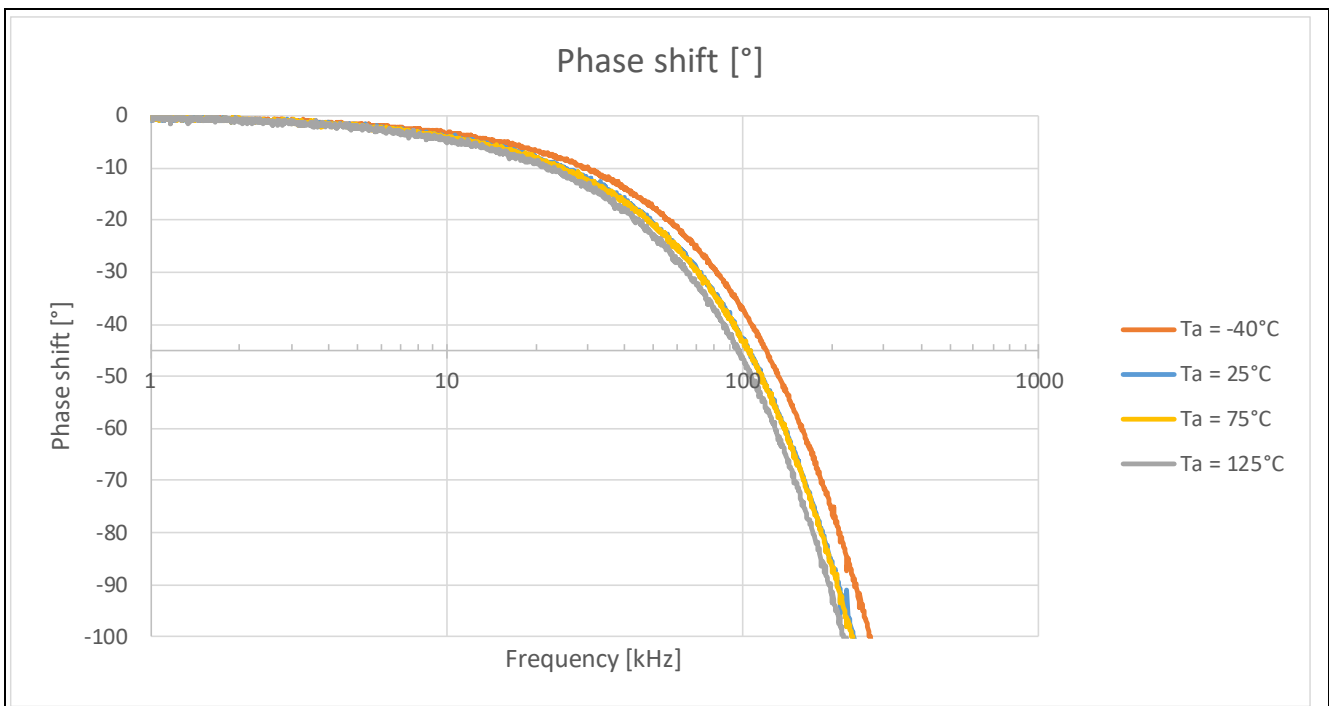

Figure 16 Typical phase-shift over frequency

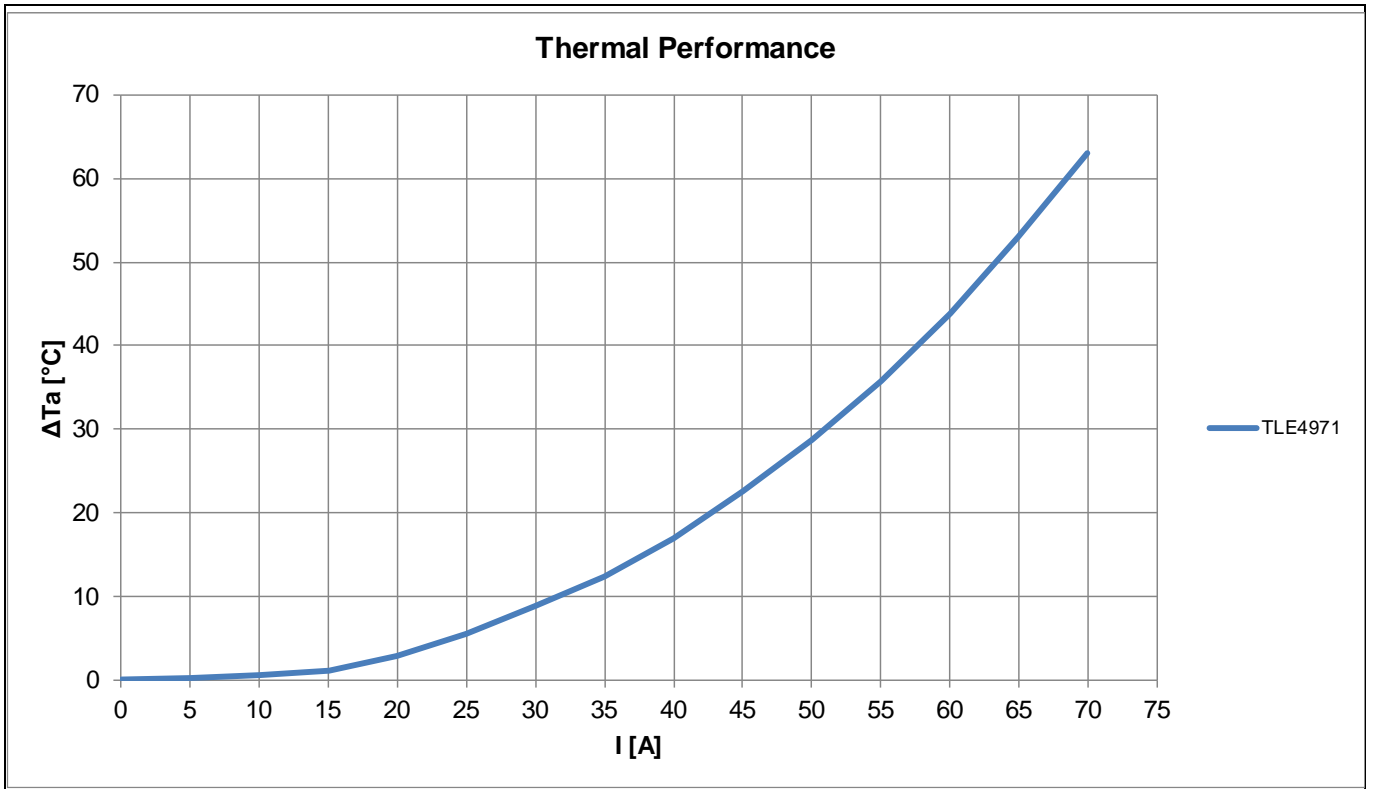

Figure 17 Typical steady state temperature increase

Package

The TLE4971 is packaged in a RoHS compliant, halogen-free leadless package (QFN-like). The package TISON-8-6 includes a lead tip inspection edge on both sides to enable the customer for easy solder quality check of its assembled board.

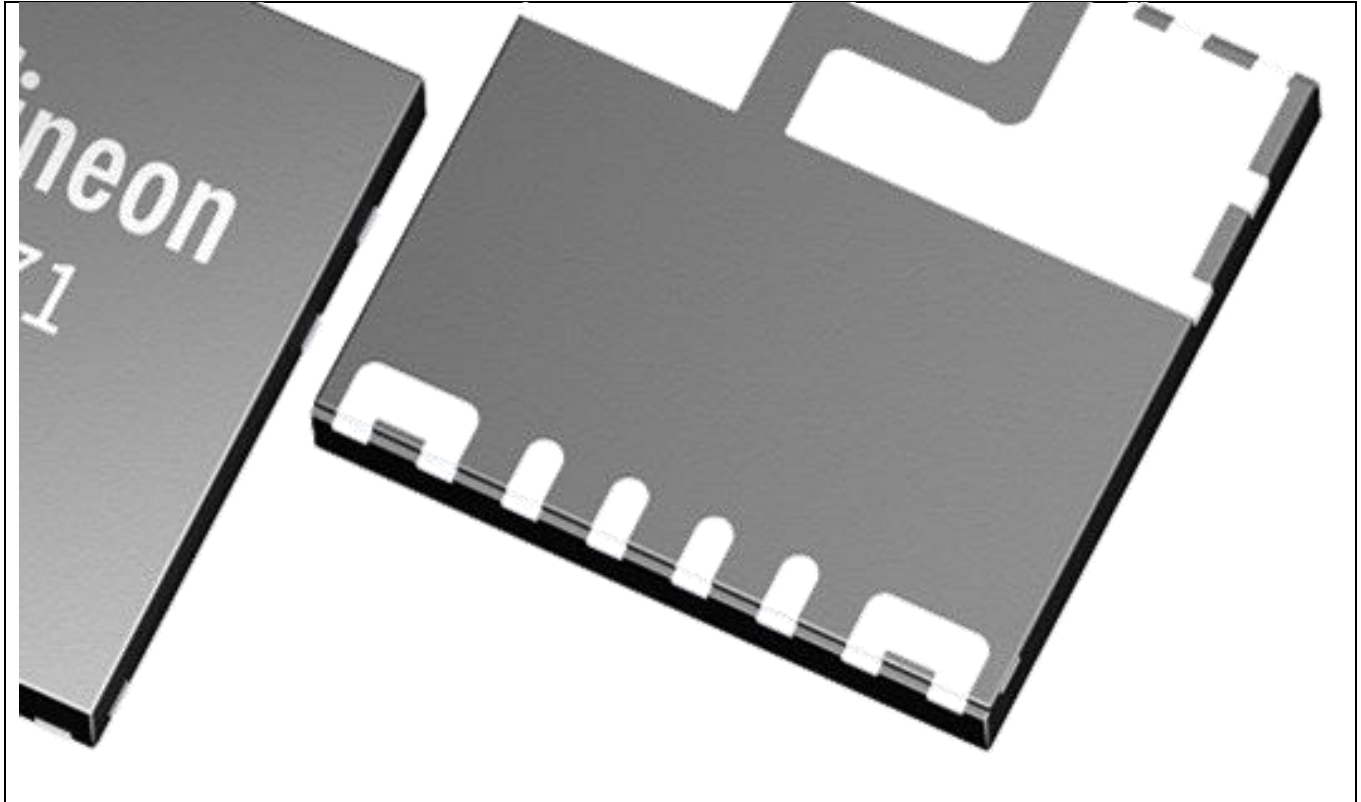

Figure 18: Lead Tip Inspection edge of the TISON-8-6 package

Dimensions:

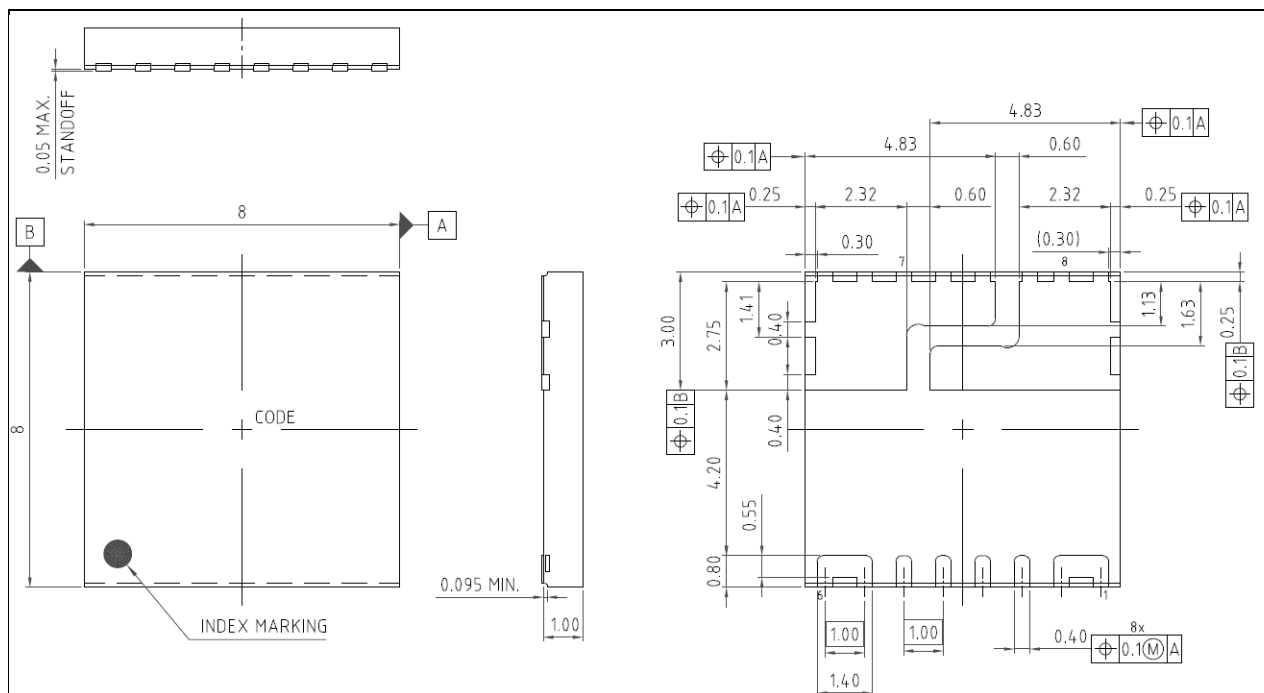

Figure 20: PG-TISON-8-6 package dimensions

Revision History

Major changes since the last revision

Date	Description of change
12-01-2023	V1.00
	Initial version