

User Manual Demo Kit

Li-Ion Battery Monitoring and Balancing IC

About this document

User Manual for multi-cell monitoring and balancing ICs TLE9012AQU & TLE9015QU evaluation kits designed for Li-ion battery packs used in hybrid electric vehicles (HEV), plug-in hybrid electric vehicles (PHEV), battery electric vehicles (BEV) as well as in stationary Lithium-Ion batteries.

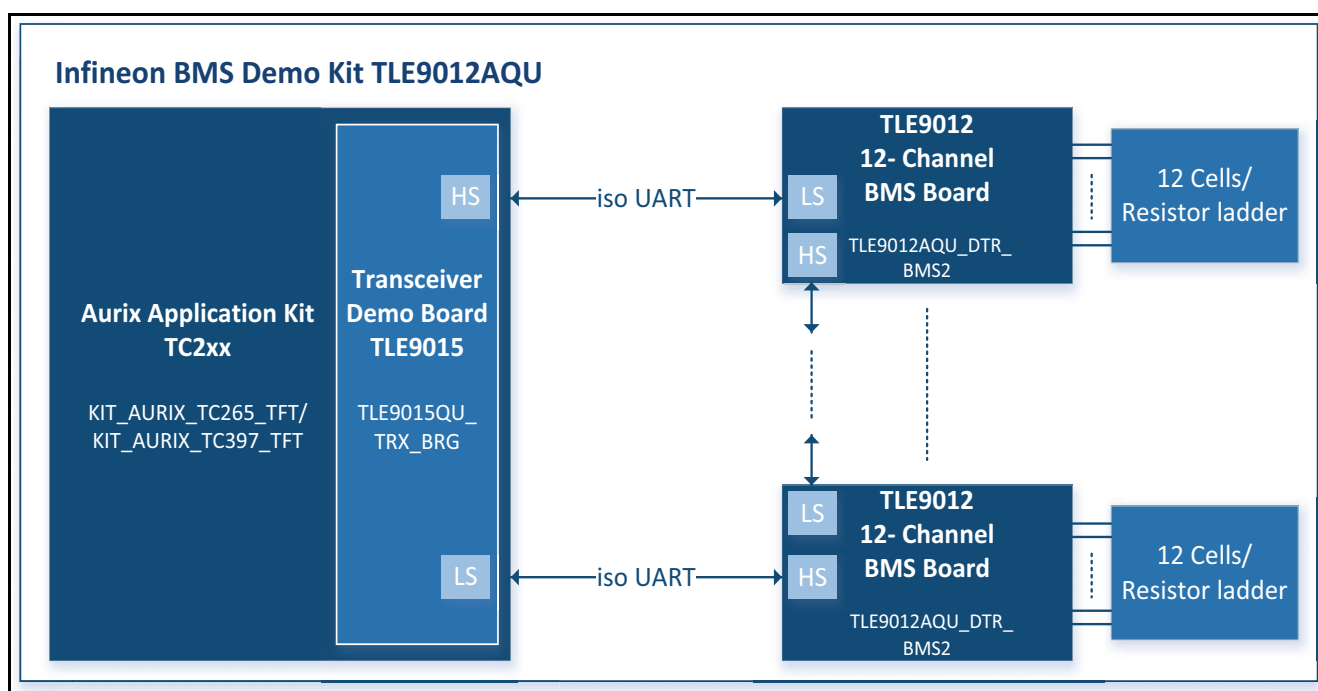

Figure 1 Demo Kit BMS



Table of Contents

	About this document	1
	Table of Contents	2
1	Getting started	3
1.1	Hardware elements of the Demo Kit	3
1.2	Hardware connection	3
1.3	13 wire setup	4
1.4	Flashing the AURIX™ hardware kit	5
1.4.1	DAS tool	5
1.4.2	Memtool	5
1.4.3	Flash the AURIX™	5
2	Terminal	10
3	Revision History	12

Getting started

1 Getting started

1.1 Hardware elements of the Demo Kit

Note: All different versions of the evaluation boards are compatible to each other and can be used in the same daisy chain.

The following hardware is necessary to start with the TLE9012AQU Demo Kit:

- TLE9012AQU Demo Board
- at least 1x iso UART cable
- 1x resistor ladder (not necessary in evaluation board V5)
- TLE9015QU Transceiver Board
- AURIX™ TC265 TFT Application Kit
- 12 V power supply
- USB cable
- Power supply for resistor ladder (5 V - 60 V)
- optional: 12 Li-Ion cells (instead of resistor ladder)

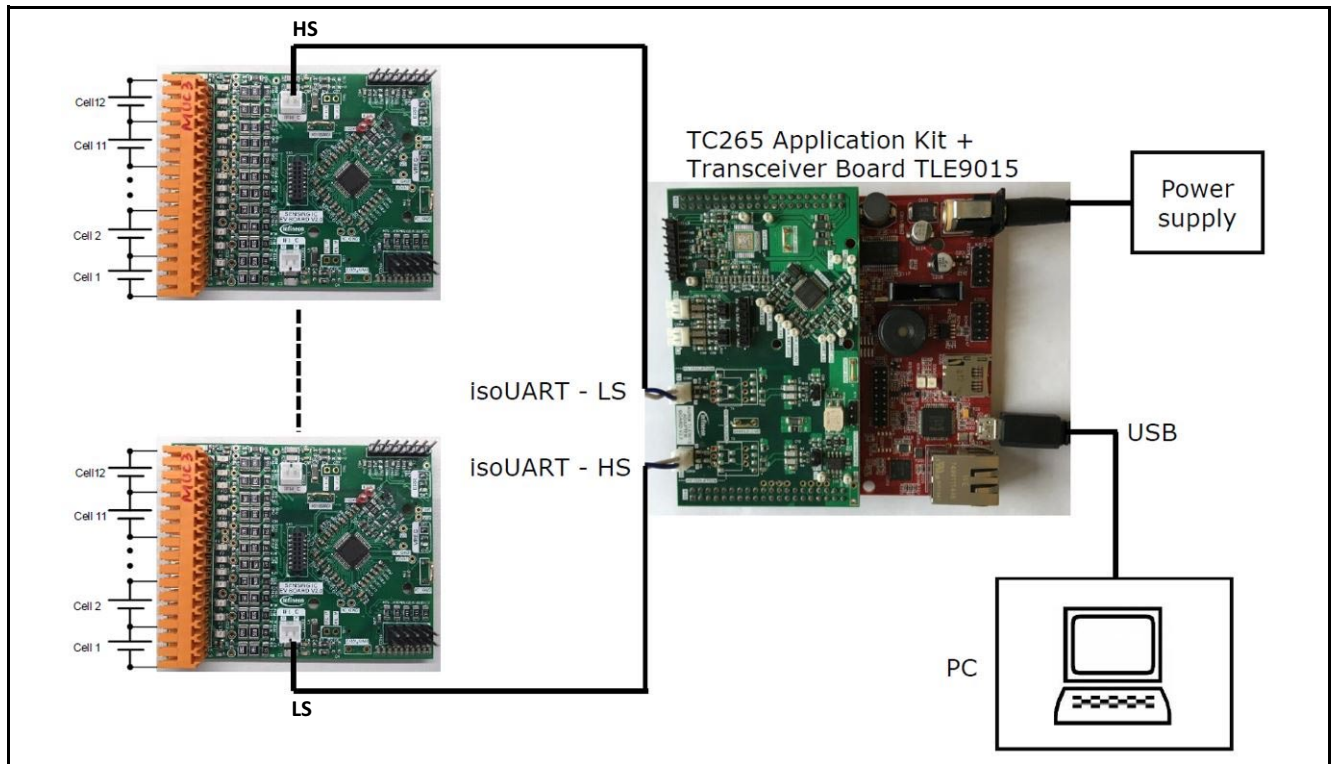

Figure 2 Demo Kit BMS

1.2 Hardware connection

The hardware is connected as follow:

- The TLE9015QU transceiver board is plugged onto the AURIX™ board (orientation as is [Figure 2](#)/[Figure 3](#))

Getting started

- Resistor ladder (cable with orange connector) is connected to the TLE9012AQU demo board (orange connector) as shown in **Figure 3** on the left side. In V5 of the evaluation kit, the resistor ladder is included on the PCB and connected through a solder bump.
- Supply the resistor ladder with a voltage between 5 V - 60 V
- Supply the AURIX™ board with the 12 V power supply and connector it via the USB cable with the PC
- Use the iso UART cable (blue/white) cable to connect the transceiver board with the sensing board as shown in **Figure 3**

Note: The sensing IC board can be connected either to cells or to a power supply with provided resistor ladder (orange connector with red/black cable). If a resistance divider is used, an open load error is detected and the corresponding bit in the diagnosis register (GEN_DIAG) is set (because of that also cell balancing cannot be activated). This is because the internal resistance of Li-Ion cells is much smaller than that of the resistors on the resistor divider. All other functions such as cell voltage measurement, temperature etc. are possible without restriction.

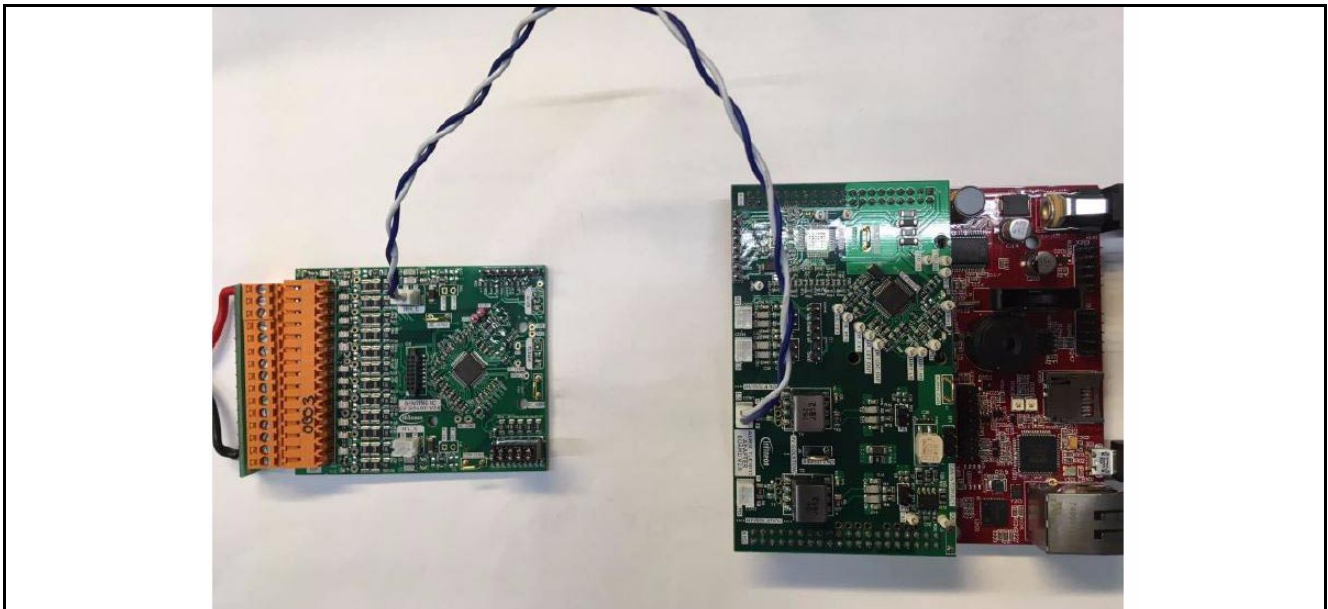

Figure 3 Hardware setup

1.3 13 wire setup

The BMS sensing board can be used in a 13 wire or 15 wire setup (see details in App Note HW). For a 13 wire setup, solder R13 and R29 with a 0 Ω resistor (0603 package) as described in **Figure 4**.

Getting started

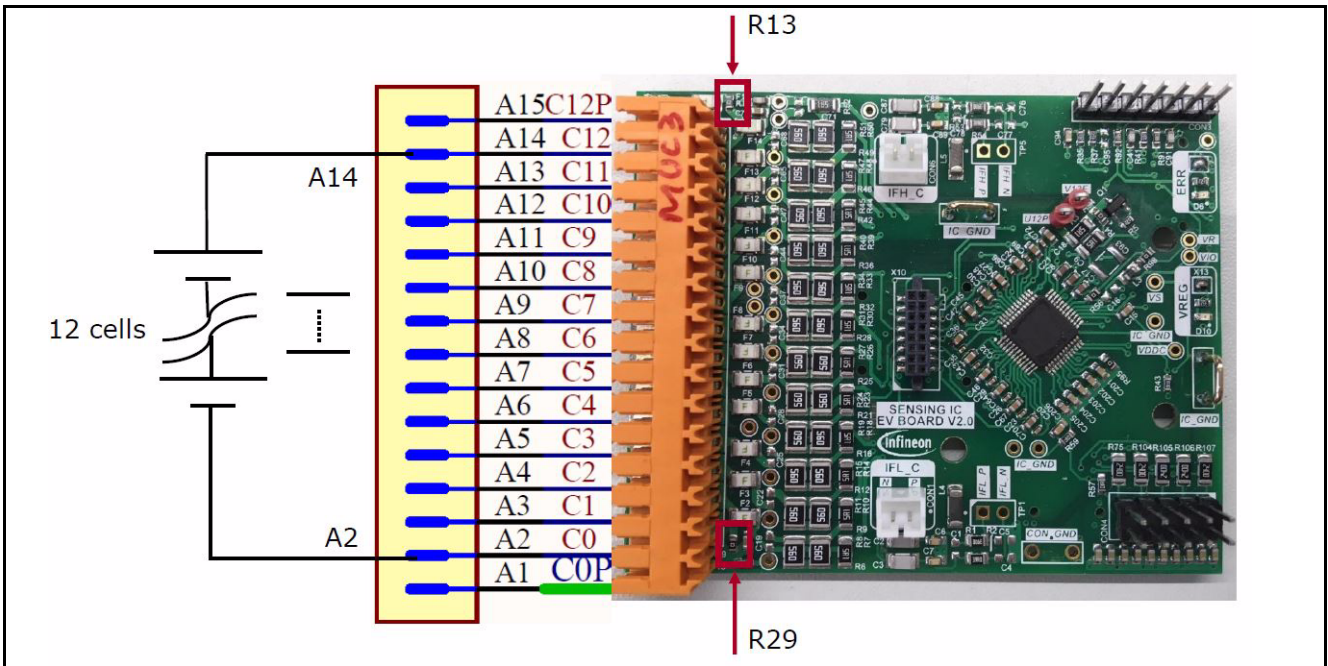

Figure 4 13 wire setup

1.4 Flashing the AURIX™ hardware kit

The following steps are required to setup the framework for the Demo Kit.

1.4.1 DAS tool

The DAS tool is a USB driver software provided by Infineon. It is required to connect the AURIX™ hardware kit to the PC environment.

The latest version v7.1.8 can be found here:

[Link to DAS tool](#)

To start the installation, administrator privileges are requirement and the terms of use need to be accepted. After successful installation of DAS, the PC should be able to detect the AURIX™ kit under the com port settings in the device manager.

1.4.2 Memtool

The Memtool is a software from Infineon for on-chip flash programming.

The latest version v4.8.1 can be found here:

[Link to Memtool](#)

Click “Accept & Open” to download the software and run the installation afterwards.

1.4.3 Flash the AURIX™

The AURIX™ kit needs to be connected to a 12 V power supply. A USB cable connects the board to the PC.

Getting started

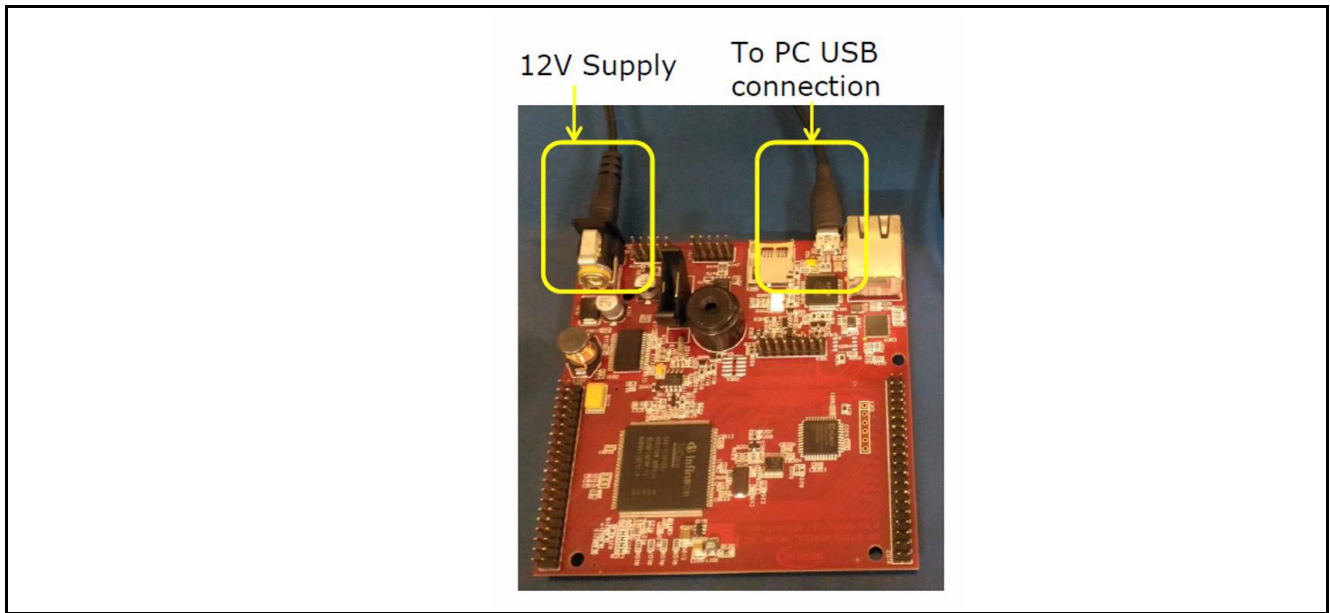

Figure 5 AURIX™ power supply and USB connection

Press “START” button to initialize.

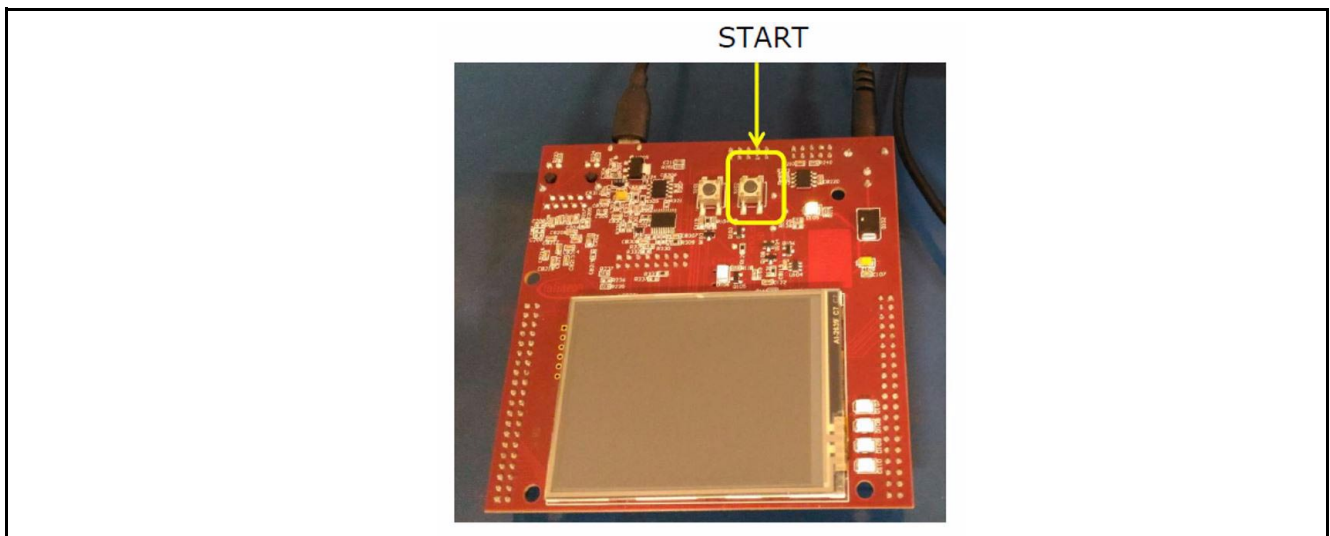

Figure 6 AURIX™ initialize

Open the device manager and expand “Universal Serial Bus controllers”. Right click on “Infineon DAS JDS COM” to open the properties. Select the tab “Advanced”, check “Load VCP” and click “OK”.

Getting started

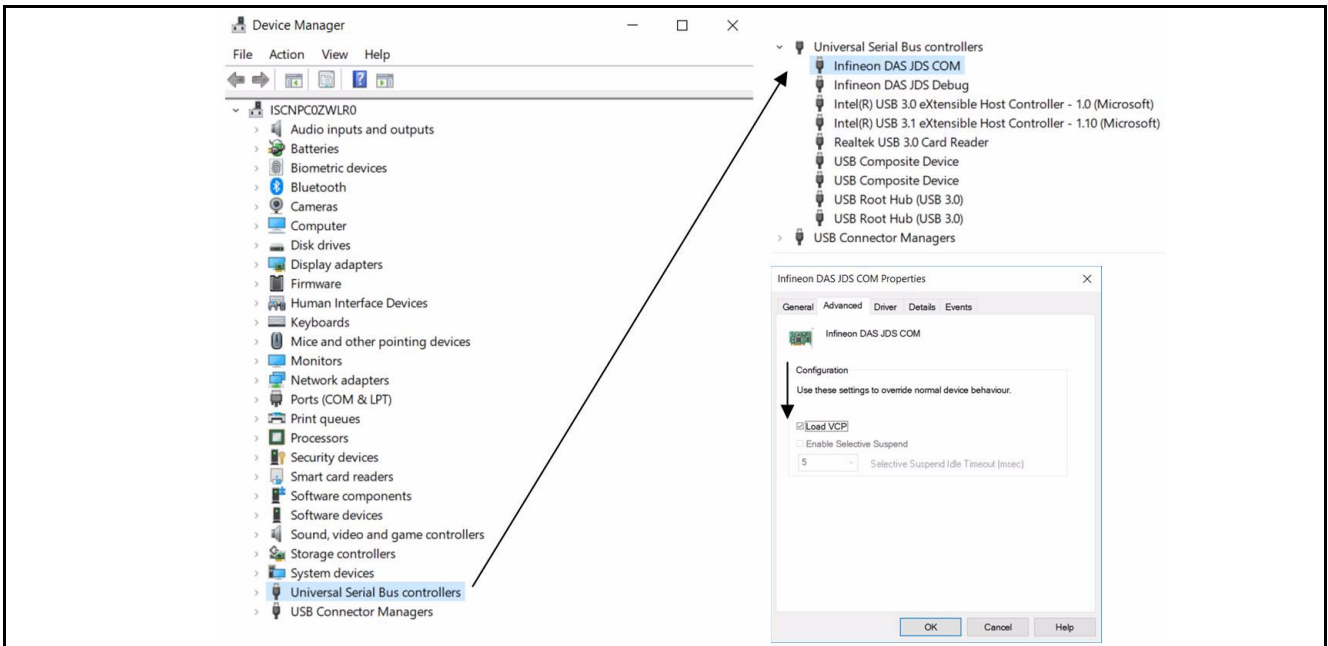

Figure 7 Configuration of the COM port

Disconnect the USB cable and power supply and reconnect. After pressing “START”, check the COM port number in the device manager by expanding “Ports (COM & LPT)”. A port number is assigned to the AURIX™ kit.

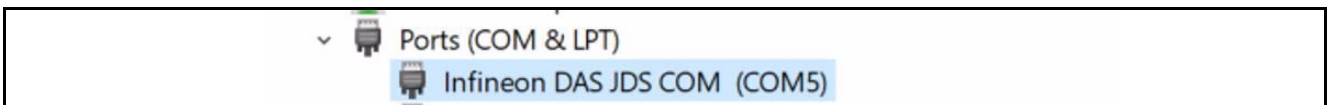

Figure 8 Infineon DAS JDS COM port

Open the Memtool got to “Target” -> “Change...”.

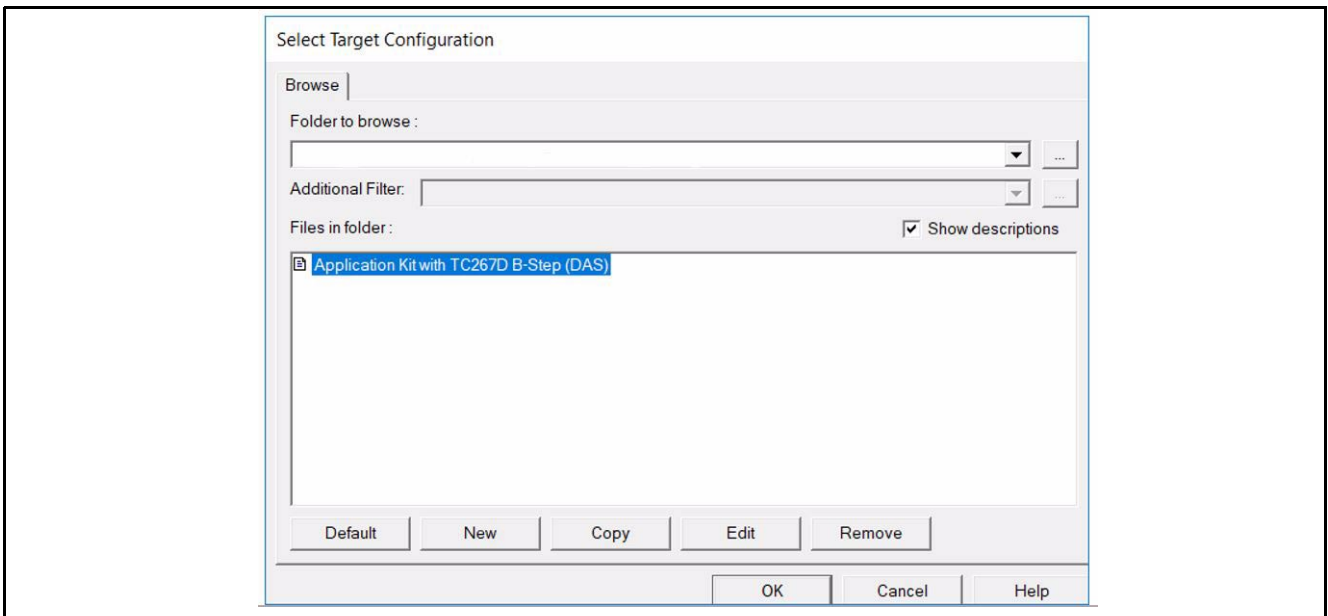

Figure 9 Select Target Configuration

Click on “New” and select “Use a default target configuration”. Expand “TriCore Aurix” -> “Application Kits (DAS)”. Select “Application Kit with TC267D B-Step(DAS)” as shown in **Figure 10**.

Getting started

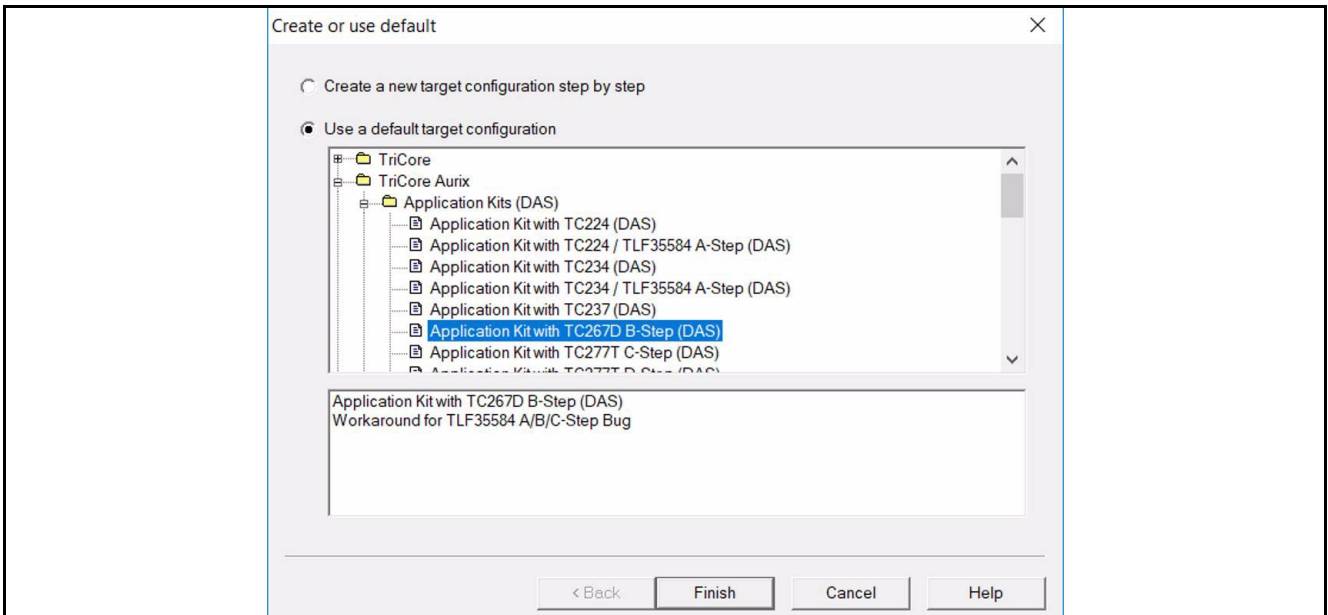

Figure 10 Create or use default

Click “Finish” and save the target configuration file then select “OK”. After selecting the target configuration, click on “Connect”. If connection is successful, you will be able to see this message “ready for Memtool Command”. Click on “Open File ...”.

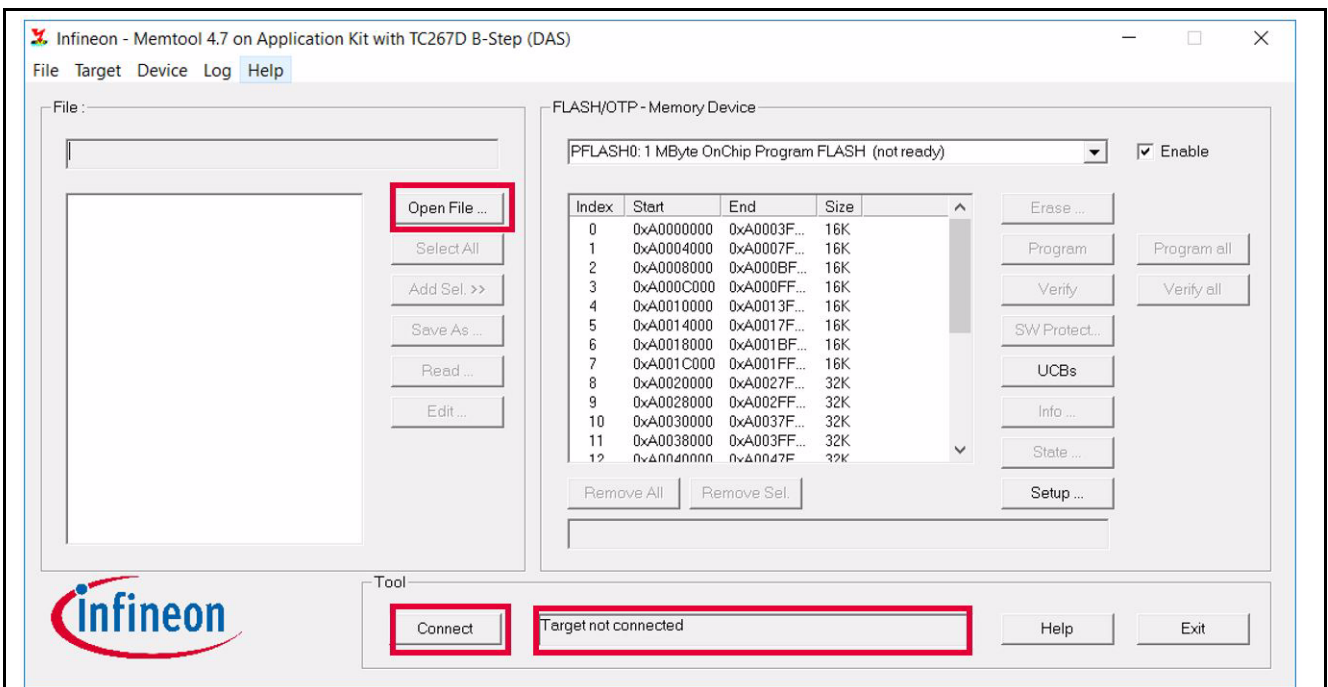

Figure 11 Memtool

Select the *.hex file “TLE9015QU_TLE9012AQU_Aurix1G_v3_Tricore.hex” stored on the USB stick. Click “Select All” and afterwards “Add Sel”. To flash the AURIX™ select “Program all”. Once successful, you can see the message shown in [Figure 12](#).

Getting started

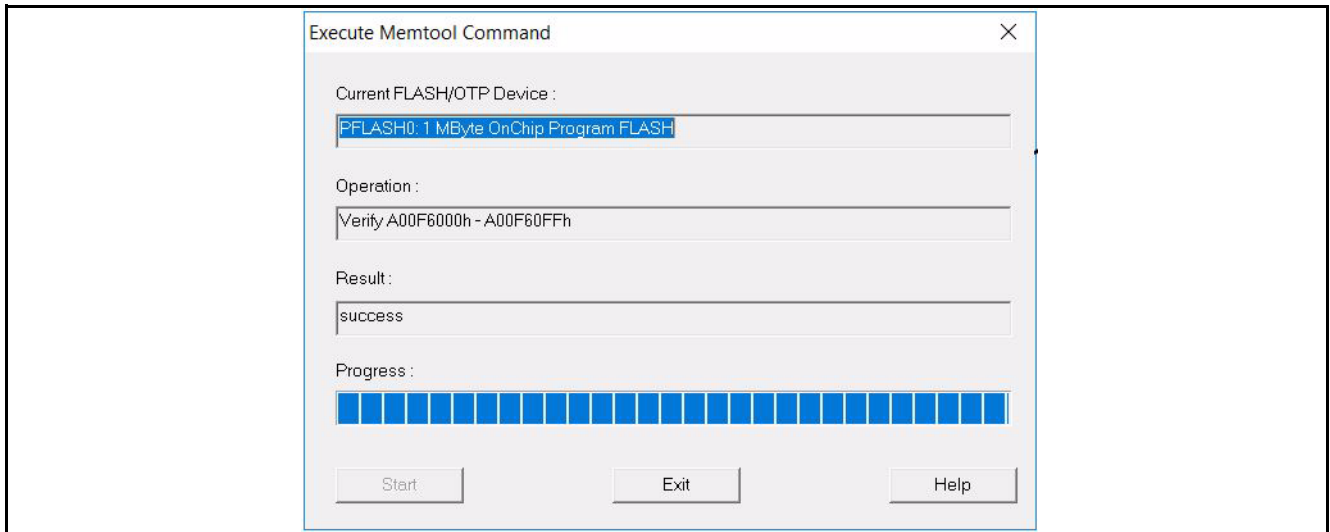

Figure 12 Execute Memtool command

Note: For further details or support on how to flash the AURIX™ TFT kit, please refer to <https://www.infineon.com/aurix>

Terminal

2 Terminal

A terminal program (e.g. TeraTerm) can be used to communicate with the BMS IC. The configuration of the serial port is shown in [Figure 13](#).

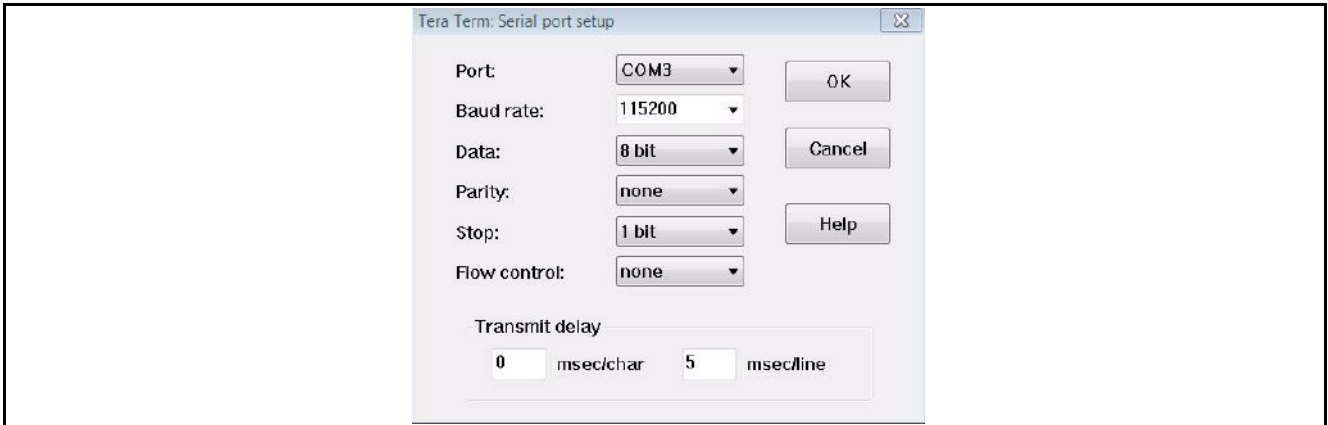

Figure 13 Serial port setup

After successful configuration, a user manual is available by sending “?”.

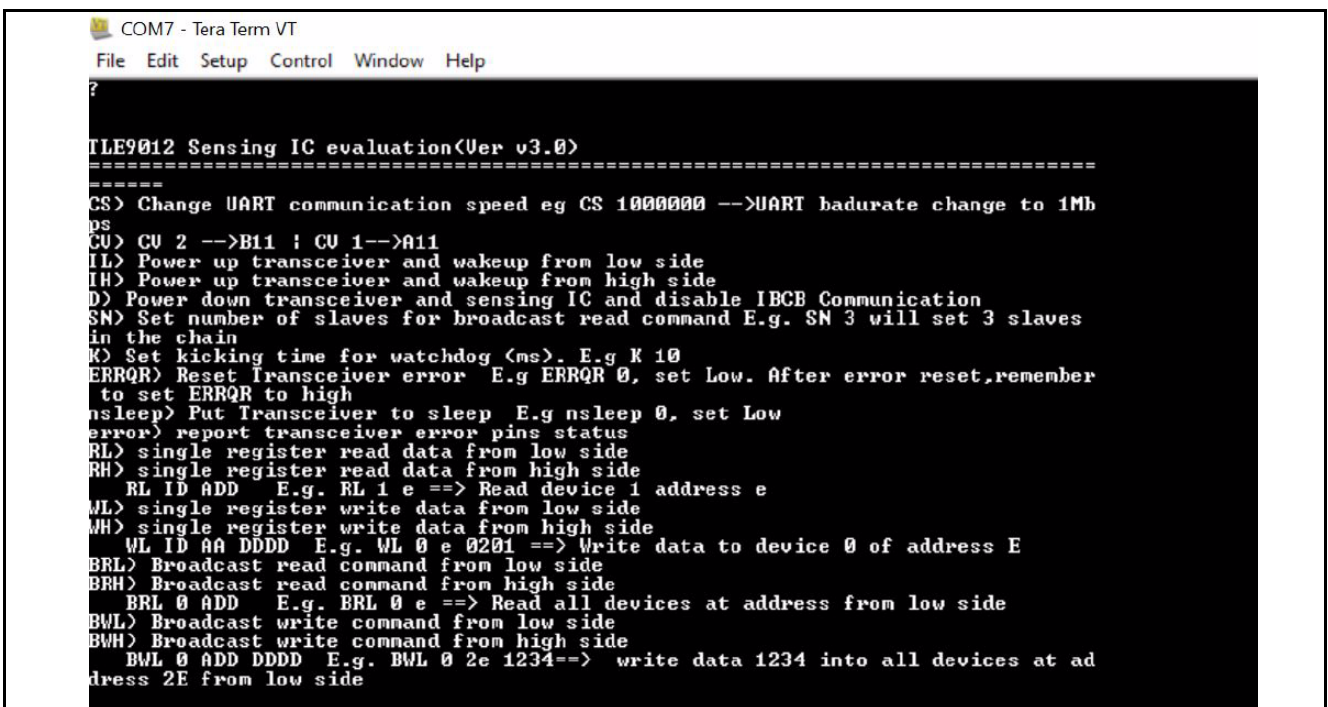

Figure 14 User manual

There is the possibility to load a script into the terminal, which will perform several lines of commands. Drag & drop can be used to load the script in the terminal. A script, which reads out all the cell voltage is provided on the USB stick “TC265TFT_BMS_init_CVM_1_Slave_Terminal.txt”.

Terminal

```

IL
IL OK
K 500
Watchdog kicking time change to 500 ms
WL 0 36 8001
WL 0 36 00000b OK 8002
wl 1 1 0FFF
WL 1 01 00000b OK 8002
wl 1 b 8000
WL 1 0b 000000 OK 8000
rl 1 b
RL 1 0b 000002 OK 8000
wl 1 18 ee21
WL 1 18 000000 OK 8000
rl 1 24
RL 1 24 0055a7 OK 8000
rl 1 23
RL 1 23 0055b2 OK 8000
rl 1 22
RL 1 22 005586 OK 8000
rl 1 21
RL 1 21 0055a9 OK 8000
rl 1 20
RL 1 20 005594 OK 8000
rl 1 1f
RL 1 1f 0055ad OK 8000
rl 1 1e
RL 1 1e 00559c OK 8000
rl 1 1d
RL 1 1d 00558b OK 8000
rl 1 1c
RL 1 1c 005593 OK 8000
rl 1 1b
RL 1 1b 0055b6 OK 8000
rl 1 1a
RL 1 1a 0055ab OK 8000
rl 1 19
RL 1 19 0055a8 OK 8000
    
```

Figure 15 Terminal script to read out all CVMs

The result registers can be copied into an Excel sheet to calculate the cell voltages (in mV) out of the hex register values. Therefore, the lines shown in Figure 15 need to be marked and copied by selecting “Edit” -> “Copy table”.

Based on the “C265TFT_BMS_init_CVM_1_Slave_Terminal.txt” file is an Excel sheet on the USB stick available to calculate the voltages in mV. The Excel sheet is shown in Figure 16.

	A	B	C	D	E	F	G	H	I
1	IC Nr. xxx	Channel	TeraTerm [mV]				Info		
2									
3		12	0,0	0					
4		11	0,0	0					
5		10	0,0	0					
6		9	0,0	0					
7		8	0,0	0					
8		7	0,0	0					
9		6	0,0	0					
10		5	0,0	0					
11		4	0,0	0					
12		3	0,0	0					
13		2	0,0	0					
14		1	0,0	0					

Figure 16 TLE9012AQU_CVM.xlsx Excel sheet to calculate the cell voltages in mV



Revision History

3 Revision History

Revision	Date	Changes
1.0	2020-06-04	Initial User Manual