

Features & Benefits

- Integrated current rail with typical 220 $\mu\Omega$ insertion resistance enables ultra-low power loss
- Less than 1nH parasitic inductance of integrated current rail enables wide bandgap design
- Bandwidth of 240kHz enables wide range of applications
- 8x8mm form factor
- Very low sensitivity error over temperature
- Galvanic functional isolation up to 1150V
- V_{ISO} 3500V RMS agency type-tested for 60 seconds per UL1577
- Differential sensing principle
- Two independent ultrafast Over Current Detection outputs

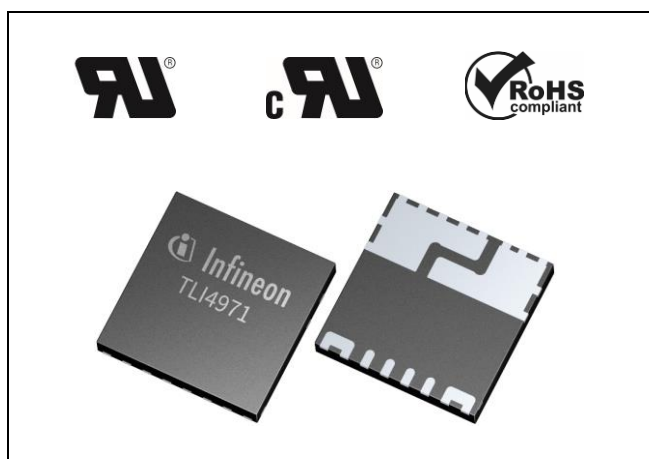

Coreless current sensor in PG-TISON-8 package

Description

TLI4971 is a high precision miniature coreless magnetic current sensor for AC and DC measurements with analog interface and two fast over-current detection outputs.

Infineon's well-established and robust monolithic Hall technology enables accurate and highly linear measurement of currents with a full scale up to $\pm 120\text{A}$. All negative effects (saturation, hysteresis) commonly known from open loop sensors using flux concentration techniques are avoided. The sensor is equipped with internal self-diagnostic feature.

Typical applications are electrical drives and general purpose inverters.

The differential measurement principle allows great stray field suppression for operation in harsh environments.

Two separate interface pins (OCD) provide a fast output signal in case a current exceeds a pre-set threshold.

The sensor is shipped as a fully calibrated product without requiring any customer end-of-line calibration.

All user-programmable parameters such as OCD thresholds, blanking times and output configuration modes are stored in an embedded EEPROM memory.

Order Information

Product Name	Product Type	Marking	Ordering Code	Package
TLI4971-A120T5-U-E0001	120A measurement range, UL certified device ¹⁾²⁾	H71I1A1UH	SP005272936	PG-TISON-8
TLI4971-A120T5-E0001	120A measurement range ¹⁾²⁾	H71I1A1_H	SP005344532	PG-TISON-8
TLI4971-A075T5-U-E0001	75A measurement range, UL certified device ¹⁾²⁾	H71I3A1UH	SP005446655	PG-TISON-8
TLI4971-A075T5-E0001	75A measurement range ¹⁾²⁾	H71I3A1_H	SP005446653	PG-TISON-8
TLI4971-A050T5-U-E0001	50A measurement range, UL certified device ¹⁾²⁾	H71I4A1UH	SP005446651	PG-TISON-8
TLI4971-A050T5-E0001	50A measurement range ¹⁾²⁾	H71I4A1_H	SP005446648	PG-TISON-8
TLI4971-A025T5-U-E0001	25A measurement range, UL certified device ¹⁾²⁾	H71I6A1UH	SP005446646	PG-TISON-8
TLI4971-A025T5-E0001	25A measurement range ¹⁾²⁾	H71I6A1_H	SP005446644	PG-TISON-8

1) Current sensor for industrial / consumer applications, qualified according to AEC Q100 grade 2

2) Semi-differential mode, non-ratiometric output sensitivity

Pin Configuration

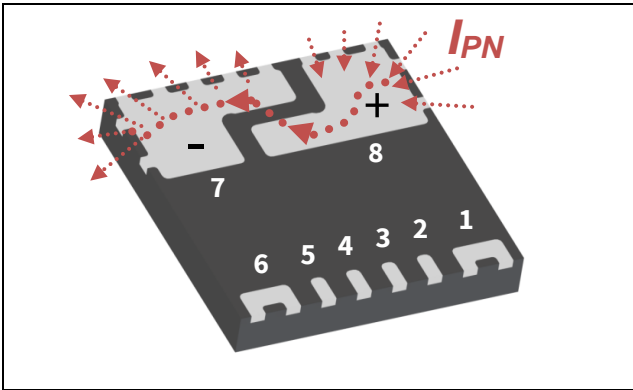

Figure 1 Pin layout PG-TISON-8-5

The current I_{PN} is measured as a positive value when it flows from pin 8 (+) to pin 7 (-) through the integrated current rail.

Pin configuration

Pin No.	Symbol	Function
1	VDD	Supply voltage
2	GND	Ground
3	VREF	Reference voltage input or output
4	AOUT	Analog signal output
5	OCD1	Over-current detection output 1 (open drain output)
6	OCD2	Over-current detection output 2 (open drain output)
7	IP-	Negative current terminal pin (current-out)
8	IP+	Positive current terminal pin (current-in)

Target Applications

The TLI4971 is suitable for AC as well as DC current measurement applications:

- Electrical drives
- General purpose inverters
- PV inverters
- Chargers
- Current monitoring
- Overload and over-current detection

Due to its implemented magnetic interference suppression, it is extremely robust when exposed to external magnetic fields. The device is suitable for fast over-current detection with a configurable threshold level. This allows the control unit to switch off and protect the affected system from damage, independently from the main measurement path.

General Description

The current flowing through the current rail on the primary side induces a magnetic field that is differentially measured by two Hall probes. The differential measurement principle of the magnetic field combined with the current rail design provides superior suppression of any ambient magnetic stray fields. A high performance amplifier combines the signal resulting from the differential field and the internal compensation information provided by the temperature and stress compensation unit. Finally the amplifier output signal is fed into a differential output amplifier which is able to drive the analog output of the sensor.

Depending on the selected programming option, the analog output signal can be provided either as:

- Single-ended
- Fully-differential
- Semi-differential

In single-ended mode, the pin VREF is used as a reference voltage input. The analog output signal is provided on pin AOUT. In fully-differential mode, both AOUT (positive polarity) and VREF (negative polarity) are used as signal outputs whereas VDD is used as reference voltage input. Compared to the single-ended mode, the fully-differential mode enables doubling of the output voltage swing.

In semi-differential mode a chip-internal reference voltage is used and provided on VREF (output). The current sensing information is provided in a single-ended way on AOUT.

For fast over-current detection, the raw analog signal provided by the Hall probes is fed into comparators with programmable switching thresholds.

A user-programmable deglitch filter is implemented to enable the suppression of fast switching transients. The open-drain outputs of the OCD pins are active “low” and they can be directly combined into a wired-AND configuration on board level to have a general over-current detection signal.

All user-programmable parameters such as OCD thresholds, deglitching filter settings and output configuration mode are stored in an embedded EEPROM memory.

Programming of the memory can be performed in the application through a Serial Inspection and Configuration Interface (SICI). The interface is described in detail in the programming guide which can be found on the Infineon website. Please contact your local Infineon sales office for further documentation.

Standard Product Configuration

- The pre-configured full scale range is either set to $\pm 120\text{A}$, $\pm 75\text{A}$, $\pm 50\text{A}$ or $\pm 25\text{A}$ depending on the chosen product variant.
- The pre-configured output mode is set to semi-differential mode.
- The quiescent voltage is set to 1.65V.
- The OCD threshold of channel 1 is set to the factor 1.25 of the full scale range.
- The OCD threshold of channel 2 is set to the factor 0.82 of the full scale range.
- The pre-defined setting of the OCD deglitching filter time is set to 0 μs .
- The sensor is pre-configured to work in the non-ratiometric mode.
- The sensitivity and the derived measurement range (full scale) can be reprogrammed by user according to the sensitivity ranges listed in Table 4.
- The sensor can be reprogrammed into single-ended operating mode or fully-differential mode by user without any recalibration of the device.
- The OCD thresholds and filter settings can be reprogrammed by the user according to the values listed in Table 6 and Table 7.
- For semi-differential uni-directional mode or ratiometric output sensitivity, please contact your local Infineon sales office.

Block Diagram

The current flowing through the current rail on the primary side induces a magnetic field, which is measured by two Hall probes differentially. The differential measurement principle provides superior suppression of any ambient magnetic stray fields. A high performance amplifier combines the signal resulting from the differential field and the compensation information, provided by the temperature and stress compensation unit. Finally the amplifier output signal is fed into a differential output amplifier, which is able to drive the analog output of the sensor.

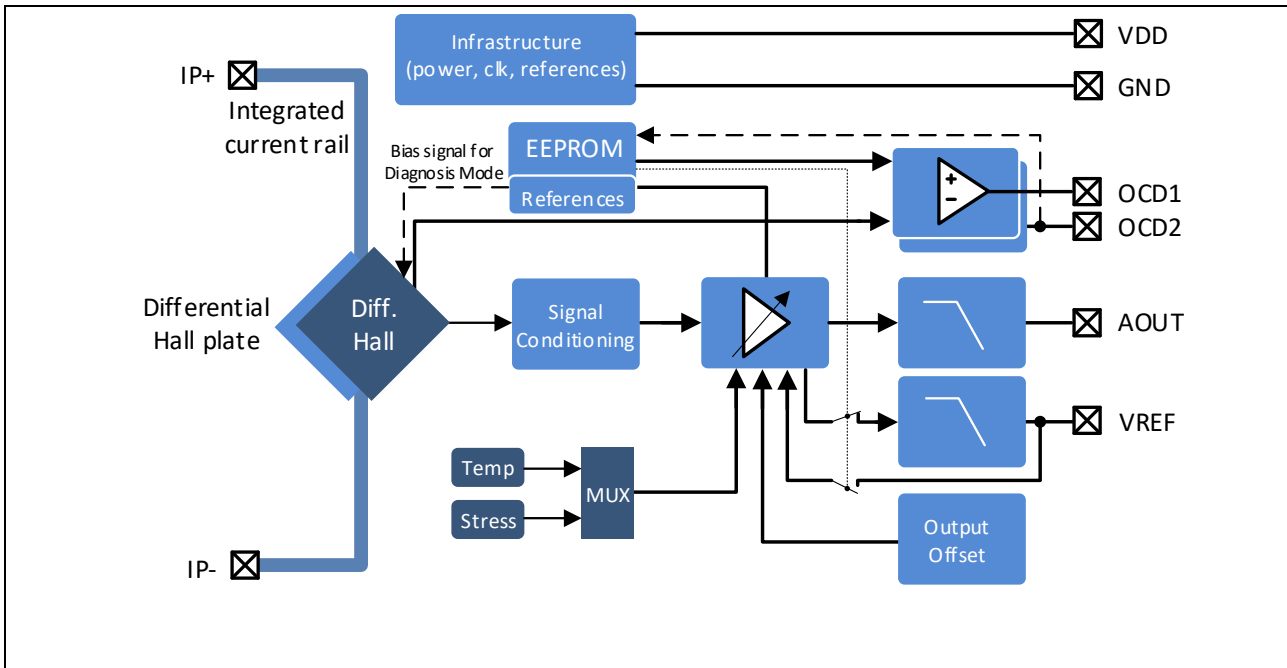

Figure 2 Block Diagram

Absolute Maximum Ratings

Table 1 Absolute Maximum Ratings

General conditions (unless otherwise specified): $V_{DD} = 3.3V$; $T_S = -40^{\circ}C \dots +105^{\circ}C$

Parameter	Symbol	Min	Typ	Max	Unit	Note / Test Condition
Supply voltage	V_{DD}	-0.3	3.3	3.6	V	
Primary nominal rated current LF ¹⁾	I_{PNRLF}	-70	-	70	A	Peak, frequency < 10Hz
Primary nominal rated current HF ¹⁾	I_{PNRHF}	-70	-	70	A	RMS, frequency \geq 10Hz
Primary current	I_{PNS}	-250	-	250	A	Single peak for 10 μ s, 10 assertions per lifetime
Voltage on interface pins VREF, OCD1, AOUT	V_{IO}	-0.3	-	$V_{DD} + 0.3$	V	
Voltage on Interface pin OCD2	V_{IO_OCD2}	-0.3	-	21	V	
ESD voltage ²⁾	V_{ESD_HBM}	-2	-	2	kV	
ESD voltage ³⁾	V_{ESD_SYS}	-16	-	16	kV	In the application circuit
Voltage slew-rate on current rail	$\Delta V/dt$	-	-	10	V/ns	Full voltage range
Maximum junction temperature	T_{J_max}	-	-	130	$^{\circ}C$	
Storage temperature	T_{A_STORE}	-40	-	130	$^{\circ}C$	
Life time	LT	15	-	-	Years	Considering continuous operation with $T_S = 70^{\circ}C$ and $I = 30 A_{RMS}$

1) Tested with primary nominal rated current of 70A peak on Infineon reference PCB at Low Frequency (LF). Thermal equilibrium reached after 2 min.

2) Human Body Model (HBM), according to standard AEC-Q 100-002

3) According to standard IEC 61000-4-2 electrostatic discharge immunity test

Stress above the limit values listed here may cause permanent damage to the device. Exposure to absolute maximum rating conditions for extended periods may affect device reliability. Maximum ratings are absolute ratings. Exceeding only one of these values may cause irreversible damage to the integrated circuit.

Product Characteristics

Table 2 Operating Ranges

General conditions (unless otherwise specified): $V_{DD} = 3.3V$; $T_S = -40^{\circ}C \dots +105^{\circ}C$

Parameter	Symbol	Min.	Typ.	Max.	Unit	Note / Test Condition
Supply voltage	V_{DD}	3.1	3.3	3.5	V	
Ambient temperature at soldering point	T_S	-40	-	105	$^{\circ}C$	Measured at soldering point
Capacitance on analog output pin	C_O	4.7	6.8	8	nF	W/o decoupling resistor, including parasitic cap on the board
Capacitor on VDD	C_{VDD}	-	220	-	nF	
Reference input voltage	V_{REF}	-	1.65	-	V	Default value is semi-differential mode. Other values available by EEPROM: 1.2V, 1.5V, 1.8V
Reference input voltage variation	V_{REF_var}	-10	-	10	%	
EEPROM programming voltage	V_{IO_PRG}	20.5	-	21.0	V	

Table 3 Operating Parameters

General conditions (unless otherwise specified): $V_{DD} = 3.3V$; $T_S = -40^{\circ}C \dots +105^{\circ}C$

Parameter	Symbol	Min.	Typ.	Max.	Unit	Note / Test Condition
Current consumption	I_{DD}	-	18	25	mA	$I(AOUT) = 0mA$
Primary path resistance	R_{PN}	-	220	-	$\mu\Omega$	$25^{\circ}C$, when soldered on PCB with $140\mu m$ copper thickness
Power-on delay time	t_{POR}	-	1.0	1.5	ms	From V_{DD} rising above $V_{DD(min)}$ to full operation. 0A primary input current.
Voltage on interface pin OCD1	V_{IO_OCD1}	-0.3	-	3.5	V	
Voltage on interface pin OCD2	V_{IO_OCD2}	-0.3	-	3.5	V	In functional mode
Voltage on analog output AOUT	V_{AOUT}	-0.3	-	$V_{DD} + 0.3$	V	
Undervoltage/overvoltage lockout delay	t_{UVLOe}	1	2.4	3	μs	Enabled to disabled
Thermal resistance ¹⁾	R_{THJS}	-	0.25	-	K/W	Current rail to soldering point, on Infineon reference PCB (see related application note AppNote TLI4971 PCB)

1) Not subject to production test. Verified by design and characterization.

Functional Output Description

The analog output signal depends on the selected output mode:

- Single-ended
- Fully-differential
- Semi-differential

Single-Ended Output Mode

In single-ended mode VREF is used as an input pin to provide the analog reference voltage, V_{REF} . The voltage on AOUT, V_{AOUT} , is proportional to the measured current I_{PN} at the current rail:

$$V_{AOUT}(I_{PN}) = V_{OQ} + S \cdot I_{PN}$$

The quiescent voltage V_{OQ} is the value of V_{AOUT} when $I_{PN}=0$. V_{OQ} tracks the voltage on VREF

$$V_{OQ}(V_{REF}) = V_{REF}$$

The reference voltage can be set to different values which allow either bidirectional or unidirectional current sensing. The possible values of V_{REFNOM} are indicated in Table 2.

The sensitivity is by default non ratiometric to V_{REF} . If ratiometricity is activated the sensitivity becomes as follows:

$$S(V_{REF}) = S(V_{REFNOM}) \cdot \frac{V_{REF}}{V_{REFNOM}}$$

Fully-Differential Output Mode

In fully-differential output mode, both VREF and AOUT are analog outputs to achieve double voltage swing: AOUT is the non-inverting output, while VREF is the inverting output:

$$\begin{aligned} V_{AOUT}(I_{PN}) &= V_{QAOUT} + S \cdot I_{PN} \\ V_{REF}(I_{PN}) &= V_{QREF} - S \cdot I_{PN} \end{aligned}$$

The quiescent voltage is derived from the supply pins VDD and GND and has the same value on both AOUT and VREF:

$$V_{QAOUT}(V_{DD}) = V_{QREF}(V_{DD}) = \frac{V_{DD}}{2}$$

The sensitivity in the fully-differential mode can be generally expressed as:

$$S(V_{DD})_{diff} = S(3.3V)_{diff} \cdot \frac{V_{DD}}{3.3V}$$

In this mode, the quiescent voltages and the sensitivity are both ratiometric with respect to V_{DD} if ratiometricity is enabled.

Semi-Differential Output Mode

In semi-differential output mode, the sensor is using a chip-internal reference voltage to generate the quiescent voltage that is available on pin VREF (used as output).

The analog measurement result is available as single-ended output signal on AOUT. The dependence of sensitivity and output offset on reference voltage is the same as described in single-ended output mode.

The quiescent voltage is programmable at 3 different values, V_{OQbid_1} and V_{OQbid_2} for bidirectional current and V_{OQuni} for unidirectional current (see Table 4).

Total error distribution

Figure 3 shows the total output error at 0h (E_{TOTt}) and over lifetime (E_{TOTL}) over the full scale range for sensitivity range S1 (10mV/A).

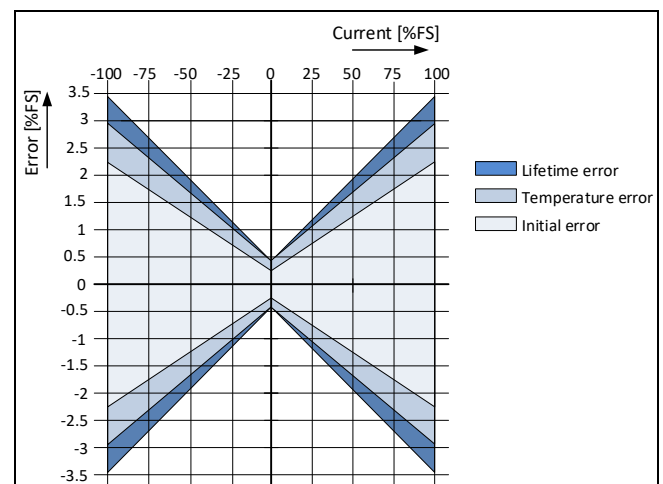

Figure 3 Distribution of max. total error in S1 range

Table 4 Analog Output Characteristics

General conditions (unless otherwise specified): $V_{DD} = 3.3V$; $T_S = -40^{\circ}C \dots +105^{\circ}C$

Parameter	Symbol	Min	Typ	Max	Unit	Note / Test conditions
Quiescent output voltage (bidirectional option 1) ¹⁾²⁾	V_{OQbid_1}	-	$V_{DD}/2$	-	V	$I_{PN} = 0A$; fully-differential or semi-differential (bidirectional) modes, standard setting
Quiescent output voltage (bidirectional option 2) ²⁾	V_{OQbid_2}	-	1.5	-	V	$I_{PN} = 0A$; semi-differential (bidirectional) mode; for this option the ratiometricity offset is disabled
Quiescent output voltage (unidirectional mode) ²⁾	V_{OQuni}	-	$V_{DD}/5.5$	-	V	$I_{PN} = 0A$; semi-differential (unidirectional) mode
Sensitivity, range1 ¹⁾²⁾³⁾	S_1	-	10	-	mV/A	$\pm 120A$ FS (Full Scale)
Sensitivity, range2 ²⁾³⁾	S_2	-	12	-	mV/A	$\pm 100A$ FS
Sensitivity, range3 ²⁾³⁾	S_3	-	16	-	mV/A	$\pm 75A$ FS
Sensitivity, range4 ²⁾³⁾	S_4	-	24	-	mV/A	$\pm 50A$ FS
Sensitivity, range5 ²⁾³⁾	S_5	-	32	-	mV/A	$\pm 37.5A$ FS
Sensitivity, range6 ²⁾³⁾	S_6	-	48	-	mV/A	$\pm 25A$ FS
Sensitivity ratiometry factor	K_S	-	1	-	-	
Quiescent ratiometry factor	K_{OQ}	-	1	-	-	
Analog output drive capability	I_O	-2	-	2	mA	DC current
Analog output saturation voltage	V_{SAT}	-	150	300	mV	$V_{DD} - V_{AOUT}$; Output current = 2mA
Transfer function cutoff frequency	BW	120	240	-	kHz	-3dB criterion, $C_O = 6.8nF$
Output phase delay ⁴⁾	φ_{delay}	-	-	48	°	$f_{signal} = 120kHz$
Output Noise density ⁵⁾⁶⁾	I_{NOISE}	-	350	-	$\mu A/\sqrt{Hz}$	Referenced to Input current, typical value is at 25°C. Higher noise is present at higher temperatures.
External Homogenous magnetic field suppression ⁴⁾	B_{SR}	34	40	-	dB	Frequency up to 150kHz. Up to 20mT homogeneous field applied

1) Pre-configured setting, for other pre-configured versions please contact your local sales.

2) Can be programmed by the user (valid only for 120A version).

3) Values refer to semi-differential mode or single-ended mode, with $V_{REF} = 1.65V$.

In fully-differential mode the sensitivity value is doubled.

4) Not subject to production test. Verified by design and characterization.

5) Typical value in fully-differential mode, sensitivity range S6

6) $Noise\ Density = \frac{Output\ Noise\ [V_{RMS}]}{\sqrt{\frac{\pi}{2} * BW[Hz]}} * \frac{1}{Sensitivity\ [\frac{V}{A}]}$

Table 4 Analog Output Characteristics (cont'd)

General conditions (unless otherwise specified): $V_{DD} = 3.3V$; $T_S = -40^{\circ}C \dots +105^{\circ}C$

Parameter	Symbol	Min	Typ	Max	Unit	Note / Test conditions
Sensitivity error (all ranges)	E_{SENS}	-1.4	-	1.4	%	$T_S = 25^{\circ}C, 0h, \pm 3\sigma$
Sensitivity error (all ranges) over temperature	E_{SENS_T}	-2.1	-	2.1	%	$T_S = -40^{\circ}C \text{ to } 25^{\circ}C, 0h, \pm 3\sigma$
		-1.5	-	1.5	%	$T_S = 25^{\circ}C \text{ to } 105^{\circ}C, 0h, \pm 3\sigma$
Sensitivity error (all ranges) over temperature and lifetime ⁴⁾	E_{SENS_L}	-3	-	3	%	
Output offset (all ranges)	E_{OFF}	-200	-	200	mA	$T_S = 25^{\circ}C, 0h, \pm 3\sigma$
Output offset (all ranges) over temperature	E_{OFF_T}	-200	-	200	mA	$T_S = -40^{\circ}C \text{ to } 25^{\circ}C, 0h, \pm 3\sigma$
		-250	-	250	mA	$T_S = 25^{\circ}C \text{ to } 105^{\circ}C, 0h, \pm 3\sigma$
Output offset (all ranges) over temperature and lifetime ⁴⁾	E_{OFF_L}	-500	-	500	mA	
Total error (S1)	$E_{TOT_{S1}}$	-1.6	-	1.6	%	$T_S = 25^{\circ}C, 0h, \pm 3\sigma$, includes linearity error
Total error (S1) over temperature	$E_{TOT_{S1}}$	-2.3	-	2.3	%	$T_S = -40^{\circ}C \text{ to } 25^{\circ}C, 0h, \pm 3\sigma$, includes linearity error
		-1.7	-	1.7	%	$T_S = 25^{\circ}C \text{ to } 105^{\circ}C, 0h, \pm 3\sigma$, includes linearity error
Total error (S6)	$E_{TOT_{S6}}$	-1.7	-	1.7	%	$T_S = 25^{\circ}C, 0h, \pm 3\sigma$, includes linearity error
Total error (S6) over temperature	$E_{TOT_{S6}}$	-2.3	-	2.3	%	$T_S = -40^{\circ}C \text{ to } 25^{\circ}C, 0h, \pm 3\sigma$, includes linearity error
		-2.0	-	2.0	%	$T_S = 25^{\circ}C \text{ to } 105^{\circ}C, 0h, \pm 3\sigma$, includes linearity error
Total error over temperature and lifetime ⁴⁾	E_{TOTL}	-3.45	-	3.45	%	Percentage of FS, sensitivity S1; includes sensitivity, offset and linearity error

4) Not subject to production test. Verified by design and characterization.

Fast Over-Current Detection (OCD)

The Over-Current Detection (OCD) function allows fast detection of over-current events. The raw analog output of the Hall probes is fed directly into comparators with programmable switching thresholds. A user programmable deglitch filter is implemented to enable the suppression of fast switching transients. The two different open-drain OCD pins are active low and can be directly combined into a wired-AND configuration on board level to have a general over-current detection signal. TLI4971 supports two independent programmable OCD outputs, suited for different application needs.

The OCD pins are providing a very fast response, thanks to independence from the main signal path. They can be used as a trap functionality to quickly shut down the current source as well as for precise detection of soft overload conditions.

OCD pins external connection

The OCD pins can be connected to a logic input pin of the microcontroller and/or the gate-driver to quickly react to over-current events. They are designed as open-drain outputs to easily setup a wired-AND configuration and allow monitoring of several current sensors outputs via only one microcontroller pin.

OCD thresholds

The symmetric threshold level of the OCD outputs is adjustable and triggers an over-current event in case of a positive or negative over-current. The possible threshold levels are listed in Table 6 and Table 7. The instruction for the settings is documented in the TLI4971 programming guide.

OCD outputs timing behavior

Both output pins feature a deglitch filter to avoid false triggers by noise spikes on the current rail. Deglitch filter settings can be programmed according to application needs. Available options are listed in Table 6 and Table 7.

Figure 4 shows the OCD output pin typical behavior during an over-current event.

Over-current Pulse 1: duration exceeds the over-current response time t_{D_OCDx} + response time jitter Δt_{D_OCDx} + deglitch filter time $t_{deglitch}$. The OCD output voltage is set low until the current value drops below the OCD threshold.

Over-current Pulse 2: duration does not exceed the over-current response time t_{D_OCDx} and therefore no OCD event is generated.

Over-current Pulse 3: duration exceeds the response time t_{D_OCDx} + response time jitter Δt_{D_OCDx} , but does not exceed the glitch filter time $t_{deglitch}$ and no OCD event is generated.

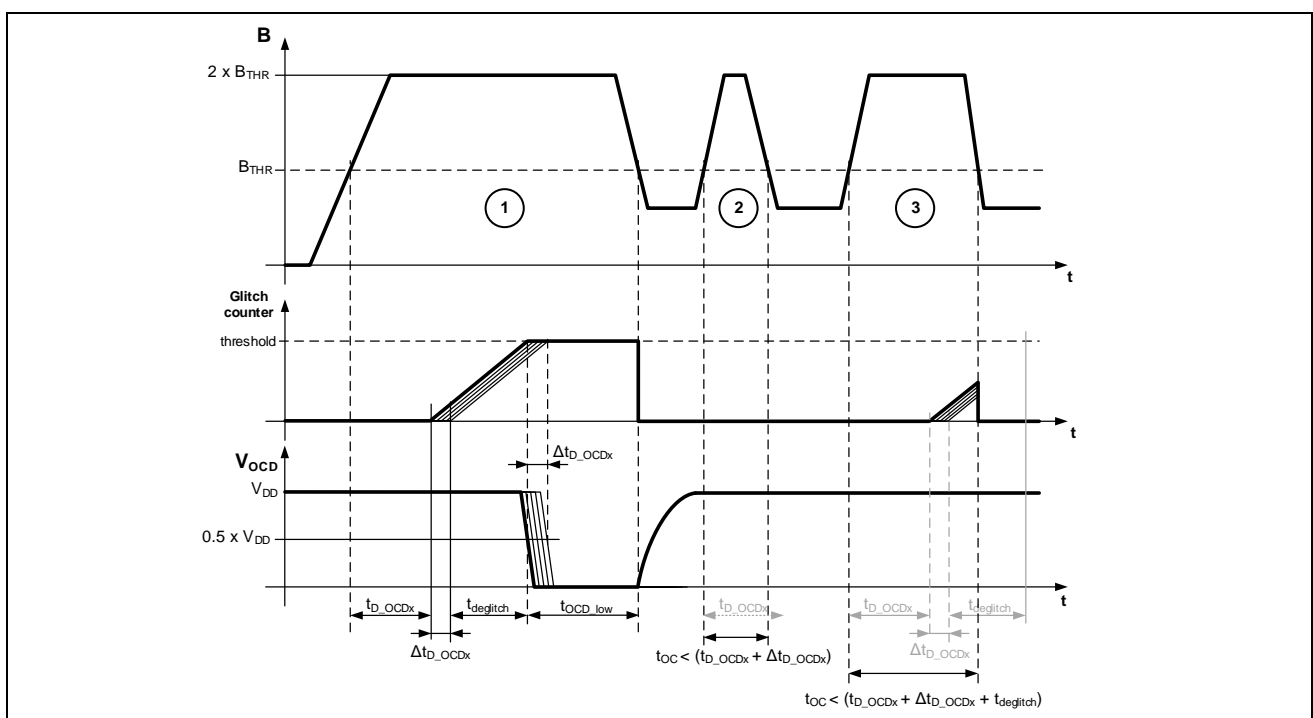

Figure 4 Fast over-current detection output timing

Fast Over-Current Detection (OCD) Output Parameters

Table 5 Common OCD Parameters

General conditions (unless otherwise specified): $V_{DD} = 3.3V$; $T_S = -40^{\circ}C \dots +105^{\circ}C$, $C_L = 1nF$, $R_{PU} = 4.7k\Omega$

Parameter	Symbol	Min	Typ	Max	Unit	Note / Test Conditions
Threshold level tolerance ¹⁾	I_{THT}	-10	-	10	%	
Response time jitter ¹⁾	Δt_{D_OCD}	-	-	0.25	μs	At 3σ , $I_{rail} = 2 \times I_{THR,x}$, input rise time $0.1\mu s$
Deglintch filter basic time	t_{OCDgl}	400	500	600	ns	
Detection minimum time	t_{OCD_low}	3	-	-	μs	Valid for both OCDs
Load capacitance	C_L	-	-	1	nF	
Open-drain current	I_{OD_ON}	-	-	1	mA	DC current
Pull-up resistor	R_{PU}	1	4.7	10	k Ω	To V_{DD}

1) Not subject to production test. Verified by design and characterization.

Table 6 OCD1 Parameters

Parameter	Symbol	Min	Typ	Max	Unit	Note / Test Conditions
Threshold level - Level1 ¹⁾²⁾³⁾	$I_{THR1.1}$	-	1.25	-	$\times I_{FSR}$	Factor with respect to I_{FS} (I_{FS} = current full scale according to programming i.e. 120A)
Threshold level - Level2 ¹⁾²⁾	$I_{THR1.2}$	-	1.39	-	$\times I_{FSR}$	Factor with respect to I_{FS}
Threshold level - Level3 ¹⁾²⁾	$I_{THR1.3}$	-	1.54	-	$\times I_{FSR}$	Factor with respect to I_{FS}
Threshold level - Level4 ¹⁾²⁾	$I_{THR1.4}$	-	1.68	-	$\times I_{FSR}$	Factor with respect to I_{FS}
Threshold level - Level5 ¹⁾²⁾	$I_{THR1.5}$	-	1.82	-	$\times I_{FSR}$	Factor with respect to I_{FS}
Threshold level - Level6 ¹⁾²⁾	$I_{THR1.6}$	-	1.96	-	$\times I_{FSR}$	Factor with respect to I_{FS}
Threshold level - Level7 ¹⁾²⁾	$I_{THR1.7}$	-	2.11	-	$\times I_{FSR}$	Factor with respect to I_{FS}
Threshold level - Level8 ¹⁾²⁾	$I_{THR1.8}$	-	2.25	-	$\times I_{FSR}$	Factor with respect to I_{FS}
Response time ⁴⁾	t_{D_OCD1}	-	0.7	1	μs	$I_{PN} = 2 \times I_{THR1,x}$
Fall time ⁵⁾	t_{f_OCD1}	-	100	150	ns	
Deglintch filter setting ²⁾⁶⁾	$OCD1_{gl_mul}$	0	-	7	-	$t_{deglitch} = OCD1_{gl_mul} \times t_{OCDgl}$ pre-configured setting = 0

1) Symmetric threshold level for positive and negative currents.

2) Can be programmed by user.

3) Pre-configured threshold level

4) Time between primary current exceeding current threshold and falling edge of OCD1-pin at 50%.

5) Not subject to production test. Verified by design and characterization.

6) The specified deglitching timing is valid when input current step overtakes the threshold of at least 10%.

Table 7 OCD2 Parameters

Parameter	Symbol	Min	Typ	Max	Unit	Note / Test Conditions
Threshold level - level1 ¹⁾²⁾	$I_{THR2.1}$	-	0.5	-	$\times I_{FSR}$	Factor with respect to I_{FS} (I_{FS} = current full scale according to programming i.e. 120A)
Threshold level - level2 ¹⁾²⁾	$I_{THR2.2}$	-	0.61	-	$\times I_{FSR}$	Factor with respect to I_{FS}
Threshold level - level3 ¹⁾²⁾	$I_{THR2.3}$	-	0.71	-	$\times I_{FSR}$	Factor with respect to I_{FS}
Threshold level - level4 ¹⁾²⁾³⁾	$I_{THR2.4}$	-	0.82	-	$\times I_{FSR}$	Factor with respect to I_{FS}
Threshold level - level5 ¹⁾²⁾	$I_{THR2.5}$	-	0.93	-	$\times I_{FSR}$	Factor with respect to I_{FS}
Threshold level - level6 ¹⁾²⁾	$I_{THR2.6}$	-	1.04	-	$\times I_{FSR}$	Factor with respect to I_{FS}
Threshold level - level7 ¹⁾²⁾	$I_{THR2.7}$	-	1.14	-	$\times I_{FSR}$	Factor with respect to I_{FS}
Threshold level - level8 ¹⁾²⁾	$I_{THR2.8}$	-	1.25	-	$\times I_{FSR}$	Factor with respect to I_{FS}
Response time ⁴⁾	t_{D_OCD2}	-	0.7	1.2	μs	$I_{PN} = 2 \times I_{THR2.x}$
Fall time ⁵⁾	t_{f_OCD2}	-	200	300	ns	
Deglintch filter setting ²⁾⁶⁾	$OCD2_{gl_mul}$	0	-	15	-	$t_{degitch} = OCD2_{gl_mul} \times t_{OCDgl}$ pre-configured setting = 0

1) Symmetric threshold level for positive and negative currents.

2) Can be programmed by user.

3) Pre-configured threshold level.

4) Time between primary current exceeding current threshold and falling edge of OCD2-pin at 50%.

5) Not subject to production test. Verified by design and characterization.

6) The specified deglitching timing is valid when input current step overtakes the threshold of at least 10%.

Undervoltage / Overvoltage detection

TLI4971 is able to detect undervoltage or overvoltage condition of its own power supply (V_{DD}). When an undervoltage ($V_{DD} < U_{VLOH}$) or overvoltage ($V_{DD} > O_{VLOH}$) condition is detected both OCD pins are pulled down in order to signal such a condition to the user.

The undervoltage detection on OCD pins is performed only if $V_{DD} > V_{DD, OCD}$.

Both OCD pins are pulled down at start up. When V_{DD} exceeds the undervoltage threshold U_{VLOH_R} and the power on delay time t_{POR} has been reached, the sensor indicates the correct functionality and high accuracy by releasing the OCD pins.

Table 8 Undervoltage / Overvoltage parameters

General conditions (unless otherwise specified): $V_{DD} = 3.3V$; $T_S = -40^\circ C \dots +105^\circ C$

Parameter	Symbol	Min.	Typ.	Max.	Unit	Note / Test Condition
Supply undervoltage lockout threshold	U_{VLOH_R}	-	-	3	V	V_{DD} at rising edge
Supply undervoltage lockout threshold	U_{VLOH_F}	2.5	-	-	V	V_{DD} at falling edge
Supply overvoltage lockout threshold	O_{VLOH}	3.55	-	-	V	V_{DD} at rising edge
OCD undervoltage detection limit	$V_{DD, OCD}$	1.8	-	-	V	For $V_{DD} < V_{DD, OCD}$ undervoltage may not be performed.

Isolation Characteristics

TLI4971 conforms functional isolation.

Table 9 Isolation Characteristics

Parameter	Symbol	Min	Typ	Max	Unit	Note / Test Conditions
Maximum rated working voltage (sine wave) ¹⁾²⁾³⁾	V_{IOWM}	-	-	690	V	RMS, @ 4000m altitude
Maximum rated working voltage (sine wave) ¹⁾²⁾³⁾	V_{IOWMP}	-	-	975	V	Peak, @ 4000m altitude
Maximum repetitive isolation voltage ²⁾³⁾	V_{IORM}	-	-	1150	V	Max DC voltage, spike, @ 4000m altitude
Apparent charge voltage capability (method B) ²⁾³⁾	V_{PDtest}	1500	-	-	V	Partial discharge < 5pC peak @ 0m altitude
Isolation test voltage ³⁾⁴⁾	V_{ISO}	3500	-	-	V	RMS, 60s
Isolation production test voltage	V_{ISOP}	3000	-	-	V	RMS, in production, 1.2s, UL certified version
	V_{ISOP}	2470	-	-	V	RMS, in production, 600ms, Non-UL certified version
Isolation pulse test voltage ³⁾	V_{pulse}	6500	-	-	V	Peak, rise time = 1.2 μ s, fall time = 50 μ s
Minimum external creepage distance	CPG	4	-	-	mm	
Minimum external clearance distance	CLR	4	-	-	mm	
Minimum comparative tracking index	CTI	Material group II	-	-	-	
Isolation resistance ³⁾	R_{IO}	10	-	-	G Ω	$U_{IO} = 500V$ DC, 1min

1) The given value is considered an example based on pollution degree 2.

2) After stress test according to qualification plan.

3) Not subject to production test. Verified by design and characterization.

4) Agency type tested for 60 seconds by UL according to UL 1577 standard.

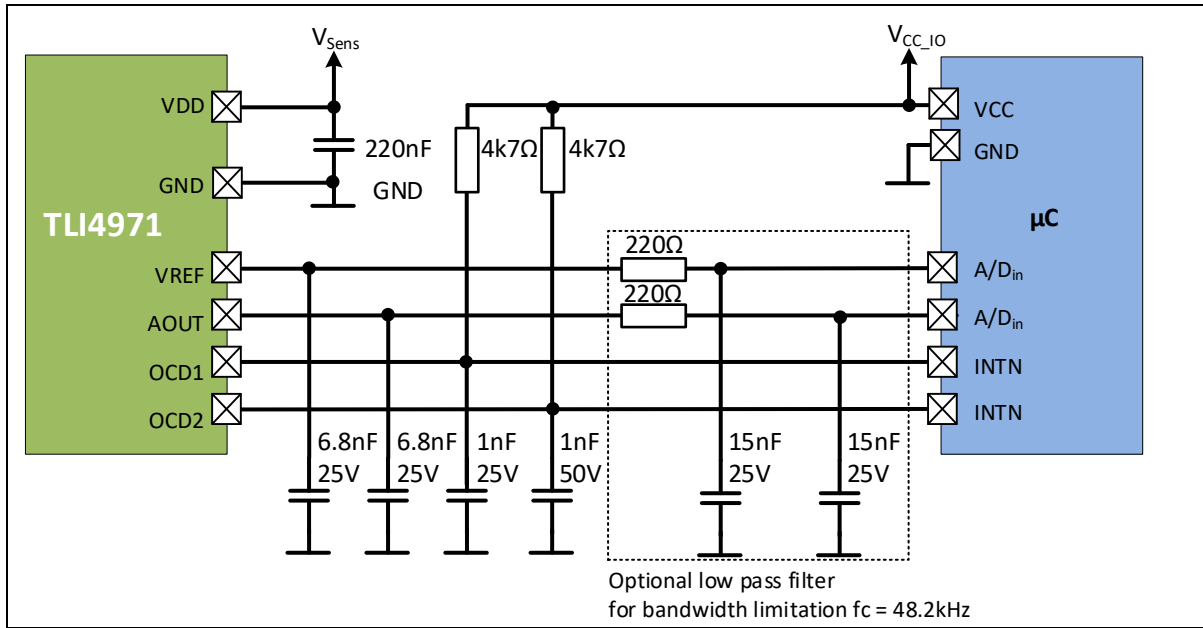

Figure 7 Application circuit with external components. In-circuit-programming not included.

For bandwidth limitation an external filter is recommended as shown in the above application circuits.

Typical Performance Characteristics

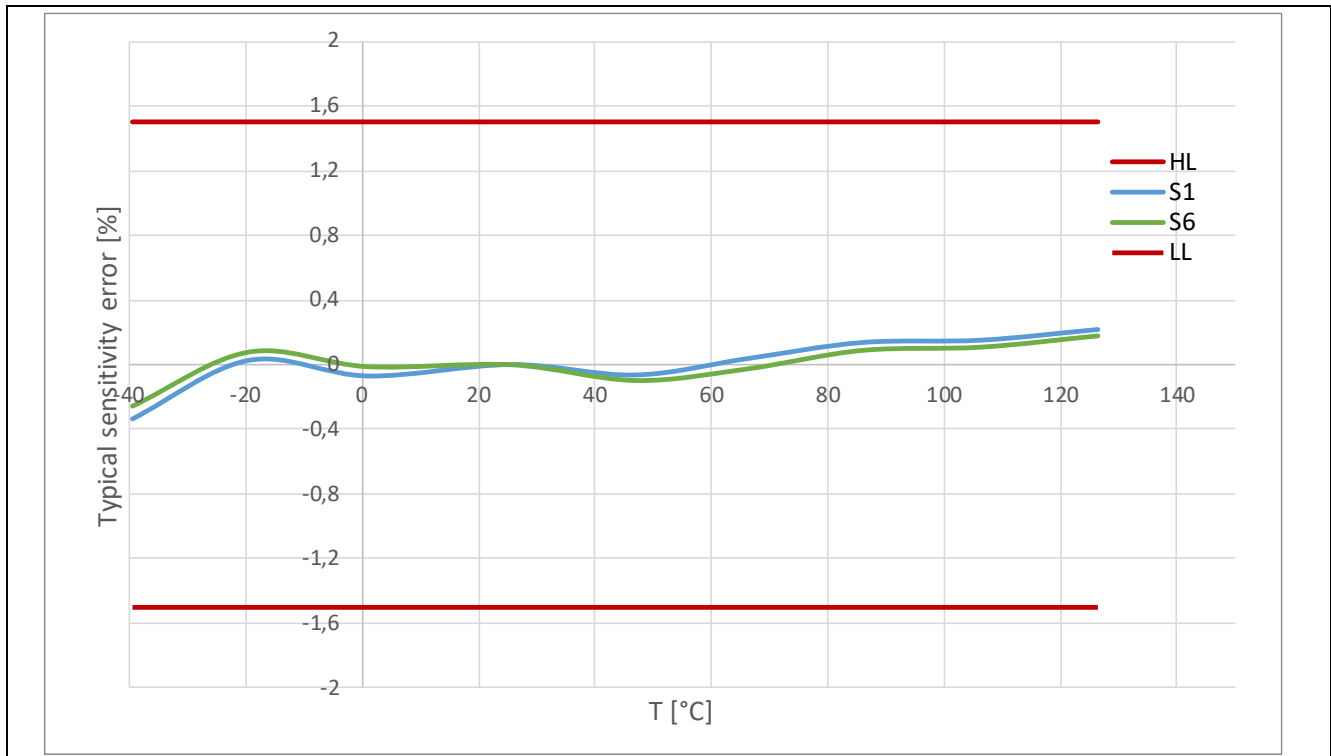

Figure 8 Typical error in sensitivity over temperature

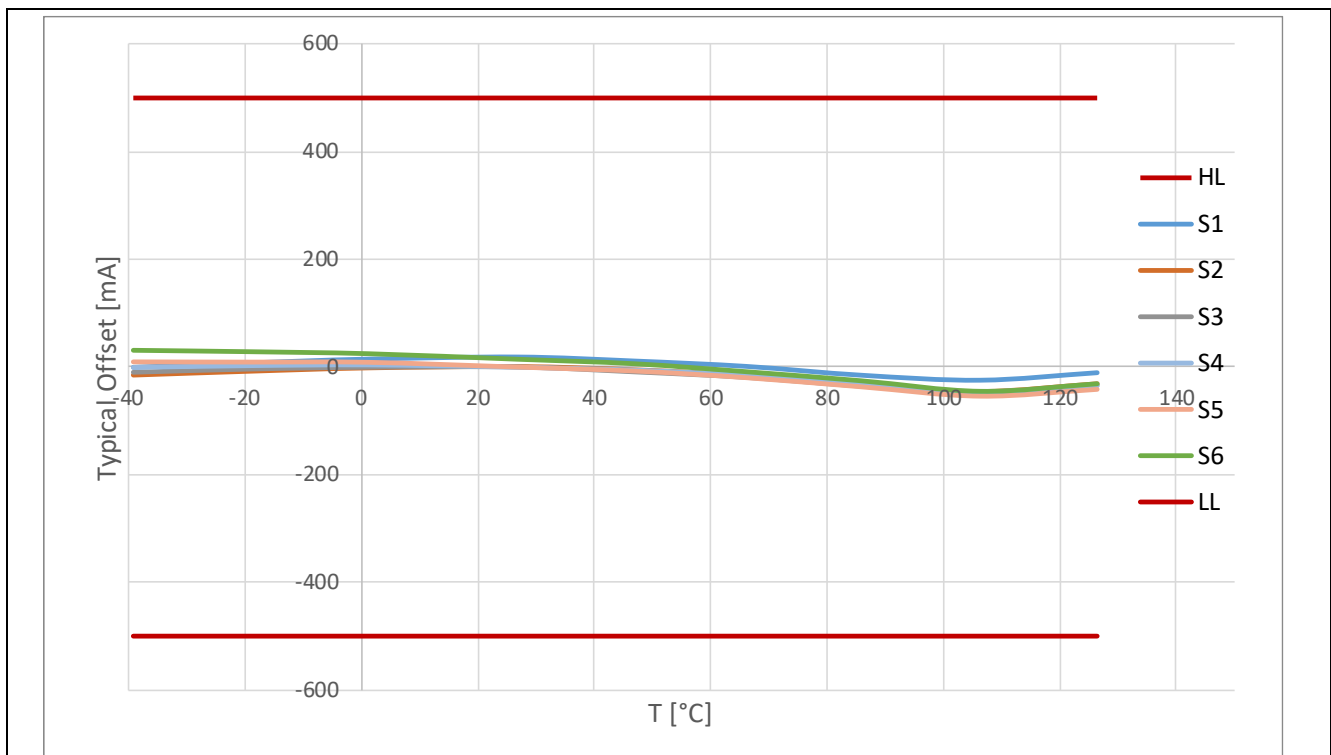

Figure 9 Typical offset drift over temperature

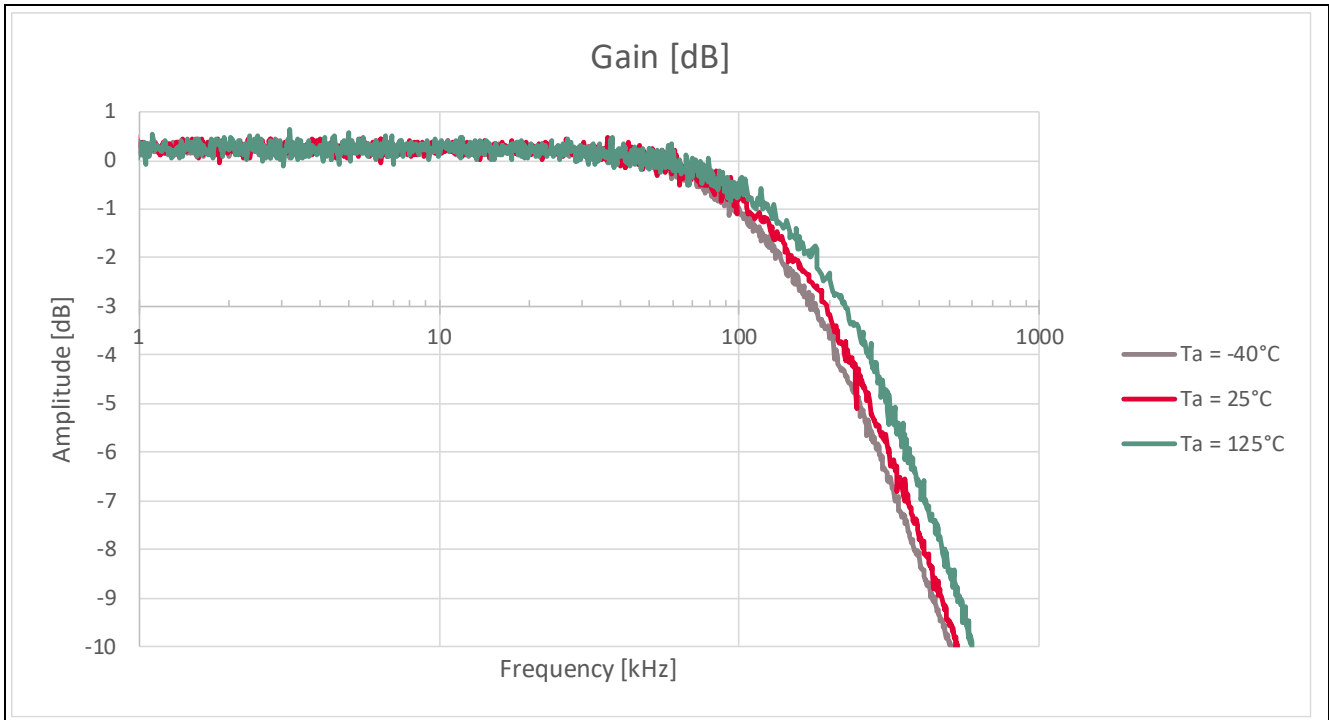

Figure 10 Typical amplitude over frequency

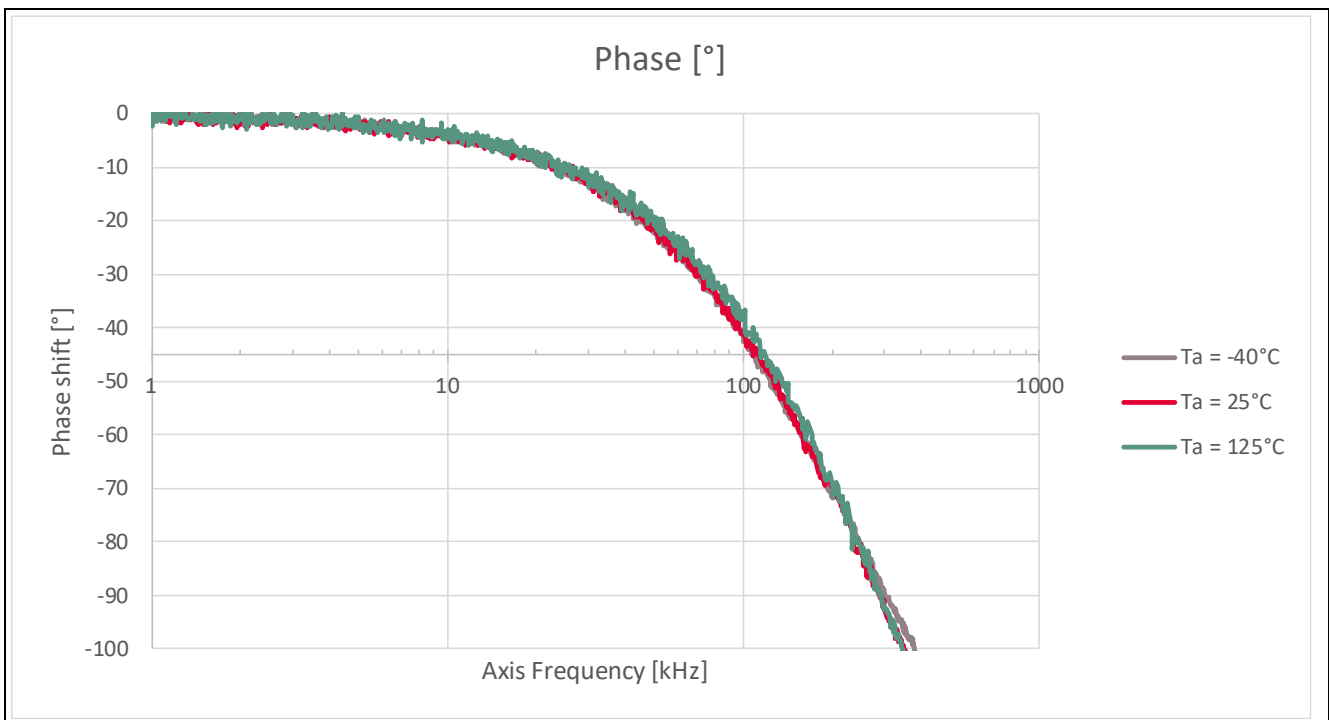

Figure 11 Typical phase-shift over frequency

Revision History

Major changes since the last revision

Date	Description of change
10-02-2020	Datasheet version 1.10
12-02-2021	Editorial changes first page: shorten features, benefits and description
	Add 6 new variants to order information
	Pre-configured OCD threshold levels changed: Page3, Table 6 and Table 7
	Updated Table 9, isolation characteristics
	Updated application circuits
	Increase upper limit of EEPROM programming voltage from 20.7 to 21.0
	Added chapter "typical performance characteristics"
	Datasheet version 1.20
01-12-2021	Updated Table 3: Added typical value for the Power-on delay time
	Updated Table 4: Reprogramming limited to 120A – version only
	Updated Table 4: Added accuracy criterion 3σ to initial sensitivity, offset and total error
	Updated Table 5: Enlarged the allowed range of pull-up resistor
	Separated Table 8 which was former part of Table 3: Overvoltage / Undervoltage parameters
	Updated Figure 8 and Figure 9: latest production data
	Adding Figure 10 and Figure 11: gain, phase-shift over frequency
	Datasheet version 1.30