

TM18 Series Sensors

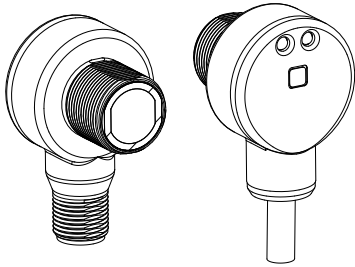

Datasheet



- Heavy duty metal housing with 18 mm threaded barrel mount and integral metal QD prevents sensor damage during machine assembly, transport, maintenance, and operation
- Right angle "T" mounting fits in tight places, prevents sensor damage, and avoids personnel catch points
- Models with dedicated 3-wire output NPN or PNP for OEM machine builders — designed to work with I/O block splitters for reduced wiring costs
- Models with 4-wire complementary NPN or PNP outputs available
- Featuring EZ-BEAM technology provides reliable sensing without adjustments
- Visible red LED models available in opposed, polarized retroreflective, diffuse, and fixed-field (background suppression) modes
- Infrared models available in fixed-field (background suppression) mode
- Completely epoxy encapsulated electronics to provide superior durability, especially in harsh sensing environments
- Sensors rated IP69K for resistance to intermittent high pressure washdown
- Innovative dual indicator systems takes the guess work out of sensor performance monitoring
- Enhanced immunity to fluorescent lights on fixed field and diffuse sensors
- Cross talk avoidance allows two sensors to be used in close proximity on polarized retro, diffuse, and fixed field sensors

To order the 9 m (30 ft) cable models, add the suffix "W/30" to the cabled model number. For example, "TM186E W/30". To order the 4-pin Euro M12 integral QD models, add suffix Q8 (for example, TM186EQ8). To order the 4-pin Euro M12 pigtail QD models: add suffix Q5 (for example, TM186EQ5).

Opposed Mode Sensors				
Model Number	Mode	Range	LED	Output
TM186E		20 m	Visible red 625 nm	None
TM18AP6R			None	PNP, LO 3-wire
TM18RP6R				PNP, DO 3-wire
TM18VP6R				PNP, LO/DO 4-wire
TM18AN6R				NPN, LO 3-wire
TM18RN6R				NPN, DO 3-wire
TM18VN6R				NPN, LO/DO 4-wire

Polarized Retroreflective				
Model Number	Mode	Range	LED	Output
TM18AP6LP		5.5 m ¹	Visible red 624 nm	PNP, LO 3-wire
TM18RP6LP				PNP, DO 3-wire
TM18VP6LP				PNP, LO/DO 4-wire
TM18AN6LP				NPN, LO 3-wire
TM18RN6LP				NPN, DO 3-wire
TM18VN6LP				NPN, LO/DO 4-wire

¹ Range specified with BRT-84 reflector.

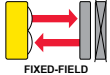
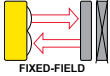

Fixed-Field Background Suppression				
Model Number	Mode	Range	LED	Output
TM18AP6FF25		25 mm	Visible red 660 nm	PNP, LO 3-wire
TM18VP6FF25				PNP, LO/DO 4-wire
TM18AN6FF25				NPN, LO 3-wire
TM18VN6FF25				NPN, LO/DO 4-wire
TM18AP6FF50		50 mm		PNP, LO 3-wire
TM18VP6FF50				PNP, LO/DO 4-wire
TM18AN6FF50				NPN, LO 3-wire
TM18VN6FF50				NPN, LO/DO 4-wire
TM18AP6FF100		100 mm		PNP, LO 3-wire
TM18VP6FF100				PNP, LO/DO 4-wire
TM18AN6FF100				NPN, LO 3-wire
TM18VN6FF100				NPN, LO/DO 4-wire
TM18AP6FF25IR		25 mm	Infrared, 880 nm	PNP, LO 3-wire
TM18VP6FF25IR				PNP, LO/DO 4-wire
TM18AN6FF25IR				NPN, LO 3-wire
TM18VN6FF25IR				NPN, LO/DO 4-wire
TM18AP6FF50IR		50 mm		PNP, LO 3-wire
TM18VP6FF50IR				PNP, LO/DO 4-wire
TM18AN6FF50IR				NPN, LO 3-wire
TM18VN6FF50IR				NPN, LO/DO 4-wire
TM18AP6FF100IR		100 mm		PNP, LO 3-wire
TM18VP6FF100IR				PNP, LO/DO 4-wire
TM18AN6FF100IR				NPN, LO 3-wire
TM18VN6FF100IR				NPN, LO/DO 4-wire

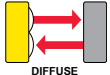
Diffuse Visible Mode				
Model Number	Mode	Range	LED	Output
TM18AP6DV		500 mm	Visible red 660 nm	PNP, LO 3-wire
TM18RP6DV				PNP, DO 3-wire
TM18VP6DV				PNP, LO/DO 4-wire
TM18AN6DV				NPN, LO 3-wire
TM18RN6DV				NPN, DO 3-wire
TM18VN6DV				NPN, LO/DO 4-wire



WARNING: Not To Be Used for Personnel Protection

Never use this device as a sensing device for personnel protection. Doing so could lead to serious injury or death. This device does not include the self-checking redundant circuitry necessary to allow its use in personnel safety applications. A sensor failure or malfunction can cause either an energized or de-energized sensor output condition.

Specifications

Supply Voltage and Current - Class 2

10 to 30 V dc (10% max. ripple within specified limits); supply current (exclusive of load current):
 Emitters: 25 mA
 Receivers: 20 mA
 Polarized Retroreflective: 20 mA
 Diffuse and Fixed-Field: 35 mA

Supply Protection Circuitry

Protected against reverse polarity and transient voltages

Effective Beam

13 mm for opposed mode sensors

Output Configuration

NPN (current sinking) or PNP (current sourcing), depending on model
 Light Operate: Output conducts when sensor receives its own (or the emitter's) modulated light
 Dark Operate: Output conducts when sensor does not receive its own (or the emitter's) modulated light

Connections

2 m (6.5 ft) or 9 m (30 ft) PVC attached cable
 Integral 4-pin M12/Euro-style quick disconnect
 4-pin M12/Euro-style PVC pigtail quick disconnect

Construction

Housing: Zinc die cast with nickel plating
 Lens: PMMA or PC (opposed mode only)
 Black Cover: PBT polyester housing

Output Protection Circuitry

Protected against false pulse on power-up and continuous overload or short circuit of outputs

Output Rating

150 mA maximum each output at 25 °C, derated to 100 mA at 70 °C (derate about 1 mA per °C)
 OFF-state leakage current: < 1 microamp at 30 V dc
 ON-state saturation voltage: < 1 V at 10 mA dc; < 1.5 V at 150 mA dc

Environmental Rating

IEC IP67; quick disconnect models are IEC IP69K when mated with a washdown rated (IEC IP69K) cordset

Operating Conditions

-40 °C to +70 °C (-40 °F to +158 °F)
 90% at +50 °C maximum relative humidity (non-condensing)

Vibration and Mechanical Shock

All models meet Mil. Std. 202F requirements. Method 201A (Vibration; frequency 10 to 60 Hz, max., double amplitude 0.06 in acceleration 10G). Method 213B conditions H&I (Shock: 75G with unit operating; 100G for non-operation)

Adjustments

Diffuse models only: single turn rear panel sensitivity control

Indicators

Two LEDs (green and amber)

Complementary (4-Wire) Models	
Indicator	Description
Green ON	Power ON
Green Flashing*	Output is overloaded
Amber ON	N.O. Output is conducting
Amber Flashing*	Marginal excess gain (1 to 1.5x)

* Not valid for Diffuse or Fixed Field Models.

Single Output (3-Wire) Models	
Indicator	Description
Green ON	Power ON
Green Flashing	N.A.
Amber ON	Output is conducting
Amber Flashing	N.A.

Output Response Time (TM18)

Opposed mode: 1.5 ms ON, 0.75 ms OFF
 Retro: 3 ms ON and OFF
 Diffuse and Fixed Field: 3 ms ON, 1.5 ms OFF
 Note: 100 ms delay on power-up; outputs do not conduct during this time.

Repeatability (TM18)

Opposed mode: 190 µs
 Retro: 585 µs
 Diffuse and Fixed Field: 185 µs

Certifications



Class 2 supply Required;



Required Overcurrent Protection



WARNING: Electrical connections must be made by qualified personnel in accordance with local and national electrical codes and regulations.

Overcurrent protection is required to be provided by end product application per the supplied table.

Overcurrent protection may be provided with external fusing or via Current Limiting, Class 2 Power Supply.

Supply wiring leads < 24 AWG shall not be spliced.

For additional product support, go to <http://www.bannerengineering.com>.

Supply Wiring (AWG)	Required Overcurrent Protection (Amps)
20	5.0
22	3.0
24	2.0
26	1.0
28	0.8
30	0.5

Performance Curves

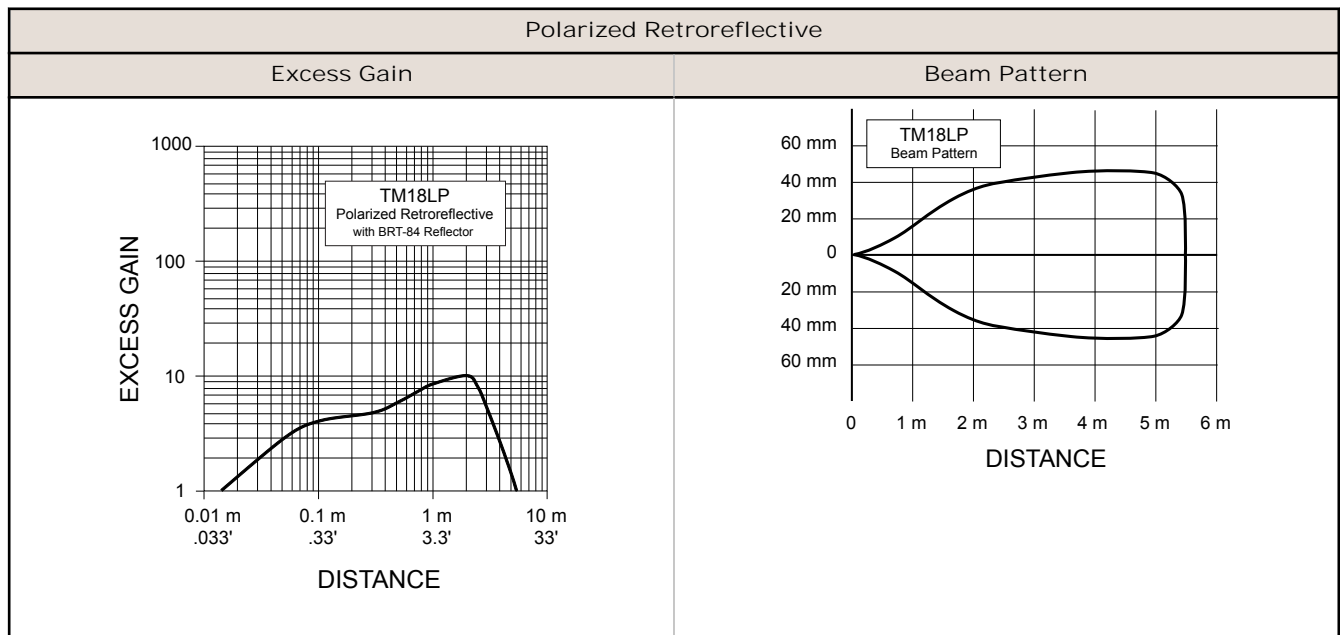
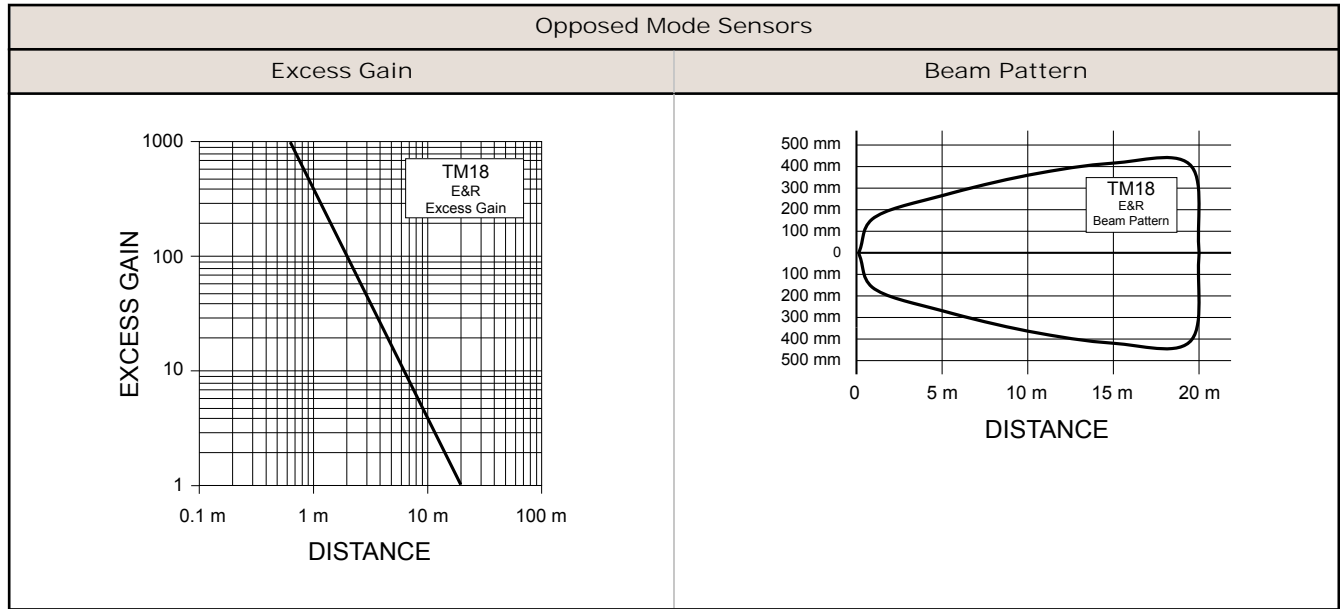

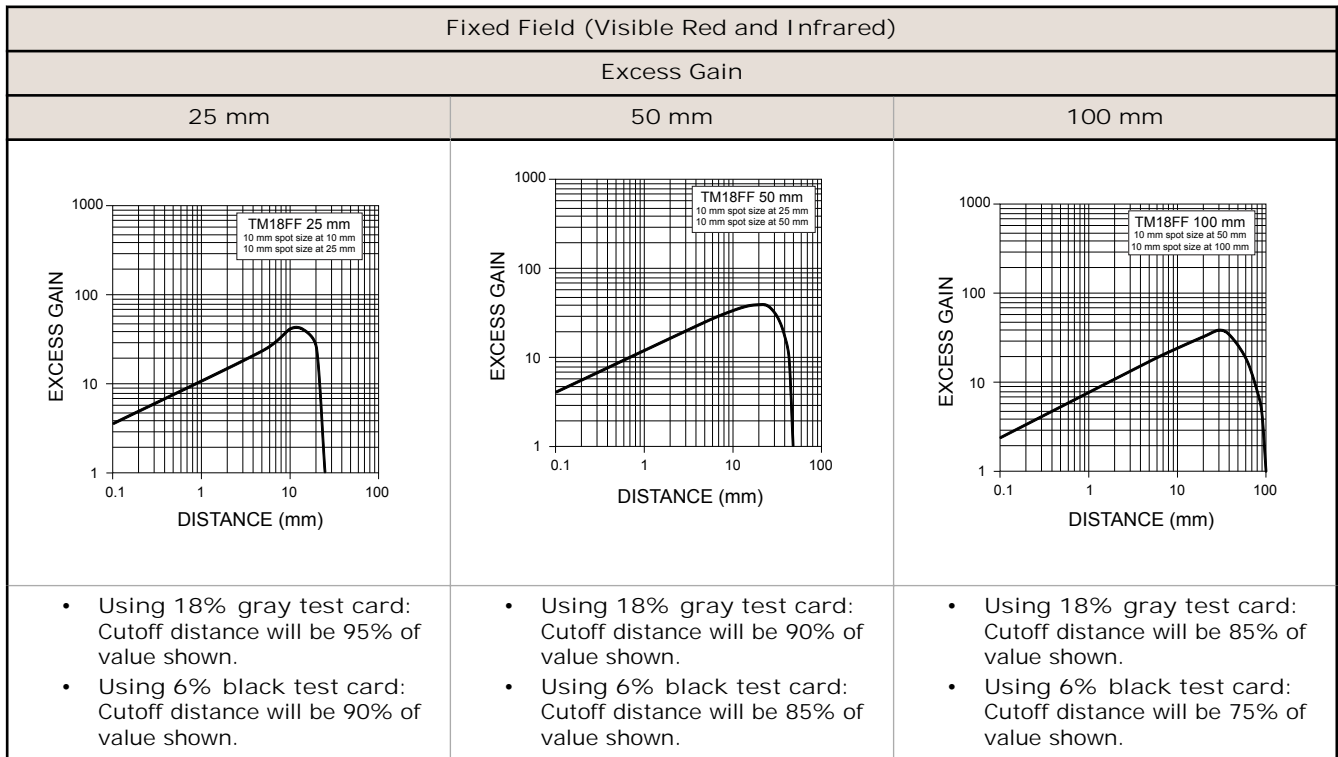
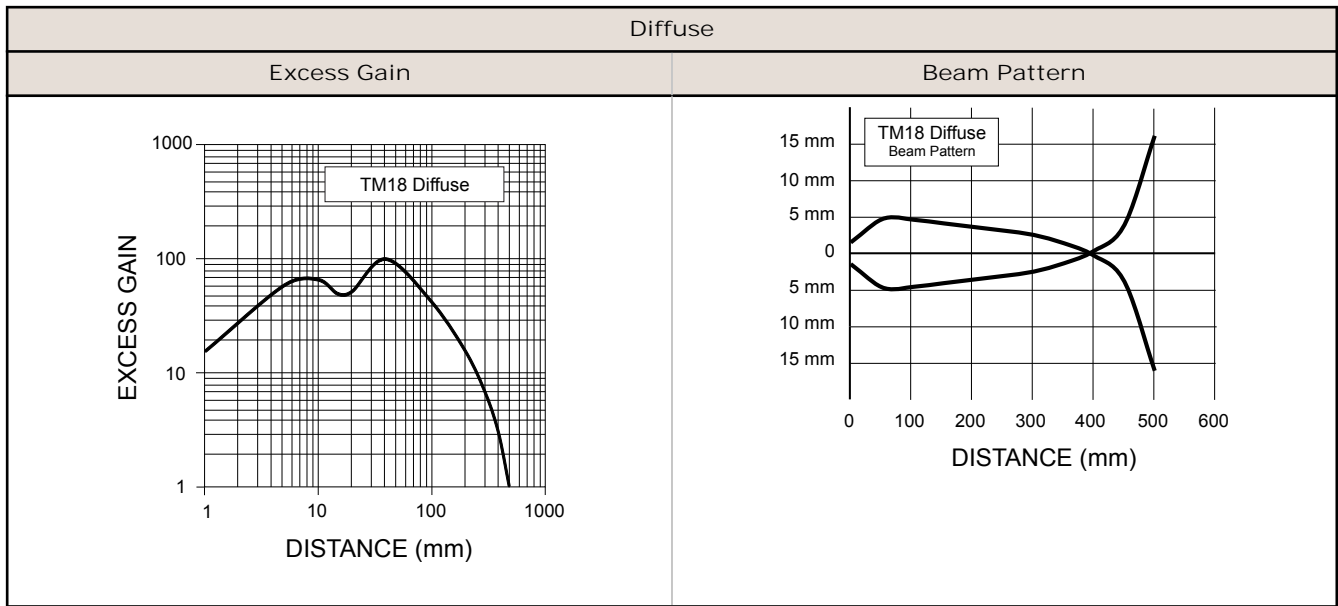

Dimensions

TM18 LP Cable

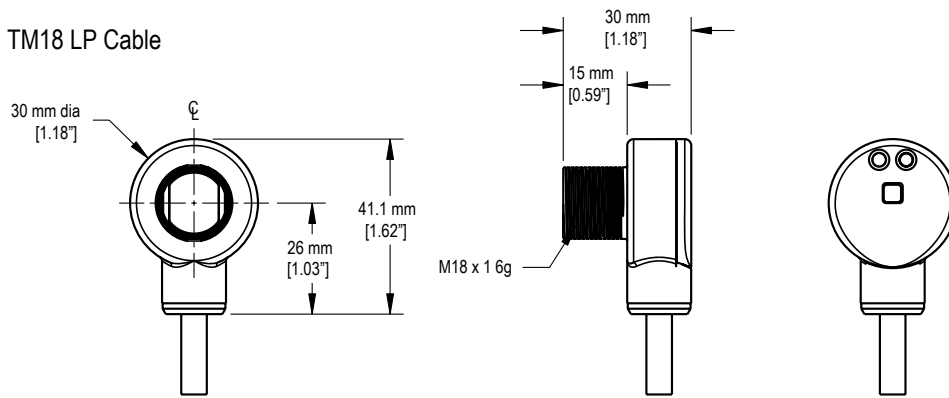

TM18 LP QD

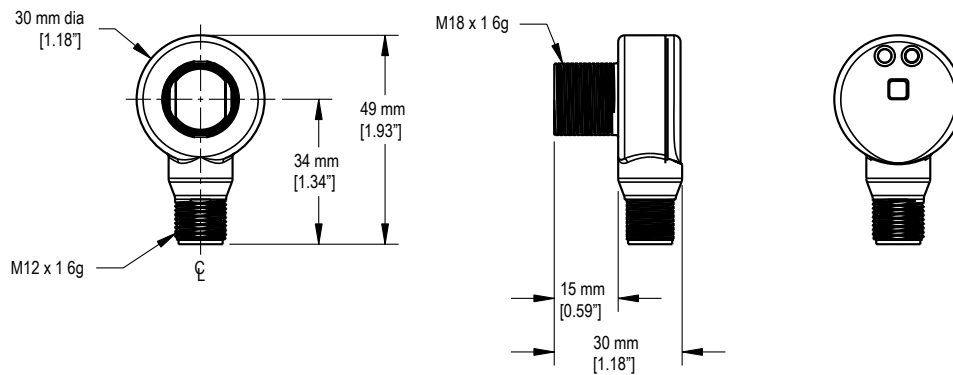

Maximum Torque specification: 5.6 nm or 50 in-lbs. Lockwasher and M18 nut included.

Wiring

Emitter

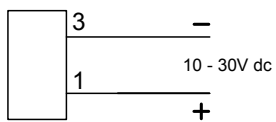

NPN L.O. 3-Wire

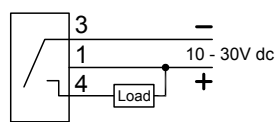

PNP L.O. 3-Wire

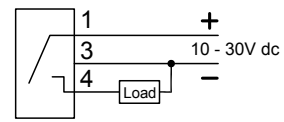

Wiring Key

- 1 = Brown
- 2 = White
- 3 = Blue
- 4 = Black

NPN D.O. 3-Wire

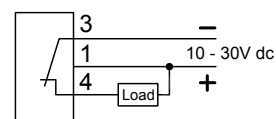

PNP D.O. 3-Wire

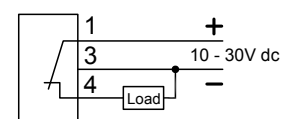

QD and cabled emitter wiring functionality is identical; black and white wires have no connection when not shown.

NPN L.O./D.O. 4-Wire

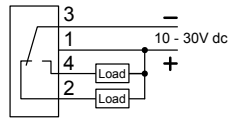

PNP L.O./D.O. 4-Wire

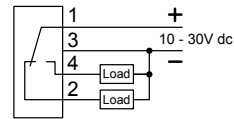

Accessories

Cordsets

4-Pin Threaded M12/Euro-Style Cordsets				
Model	Length	Style	Dimensions	Pinout (Female)
MQDC-406	1.83 m (6 ft)	Straight		<p>1 = Brown 2 = White 3 = Blue 4 = Black</p>
MQDC-415	4.57 m (15 ft)			
MQDC-430	9.14 m (30 ft)			
MQDC-450	15.2 m (50 ft)			
MQDC-406RA	1.83 m (6 ft)	Right-Angle		
MQDC-415RA	4.57 m (15 ft)			
MQDC-430RA	9.14 m (30 ft)			
MQDC-450RA	15.2 m (50 ft)			

Apertures

AP18SCN

Kit includes round apertures of 0.5 mm (0.02 in), 1.0 mm (0.04 in), and 2.5 mm (0.10 in) diameter.

Used with T18, TM18 models.



AP18SRN

Kit includes rectangular apertures of 0.5 mm (0.02 in), 1.0 mm (0.04 in), and 2.5 mm (0.10 in) wide. Each kit also includes a thread-on housing, Teflon® FEP® lens, and o-ring.

Used with T18, TM18



APG18S

Kit with glass lens to protect plastic sensor lens from chemical environments and weld splatter damage.

Used with S18, M18, T18, TM18, and Q4X

