



Main

Range of Product	Modicon TM5
Product or Component Type	Common distribution module
Product Specific Application	Cabling various voltage to power 12 I/O in 24 V DC

Complementary

Range Compatibility	Modicon LMC058 Modicon M258
Product Compatibility	Motion controller Logic controller
[Us] rated supply voltage	24 V
Network type	DC
Short-circuit protection	6.3 A internal fuse
Marking	CE
Net Weight	0.06 lb(US) (0.025 kg)

Environment

Standards	UL 508 CSA C22.2 No 213 IEC 61131-2 CSA C22.2 No 142
Product Certifications	C-tick GOST-R CULus CSA
Ambient air temperature for operation	32...122 °F (0...50 °C) vertical installation) 32...131 °F (0...55 °C) without derating horizontal installation) 32...140 °F (0...60 °C) with derating factor horizontal installation)
Ambient Air Temperature for Storage	-13...158 °F (-25...70 °C)
Relative humidity	5...95 % without condensation
IP degree of protection	IP20IEC 61131-2
Pollution degree	2 IEC 60664
Operating altitude	0...6561.68 ft (0...2000 m)
Storage altitude	0.00...9842.52 ft (0...3000 m)
Vibration resistance	1 gn 8.4...150 Hz DIN rail 3.5 mm 5...8.4 Hz DIN rail
Shock resistance	15 gn 11 ms
Resistance to electrostatic discharge	4 kV on contact EN/IEC 61000-4-2 8 kV in air EN/IEC 61000-4-2
Resistance to electromagnetic fields	0.91 V/m (1 V/m) 2...2.7 GHz EN/IEC 61000-4-3 9.14 V/m (10 V/m) 80...2000 MHz EN/IEC 61000-4-3
Resistance to fast transients	1 kV EN/IEC 61000-4-4 I/O) 1 kV EN/IEC 61000-4-4 shielded cable) 2 kV EN/IEC 61000-4-4 power lines)

Surge withstand	0.5 KV differential mode EN/IEC 61000-4-5 1 kV common mode EN/IEC 61000-4-5
Electromagnetic compatibility	EN/IEC 61000-4-6
Disturbance radiated/conducted	CISPR 11

Ordering and shipping details

Category	22532-M258 PLC
Discount Schedule	PC12
GTIN	3595864074962
Returnability	No
Country of origin	AT

Packing Units

Unit Type of Package 1	PCE
Number of Units in Package 1	1
Package 1 Height	0.79 in (2.000 cm)
Package 1 Width	2.36 in (6.000 cm)
Package 1 Length	4.13 in (10.500 cm)
Package 1 Weight	1.38 oz (39.000 g)
Unit Type of Package 2	S02
Number of Units in Package 2	97
Package 2 Height	5.91 in (15.000 cm)
Package 2 Width	11.81 in (30.000 cm)
Package 2 Length	15.75 in (40.000 cm)
Package 2 Weight	9.11 lb(US) (4.130 kg)

Contractual warranty

Warranty	18 months
----------	-----------

TM5 Slice

Dimensions

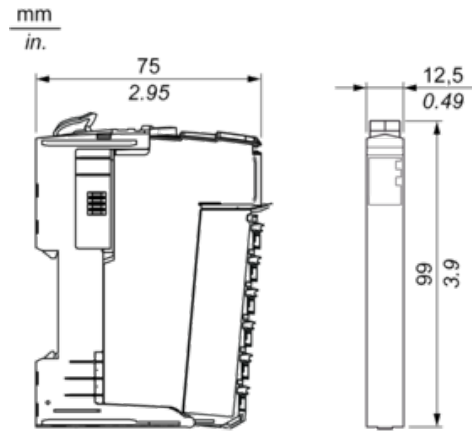

TM5 System

Spacing Requirements

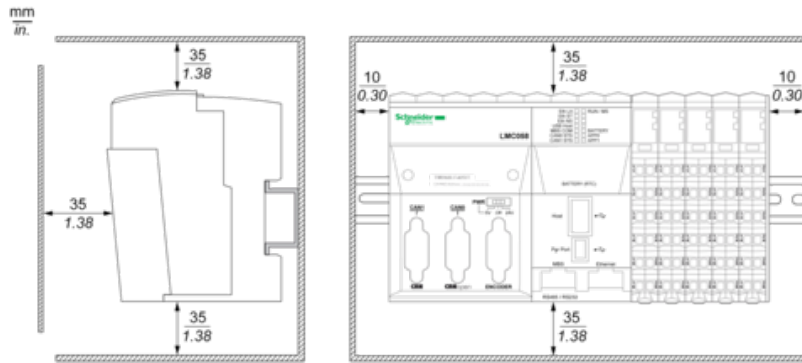



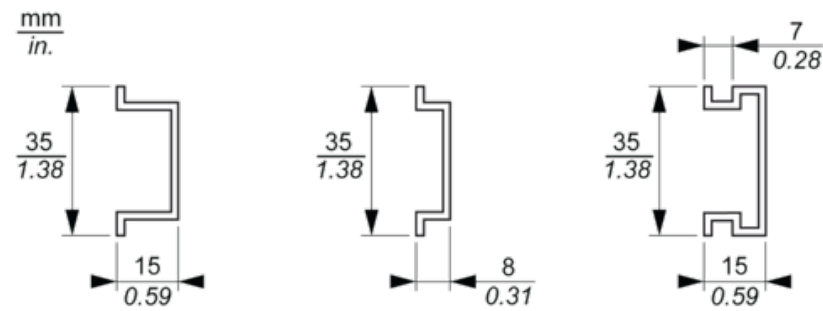

Mounting on a DIN Rail



TM5 System Wiring Recommendations

Wire Sizes to Use with the Removable Spring Terminal Blocks

$\frac{\text{mm}}{\text{in.}}$ 				
mm ²	0,08...2,5	0,25...2,5	0,25...1,5	2 x 0,25...2 x 0,75
AWG	28...14	24...14	24...16	2 x 24...2 x 18

Electronic Module 12 x 24 Vdc

Wiring Diagrams

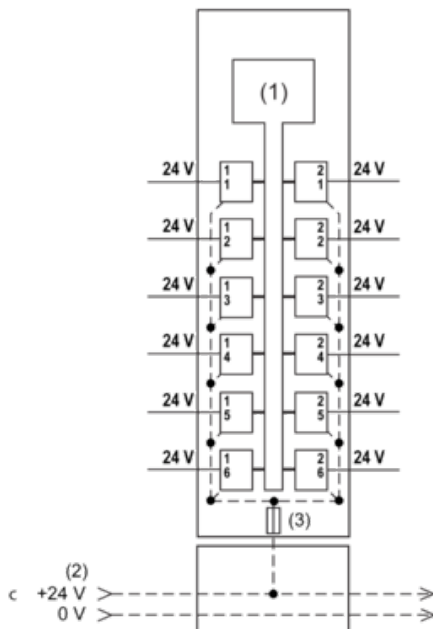

- (1) Internal electronics
 - (2) 24 Vdc I/O power segment integrated into the bus bases
 - (3) Integrated fuse type T slow-blow 6.3 A 250 V exchangeable
- The following figure shows the wiring diagram with a TM5SDI12D: