

## High temperature 16 A SCRs

Datasheet - production data

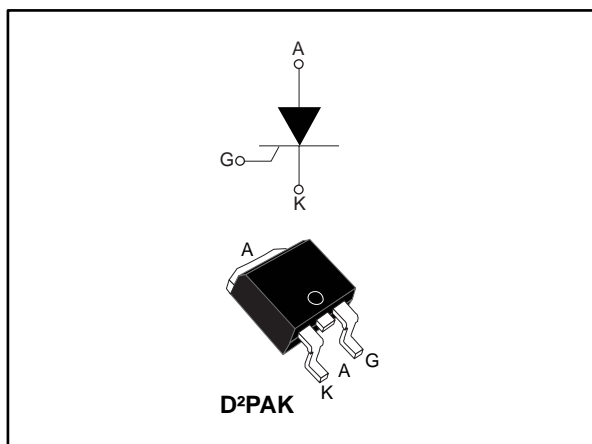

### Description

Designed with high immunity switching to external surges, this device offers robust switching up to its 150°C maximum  $T_j$ .

The combination of noise immunity and low gate triggering current allows to design strong and compact control circuit.

**Table 1: Device summary**

Order code	Package	$V_{DRM}/V_{RRM}$	$I_{GT}$
TN1605H-6G	D <sup>2</sup> PAK	600	6 mA

### Features

- High junction temperature:  $T_j = 150\text{ °C}$
- Gate triggering current  $I_{GT} = 6\text{ mA}$
- High noise immunity  $dV/dt = 200\text{ V}/\mu\text{s}$  up to 150 °C
- Blocking voltage  $V_{DRM}/V_{RRM} = 600\text{ V}$
- High turn-on current rise  $dI/dt: 100\text{ A}/\mu\text{s}$
- ECOPACK<sup>®</sup>2 compliant component

### Applications

- Motorbikes voltage regulator circuits
- Inrush current limiting circuits
- Motor control circuits and starters
- Light dimmers
- Solid state relays

# 1 Characteristics

**Table 2: Absolute maximum ratings (limiting values,  $T_j = 25\text{ °C}$  unless otherwise specified)**

Symbol	Parameter		Value	Unit	
$I_{T(RMS)}$	RMS on-state current (180° conduction angle)		$T_c = 133\text{ °C}$	16	A
$I_{T(AV)}$	Average on-state current (180° conduction angle)		$T_c = 133\text{ °C}$	10	A
			$T_c = 138\text{ °C}$	8	
			$T_c = 142\text{ °C}$	6	
$I_{TSM}$	Non repetitive surge peak on-state current	$t_p = 8.3\text{ ms}$	$T_j\text{ initial} = 25\text{ °C}$	153	A
		$t_p = 10\text{ ms}$		140	
$I^2t$	$I^2t$ value for fusing	$t_p = 10\text{ ms}$		98	$A^2s$
$di/dt$	Critical rate of rise of on-state current	$I_G = 2 \times I_{GT}$ , $t_r \leq 100\text{ ns}$ ,	$f = 60\text{ Hz}$	100	$A/\mu s$
$V_{DRM}/V_{RRM}$	Repetitive peak off-state voltage		$T_j = 150\text{ °C}$	600	V
$V_{DSM}/V_{RSM}$	Non repetitive surge peak off- state voltage	$t_p = 10\text{ ms}$		700	V
$P_G(AV)$	Average gate power dissipation		$T_j = 150\text{ °C}$	1	W
$V_{RGM}$	Maximum peak reverse gate voltage			5	V
$I_{GM}$	Peak gate current	$t_p = 20\text{ }\mu s$	$T_j = 150\text{ °C}$	4	A
$T_{stg}$	Storage junction temperature range			-40 to +150	$^{\circ}C$
$T_j$	Operating junction temperature range			-40 to +150	$^{\circ}C$

**Table 3: Dynamic characteristics**

Symbol	Parameter	$T_j$		Value	Unit
$I_{GT}$	$V_D = 12\text{ V}$ , $R_L = 33\text{ }\Omega$	25 $^{\circ}C$	Min.	3.5	mA
		Typ.		4.5	
		Max.		6	
$V_{GT}$		Max.		1.3	V
$V_{GD}$	$V_D = 600$ , $R_L = 3.3\text{ k}\Omega$	150 $^{\circ}C$	Min.	0.15	V
$I_L$	$I_G = 1.2 \times I_{GT}$	25 $^{\circ}C$	Max.	40	mA
$I_H$	$I_T = 500\text{ mA}$ , gate open		Max.	20	
$dV/dt$	$V_D = 402\text{ V}$ , gate open	150 $^{\circ}C$	Min.	200	$V/\mu s$
$t_{gt}$	$I_{TM} = 32\text{ A}$ , $V_D = 402\text{ V}$ , $I_G = 12\text{ mA}$ , $(di_G/dt)$ max = 0.2 $A/\mu s$	25 $^{\circ}C$	Typ.	1.9	$\mu s$
$t_q$	$I_{TM} = 32\text{ A}$ , $V_D = 402\text{ V}$ , $(di/dt)_{off} = 30\text{ A}/\mu s$ , $V_R = 25\text{ V}$ , $dV_D/dt = 20\text{ V}/\mu s$	150 $^{\circ}C$	Typ.	70	$\mu s$

Table 4: Static electrical characteristics

Symbol	Test conditions	$T_j$		Value	Unit
$V_{TM}$	$I_{TM} = 32 \text{ A}$ , $t_p = 380 \mu\text{s}$	25 °C	Max.	1.6	V
$V_{TO}$	Threshold on-state voltage	150 °C	Max.	0.82	V
$R_D$	Dynamic resistance	150 °C	Max.	25	m $\Omega$
$I_{DRM}/I_{RRM}$	$V_{DRM} = V_{RRM}$	25 °C	Max.	5	$\mu\text{A}$
		125 °C		1.5	mA
		150 °C		3.1	

Table 5: Thermal resistance

Symbol	Parameter			Value	Unit
$R_{th(j-c)}$	Junction to case (DC)		Max.	1.1	$^{\circ}\text{C}/\text{W}$
$R_{th(j-a)}$	Junction to ambient (DC)	$S^{(1)} = 1 \text{ cm}^2$	Typ.	45	

**Notes:**

<sup>(1)</sup>S = copper surface under tab

# 1.1 Characteristics (curves)

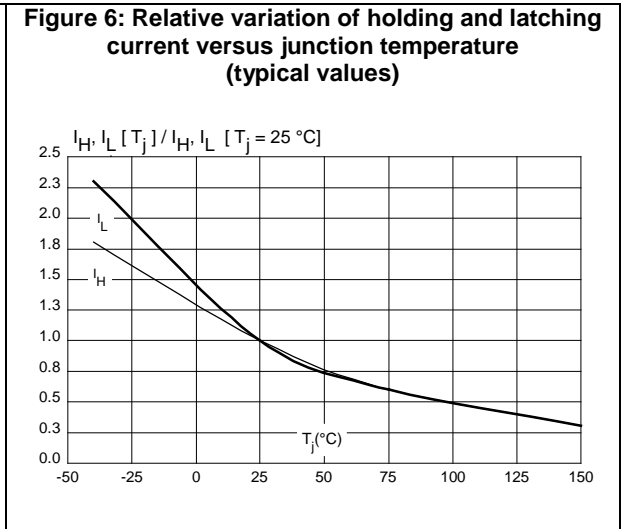
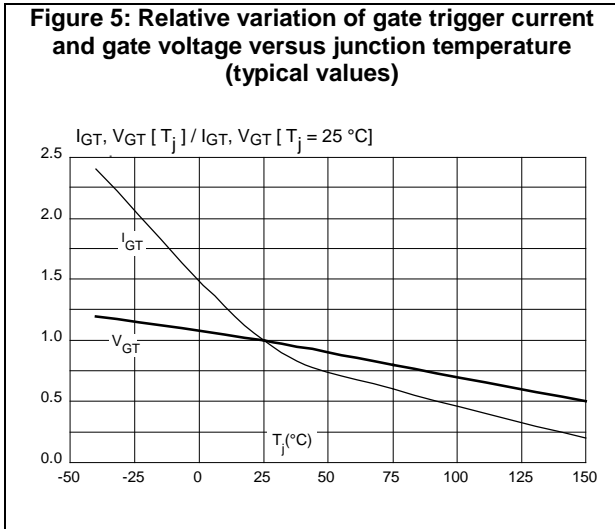
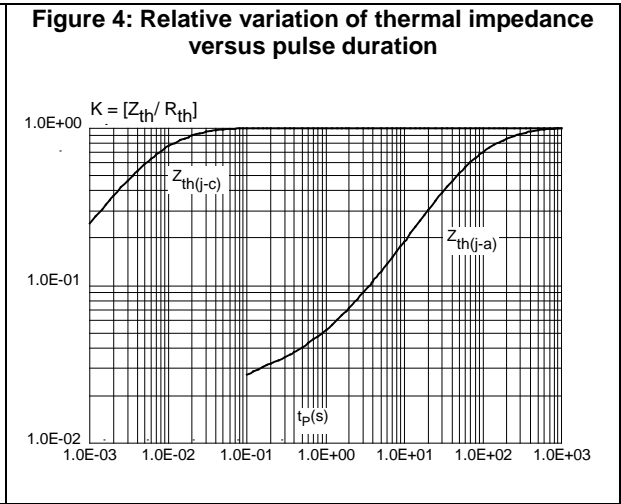
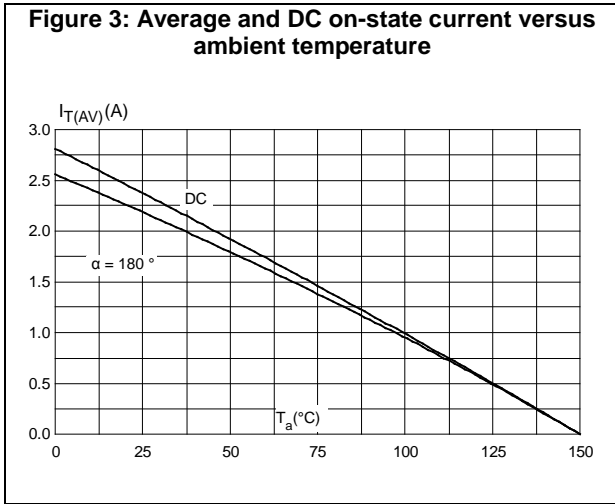
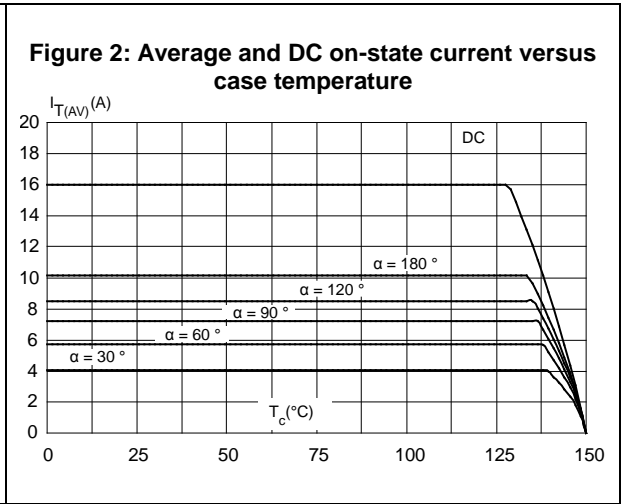
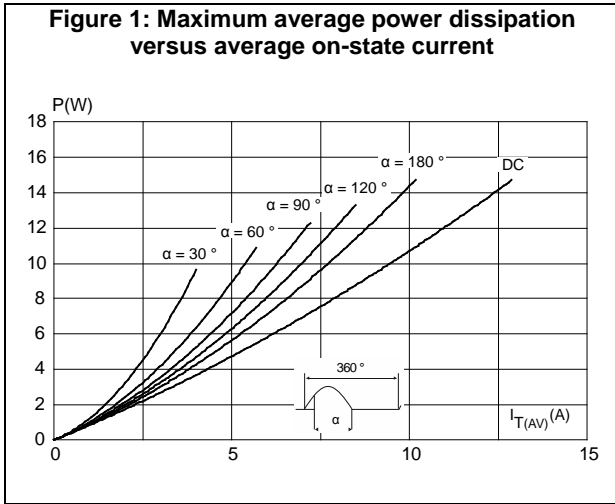

**Figure 7: Relative variation of static dV/dt immunity versus junction temperature (typical values)**

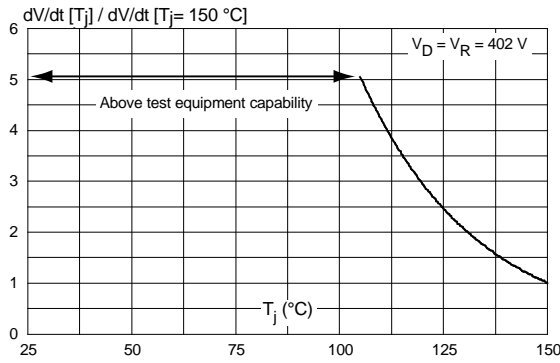

**Figure 8: Surge peak on-state current versus number of cycles**

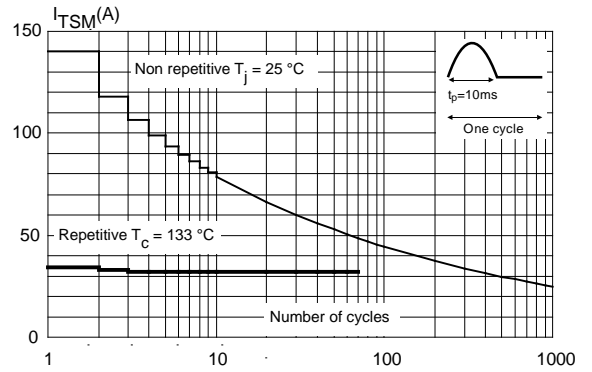

**Figure 9: Non repetitive surge peak on-state current versus sinusoidal pulse width (tp < 10 ms).**

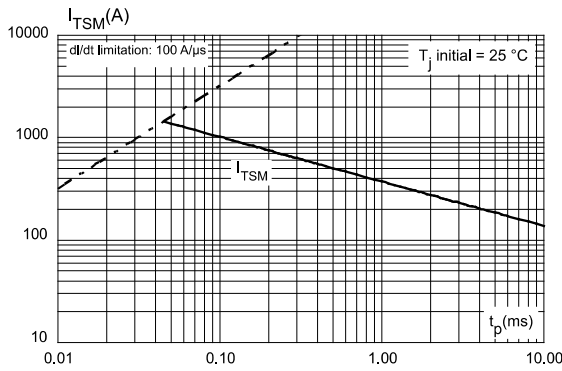

**Figure 10: On-state characteristics (maximum values)**

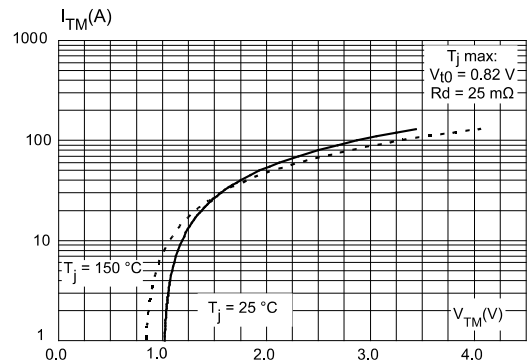

**Figure 11: Relative variation of leakage current versus junction temperature (tP < 10ms)**

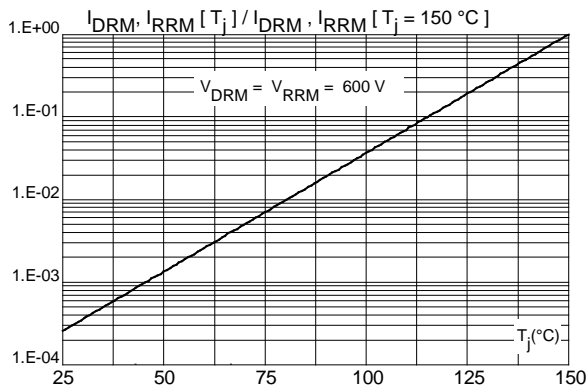

## 2 Package information

In order to meet environmental requirements, ST offers these devices in different grades of ECOPACK® packages, depending on their level of environmental compliance. ECOPACK® specifications, grade definitions and product status are available at: [www.st.com](http://www.st.com). ECOPACK® is an ST trademark.

- Epoxy meets UL 94,V0
- Lead-free package

### 2.1 D<sup>2</sup>PAK package information

Figure 12: D<sup>2</sup>PAK package outline

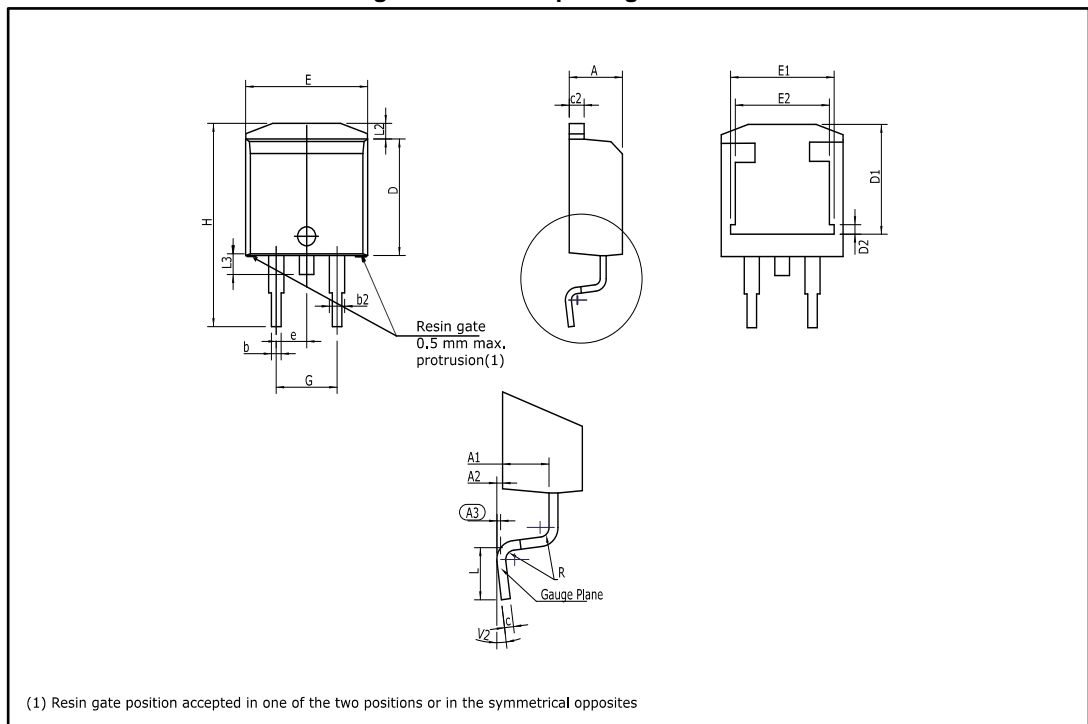
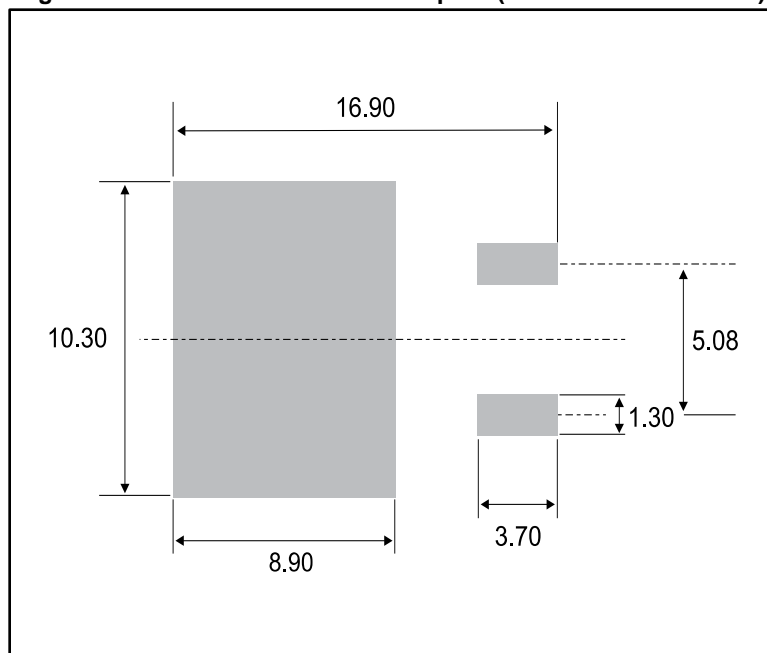

Table 6: D<sup>2</sup>PAK package mechanical data

Ref.	Dimensions					
	Millimeters			Inches <sup>(1)</sup>		
	Min.	Typ.	Max.	Min.	Typ.	Max.
A	4.30		4.60	0.1693		0.1811
A1	2.49		2.69	0.0980		0.1059
A2	0.03		0.23	0.0012		0.0091
A3		0.25			0.0098	
b	0.70		0.93	0.0276		0.0366
b2	1.25		1.7	0.0492		0.0669
c	0.45		0.60	0.0177		0.0236
c2	1.21		1.36	0.0476		0.0535
D	8.95		9.35	0.3524		0.3681
D1	7.50		8.00	0.2953		0.3150
D2	1.30		1.70	0.0512		0.0669
e	2.54			0.1		
E	10.00		10.28	0.3937		0.4047
E1	8.30		8.70	0.3268		0.3425
E2	6.85		7.25	0.2697		0.2854
G	4.88		5.28	0.1921		0.2079
H	15		15.85	0.5906		0.6240
L	1.78		2.28	0.0701		0.0898
L2	1.27		1.40	0.0500		0.0551
L3	1.40		1.75	0.0551		0.0689
R		0.40			0.0157	
V2	0°		8°	0°		8°

**Notes:**<sup>(1)</sup>Dimensions in inches are given for reference only

Figure 13: D<sup>2</sup>PAK recommended footprint (dimensions are in mm)





### 3 Ordering information

Figure 14: Ordering information scheme

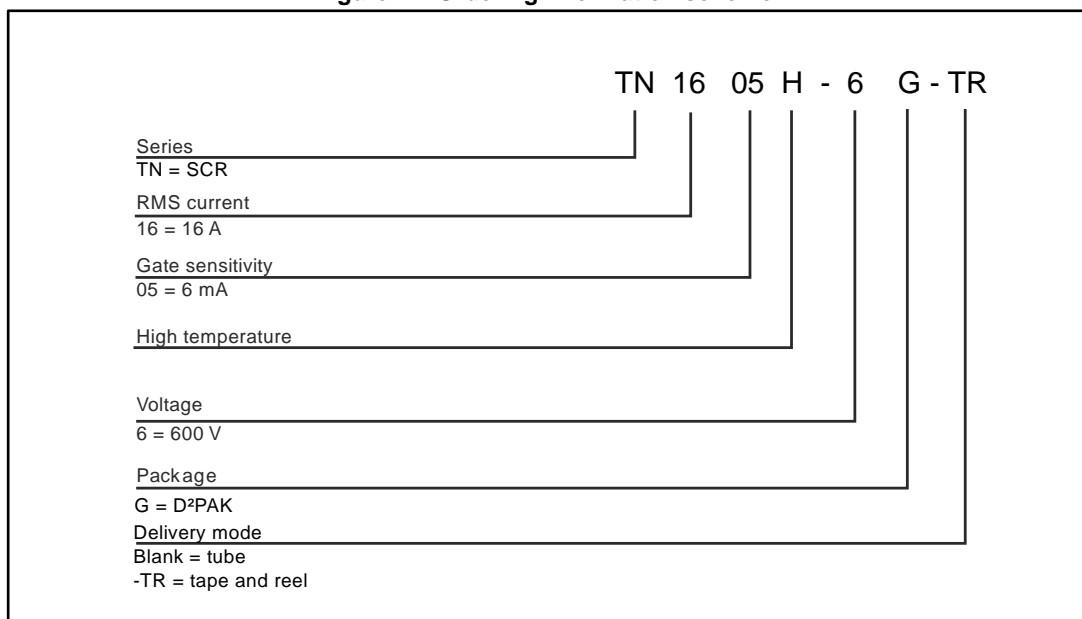

Table 7: Ordering information

Order code	Marking	Package	Weight	Base qty.	Delivery mode
TN1605H-6G	TN1605H6	D <sup>2</sup> PAK	1.5 g	50	Tube
TN1605H-6G-TR				1000	Tape and reel

### 4 Revision history

Table 8: Document revision history

Date	Revision	Changes
18-May-2017	1	Initial release.
26-Jun-2017	2	Updated <a href="#">Table 5: "Thermal resistance"</a> .