

Features

- On-state rms current, $I_{T(RMS)}$ 25 A
- Repetitive peak off-state voltage, V_{DRM}/V_{RRM} 600 to 1200 V
- Triggering gate current, I_{GT} 40 mA
- Insulated package TO-220AB ins
 - Insulating voltage 2500 V rms
 - UL1557 certified (file ref. E81734)

Description

These standard 25 A SCRs are suitable for general purpose applications.

Using clip assembly technology, they provide a superior performance in surge current capabilities.

TXN625RG is packaged in TO-220AB ins.

Table 1. Device summary

| Order code | Voltage V_{DRM}/V_{RRM} | | | Sensitivity I_{GT} | Package |
|----------------|---------------------------|-------|--------|-------------------------|--------------------|
| | 600 V | 800 V | 1200 V | | |
| TN2540-600G-TR | Y | | | 40 mA | D ² PAK |
| TN2540-800G-TR | | Y | | 40 mA | D ² PAK |
| TXN625RG | Y | | | 40 mA | TO-220AB ins |
| TYN625RG | Y | | | 40 mA | TO-220AB |
| TYN825RG | | Y | | 40 mA | TO-220AB |
| TYN1225RG | | | Y | 40 mA | TO-220AB |

1 Characteristics

Table 2. Absolute ratings (limiting values)

| Symbol | Parameter | | Value | Unit | |
|--------------------|---|------------------------------|-----------------------|--------------------------------|------------------|
| $I_{T(RMS)}$ | On-state rms current (180 °Conduction angle) | TO-220AB, D ² PAK | $T_c = 100\text{ °C}$ | 25 | A |
| | | TO-220AB ins | $T_c = 83\text{ °C}$ | | |
| $I_{T(AV)}$ | Average on-state current (180 °Conduction angle) | | $T_c = 100\text{ °C}$ | 16 | A |
| I_{TSM} | Non repetitive surge peak on-state current | $t_p = 8.3\text{ ms}$ | $T_j = 25\text{ °C}$ | 314 | A |
| | | $t_p = 10\text{ ms}$ | | 300 | |
| I^2t | I^2t Value for fusing | $t_p = 10\text{ ms}$ | $T_j = 25\text{ °C}$ | 450 | A ² s |
| dI/dt | Critical rate of rise of on-state current $I_G = 2 \times I_{GT}$, $t_r \leq 100\text{ ns}$ | F = 60 Hz | $T_j = 125\text{ °C}$ | 50 | A/ μ s |
| I_{GM} | Peak gate current | $t_p = 20\text{ }\mu$ s | $T_j = 125\text{ °C}$ | 4 | A |
| $P_{G(AV)}$ | Average gate power dissipation | | $T_j = 125\text{ °C}$ | 1 | W |
| T_{stg} T_j | Storage junction temperature range Operating junction temperature range | | | - 40 to + 150 - 40 to + 125 | °C |
| V_{RGM} | Maximum peak reverse gate voltage | | | 5 | V |

Table 3. Electrical Characteristics ($T_j = 25\text{ °C}$, unless otherwise specified)

| Symbol | Test conditions | | Value | Unit | | |
|------------------------|---|-----------------------|-----------------------|------|------------|------------|
| I_{GT} | $V_D = 12\text{ V}$ $R_L = 33\text{ }\Omega$ | MIN. | 4 | mA | | |
| | | MAX. | 40 | | | |
| V_{GT} | | MAX. | 1.3 | V | | |
| V_{GD} | $V_D = V_{DRM}$ $R_L = 3.3\text{ k}\Omega$ | $T_j = 125\text{ °C}$ | MIN. | 0.2 | V | |
| I_H | $I_T = 500\text{ mA}$ Gate open | | MAX. | 50 | mA | |
| I_L | $I_G = 1.2 \times I_{GT}$ | | MAX. | 90 | mA | |
| dV/dt | $V_D = 67\% V_{DRM}$ Gate open | $T_j = 125\text{ °C}$ | MIN. | 1500 | V/ μ s | |
| V_{TM} | $I_{TM} = 50\text{ A}$ $t_p = 380\text{ }\mu$ s | $T_j = 25\text{ °C}$ | MAX. | 1.6 | V | |
| V_{t0} | Threshold voltage | | $T_j = 125\text{ °C}$ | MAX. | 0.77 | V |
| R_d | Dynamic resistance | | $T_j = 125\text{ °C}$ | MAX. | 14 | m Ω |
| I_{DRM} I_{RRM} | $V_{DRM} = V_{RRM}$ | $T_j = 25\text{ °C}$ | MAX. | 5 | μ A | |
| | | $T_j = 125\text{ °C}$ | | 4 | mA | |

Table 4. Thermal resistances

| Symbol | Parameter | | Value | Unit | |
|---------------|--------------------------|------------------------------|------------------------|------|------|
| $R_{th(j-c)}$ | Junction to case (DC) | D ² PAK, TO-220AB | 1.0 | °C/W | |
| | | TO-220AB ins | 2.0 | | |
| $R_{th(j-a)}$ | Junction to ambient (DC) | $S^{(1)} = 1 \text{ cm}^2$ | D ² PAK | 45 | °C/W |
| | | | TO-220AB, TO-220AB ins | 60 | |

1. S = Copper surface under tab.

Figure 1. Maximum average power dissipation versus average on-state current

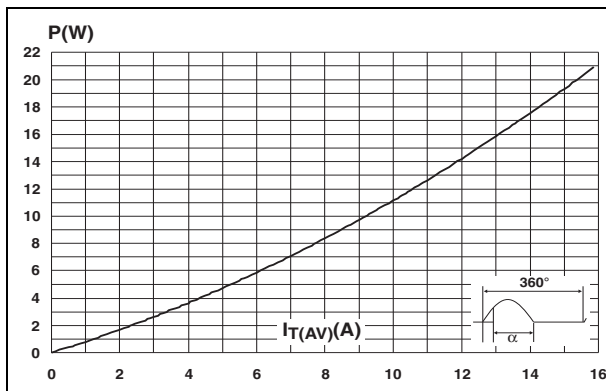

Figure 2. Average and DC on-state current versus case temperature

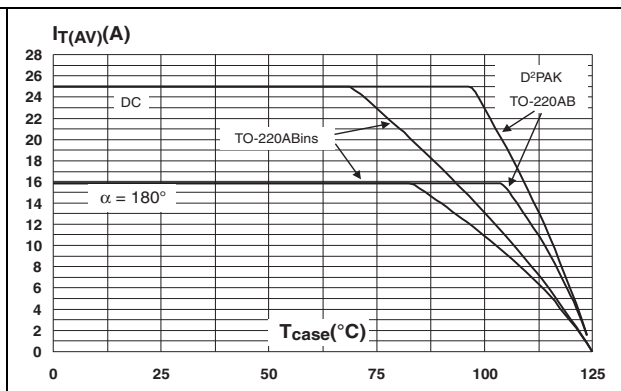

Figure 3. Average and DC on-state current versus ambient temperature

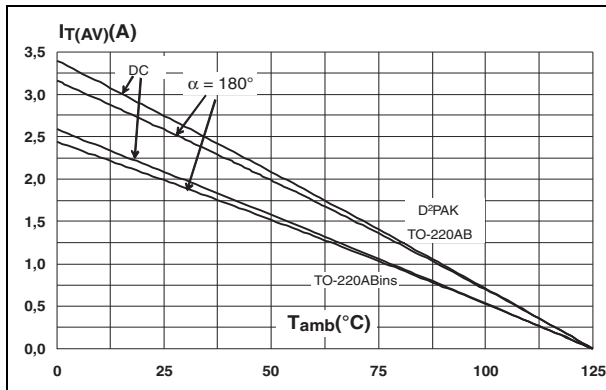

Figure 4. Relative variation of thermal impedance versus pulse duration (D²PAK, and TO-220AB)

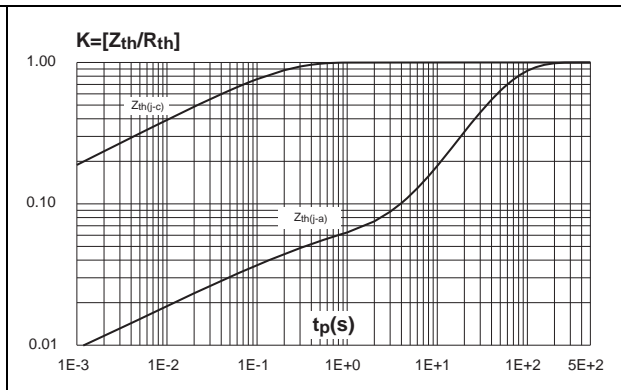

Figure 5. Relative variation of thermal impedance versus pulse duration (TO-220AB ins)

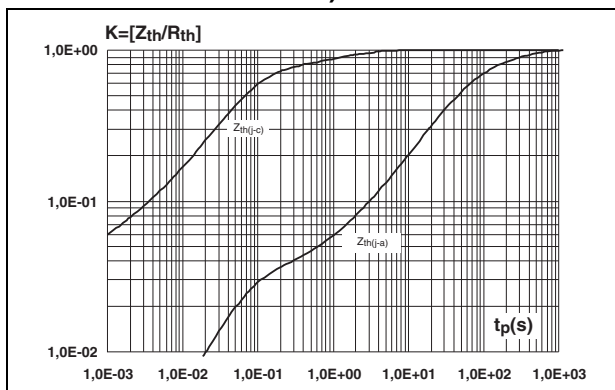

Figure 6. Relative variation of gate trigger, holding, and latching currents versus junction temperature

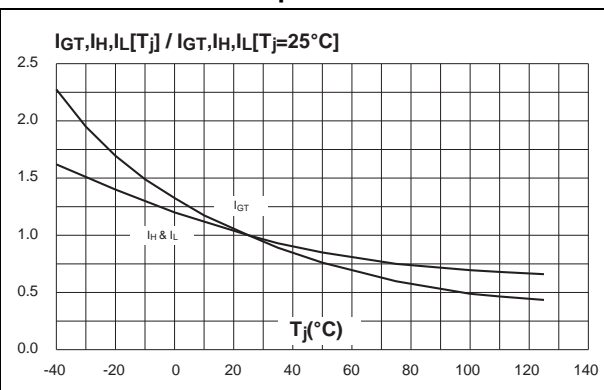

Figure 7. Surge peak on-state current versus number of cycles

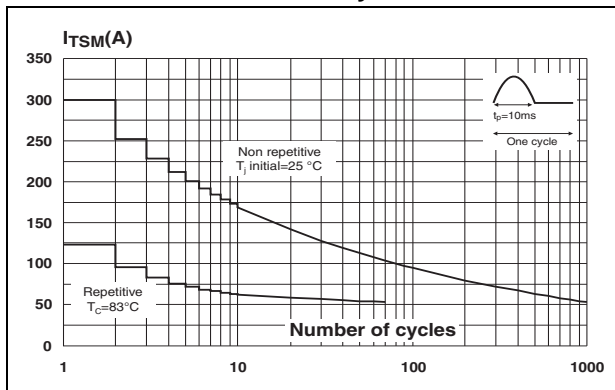

Figure 8. Non-repetitive surge peak on-state current, and corresponding values of I²t

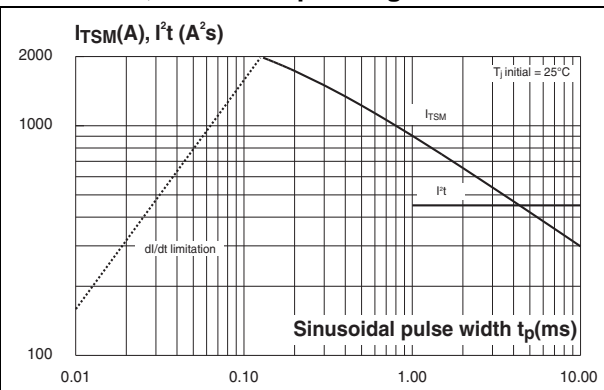

Figure 9. On-state characteristics (maximum values)

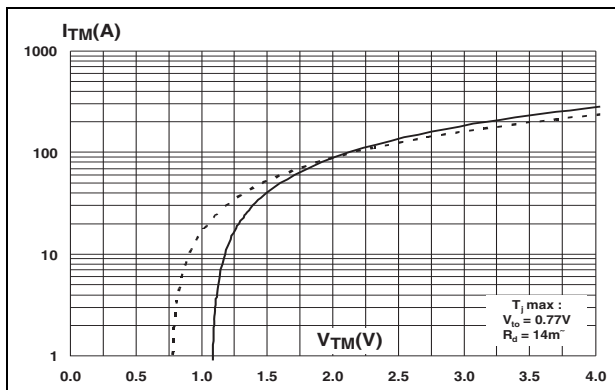
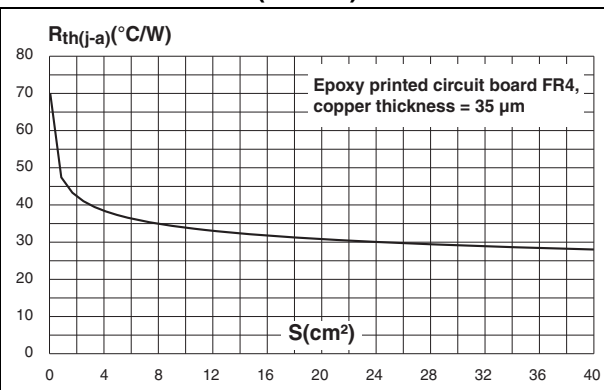

Figure 10. Thermal resistance junction to ambient versus copper surface under tab (D²PAK)



2 Ordering information schemes

Figure 11. TN2540-x00G ordering information scheme

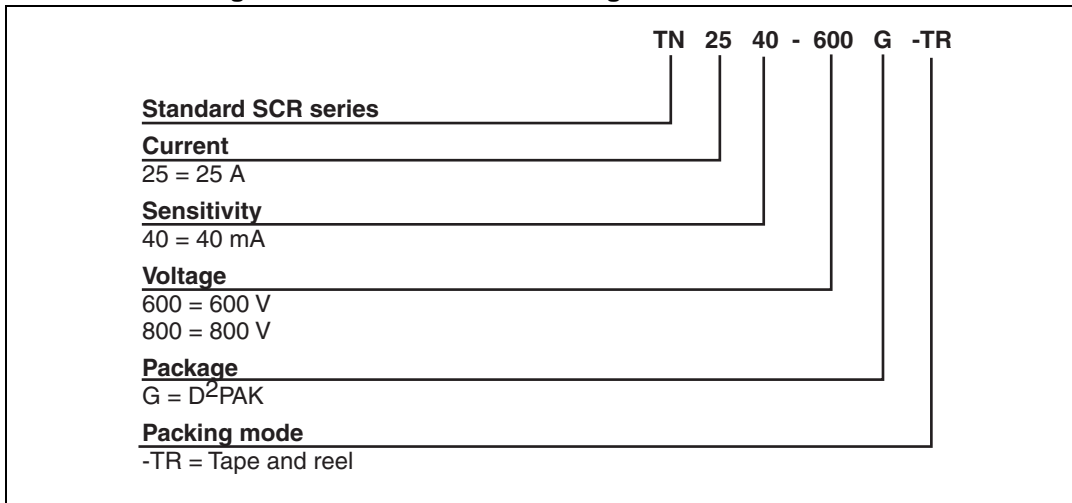

Figure 12. TXN625RG ordering information scheme

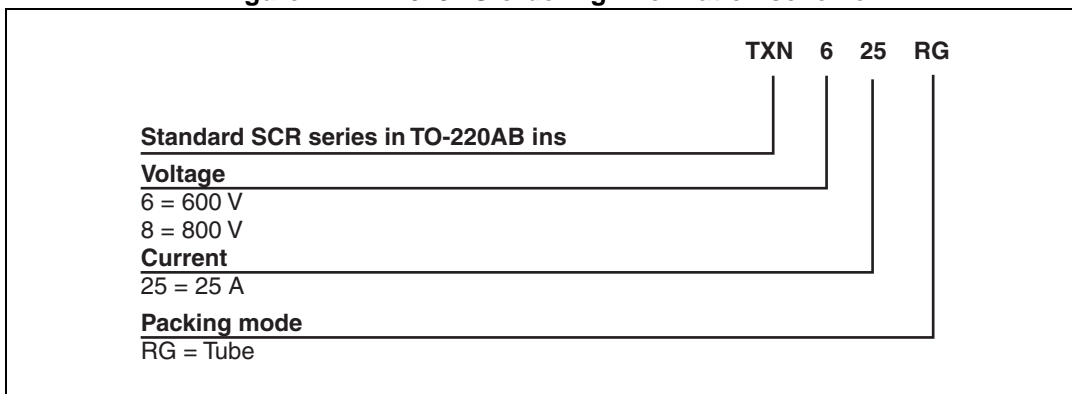
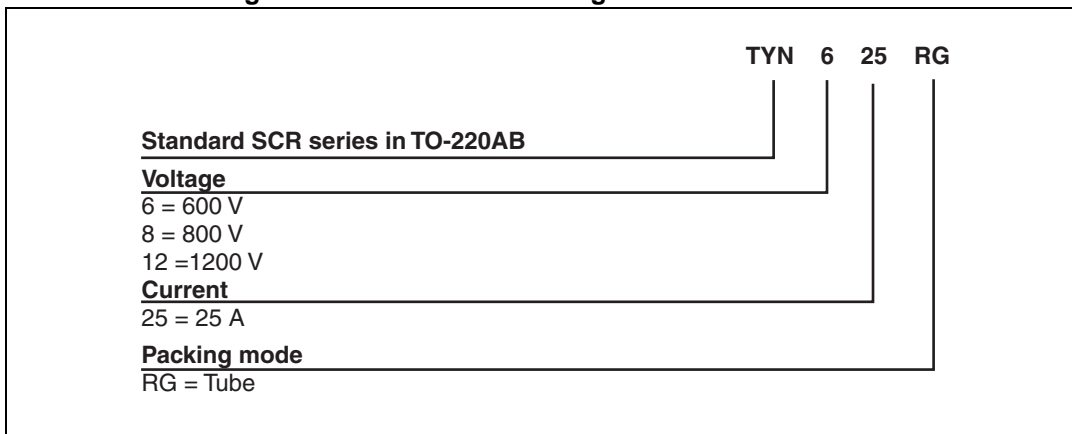

Figure 13. TYNx25RG ordering information scheme



3 Package information

- Epoxy meets UL94, V0
- Lead-free package
- Recommended torque values (TO-220AB, and TO220AB ins): 0.4 to 0.6 N·m

In order to meet environmental requirements, ST offers these devices in different grades of ECOPACK® packages, depending on their level of environmental compliance. ECOPACK® specifications, grade definitions and product status are available at: www.st.com. ECOPACK® is an ST trademark.

Figure 14. TO-220AB (Nlns. & Ins. 20-up) dimension definitions

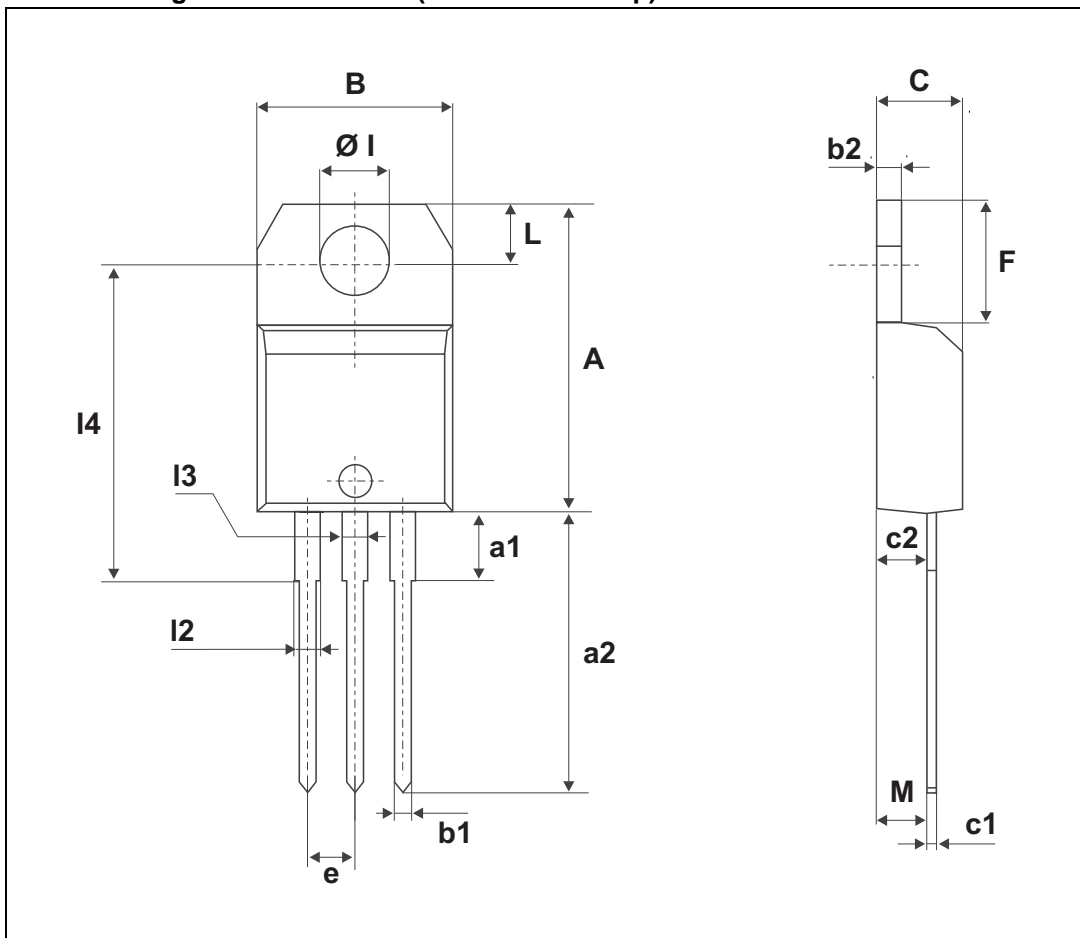

Table 5. TO-220AB (Nlns. & Ins. 20-up) dimension values

| Ref. | Dimensions | | | | | |
|------|-------------|-------|-------|--------|-------|-------|
| | Millimeters | | | Inches | | |
| | Min. | Typ. | Max. | Min. | Typ. | Max. |
| A | 15.20 | | 15.90 | 0.598 | | 0.625 |
| a1 | | 3.75 | | | 0.147 | |
| a2 | 13.00 | | 14.00 | 0.511 | | 0.551 |
| B | 10.00 | | 10.40 | 0.393 | | 0.409 |
| b1 | 0.61 | | 0.88 | 0.024 | | 0.034 |
| b2 | 1.23 | | 1.32 | 0.048 | | 0.051 |
| C | 4.40 | | 4.60 | 0.173 | | 0.181 |
| c1 | 0.49 | | 0.70 | 0.019 | | 0.027 |
| c2 | 2.40 | | 2.70 | 0.094 | | 0.107 |
| e | 2.40 | | 2.70 | 0.094 | | 0.106 |
| F | 6.20 | | 6.60 | 0.244 | | 0.259 |
| ØI | 3.75 | | 3.85 | 0.147 | | 0.151 |
| l4 | 15.80 | 16.40 | 16.80 | 0.622 | 0.646 | 0.661 |
| L | 2.65 | | 2.95 | 0.104 | | 0.116 |
| l2 | 1.14 | | 1.70 | 0.044 | | 0.066 |
| l3 | 1.14 | | 1.70 | 0.044 | | 0.066 |
| M | | 2.60 | | | 0.102 | |

Figure 15. D²PAK dimensions definitions

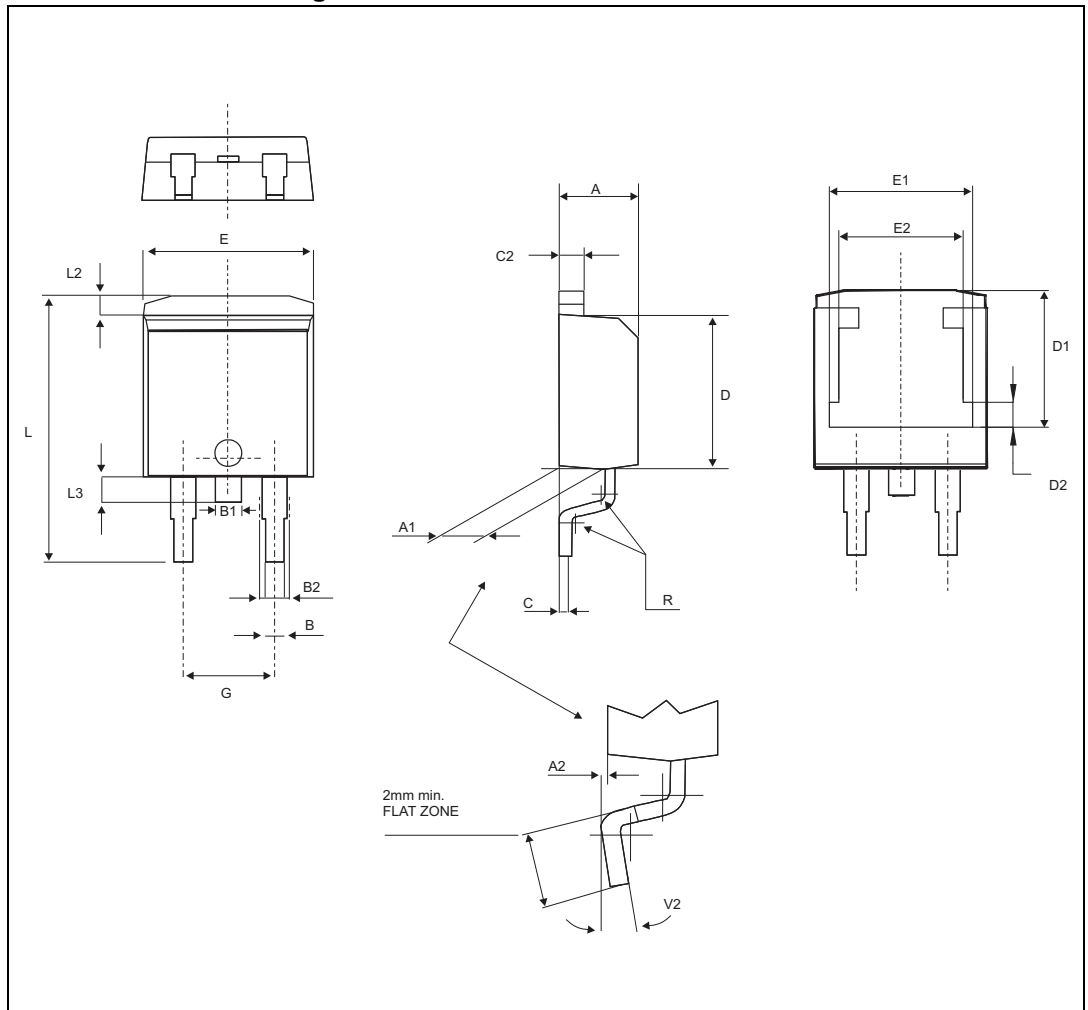
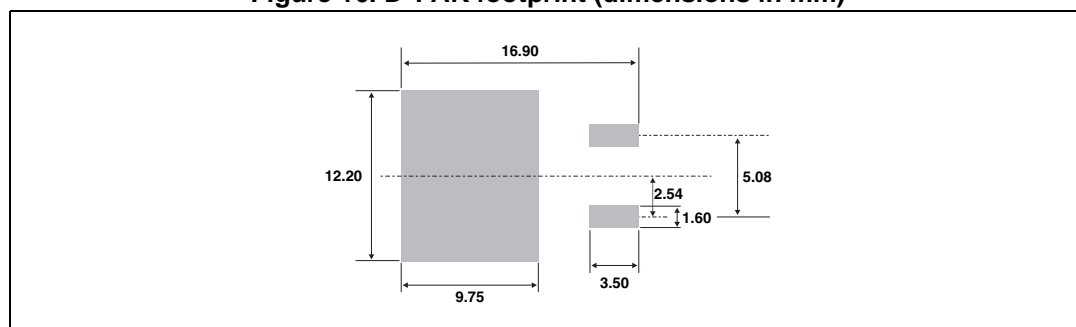

Table 6. D²PAK dimensions values

| Ref. | Dimensions | | | | | |
|------|-------------|------|-------|--------|-------|-------|
| | Millimeters | | | Inches | | |
| | Min. | Typ. | Max. | Min. | Typ. | Max. |
| A | 4.30 | | 4.60 | 0.169 | | 0.181 |
| A1 | 2.49 | | 2.69 | 0.098 | | 0.106 |
| A2 | 0.03 | | 0.23 | 0.001 | | 0.009 |
| B | 0.70 | | 0.93 | 0.027 | | 0.037 |
| B1 | 1.20 | | 1.38 | 0.047 | | 0.054 |
| B2 | 1.25 | 1.40 | | 0.048 | 0.055 | |
| C | 0.45 | | 0.60 | 0.017 | | 0.024 |
| C2 | 1.21 | | 1.36 | 0.047 | | 0.054 |
| D | 8.95 | | 9.35 | 0.352 | | 0.368 |
| D1 | 7.5 | | 8.0 | 0.295 | | 0.314 |
| D2 | 1.3 | | 1.7 | 0.051 | | 0.067 |
| E | 10.00 | | 10.28 | 0.393 | | 0.405 |
| E1 | 8.3 | | 8.7 | 0.326 | | 0.342 |
| E2 | 6.85 | | 7.25 | 0.269 | | 0.285 |
| G | 4.88 | | 5.28 | 0.192 | | 0.208 |
| L | 15.00 | | 15.85 | 0.590 | | 0.624 |
| L2 | 1.27 | | 1.40 | 0.050 | | 0.055 |
| R | 0.40 | | | 0.016 | | |
| V2 | 0° | | 8° | 0° | | 8° |

Figure 16. D²PAK footprint (dimensions in mm)

4 Ordering information

Table 7. Ordering information

| Order code | Voltage | Sensitivity | Marking | Package | Weight | Base qty | Delivery mode |
|----------------|---------|-------------|------------|--------------------|--------|----------|---------------|
| TN2540-600G-TR | 600 V | 40 mA | TN2540600G | D ² PAK | 1.5 g | 1000 | Tape & reel |
| TN2540-800G-TR | 800 V | 40 mA | TN2540800G | D ² PAK | 1.5 g | 1000 | Tape & reel |
| TXN625RG | 600 V | 40 mA | TXN625 | TO-220AB ins | 2.3 g | 50 | Tube |
| TYN625RG | 600 V | 40 mA | TYN625 | TO-220AB | 2.3 g | 50 | Tube |
| TYN825RG | 800 V | 40 mA | TYN825 | TO-220AB | 2.3 g | 50 | Tube |
| TYN1225RG | 1200 V | 40 mA | TYN1225 | TO-220AB | 2.3 g | 50 | Tube |

5 Revision history

Table 8. Document revision history

| Date | Revision | Changes |
|-------------|----------|---|
| Apr-2002 | 4A | Previous update |
| 13-Feb-2006 | 5 | TO-220AB delivery mode changed from bulk to tube. ECOPACK statement added. |
| 17-Jun-2011 | 6 | Added TXN625. |
| 13-Sep-2011 | 7 | Added UL certification in Features . |
| 07-Feb-2012 | 8 | Added TYN1225. |
| 20-Aug-2014 | 9 | Updated Section 3: Package information . |