

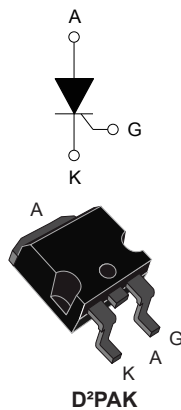

30 A – 1200 V automotive grade SCR Thyristor



Features

- AEC-Q101 qualified 
- High junction temperature: $T_j = 150\text{ }^\circ\text{C}$
- AC off state voltage: +/- 1200 V
- Nominal on-state current: $30\text{ }A_{RMS}$
- High noise immunity: $1000\text{ V}/\mu\text{s}$
- Max. gate triggering current: 50 mA
- ECOPACK®2 compliant component

Applications

- Automotive applications: on board and off board battery charger
- Renewable energy inverters
- Solid state relay
- 3-Phase heating or motor soft start control
- UPS (uninterruptible power supply)
- Bypass SSR / hybrid relay
- Inrush current limiter in battery charger
- AC-DC voltage controlled rectifier
- Industrial welding systems

Product status link

[TN3050H-12GY-TR](#)

Product summary

$I_{T(RMS)}$	30 A
V_{DRM}/V_{RRM}	1200 V
V_{DSM}/V_{RSM}	1400 V
I_{GT}	50 mA
T_j	150 °C

Description

The **TN3050H-12GY-TR** is an automotive grade SCR Thyristor designed for applications such as automotive on-board chargers, AC solid state relays and stationary battery chargers.

Rated for a $30\text{ }A_{RMS}$ power switching, This SCR Thyristor offers superior performance in terms of peak voltage robustness (up to 1400 V) and surge current handling (sine wave pulse up to 300 A). Its key features allow the design of functions such as a $42\text{ }A_{RMS}$ AC switch (dual back-to-back SCRs) and a 38 A average AC-DC controlled rectifier bridge for inrush current limitation.

Available in D²PAK package, it is ideal for compact SMD designs on surface mount boards or insulated metal substrate boards.

1 Characteristics

Table 1. Absolute ratings (limiting values)

Symbol	Parameter		Value	Unit
$I_{T(RMS)}$	RMS on-state current (180 ° conduction angle)		30	A
$I_{T(AV)}$	Average on-state current (180 ° conduction angle)			
$I_{TSM}^{(1)}$	Non repetitive surge peak on-state current, $V_R = 0\text{ V}$	$t_p = 8.3\text{ ms}$	330	A
		$t_p = 10\text{ ms}$		
V_{DRM} / V_{RRM}	Repetitive off-state voltage (50-60 Hz)		1200	V
di/dt	Critical rate of rise of on-state current $I_G = 2 \times I_{GT}$, $t_r \leq 100\text{ ns}$	$f = 50\text{ Hz}$	200	A/ μs
V_{GM}	Peak forward gate voltage	$t_p = 20\text{ }\mu\text{s}$	10	V
I_{GM}	Peak forward gate current		8	A
$P_{G(AV)}$	Average gate power dissipation		1	W
V_{RGM}	Peak reverse gate voltage		5	V
T_{stg}	Storage junction temperature range			-40 to +150 °C
T_j	Operating junction temperature			-40 to +150 °C

1. ST recommend I^2t value for fusing = 450 A²s for $T_j = 25\text{ °C}$ and $t_p = 10\text{ ms}$

Table 2. Electrical characteristics ($T_j = 25\text{ °C}$ unless otherwise specified)

Symbol	Test conditions		Value	Unit	
I_{GT}	$V_D = 12\text{ V}$, $R_L = 33\text{ }\Omega$		Min.	10	
			Max.	50	
V_{GT}	$V_D = 12\text{ V}$, $R_L = 33\text{ }\Omega$		Max.	1.3	
V_{GD}	$V_D = 2/3 \times V_{DRM}$, $R_L = 3.3\text{ k}\Omega$	$T_j = 150\text{ °C}$	Min.	0.2	
I_H	$I_T = 500\text{ mA}$, gate open		Max.	100	
I_L	$I_G = 1.2 \times I_{GT}$		Max.	125	
t_{gt}	$I_T = 60\text{ A}$, $V_D = 2/3 \times V_{DRM}$, $I_G = 100\text{ mA}$, $di_G/dt = 0.2\text{ A}/\mu\text{s}$		Typ.	1	
dV/dt	$V_D = 2/3 \times V_{DRM}$, gate open	$T_j = 150\text{ °C}$	Min.	1000	
t_q	$I_T = 20\text{ A}$, $di_T/dt = 10\text{ A}/\mu\text{s}$, $V_R = 75\text{ V}$, $V_D = 2/3 \times V_{DRM}$, $dV_D/dt = 20\text{ V}/\mu\text{s}$, $t_p = 100\text{ }\mu\text{s}$	$T_j = 150\text{ °C}$	Typ.	150	
V_{TM}	$I_{TM} = 60\text{ A}$, $t_p = 380\text{ }\mu\text{s}$		Max.	1.65	
V_{TO}	Threshold voltage		Max.	0.88	
R_D	Dynamic resistance		Max.	14	
I_{DRM}/I_{RRM}	$V_D = V_{DRM}$, $V_R = V_{RRM}$		$T_j = 25\text{ °C}$	Max.	5
			$T_j = 125\text{ °C}$	Max.	3
			$T_j = 150\text{ °C}$	Max.	5
I_{DSM}/I_{RSM}	$V_D = V_{DSM}$, $V_R = V_{RSM}$		Max.	10	

Table 3. Thermal parameters

Symbol	Parameter		Value	Unit
$R_{th(j-c)}$	Junction to case (DC, max.)	D ² PAK	0.8	°C/W
$R_{th(j-a)}$	Junction to ambient (DC, typ., $S_{cu} = 1 \text{ cm}^2$)		45	

1.1 Characteristics (curves)

Figure 1. Maximum average power dissipation versus average on-state current

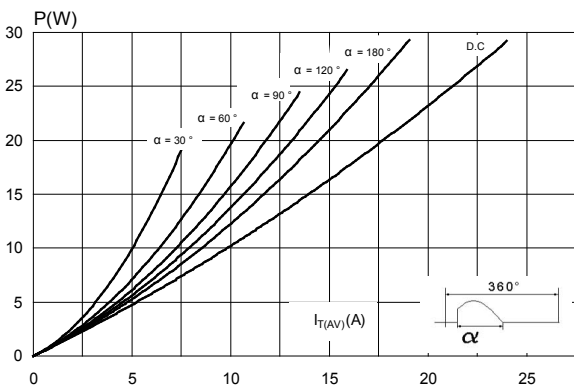

Figure 2. Average and DC on-state current versus case temperature

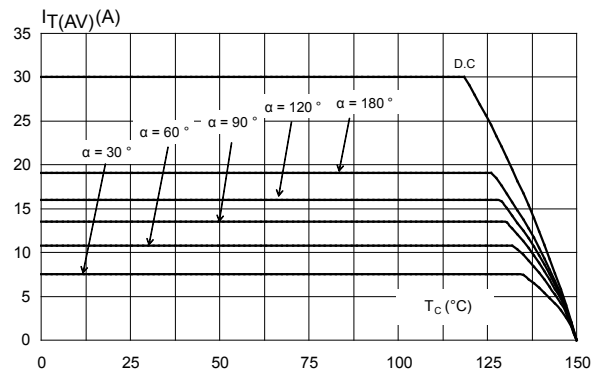

Figure 3. On-state characteristics (maximum values)

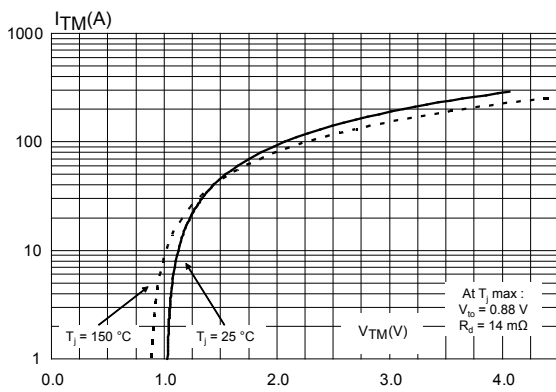

Figure 4. Average and D.C. on-state current versus ambient temperature

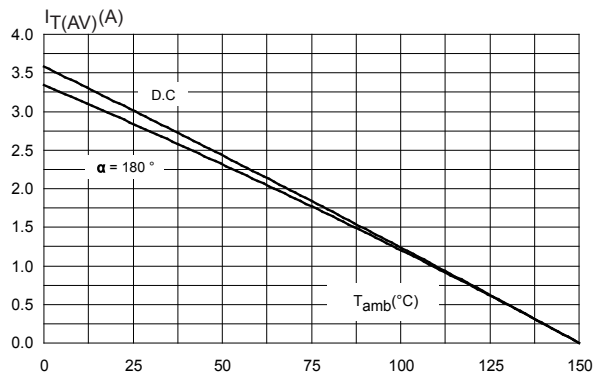

Figure 5. Relative variation of thermal impedance junction to case and junction to ambient versus pulse duration

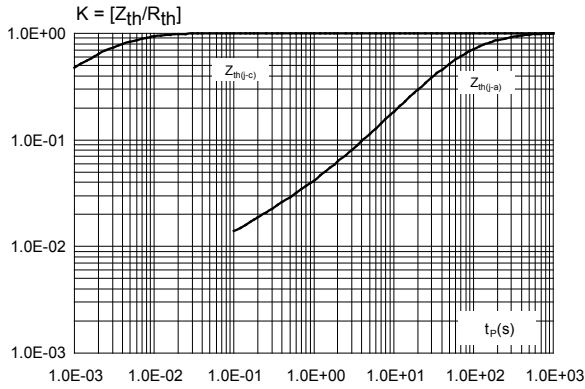

Figure 6. Thermal resistance junction to ambient versus copper surface under tab (printed circuit board FR4, copper thickness: 35 μm)

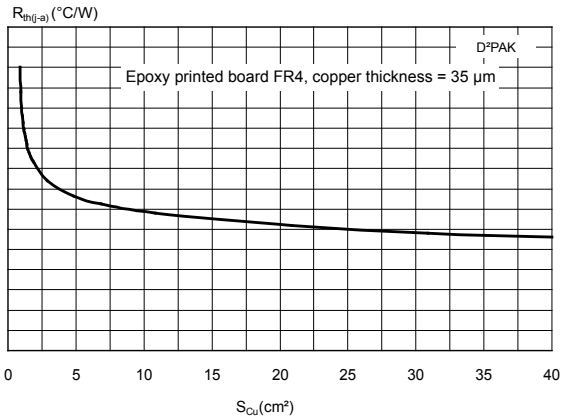

Figure 7. Surge peak on-state current versus number of cycles

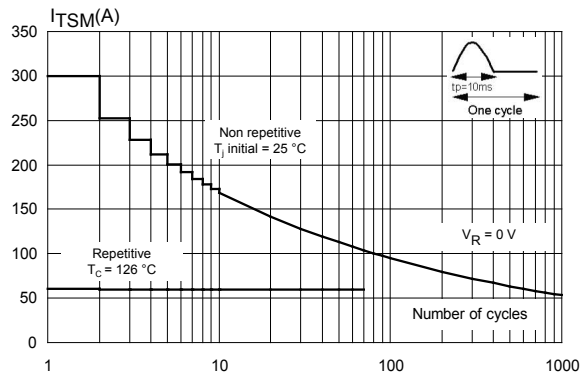

Figure 8. Non repetitive surge peak on-state current for a sinusoidal pulse (tp < 10 ms)

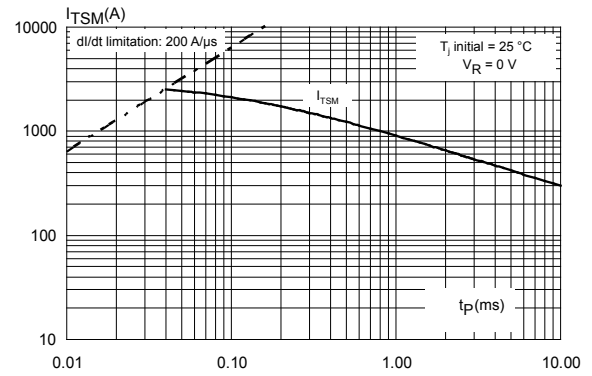

Figure 9. Relative variation of holding and latching current versus junction temperature (typical values)

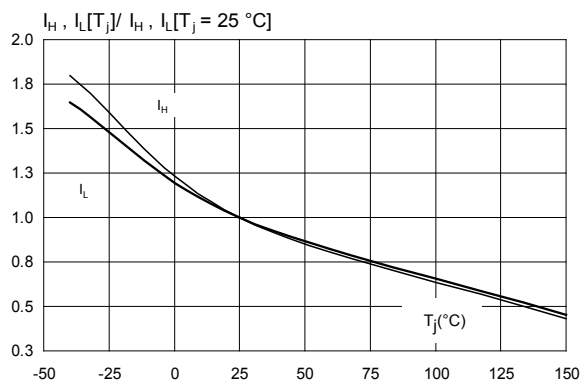

Figure 10. Relative variation of gate triggering current and voltage versus junction temperature

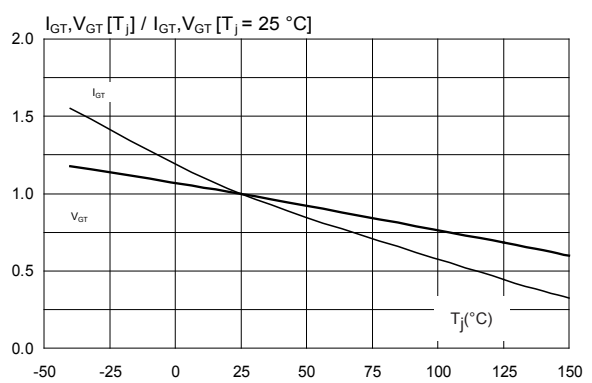

Figure 11. Relative variation of leakage current versus junction temperature for different values of blocking voltage

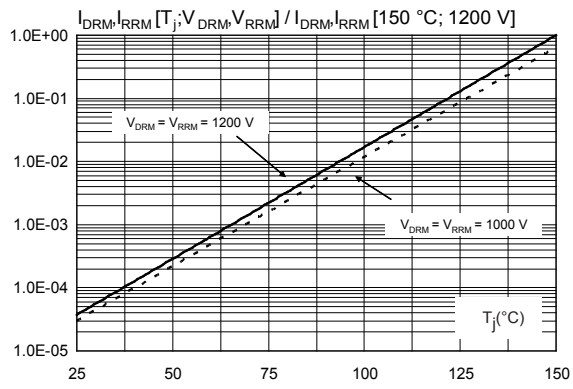
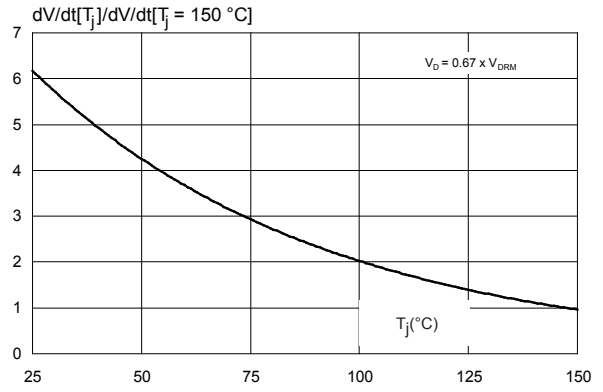

Figure 12. Relative variation of the static dV/dt immunity versus junction temperature (typical values)



2 Package information

In order to meet environmental requirements, ST offers these devices in different grades of **ECOPACK** packages, depending on their level of environmental compliance. ECOPACK specifications, grade definitions and product status are available at: www.st.com. ECOPACK is an ST trademark.

2.1 D²PAK package information

- Package molding resin is halogen free and meets UL94 level V0
- Lead-free package leads
- Cooling method: by conduction (C)

Figure 13. D²PAK package outline

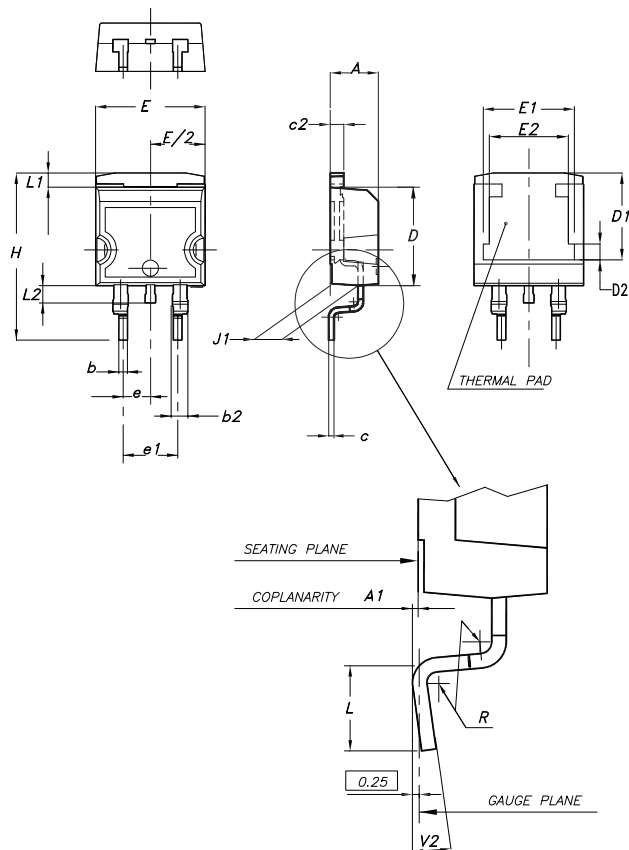
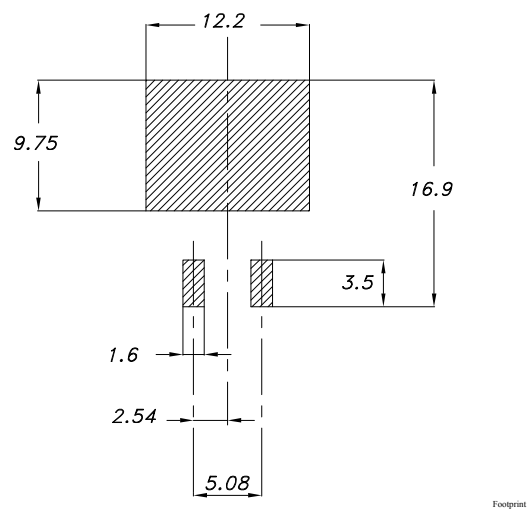

Table 4. D²PAK package mechanical data

Ref.	Dimensions					
	Millimeters			Inches ⁽¹⁾		
	Min.	Typ.	Max.	Min.	Typ.	Max.
A	4.40		4.60	0.1732		0.1811
A1	0.03		0.23	0.0012		0.0091
b	0.70		0.93	0.0276		0.0366
b2	1.14		1.70	0.0449		0.0669
c	0.45		0.60	0.0177		0.0236
c2	1.23		1.36	0.0484		0.0535
D	8.95		9.35	0.3524		0.3681
D1	7.50	7.75	8.00	0.2953	0.3051	0.3150
D2	1.10	1.30	1.50	0.0433	0.0511	0.0591
E	10		10.40	0.3937		0.4094
E1	8.50	8.70	8.90	0.3346	0.3425	0.3504
E2	6.85	7.05	7.25	0.2697	0.2776	0.2854
e		2.54			0.1000	
e1	4.88		5.28	0.1921		0.2079
H	15		15.85	0.5906		0.6240
J1	2.49		2.69	0.0980		0.1059
L	2.29		2.79	0.0902		0.1098
L1	1.27		1.40	0.0500		0.0551
L2	1.30		1.75	0.0512		0.0689
R		0.4			0.0157	
V2	0°		8°	0°		8°

1. Dimensions in inches are given for reference only

Figure 14. D²PAK recommended footprint (dimensions are in mm)

3 Ordering information

Table 5. Ordering information

Order code	Marking	Package	Weight	Base qty.	Delivery mode
TN3050H-12GY-TR	TN3050H12Y	D ² PAK	1.4 g	1000	Tape and reel

Revision history

Table 6. Document revision history

Date	Revision	Changes
01-Sep-2016	1	Initial release.
24-Aug-2017	2	Minor text changes to improve readability. Updated Section "Features", Table 2: "Absolute ratings (limiting values)" and Section 2: "Package information".
17-Sep-2019	3	Updated Section Description and Table 1. Absolute ratings (limiting values) .