

Telpower® DC Power Protection Systems Spare Fuseholders

TPSFH



Common Prefix TPSFH-

CW

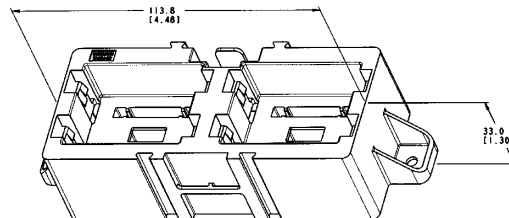

M

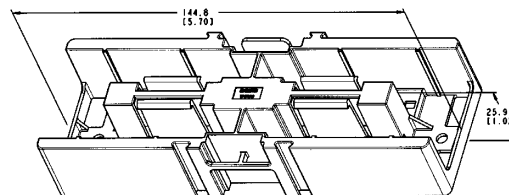

inches
mm

70

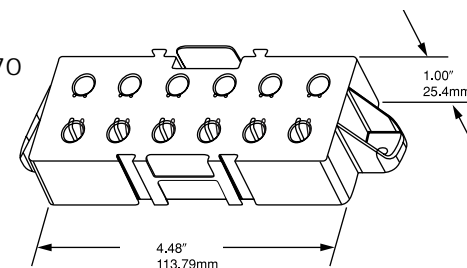

LC

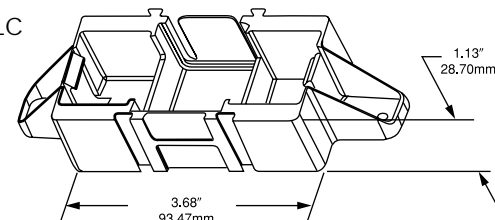

LB

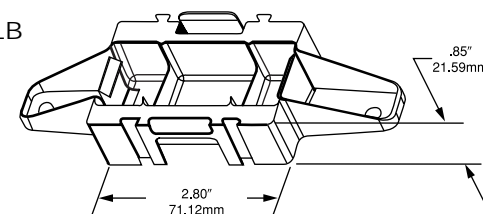

Spare Fuseholders

- Durable construction using black thermoplastic with UL 94V-0 flammability rating.
- Common mounting (.16 dia. hole) using #6 screws or bolts on 5-inch centers.
- Dovetailed interlocking between fuseholders simplifies installation and reduces needed hardware.
- Common footprint allows for any combination of fuseholders to be mounted together.
- Built-in retaining clips secure fuses.
- TPSFH-CW fuseholder holds four TPC fuses, or two TPW fuses, or two TPC fuses and one TPW fuse.

Catalog Numbers	Capacity	
TPSFH-CW	4-position	For use with TPC and / or TPWfuses
TPSFH-M	4-position	For use with TPM fuses
TPSFH-70	12-position	For use with Series 70 fuses
TPSFH-LC	1-position	For use with TPL-C series fuses
TPSFH-LB	1-position	For use with TPL-B series fuses
TPSFH-N60	1-position	For use with TPN (35-60A) fuses
TPSFH-N30	4-position	For use with TPN (1-30A) fuses
TPSFH-AS	6-position	For use with TPA & TPS fuses
TPSFH-T	10-position	For use with GMT fuses

Telpower® DC Power Protection Systems

Spare Fuseholders

TPSFH

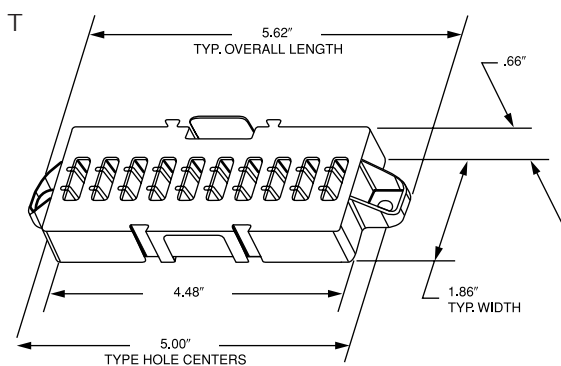
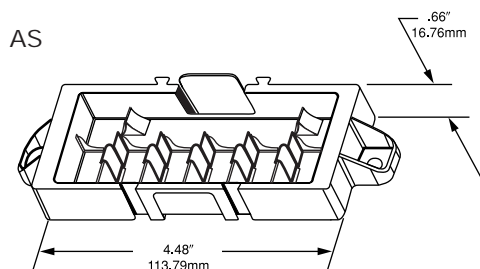
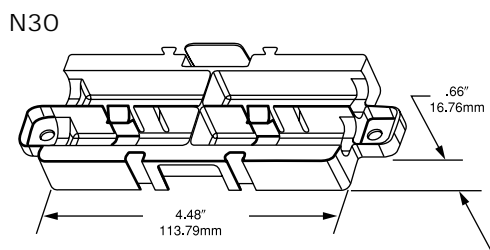
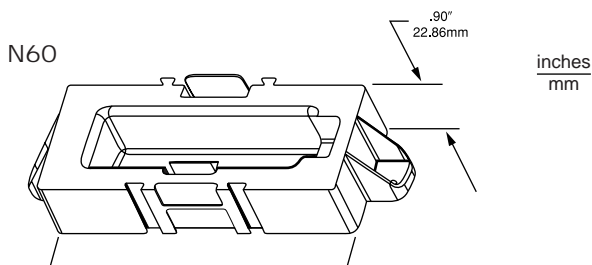

5TPH

TPA and TPA-B Fuse Spare Fuseholder

Size: 2.98" wide x 1.03" high x .63" deep

- 5-position spare fuseholder for midsize fuses ($1\frac{1}{32}$ " diameter).
- Constructed of grey thermoplastic.
- Adhesive tape on back for easy mounting on cabinet doors.

The only controlled copy of this Data Sheet is the electronic read-only version located on the Bussmann Network Drive. All other copies of this Data Sheet are by definition uncontrolled. This bulletin is intended to clearly present comprehensive product data and provide technical information that will help the end user with design applications. Bussmann reserves the right, without notice, to change design or construction of any products and to discontinue or limit distribution of any products. Bussmann also reserves the right to change or update, without notice, any technical information contained in this bulletin. Once a product has been selected, it should be tested by the user in all possible applications.