

POLYSWITCH RESETTABLE DEVICES

Telecommunications and Networking Devices

The PolySwitch families of telecommunications and networking devices help meet the growing demand for resettable overcurrent protection. These product families help provide protection against damage caused by power cross and power induction surges as defined in ITU, Telcordia GR1089 and UL60950. Available in chip, surface-mount and radial-leaded configurations, Littelfuse's PolySwitch devices help improve the reliability of customer premise and network equipment worldwide.



BENEFITS

- Choice of many product options helps engineers by improving design flexibility
- Compatible with high-volume electronics assembly
- Assist in meeting regulatory equipment requirements
- Help improve line balance
- Applicable for legacy POTS and modern digital communications equipment

FEATURES

- RoHS compliant
- Resettable overcurrent protection
- Surface-mount, radial-leaded and chip form factors
- Fast time-to-trip
- Agency recognition: UL, CSA, TÜV
- Resistance-sorted and matched devices available
- Low parasitic capacitance/flat impedance with frequency

APPLICATIONS

- Modems
- Phone sets
- Fax machines
- Phone wall outlets
- Alarm systems
- PBX systems
- MDF modules
- Analog and digital line cards
- T1/E1 equipment
- xDSL modems and splitters
- Powered ethernet systems
- VoIP (Voice over Internet Protocol) equipment
- LAN, WAN equipment
- Customer premise equipment
- Access network hardware

PolySwitch Resettable Devices

Telecommunications and Networking Devices

Application Guide for Telecommunications and Networking Devices*

To use this guide, follow the steps below:

1. Select your equipment type from the guide below.
2. Select the type of protection depending on the agency and regional specifications in the second column.
3. Select the form factor for your application.
4. Use the Agency Specification/ PolySwitch Device Selection Guide on the next page to select a specific part number for each application based on the agency requirements.
5. Parts with fast time-to-trip or low resistance are available. Please consult a Littelfuse PolySwitch representative.

Application	Region/ Specification	Overcurrent Protection		
		Form Factor		
		Radial-leaded	Surface-mount	Chip
Customer Premise equipment	North America	TRF600-150	TS600-170F	
IT equipment Analog Modems, V.90 Modems, ISDN Modems, xDSL Modems, ADSL Splitters, Phone Sets, Fax Machines, Answering Machines, Caller ID, Internet Appliances, PBX Systems, POS Terminals, Wall Plugs	TIA-968-A,	TR600-150F-EX	TS600-200F	
	UL 60950,	TRF600-160	TSM600-250F	
	GR1089 Port Type 3 [†]	TRF600-250	TSM600-400F	
		TRF-600-400		
	Europe/Asia/	TRF250-120	TS250-130F	TCF250-120
	South America	TRF250-120T	TSV250-130F	TCF250-145
	ITU K.21	TRF250-120U	TSV250-184F	TCF250-180T
		TRF250-120UT	TSL250-130F	
		TRF250-145		
		TRF250-145T		
	TRF250-145U			
	TRF250-180			
	TRF250-183			
	TRF250-183U			
	TRF250-184			
Access network equipment (†)	North America	TRF600-160	TS600-170F	
Remote Terminals, Line Repeaters, Multiplexers, Cross-Connects, WAN Equipment	GR1089 Port Type 5 [†]	TRF600-250	TS600-200F	
		TRF600-400	TS600-400F	
			TSM600-250F	
			TSM600-400F	
	Europe/Asia/	TRF250-120	TS250-130F	TCF250-120
	South America	TRF250-120T	TSV250-130F	TCF250-145
	ITU K.45	TRF250-120U	TSV250-184F	TCF250-180T
		TRF250-120UT	TSL250-130F	
		TRF250-145		
		TRF250-145T		
	TRF250-145U			
	TRF250-180			
	TRF250-183			
	TRF250-183U			
	TRF250-184			

PolySwitch Resettable Devices

Telecommunications and Networking Devices

Application Guide for Telecommunications and Networking Devices*

(Cont'd)

Application	Region/ Specification	Overcurrent Protection			
		Form Factor			
		Radial-leaded	Surface-mount	Chip	
Central office switching equipment (†) Analog/POTS Linecards, ISDN Linecards, xDSL Modems, ADSL/VDSL Splitters, T1/E1 Linecards, Multiplexers, CSU/DSU, Servers	North America GR1089 Port Type 1 [‡]	TRF600-160	TS600-170F		
		TRF600-250	TS600-200F		
		TRF600-400	TS600-400F		
				TSM600-250F	
				TSM600-400F	
		Europe/Asia/	TRF250-120	TS250-130F	TCF250-120
		South America	TRF250-120T	TSV250-130F	TCF250-145
		ITU K.20	TRF250-120U	TSV250-184F	TCF250-180T
			TRF250-120UT	TSL250-130F	
			TRF250-145		
			TRF250-145T		
			TRF250-145U		
			TRF250-180		
			TRF250-183		
			TRF250-183U		
			TRF250-184		
Primary protection modules (†) MDF modules, Network Interface Devices (NID)	North America Telcordia GR-974	TRF250-180	TSV250-184F		
		TRF250-183			
		TRF250-184			
		Europe/Asia/	TRF250-055T	TSL250-080F	TCF250-100T
		South America	TRF250-055UT	TS250-130F	TCF250-120
		ITU K.20	TRF250-080T	TSV250-130F	TCF250-120T
			TRF250-080U	TSV250-184F	TCF250-145
			TRF250-110U	TSL250-130F	TCF250-145T
			TRF250-120		TCF250-180T
			TRF250-120T		
			TRF250-120U		
			TRF250-120UT		
			TRF250-145		
			TRF250-145T		
			TRF250-145U		
			TRF250-180		
		TRF250-183			
	TRF250-183U				
	TRF250-184				

PolySwitch Resettable Devices

Telecommunications and Networking Devices

Application Guide for Telecommunications and Networking Devices*

(Cont'd)

Application	Region/ Specification	Overcurrent Protection			
		Form Factor			
		Radial-leaded	Surface-mount	Chip	
Short-haul/intrabuilding communications equipment (†) LAN Equipment, VoIP Cards, Cable Telephony NIUs, Wireless Local Loop Handsets	North America	TRF250-080T	TSL250-080F	TCF250-120	
		GR1089 Port Type 2 [‡]	TRF250-080U	TS250-130F	TCF250-145
		GR1089 Port Type 4 [‡]	TRF250-120	TSV250-130F	TCF250-180T
			TRF250-120T	TSV250-184F	
			TRF250-120U	TSL250-130F	
			TRF250-120UT		
			TRF250-145		
			TRF250-145T		
			TRF250-145U		
			TRF250-180		
		TRF250-183			
		TRF250-183U			
		TRF250-184			
		Europe/Asia/ South America	TRF250-120	TS250-130F	TCF250-120
		ITU K.21	TRF250-120T	TSV250-130F	TCF250-145
			TRF250-120U	TSV250-184F	TCF250-180T
			TRF250-120UT	TSL250-130F	
			TRF250-145		
			TRF250-145T		
			TRF250-145U		
		TRF250-180			
		TRF250-183			
		TRF250-183U			
		TSV250-184			
LAN Intrabuilding Power Cross Protection LAN Equipment, VoIP Cards, IP Phones	North America	TRF250-080T	TSL250-080F	TCF250-120	
		GR1089 Port Type 4 [‡]	TRF250-080U	TS250-130F	TCF250-145
			TRF250-120	TSV250-130F	TCF250-180T
			TRF250-120T	TSV250-184F	
			TRF250-120U	TSL250-130F	
			TRF250-120UT		
			TRF250-145		
			TRF250-145T		
			TRF250-145U		
			TRF250-180		
	TRF250-183				
	TRF250-183U				
	TRF250-184				
IEEE 802.3AF/AT Power over Ethernet protection			decaSMDC050F/60-2**		
Powered Ethernet Switches and Terminals,					
IP phones, Wireless LAN Base Stations,					
Microcellular Base Stations, VoIP Cards					

* This list is not exhaustive. Littelfuse welcomes our customers' input for additional application ideas for PolySwitch resettable devices.

† For improved line balance in these applications, resistance-matched parts are recommended.

‡ May require additional impedance or coordination with primary protector.

** For details on decaSMDC050F/60-2, please refer to surface-mount devices product brochure.

PolySwitch Resettable Devices

Telecommunications and Networking Devices

Use the guide below to select the PolySwitch devices which are typically used in your application. The following pages contain the specifications for the part numbers recommended below. PolySwitch devices assist telecommunication equipment in meeting the applicable protection requirements of these industry specifications. Refer to individual agency specifications for test procedures and circuit schematics. Users should independently evaluate the suitability of and test each product for their application.

Family	Product*	Lightning	Power Cross/Contact/Induction	
TCF250	TCF250-100T	ITU K.20 – 1.0kV 10/700µs	PRC YD/T694	
		GR-1089 Port Types 2 and 4 – 1st Level	ITU K.20/21/45 – 0.2A ² s	
			ITU K.20/21/45 – 1A ² s [†]	
			GR-1089 Port Type 4 – 120V _{AC} , 25Asc	
		TCF250-120	ITU K.20/21/45 – 1.5kV 10/700µs	ITU K.20/21/45 – 230V _{AC} , 10Ω
		TCF250-120T	ITU K.20/21/45 – 4.0kV 10/700µs [†]	ITU K.20/21/45 – 0.2A ² s
	TCF250-145	GR-1089 Port Types 2 and 4 – 1st Level	ITU K.20/21/45 – 1A ² s [†]	
	TCF250-145T		ITU K.20/21/45 – 10A ² s [†]	
	TCF250-180T		GR-1089 Port Type 4 – 120V _{AC} , 25Asc	
	TRF250	TRF250-055T	ITU K.20 – 1.0kV 10/700µs	ITU K.20 – 230V _{AC} , 10Ω
		TRF250-055UT	GR-1089 Port Types 2 and 4 – 1st Level	ITU K.20 – 0.2A ² s
TRF250-080T			ITU K.20 – 1A ² s [†]	
TRF250-080U			GR-1089 Port Type 4 – 120V _{AC} , 25Asc	
TRF250-110U		ITU K.20/21/45 – 1.5kV 10/700µs	ITU K.20/21/45 – 230V _{AC} , 10Ω	
TRF250-120		ITU K.20/21/45 – 4.0kV 10/700µs [†]	ITU K.20/21/45 – 0.2A ² s	
TRF250-120T		GR-1089 Port Types 2 and 4 – 1st Level	ITU K.20/21/45 – 1A ² s [†]	
TRF250-120U			ITU K.20/21/45 – 10A ² s [†]	
TRF250-120UT			GR-1089 Port Type 4 – 120V _{AC} , 25Asc	
TRF250-145				
TRF250-145T				
TRF250-145U				
TRF250-180				
TRF250-183				
TRF250-183U				
	TRF250-184	ITU K.20/21/45 – 1.5kV 10/700µs	ITU K.20/21/45 – 230V _{AC} , 10Ω**	
		ITU K.20/21/45 – 4.0kV 10/700µs [†]	ITU K.20/21/45 – 0.2A ² s	
		GR-1089 Port Types 2 and 4 – 1st Level	ITU K.20/21/45 – 1A ² s [†]	
			ITU K.20/21/45 – 10A ² s [†]	
			GR-1089 Port Type 4 – 120V _{AC} , 25Asc	
	TS250/TSV250	TSV250-130F	ITU K.20/21/45 – 1.5kV 10/700µs	ITU K.20/21/45 – 230V _{AC} , 10Ω
		TS250-130F	ITU K.20/21/45 – 4.0kV 10/700µs [†]	ITU K.20/21/45 – 0.2A ² s
			GR-1089 Port Types 2 and 4 – 1st Level	ITU K.20/21/45 – 1A ² s [†]
			ITU K.20/21/45 – 10A ² s [†]	
			GR-1089 Port Type 4 – 120V _{AC} , 25Asc	
	TS250-130F-RB	ITU K.20/21/45 – 1.5kV 10/700µs	ITU K.20/21/45 – 230V _{AC} , 10Ω	
		ITU K.20/21/45 – 4.0kV 10/700µs [†]	ITU K.20/21/45 – 0.2A ² s	
		GR-1089 Port Types 2 and 4 – 1st Level	ITU K.20/21/45 – 1A ² s [†]	
		ITU K.20/21/45 – 10A ² s [†]		
		GR-1089 Port Type 4 – 120V _{AC} , 25Asc		
	TSV250-184F	ITU K.20/21/45 – 1.5kV 10/700µs	ITU K.20/21/45 – 230V _{AC} , 10Ω**	
		ITU K.20/21/45 – 4.0kV 10/700µs [†]	ITU K.20/21/45 – 0.2A ² s	
		GR-1089 Port Types 2 and 4 – 1st Level	ITU K.20/21/45 – 1A ² s [†]	
			ITU K.20/21/45 – 10A ² s [†]	
		GR-1089 Port Type 4 – 120V _{AC} , 25Asc		
TSL250	TSL250-080F	GR-1089 Port Types 2 and 4 – 1st Level	GR-1089 Port Type 4 – 120V _{AC} , 25Asc	
	TSL250-130F	ITU K.20 – 1.0kV 10/700µs	ITU K.20/21/45 – 230V _{AC} , 10Ω	
			ITU K.20/21/45 – 0.2A ² s	
			ITU K.20/21/45 – 1A ² s [†]	

PolySwitch Resettable Devices

Telecommunications and Networking Devices

Agency Specification/Selection Guide

(Cont'd)

Family	Product*	Lightning	Power Cross/Contact/Induction
TRF600	TRF600-150	TIA-968-A Types A & B	UL60950 – 600V _{AC} , 40Asc
	TR600-150F-EX	GR-1089 Port Types 1, 3 and 5 – 1st and 2nd Level††	UL60950 – 600V _{AC} , 40Asc
	TRF600-160	GR-1089 Port Types 1, 3 and 5 – 1st and 2nd Level††	Telcordia GR-1089 – 600V _{AC} , 60Asc
	TRF600-250	GR-1089 Port Types 1, 3 and 5 – 1st and 2nd Level††	Telcordia GR-1089 – 600V _{AC} , 60Asc
	TRF600-400	GR-1089 Port Types 1, 3 and 5 – 1st and 2nd Level	Telcordia GR-1089 – 600V _{AC} , 60Asc
TS600	TS600-170F	TIA-968-A Types A & B	UL60950 – 600V _{AC} , 40Asc
	TS600-200F	GR-1089 Port Types 1, 3 and 5 – 1st and 2nd Level††	Telcordia GR-1089 – 600V _{AC} , 60Asc
	TS600-400F		
TSM600	TSM600-250F	TIA-968-A Types A & B	UL60950 – 600V _{AC} , 40Asc
		GR-1089 Port Types 1, 3 and 5 – 1st and 2nd Level††	Telcordia GR-1089 – 600V _{AC} , 60Asc
	TSM600-400F	TIA-968-A Types A & B	UL60950 – 600V _{AC} , 40Asc
		GR-1089 Port Types 1, 3 and 5 – 1st and 2nd Level	Telcordia GR-1089 – 600V _{AC} , 60Asc

Notes: * Applies to all products that share the same prefix. † Tested with 230V gas discharge tube primary protector. ‡ Tested with 350V gas discharge tube primary protector.

** See SCD for additional application fault ratings.

†† May require additional series resistor to help telecommunication equipment pass Surge 3 (1kV, 10/1000µs).

Table T1 – Product Series: Size, Current Rating, Voltage Rating, Typical Resistance

						TS600	
	TCF250	TRF250	TS250	TSV250	TSL250	TSM600	TRF600
V_{MAX} Interrupt (V_{AC})*	250	250	250	250	250	600	600
	ITU	ITU	ITU	ITU		UL60950	UL60950
	GR-1089	GR-1089	GR-1089	GR-1089	GR-1089	GR-1089	GR-1089
Specification	Ports 2 and 4	Ports 2 and 4	Ports 2 and 4	Ports 2 and 4	Ports 2 and 4	Ports 1, 3 and 5	Ports 1, 3 and 5
Hold Current (A)							
0.055	—	20.0Ω	—	—	—	—	—
0.080	—	17.0Ω	—	—	8.0Ω	—	—
0.100	11.0Ω	—	—	—	—	—	—
0.110	—	7.0Ω	—	—	—	—	—
0.120	10.5Ω	8.0Ω	—	—	—	—	—
0.130	—	—	9.0Ω	5.5Ω	5.5Ω	—	—
0.145	7.0Ω	4.5Ω	—	—	—	—	—
0.150	—	—	—	—	—	—	8.0Ω
0.160	—	—	—	—	—	—	6.0Ω
0.170	—	—	—	—	—	11.0Ω	—
0.183	—	1.3Ω	—	—	—	—	—
0.184	—	1.9Ω	—	1.6Ω	—	—	—
0.200	—	—	—	—	—	8.5Ω	—
0.250	—	—	—	—	—	3.5Ω	3.0Ω
0.400	—	—	—	—	—	1.2Ω	1.2Ω

Voltage Ratings for Telecommunications and Networking Devices

For circuit protection telecommunications devices there are two applicable voltage ratings. These are V_{MAX} Operating and V_{MAX} Interrupt. To help understand the nature of these two different voltage ratings, the following definitions are provided:

V_{MAX} Operating : For telecommunications devices, this is the voltage used to obtain component recognition under UL1434. Most circuit protection devices are certified at 60V but can withstand higher V_{MAX} Interrupt conditions. See Table T3 for its V_{MAX} Operating.

***V_{MAX} Interrupt** : Under specified conditions, this is the highest voltage that can be applied to the device at the maximum current. Devices may trip safely under higher power level cross conditions, as listed above, to assist equipment in meeting the appropriate industry conditions.

PolySwitch Resettable Devices

Telecommunications and Networking Devices

Table T2 – Thermal Derating [Hold Current (A) at Ambient Temperature (°C)]

Part Number**	Maximum Ambient Temperature								
	-40°C	-20°C	0°C	20°C	40°C	50°C	60°C	70°C	85°C
Chip* – 250V_{AC}									
TCF250									
TCF250-100T	0.155	0.138	0.119	0.100	0.083	0.073	0.064	0.055	0.042
TCF250-120	0.186	0.165	0.143	0.120	0.099	0.088	0.077	0.066	0.050
TCF250-120T	0.186	0.165	0.143	0.120	0.099	0.088	0.077	0.066	0.050
TCF250-145	0.225	0.199	0.172	0.145	0.119	0.106	0.093	0.080	0.060
TCF250-145T	0.225	0.199	0.172	0.145	0.119	0.106	0.093	0.080	0.060
TCF250-180T	0.269	0.240	0.211	0.180	0.153	0.138	0.123	0.109	0.087
Radial-leaded* – 250V_{AC}									
TRF250									
TRF250-055T	0.085	0.076	0.065	0.055	0.045	0.041	0.035	0.030	0.023
TRF250-055UT	0.085	0.076	0.065	0.055	0.045	0.041	0.035	0.030	0.023
TRF250-080T	0.124	0.110	0.095	0.080	0.066	0.059	0.051	0.044	0.033
TRF250-080U	0.124	0.110	0.095	0.080	0.066	0.059	0.051	0.044	0.033
TRF250-110U	0.171	0.151	0.131	0.110	0.091	0.081	0.071	0.061	0.046
TRF250-120	0.186	0.165	0.143	0.120	0.099	0.088	0.077	0.066	0.050
TRF250-120T	0.186	0.165	0.143	0.120	0.099	0.088	0.077	0.066	0.050
TRF250-120U	0.186	0.165	0.143	0.120	0.099	0.088	0.077	0.066	0.050
TRF250-120UT	0.186	0.165	0.143	0.120	0.099	0.088	0.077	0.066	0.050
TRF250-145	0.225	0.199	0.172	0.145	0.119	0.106	0.093	0.080	0.060
TRF250-145T	0.225	0.199	0.172	0.145	0.119	0.106	0.093	0.080	0.060
TRF250-145U	0.225	0.199	0.172	0.145	0.119	0.106	0.093	0.080	0.060
TRF250-180	0.279	0.247	0.213	0.180	0.147	0.131	0.115	0.099	0.074
TRF250-183 [‡]	0.284	0.251	0.217	0.183	0.149	0.133	0.117	0.101	0.075
TRF250-183U [†]	0.284	0.251	0.217	0.183	0.149	0.133	0.117	0.101	0.075
TRF250-184 [‡]	0.286	0.252	0.218	0.184	0.150	0.134	0.118	0.102	0.075
Surface-mount* – 250V_{AC}									
TS250/TSL250/TSV250									
TSL250-080F	0.124	0.110	0.095	0.080	0.066	0.059	0.051	0.044	0.033
TSL250-130F	0.208	0.182	0.156	0.130	0.104	0.091	0.078	0.065	0.045
TS250-130F	0.208	0.182	0.156	0.130	0.104	0.091	0.078	0.065	0.045
TSV250-130F	0.208	0.182	0.156	0.130	0.104	0.091	0.078	0.065	0.045
TSV250-184F	0.286	0.252	0.218	0.184	0.150	0.134	0.118	0.102	0.075
Radial-leaded[†] – 600V_{AC}									
TRF600									
TRF600-150	0.239	0.209	0.180	0.150	0.121	0.107	0.093	0.079	0.057
TR600-150F-EX	0.239	0.209	0.180	0.150	0.121	0.107	0.093	0.079	0.057
TRF600-160	0.255	0.223	0.192	0.160	0.129	0.114	0.099	0.084	0.061
TRF600-250	0.400	0.350	0.300	0.250	0.198	0.170	0.140	0.117	0.083
TRF600-400	0.640	0.560	0.480	0.400	0.320	0.270	0.230	0.190	0.130
Surface-mount[†] – 600V_{AC}									
TSM600/TSM600									
TSM600-170F	0.264	0.230	0.200	0.170	0.140	0.125	0.109	0.094	0.070
TSM600-200F	0.310	0.275	0.238	0.200	0.165	0.147	0.128	0.110	0.083
TSM600-400F	0.640	0.560	0.480	0.400	0.320	0.270	0.230	0.190	0.130
TSM600-250F	0.400	0.350	0.300	0.250	0.198	0.170	0.140	0.117	0.083
TSM600-400F	0.640	0.560	0.480	0.400	0.320	0.270	0.230	0.190	0.130

* 250V_{AC} interrupt products may help equipment pass ITU K.20, K.21 and K.45 recommendations and Telcordia GR-1089 Port Type 2 and 4 requirements.

** Applies to all products which share the same prefix.

† 600V_{AC} interrupt products may help equipment pass UL60950, TIA-968-A and GR1089 Port Type 1, 3 and 5 requirements.

‡ Product is not currently available in a resistance matched or sorted option.

PolySwitch Resettable Devices

Telecommunications and Networking Devices

Figure T1 – Thermal Derating Curve

- A = TCF250-180T
- B = All other TCF, TRF, TSM Series Devices



Table T3 – Electrical Characteristics

Part Number	I _H (A)	I _T (A)	V _{MAX}		I _{MAX} *† (A)	P _D TYP (W)	Typical Time-to-trip		R _{MIN} (Ω)	R _{MAX} (Ω)	R _{1MAX} (Ω)
			Operating (V _{DC})	Interrupt (V _{RMS})			(A)	(s)			
Chip* – 250V_{AC}											
TCF250											
TCF250-100T-RB	0.090	0.150	60	250	3.0	0.6	1.0	0.2	15.4	18.0	24.0
TCF250-120	0.120	0.240	60	250	3.0	0.8	1.0	0.9	5.0	9.0	14.0
TCF250-120T	0.120	0.240	60	250	3.0	0.8	1.0	0.6	6.3	12.0	18.0
TCF250-145	0.145	0.290	60	250	3.0	1.0	1.0	2.5	3.0	6.0	14.0
TCF250-145T	0.145	0.290	60	250	3.0	1.0	1.0	1.0	5.0	9.0	14.0
TCF250-180T†	0.180	0.380	60	250	3.0	0.8	1.0	3.4	1.9	3.0	4.2
Radial-leaded* – 250V_{AC}											
TRF250											
TRF250-055T	0.055	0.170	60	250	3.0	0.6	0.28	3.5	15.0	25.0	35.0
TRF250-055UT	0.055	0.170	60	250	3.0	0.6	0.28	3.0	15.0	25.0	35.0
TRF250-080T	0.080	0.160	60	250	3.0	0.6	0.35	4.0	15.0	22.0	33.0
TRF250-080U	0.080	0.160	60	250	3.0	0.6	0.35	2.5	14.0	20.0	33.0
TRF250-110U	0.110	0.220	60	250	3.0	0.6	1.00	0.8	5.0	9.0	16.0
TRF250-120	0.120	0.240	60	250	3.0	0.8	1.00	1.5	4.0	8.0	16.0
TRF250-120T	0.120	0.240	60	250	3.0	0.8	1.00	0.7	7.0	12.0	16.0
TRF250-120T-RA	0.120	0.240	60	250	3.0	0.8	1.00	1.2	7.0	9.0	16.0
TRF250-120T-RC	0.130	0.260	60	250	3.0	0.8	1.00	3.0	5.4	7.5	14.0
TRF250-120T-RF	0.120	0.240	60	250	3.0	0.8	1.00	0.9	6.0	10.5	16.0
TRF250-120T-RH	0.120	0.240	60	250	3.0	0.8	1.00	0.7	9.0	11.0	16.0
TRF250-120T-R1	0.120	0.240	60	250	3.0	0.8	1.00	0.7	6.0	9.0	16.0
TRF250-120T-R2	0.120	0.240	60	250	3.0	0.8	1.00	0.8	8.0	10.5	16.0
TRF250-120U	0.120	0.240	60	250	3.0	0.7	1.00	1.0	6.0	10.0	16.0
TRF250-120UT	0.120	0.240	60	250	3.0	0.7	1.00	0.7	7.0	12.0	16.0
TRF250-145	0.145	0.290	60	250	3.0	0.8	1.00	2.5	3.0	6.0	14.0

* 250V_{AC} interrupt products may help equipment pass ITU K.20, K.21 and K.45 recommendations and Telcordia GR-1089 Port Type 2 and 4 requirements.

† 600V_{AC} interrupt products may help equipment pass UL60950, TIA-968-A and GR1089 Port Type 1, 3 and 5 requirements.

‡ Product is not currently available in a resistance matched or sorted option

PolySwitch Resettable Devices

Telecommunications and Networking Devices

Table T3 – Electrical Characteristics

(Cont'd)

Part Number	I _H (A)	I _T (A)	V _{MAX}		I _{MAX} *† (A)	P _D Typ (W)	Typical Time-to-trip		R _{MIN} (Ω)	R _{MAX} (Ω)	R _{1MAX} (Ω)
			Operating (V _{DC})	Interrupt (V _{RMS})			(A)	(s)			
Radial-leaded* – 250V_{AC}											
TRF250											
TRF250-145-RA	0.145	0.290	60	250	3.0	0.8	1.00	2.5	3.0	6.0	12.0
TRF250-145T	0.145	0.290	60	250	3.0	0.8	1.00	1.5	5.4	7.5	14.0
TRF250-145U	0.145	0.290	60	250	3.0	0.7	1.00	2.0	3.5	6.5	14.0
TRF250-180	0.180	0.650	100	250	10.0	0.9	3.00	0.5	0.8	2.2	4.0
TRF250-183‡	0.183	0.685	100	250	10.0	0.9	3.00	0.6	0.8	2.0	3.4
TRF250-183U‡	0.183	0.685	100	250	10.0	0.9	3.00	0.6	0.8	2.0	3.4
TRF250-184‡	0.184	1.000	100	250	10.0	0.9	3.00	0.5	1.2	2.4	3.1
Surface-mount* – 250V_{AC}											
TS250/TSL250/TSV250											
TSL250-080F	0.080	0.240	80	250	3.0	1.2	1.0	0.8	5.0	11.0	20.0**
TSL250-130F	0.130	0.260	60	250	3.0	1.5	1.0	2.0	4.0	8.0	12.0**
TS250-130F	0.130	0.260	60	250	3.0	1.1	1.0	0.9	6.5	12.0	20.0**
	—	—	60	600	1.0	—	—	—	—	—	—
TS250-130F-RA	0.130	0.260	60	250	3.0	1.1	1.0	1.4	6.5	9.0	15.0**
	—	—	60	600	1.0	—	—	—	—	—	—
TS250-130F-RB	0.130	0.260	60	250	3.0	1.1	1.0	0.7	9.0	12.0	20.0**
	—	—	60	600	1.0	—	—	—	—	—	—
TS250-130F-RC	0.130	0.260	60	250	3.0	1.1	1.0	1.1	7.0	10.0	17.0**
	—	—	60	600	1.0	—	—	—	—	—	—
TSV250-130F	0.130	0.260	60	250	3.0	1.5	1.0	2.0	4.0	7.0	12.0**
TSV250-184F	0.184	0.690	100	250	10.0	0.9	3.0	0.5	1.2	3.0	4.0**
Radial-leaded† – 600V_{AC}											
TRF600											
TRF600-150	0.150	0.300	250	600	3.0	1.4	1.0	1.4	6.0	10.0	17.0
TRF600-150-RB	0.150	0.300	250	600	3.0	1.4	1.0	1.0	9.0	12.0	22.0
TRF600-150-R2	0.150	0.300	250	600	3.0	1.4	1.0	1.3	7.0	10.0	17.0
TR600-150FEX	0.150	0.300	250	600	3.0	1.4	1.0	5.0	6.0	12.0	22.0
TR600-150FEX-RB	0.150	0.300	250	600	3.0	1.4	1.0	5.0	9.0	12.0	22.0
TRF600-160	0.160	0.320	250	600	3.0	1.7	1.0	7.5	4.0	10.0	18.0
TRF600-160-RA	0.160	0.320	250	600	3.0	1.7	1.0	9.5	4.0	7.0	16.0
TRF600-250	0.250	0.850	250	600	3.0	2.0	3.0	1.0	1.0	4.3	7.0
TRF600-400	0.400	1.000	60	600	3.0	2.4	3.0	4.0	0.95	1.45	1.90
Surface-mount† – 600V_{AC}											
TS600/TSM600											
TS600-170F	0.170	0.400	60	600	3.0	2.5	1.0	10.0	4.0	9.0	18.0
TS600-200F-RA-B-0.5	0.200	0.400	60	600	3.0	2.5	1.0	12.0	4.0	7.5	13.5
TS600-400F	0.400	1.000	60	600	3.0	2.0	3.0	5.0	0.5	1.1	2.0
TSM600-250F	0.250	0.860	250	600	3.0	2.0	3.0	0.8	1.0	3.5	7.0
TSM600-250F-RA	0.250	0.860	250	600	3.0	2.0	3.0	1.0	1.0	3.0	5.0
TSM600-400F	0.400	1.000	250	600	3.0	2.0	3.0	5.0	0.5	1.1	2.0

Notes:

- I_H : Hold current; maximum current device will pass without interruption in 20°C still air.
- I_T : Trip current; minimum current that will switch the device from low resistance to high resistance in 20°C still air.
- V_{MAX} Operating : Maximum continuous voltage device can withstand without damage at rated current. This voltage is used for component recognition under UL1434.
- V_{MAX} Interrupt : Maximum voltage that can be safely placed across a device in its tripped state. Devices may trip safely under higher level power cross conditions to assist equipment in meeting
- I_{MAX} Interrupt : Maximum fault current device can withstand without damage at rated operating voltage. This current is used for component recognition under UL1434.
- Devices may trip safely under higher level power cross conditions to assist equipment in meeting the appropriate ITU, UL60950 or GR1089 industry requirements.
- P_D : Power dissipated from device when in the tripped state in 20°C still air.
- R_{MIN} : Minimum resistance of device as supplied at 20°C unless otherwise specified.
- R_{MAX} : Maximum resistance of device as supplied at 20°C unless otherwise specified.
- R_{1MAX} : Maximum resistance measured one hour post-trip or post-reflow at 20°C.

* 250V_{AC} interrupt products may help equipment pass ITU K.20, K.21 and K.45 recommendations and Telcordia GR-1089 Port Type 2 and 4 requirements.

† 600V_{AC} interrupt products may help equipment pass UL60950, TIA-968-A and GR1089 Port Type 1, 3 and 5 requirements.

‡ Product is not currently available in a resistance matched or sorted option.

** R_{1MAX} measured 1 hour post-trip or 24 hours post-reflow at 20°C.

PolySwitch Resettable Devices

Telecommunications and Networking Devices

Figures T2-T12 – Dimension Figures



PolySwitch Resettable Devices

Telecommunications and Networking Devices

Table T4 — Dimensions & Weights

Part Number**	Dimensions in Millimeters (Inches)														Figure	Device Mass (g) (Only for Reference)
	A		B		C		D		E		F		G			
	Min	Max	Min	Max	Min	Max	Min	Max	Min	Max	Min	Max	Min	Max		
TCF-250V*																
TCF250-100T	4.6 (0.18)	4.9 (0.19)	4.6 (0.18)	4.9 (0.19)	2.0 (0.08)	2.3 (0.09)	—	—	—	—	—	—	—	—	T4	0.24
TCF250-120	5.4 (0.21)	5.6 (0.22)	5.4 (0.21)	5.6 (0.22)	2.0 (0.08)	2.3 (0.09)	—	—	—	—	—	—	—	—	T4	0.28
TCF250-120T	5.4 (0.21)	5.6 (0.22)	5.4 (0.21)	5.6 (0.22)	2.0 (0.08)	2.3 (0.09)	—	—	—	—	—	—	—	—	T4	0.28
TCF250-145	5.4 (0.21)	5.6 (0.22)	5.4 (0.21)	5.6 (0.22)	2.0 (0.08)	2.5 (0.10)	—	—	—	—	—	—	—	—	T4	0.28
TCF250-145T	5.4 (0.21)	5.6 (0.22)	5.4 (0.21)	5.6 (0.22)	2.0 (0.08)	2.5 (0.10)	—	—	—	—	—	—	—	—	T4	0.28
TCF250-180T	6.9 (0.27)	7.1 (0.28)	6.9 (0.27)	7.1 (0.28)	1.3 (0.05)	1.6 (0.06)	—	—	—	—	—	—	—	—	T4	0.35
TRF250-250V*																
TRF250-055T	—	5.8 (0.23)	—	9.9 (0.39)	—	4.6 (0.18)	4.7 (0.19)	—	5.0 [†] (0.20)	—	—	—	—	—	T2	0.28
TRF250-055UT	—	4.8 (0.19)	—	9.3 (0.37)	—	3.8 (0.15)	4.7 (0.19)	—	5.0 [†] (0.20)	—	—	—	—	—	T11	0.13
TRF250-080T	—	5.8 (0.23)	—	9.9 (0.39)	—	4.6 (0.18)	4.7 (0.19)	—	5.0 [†] (0.20)	—	—	—	—	—	T2	0.28
TRF250-080U	—	4.8 (0.19)	—	9.3 (0.37)	—	3.8 (0.15)	4.7 (0.19)	—	5.0 [†] (0.20)	—	—	—	—	—	T11	0.13
TRF250-110U	—	5.3 (0.21)	—	9.4 (0.37)	—	3.8 (0.15)	4.7 (0.19)	—	5.0 [†] (0.20)	—	—	—	—	—	T11	0.13
TRF250-120	—	6.5 (0.26)	—	11.0 (0.43)	—	4.6 (0.18)	4.7 (0.19)	—	5.0 [†] (0.20)	—	—	—	—	—	T3	0.38
TRF250-120T	—	6.5 (0.26)	—	11.0 (0.43)	—	4.6 (0.18)	4.7 (0.19)	—	5.0 [†] (0.20)	—	—	7.0 (0.28)	—	—	T3	0.38
TRF250-120U	—	6.0 (0.24)	—	10.0 (0.39)	—	3.8 (0.15)	4.7 (0.19)	—	5.0 [†] (0.20)	—	—	6.0 (0.24)	—	—	T10	0.19
TRF250-120UT	—	6.0 (0.24)	—	10.0 (0.39)	—	3.8 (0.15)	4.7 (0.19)	—	5.0 [†] (0.20)	—	—	6.0 (0.24)	—	—	T10	0.19
TRF250-145	—	6.5 (0.26)	—	11.0 (0.43)	—	4.6 (0.18)	4.7 (0.19)	—	5.0 [†] (0.20)	—	—	7.0 (0.28)	—	—	T3	0.38
TRF250-145T	—	6.5 (0.26)	—	11.0 (0.43)	—	4.6 (0.18)	4.7 (0.19)	—	5.0 [†] (0.20)	—	—	7.0 (0.28)	—	—	T3	0.38
TRF250-145U	—	6.0 (0.24)	—	10.0 (0.39)	—	3.8 (0.15)	4.7 (0.19)	—	5.0 [†] (0.20)	—	—	6.0 (0.24)	—	—	T10	0.19
TRF250-180	—	9.0 (0.35)	—	12.0 (0.47)	—	3.8 (0.15)	4.7 (0.19)	—	5.0 [†] (0.20)	—	—	—	—	—	T2	0.35
TRF250-183	—	7.5 (0.29)	—	10.5 (0.41)	—	3.8 (0.15)	4.7 (0.19)	—	5.0 [†] (0.20)	—	—	—	—	—	T2	0.30
TRF250-183U	—	6.5 (0.26)	—	10.0 (0.39)	—	3.0 (0.12)	4.7 (0.19)	—	5.0 [†] (0.20)	—	—	—	—	—	T11	0.16
TRF250-184	—	7.7 (0.30)	—	10.5 (0.41)	—	4.6 (0.18)	4.7 (0.19)	—	5.0 [†] (0.20)	—	—	—	—	—	T2	0.32
TS250/TSL250/TSV250-250V*																
TSL250-080F	6.7 (0.27)	7.9 (0.31)	2.7 (0.11)	3.7 (0.15)	4.8 (0.19)	5.3 (0.21)	0.2 (0.01)	0.4 (0.02)	2.5 (0.10)	3.1 (0.12)	—	—	—	—	T7	2.80
TSL250-130F	6.7 (0.27)	7.9 (0.31)	2.7 (0.11)	3.7 (0.15)	4.8 (0.19)	5.3 (0.21)	0.2 (0.01)	0.4 (0.02)	2.5 (0.10)	3.1 (0.12)	—	—	—	—	T7	2.80

PolySwitch Resettable Devices

Telecommunications and Networking Devices

Table T4 – Dimensions & Weights

(Cont'd)

Part Number**	Dimensions in Millimeters (Inches)														Figure	Device Mass (g) (Only for Reference)
	A		B		C		D		E		F		G			
	Min	Max	Min	Max	Min	Max	Min	Max	Min	Max	Min	Max	Min	Max		
TS250-130F	8.5 (0.34)	9.4 (0.37)	—	3.4 (0.14)	—	7.4 (0.29)	0.3 [†] (0.01)	—	3.8 [†] (0.15)	—	—	—	—	—	T5	3.60
TS250/TSL250/TSV250-250V*																
TSV250-130F	—	6.10 (0.24)	—	6.90 (0.27)	—	3.20 (0.13)	0.56 (0.02)	—	—	1.90 (0.08)	1.60 (0.07)	2.30 (0.09)	—	—	T6	2.80
TSV250-184F	—	6.10 (0.24)	—	6.90 (0.27)	—	3.20 (0.13)	0.56 (0.02)	—	—	1.90 (0.08)	1.60 (0.07)	2.30 (0.09)	—	—	T6	2.80
TRF600-600V[†]																
TRF600-150	—	9.0 (0.35)	—	12.5 (0.49)	—	4.6 (0.18)	4.7 (0.19)	—	5.0 (0.20)	—	—	9.0 (0.35)	—	—	T3	0.37
TR600-150F-EX	—	13.5 (0.53)	—	12.6 (0.50)	—	6.0 (0.18)	4.7 (0.19)	—	5.0 (0.20)	—	—	—	—	—	T12	0.80
TRF600-160	—	16.0 (0.63)	—	12.6 (0.50)	—	6.0 (0.24)	4.7 (0.19)	—	5.0 [‡] (0.20)	—	—	10.0 (0.39)	—	—	T13	0.90
TRF600-250	—	15.0 (0.59)	—	14.5 (0.57)	—	4.6 (0.18)	4.7 (0.19)	—	5.0 [‡] (0.20)	—	—	10.0 (0.39)	—	—	T3	0.87
TRF600-400	—	14.8 (0.58)	—	13.1 (0.52)	—	4.6 (0.18)	6.0 (0.27)	—	5.0 [‡] (0.20)	—	—	—	—	—	T12	0.85
TS600/TSM600-600V[†]																
TS600-170F	18.3 (0.72)	19.4 (0.77)	11.6 (0.46)	12.3 (0.49)	7.2 (0.29)	8.3 (0.33)	1.7 (0.07)	2.4 (0.10)	9.9 (0.39)	10.4 (0.41)	1.5 (0.06)	2.3 (0.09)	—	—	T8	23.6
TS600-200F	18.3 (0.72)	19.4 (0.77)	11.6 (0.46)	12.3 (0.49)	7.2 (0.29)	8.3 (0.33)	1.7 (0.07)	2.4 (0.10)	9.9 (0.39)	10.4 (0.41)	1.5 (0.06)	2.3 (0.09)	—	—	T8	23.6
TS600-400F	18.3 (0.72)	19.4 (0.77)	11.6 (0.46)	12.3 (0.49)	7.2 (0.29)	8.3 (0.33)	1.7 (0.07)	2.4 (0.10)	9.9 (0.39)	10.4 (0.41)	1.5 (0.06)	2.3 (0.09)	—	—	T8	19.8
TSM600-250F	17.0 (0.67)	17.60 (0.69)	11.20 (0.44)	11.70 (0.46)	10.40 (0.41)	11.20 (0.44)	4.80 (0.19)	5.20 (0.20)	2.50 (0.10)	2.80 (0.11)	0.60 (0.02)	1.0 (0.04)	2.2 (0.09)	3.1 (0.12)	T9	31.2
TSM600-400F	17.0 (0.67)	17.60 (0.69)	11.20 (0.44)	11.70 (0.46)	10.40 (0.41)	11.20 (0.44)	4.80 (0.19)	5.20 (0.20)	2.50 (0.10)	2.80 (0.11)	0.60 (0.02)	1.0 (0.04)	2.2 (0.09)	3.1 (0.12)	T9	31.2

* 250V_{AC} interrupt products may help equipment pass ITU K.20, K.21 and K.45 recommendations and Telcordia GR-1089 Port Type 2 and 4 requirements.

** Applies to all products which share the same prefix.

† 600V_{AC} interrupt products may help equipment pass UL60950, TIA-968-A and GR1089 Port Type 1, 3 and 5 requirements.

‡ Indicates dimension is typical, not minimum.

Figures T13-T16 – Typical Time-to-Trip Curves at 20°C

TCF250

A = TCF250-180T

B = TCF250-145/145T

C = TCF250-120/120T

D = TCF250-100T

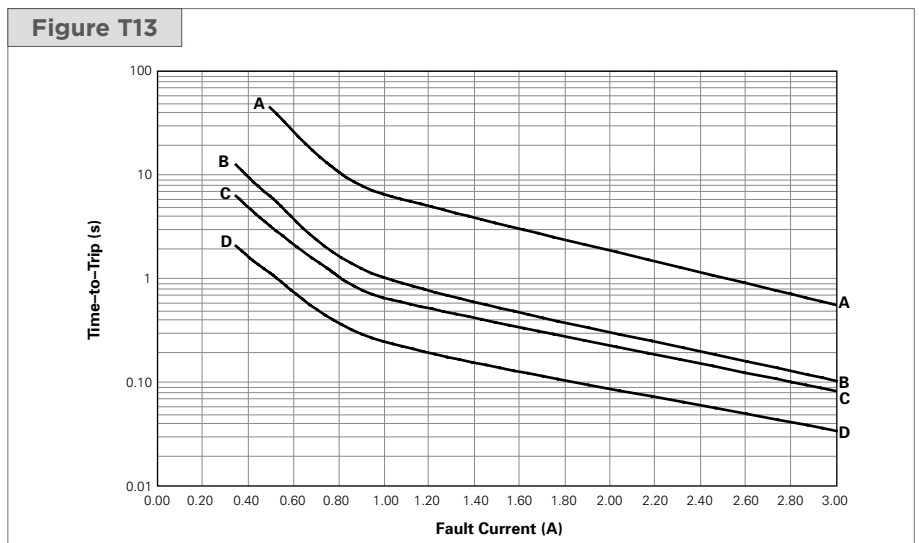

PolySwitch Resettable Devices

Telecommunications and Networking Devices

Figures T13-T16 — Typical Time-to-Trip Curves at 20°C

(Cont'd)

TRF250

- A = TRF250-180/183/183U/184
- B = TRF250-145/145U/145T
- C = TRF250-120/120U
- D = TRF250-110U/120UT/120T
- E = TRF250-080T/080U
- F = TRF250-055T/055U

Figure T14

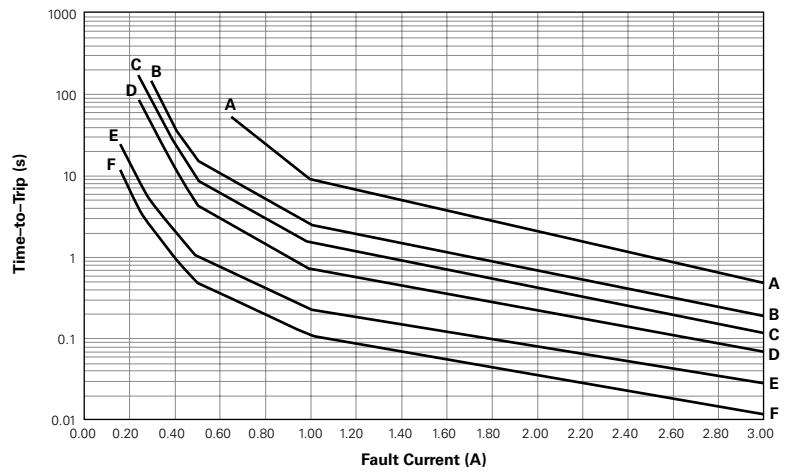

TS250/TSV250/TSL250

- A = TSV250-184F
- B = TSV250-130F/TSL250-130F
- C = TS250-130F
- D = TSL250-080F

Figure T15

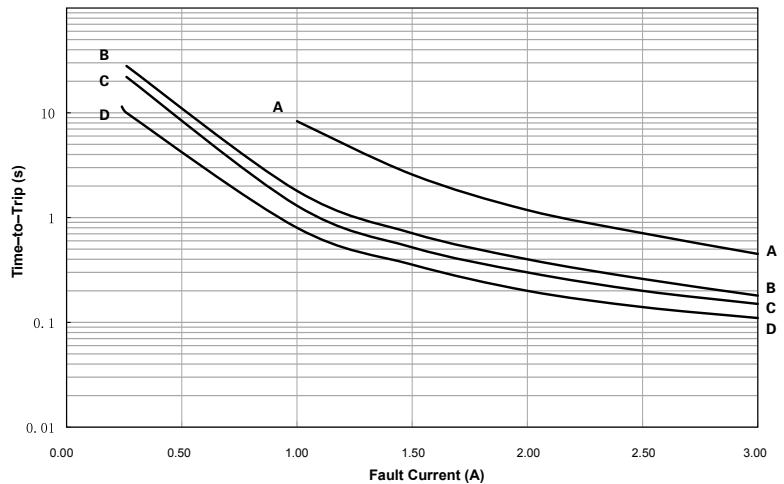

TRF600/TS600/TSM600

- A = TRF600-400/TS600-400/
TSM600-400F
- B = TRF600-250/TSM600-250F/
TS600-170F/200F
- C = TRF600-160
- D = TR600-150F-EX
- E = TRF600-150

Figure T16

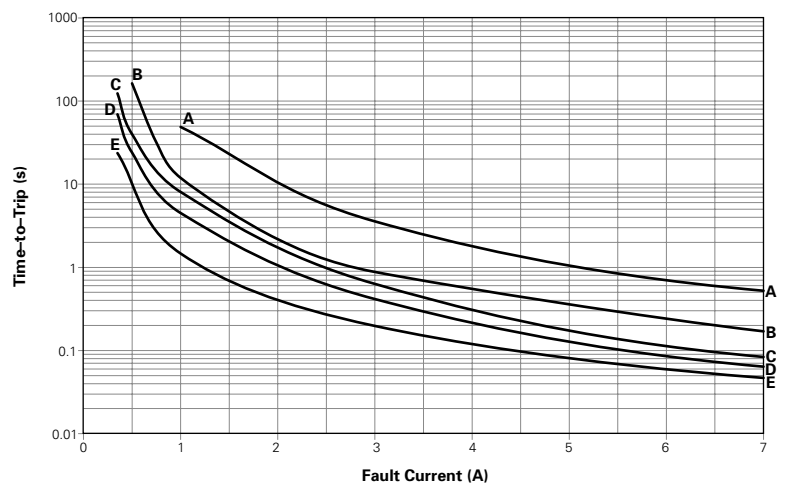

PolySwitch Resettable Devices

Telecommunications and Networking Devices

Table T5 – Physical Characteristics and Environmental Specifications

Operating temperature range for all listed products is -40°C to 85°C, except for TRF250-080T and TRF250-184 (0°C to 85°C)

TCF250*	
Physical Characteristics	
Terminal Material	Nickel-plated Copper Foil
Environmental Specifications	
Test	Conditions
Passive Aging	60°C, 1000 hrs
	85°C, 1000 hrs
Humidity Aging	85°C, 85% RH, 1000 hrs
Thermal Shock	125°C, -55°C (10 Times)
Solvent Resistance	MIL-STD-202, Method 215F

Note: Storage conditions: 40°C (max), 70% RH (max), devices should remain in original sealed bag prior to use. Devices may not meet specified values if these storage conditions are exceeded.

TRF250*	
Physical Characteristics	
Lead Material	Tin-plated Copper, 22AWG
Insulating Material	Cured Epoxy Polymer
Flammability	Per IEC 695-2-2 Needle Flame Test for 20 s
Soldering Characteristics	ANSI/J-STD-002, Category 3
Solder Heat Withstand	IEC-STD 68-2-20, Test Tb, Section 5 Method 1A, Condition B: Can Withstand 10s at 260°C±5°C

Note: Devices are not intended to be placed through a reflow process.

Environmental Specifications	
Test	Conditions
Passive Aging	60°C, 1000 hrs
	85°C, 1000 hrs
Humidity Aging	85°C, 85% RH, 1000 hrs
Thermal Shock	125°C, -55°C (10 Times)
Solvent Resistance	MIL-STD-202, Method 215F

Note: Storage conditions: 40°C (max), 70% RH (max), devices should remain in original sealed bag prior to use. Devices may not meet specified values if these storage conditions are exceeded.

TS250/TSV250/TSL250*	
Physical Characteristics	
Terminal Material	Tin-plated Brass, Nickel Under-plating
Soldering Characteristics	EIC 60068-2-58
Environmental Specifications	
Test	Conditions
Passive Aging	60°C, 1000 hrs
	85°C, 1000 hrs
Humidity Aging	85°C, 85% RH, 500 hrs
Thermal Shock	125°C, -55°C (10 Times)
Solvent Resistance	MIL-STD-202, Method 215F

Note: Storage conditions: 40°C (max), 70% RH (max), devices should remain in original sealed bag prior to use. Devices may not meet specified values if these storage conditions are exceeded.

PolySwitch Resettable Devices

Telecommunications and Networking Devices

Table T5 — Physical Characteristics and Environmental Specifications

(Cont'd)

Operating temperature range for all listed products is -40°C to 85°C, except for TRF250-080T and TRF250-184 (0°C to 85°C)

TRF600 [†]	
Physical Characteristics	
Lead Material	Tin-plated Copper, 22AWG
Insulating Material	Cured Epoxy Polymer [†]
Flammability	Per IEC 695-2-2 Needle Flame Test for 20s
Soldering Characteristics	ANSI/J-STD-002, Category 3
Solder Heat Withstand	IEC-STD 68-2-20, Test Tb, Section 5 Method 1A, Condition B: Can Withstand 10 s at 260°C±5°C

Note: Devices are not intended to be placed through a reflow process.

Environmental Specifications	
Test	Conditions
Passive Aging	60°C, 1000 hrs
	85°C, 1000 hrs
Humidity Aging	85°C, 85% RH, 1000 hrs [†]
Thermal Shock	125°C, -55°C (10 Times)
Solvent Resistance	MIL-STD-202, Method 215F

Note: Storage conditions: 40°C (max), 70% RH (max) devices should remain in original sealed bag prior to use.

Devices may not meet specified values if these storage conditions are exceeded.

TS600 [†]	
Physical Characteristics	
Terminal Material	Tin-plated Brass
Insulating Material	Nylon Resin (UL94V-0), 1000V Dielectric Rating
Flammability	IEC 695-2-2 Needle Flame Test for 20 s
Soldering Characteristics	ANSI/J-STD-002, Category 3
Solder Heat Withstand	IEC-STD 68-2-20, Test Tb, Section 5 Method 1A

Environmental Specifications	
Test	Conditions
Passive Aging	60°C, 1000 hrs
	85°C, 1000 hrs
Humidity Aging	85°C, 85% RH, 1000 hrs
Thermal Shock	125°C, -55°C (10 Times)
Solvent Resistance	MIL-STD-202, Method 215F

Note: Storage conditions: 40°C (max), 70% RH (max), devices should remain in original sealed bag prior to use.

Devices may not meet specified values if these storage conditions are exceeded.

* 250V_{AC} interrupt products may help equipment pass ITU K.20, K.21 and K.45 recommendations and Telcordia GR-1089 Port Type 2 and 4 requirements.

† 600V_{AC} interrupt products may help equipment pass UL60950, TIA-968-A and GR1089 Port Type 1, 3 and 5 requirements.

‡ Excluding TRF600-150 and TRF600-400, which have a coating that is not rated for dielectric withstand and can withstand 500h at 85°C/85% RH or 1000h at 60°C/90% RH.

PolySwitch Resettable Devices

Telecommunications and Networking Devices

Table T5 — Physical Characteristics and Environmental Specifications

(Cont'd)

Operating temperature range for all listed products is -40°C to 85°C, except for TRF250-080T and TRF250-184 (0°C to 85°C)

TSM600[†]	
Physical Characteristics	
Terminal Material	Tin-plated Brass
Insulating Material	Nylon Resin (UL94V-0), 1000V Dielectric Rating
Flammability	IEC 695-2-2 Needle Flame Test for 20 s
Soldering Characteristics	EIC60068-2-58, Method 7
Solder Heat Withstand	IEC-STD 68-2-20, Test Tb, Section 5 Method 1A
Environmental Specifications	
Test	Conditions
Passive Aging	60°C, 1000 hrs
	85°C, 1000 hrs
Humidity Aging	85°C, 85% RH, 1000 hrs
Storage Humidity	Per IPC/JEDEC J-STD-020A Level 2a
Thermal Shock	125°C, -55°C (10 Times)
Solvent Resistance	MIL-STD-202, Method 215J

Note: Storage conditions: 40°C (max), 70% RH (max) devices should remain in original sealed bag prior to use. Devices may not meet specified values if these storage conditions are exceeded.

† 600V_{AC} interrupt products may help equipment pass UL60950, TIA-968-A and GR1089 Port Type 1, 3 and 5 requirements.

Table T6 — Packaging and Marking Information

Part Number**	Bag Quantity	Tape and Reel Quantity	Standard Package Quantity	Part Marking	Agency Recognition
Chip* — 250V_{AC}					
TCF250					
TCF250-100T	2,500	—	10,000	—	—
TCF250-120	2,500	—	10,000	—	—
TCF250-120T	2,500	—	10,000	—	—
TCF250-145	2,500	—	10,000	—	UL
TCF250-145T	2,500	—	10,000	—	UL
TCF250-180T	2,500	—	10,000	—	UL
Radial-leaded* — 250V_{AC}					
TRF250					
TRF250-055T	500	—	10,000	—	—
TRF250-055UT	500	—	10,000	—	—
TRF250-080U	500	—	10,000	—	UL, CSA, TÜV
TRF250-080T	500	—	10,000	08F	UL, CSA, TÜV
TRF250-110U	500	—	10,000	—	UL, CSA, TÜV
TRF250-120	500	—	10,000	20F	UL, CSA, TÜV
TRF250-120-2	—	1,500	7,500	20F	UL, CSA, TÜV
TRF250-120T	500	—	10,000	20F	UL, CSA, TÜV
TRF250-120T-2	—	1,500	7,500	20F	UL, CSA, TÜV
TRF250-120U	500	—	10,000	20F	UL, CSA, TÜV
TRF250-120U-2	—	1,500	7,500	20F	UL, CSA, TÜV
TRF250-120UT	500	—	10,000	20F	UL, CSA, TÜV

PolySwitch Resettable Devices

Telecommunications and Networking Devices

Table T6 – Packaging and Marking Information

(Cont'd)

Part Number**	Bag Quantity	Tape and Reel Quantity	Standard Package Quantity	Part Marking	Agency Recognition
Radial-leaded* – 250V_{AC}					
TRF250					
TRF250-145	500	—	10,000	45F	UL, CSA, TÜV
TRF250-145-2	—	1,500	7,500	45F	UL, CSA, TÜV
TRF250-145T	500	—	10,000	45F	UL, CSA, TÜV
TRF250-145T-2	—	1,500	7,500	45F	UL, CSA, TÜV
TRF250-145U	500	—	10,000	45F	UL, CSA, TÜV
TRF250-145U-2	—	1,500	7,500	45F	UL, CSA, TÜV
TRF250-180	500	—	10,000	80F	UL, CSA, TÜV
TRF250-180-2	—	1500	7,500	80F	UL, CSA, TÜV
TRF250-183	500	—	10,000	83F	UL, CSA, TÜV
TRF250-183-2	—	1,500	7,500	83F	UL, CSA, TÜV
TRF250-183U	500	—	10,000	—	UL, CSA, TÜV
TRF250-184	500	—	10,000	84F	UL, CSA, TÜV
Surface-mount* – 250V_{AC}					
TS250/TSL250/TSV250					
TSL250-080F-2	—	1,500	7,500	T08	UL, CSA, TÜV
TSL250-130F-2	—	1,500	7,500	T13	—
TS250-130F-2	—	1,500	7,500	T13	UL, CSA, TÜV
TSV250-130F	2500	—	10,000	T13V	UL, CSA, TÜV
TSV250-130F-2	—	1,200	6,000	T13V	UL, CSA, TÜV
TSV250-184F	2500	—	10,000	T18V	UL
Radial-leaded† – 600V_{AC}					
TRF600					
TRF600-150	500	—	10,000	150F	UL, CSA, TÜV
TRF600-150-2	—	1,500	7,500	150F	UL, CSA, TÜV
TR600-150F-EX	500	—	10,000	150F	UL, CSA
TR600-150F-EX-2	—	600	3,000	150F	UL, CSA
TRF600-160	500	—	10,000	160F	UL, CSA, TÜV
TRF600-160-2	—	600	3,000	160F	UL, CSA, TÜV
TRF600-250	500	—	10,000	250F	UL, CSA, TÜV
TRF600-400	500	—	10,000	400F	UL, CSA, TÜV
Surface-mount† – 600V_{AC}					
TS600/TSM600					
TS600-170F-2	—	300	900	T20	UL, CSA
TS600-200F-RA-2	—	300	900	T20	UL, CSA
TS600-400F-2	—	300	900	T40	UL, CSA
TSM600-250F-2	—	200	600	TSM600	UL, CSA
TSM600-250F-RA-2	—	200	600	TSM600	UL, CSA
TSM600-400F-2	—	200	600	TSM600-4	UL

Notes:

* 250V_{AC} interrupt products are designed to help equipment pass ITU K.20, K.21 and K.45 recommendations and Telcordia GR-1089 Port Type 2 and 4 requirements.

** Applies to all products which share the same prefix.

† 600V_{AC} interrupt products are designed to help equipment pass UL60950, TIA-968-A and GR1089 Port Type 1, 3 and 5 requirements.

Agency Recognition

UL File # E74889

CSA File # 78165C

TÜV Per IEC60730-1 Certificate # for individual products available upon request.

PolySwitch Resettable Devices

Telecommunications and Networking Devices

Table T7 – Recommended Pad Layouts for Surface-mount PolySwitch Telecommunications and Networking Devices in Millimeters (Inches) Nominal

Device	A	B	C	D	E	F	G	Figure
TS250 (All)	4.60 (0.180)	1.80 (0.070)	6.10 (0.240)	—	—	—	—	T17
TSV250 (All)	2.29 (0.090)	2.41 (0.095)	6.35 (0.250)	3.43 (0.135)	—	—	—	T18
TSL250 (All)	3.60 (0.140)	1.80 (0.070)	5.50 (0.220)	—	—	—	—	T17
TS600 (All)	10.42 (0.410)	3.30 (0.130)	3.35 (0.132)	—	—	—	—	T17
TSM600 (All)	5.20 (0.205)	17.80 (0.701)	5.54 (0.218)	6.75 (0.266)	2.08 (0.082)	3.12 (0.123)	8.39 (0.331)	T19

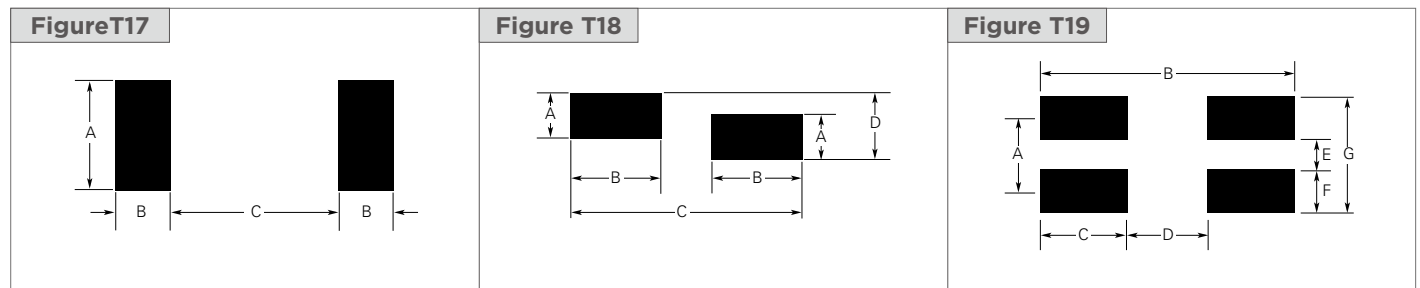

Solder Reflow and Rework Recommendations for PolySwitch Telecommunications Surface-Mount Devices

Profile Feature	Pb-Free Assembly
Average ramp up rate (T_{s_MAX} to T_p)	3°C/s max
Preheat	
• Temperature min (T_{s_MIN})	150°C
• Temperature max (T_{s_MAX})	200°C
• Time (t_{s_MIN} to t_{s_MAX})	60-180 s
Time maintained above:	
• Temperature (T_L)	217°C
• Time (t_L)	60-150 s
Peak/Classification temperature (T_p)	260°C
Time within 5°C of actual peak temperature	
Time (t_p)	20-40 s
Ramp down rate	6°C/s max
Time 25°C to peak temperature	8min max

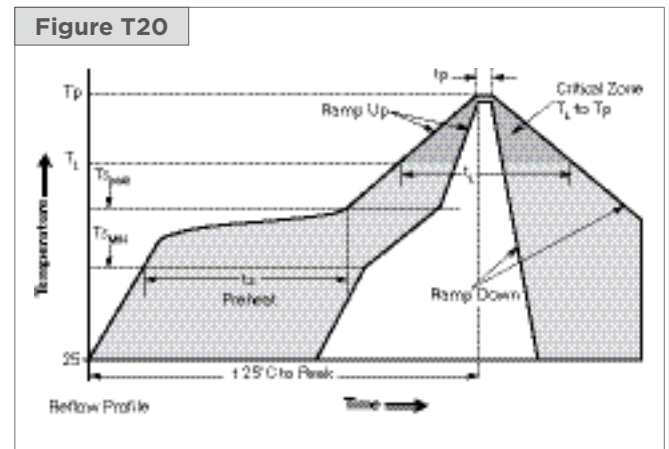

Note: All temperatures refer to topside of the package, measured on the package body surface.

Solder Reflow

- Recommended reflow method: IR, vapor phase oven, hot air oven.
- Surface-mount devices are not intended to be wave soldered to the bottom side of the board.
- Recommended maximum paste thickness of 0.25mm (0.010in).
- Devices can be cleaned using standard industry methods and solvents.

Rework

- If a device is removed from the board, it should be discarded and replaced with a new device.

PolySwitch Resettable Devices

Telecommunications and Networking Devices

Wave Soldering and Rework Recommendations for PolySwitch Telecommunications Radial-Leaded Devices

Recommended Wave Soldering

- Soldering temperature profile

Temperature characteristic at component terminal with dual wave soldering

Rework

- If a device is removed from the board, it should be discarded and replaced with a new device



Table T8 – TRF250/TRF600 Tape and Reel Specifications

TRF250/TRF600 devices are available in tape and reel packaging per EIA 468-B standard.

Dimension	EIA Mark	IEC Mark	Dimension (mm)	Tolerance
Carrier Tape Width	W	W	18	-0.5/+1.0
Hold Down Tape Width	W ₄	W ₀	5	Min
Top Distance between Tape Edges	W ₆	W ₂	3	Max
Sprocket Hole Position	W ₅	W ₁	9	-0.5/+0.75
Sprocket Hole Diameter	D ₀	D ₀	4	±0.2
Abcissa to Plane (Straight Lead)	H	H	18.5	±3.0
Abcissa to Plane (Kinked Lead)*	H ₀	H ₀	16	-0.5/+0.6
Abcissa to Top	H ₁	H ₁	38.5	Max
Overall Width with Lead Protrusion	—	C ₁	43.2	Max
Overall Width without Lead Protrusion	—	C ₂	42.5	Max
Lead Protrusion	L ₁	I ₁	1.0	Max
Protrusion of Cut-out	L	L	11	Max
Protrusion beyond Hold Down Tape	I ₂	I ₂	Not Specified	—
Sprocket Hole Pitch	P ₀	P ₀	12.7	±0.3
Device Pitch (TRF250 and TRF600-150)	—	—	12.7	—
Device Pitch (TRF600-160 - TRF600-400)	—	—	25.4	—
Pitch Tolerance	—	—	20 Consecutive	±1
Tape Thickness	t	t	0.9	Max
Tape Thickness with Splice*	t ₁	—	2.0	Max
Splice Sprocket Hole Alignment	—	—	0	±0.3
Body Lateral Deviation	Dh	Dh	0	±1.0
Body Tape Plane Deviation	Dp	Dp	0	±1.3
Lead Spacing Plane Deviation	DP ₁	P ₁	0	±0.7
Lead Spacing*	F	F	5.08	±0.6
Reel Width	w ₂	w	56	Max
Reel Diameter	a	d	370	Max
Space between Flanges Less Device	w ₁	—	4.75	±3.25
Arbor Hole Diameter	c	f	26	±12.0
Core Diameter	n	h	80	Max
Box	—	—	56/372/372	Max
Consecutive Missing Pieces*	—	—	3 Max	—
Empty Places per Reel*	—	—	Not Specified	—

* Differs from EIA specification.

PolySwitch Resettable Devices

Telecommunications and Networking Devices

Figure T22 — EIA Referenced Taped Component Dimensions for PolySwitch Telecommunications Radial-Leaded Devices

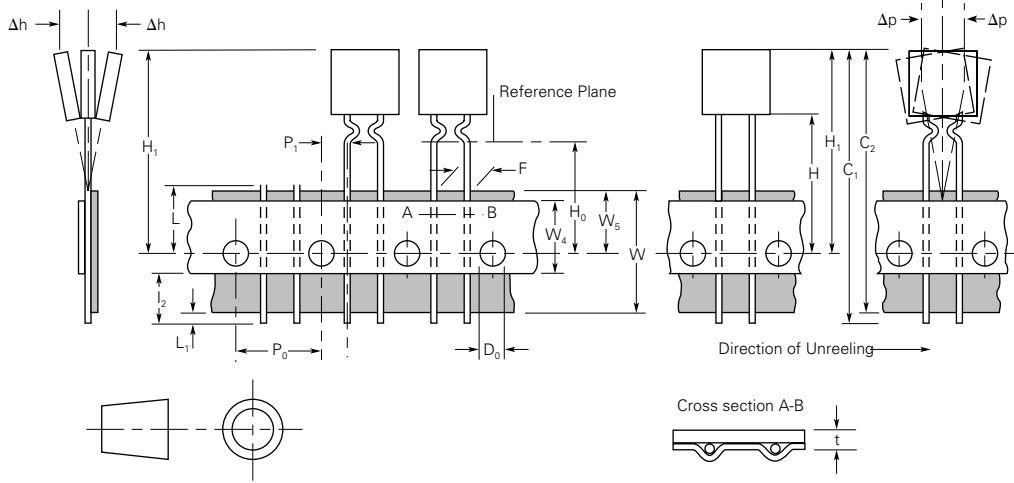

Figure T23 — Reel Dimensions for PolySwitch Telecommunications Radial-Leaded Devices



PolySwitch Resettable Devices

Telecommunications and Networking Devices

Table T9 – TS Tape and Reel Specifications

TS devices are packaged per EIA 481 and EIA 481-2 standards.

TS250/TSL250/TSV250							
Dimension		TS250		TSV250		TSL250	
Description	EIA Mark	Dimension (mm)	Tolerance (mm)	Dimension (mm)	Tolerance (mm)	Dimension (mm)	Tolerance (mm)
Carrier Tape Width	W	16	±0.30	16.0	±0.30	16	±0.30
Sprocket Hole Pitch	P ₀	4.0	±0.10	4.0	±0.10	4.0	±0.10
	P ₁	12.0	±0.10	8.0	±0.10	8.0	±0.10
	P ₂	2.0	±0.10	2.0	±0.10	2.0	±0.10
	A ₀	6.9	±0.23	5.5	±0.10	5.5	±0.10
	B ₀	9.6	±0.15	6.2	±0.10	7.9	±0.10
	B ₁ max	12.1	—	8.0	—	9.2	—
Sprocket Hole Diameter	D ₀	1.5	-0/+0.1	1.55	±0.05	1.55	±0.05
	F	7.5	±0.10	7.5	±0.10	7.5	±0.10
	E ₁	1.75	±0.10	1.75	±0.10	1.75	±0.10
	E ₂ min	14.25	—	—	—	—	—
Tape Thickness	T max	0.4	—	0.45	—	0.35	—
Tape Thickness With	T ₁ max	0.1	—	0.1	—	0.1	—
Splice Cover Tape Thickness	K ₀	3.4	±0.15	7.0	±0.10	3.70	±0.10
	Leader min	300	—	390	—	390	—
	Trailer min	300	—	160	—	160	—
Reel Dimensions							
Reel Diameter	A max	340	—	340	—	340	—
Core Diameter	N min	50	—	50	—	50	—
Space between Flanges-less Device	W ₁	16.4	-0/+2.0	16.4	-0/+2.0	16.4	-0/+2.0
Reel Width	W ₂ max	22.4	—	22.4	—	22.4	—

TS600			
Dimension			
Description	EIA Mark	Dimension (mm)	Tolerance (mm)
Carrier Tape Width	W	32	±0.3
Sprocket Hole Pitch	P ₀	4.0	±0.1
	P ₁	16	±0.1
	P ₂	2.0	±0.1
	A ₀	10	±0.1
	B ₀	19.2	±0.1
	B ₁ max	21.6	
Sprocket Hole Diameter	D ₀	1.5	-0/+1.0
	F	14.2	±0.1
	E ₁	1.75	±0.1
	E ₂ min	28.4	±0.1
Tape Thickness	T max	0.50	±0.5
Tape Thickness with Splice	T ₁ max	0.1	
	K ₀	13.2	±0.1
	Leader min	390	
	Trailer min	160	
Reel Dimensions			
Reel Diameter	A max	360	
Core Diameter	N min	50	
Space between Flanges-less Device	W ₁	32.4	-0/+2.0
Reel Width	W ₂ max	40	

PolySwitch Resettable Devices

Telecommunications and Networking Devices

Table T9 – TS Tape and Reel Specifications

(Cont'd)

TS devices are packaged per EIA 481 and EIA 481-2 standards.

TSM600			
Dimension			
Description	EIA Mark	Dimension (mm)	Tolerance (mm)
Carrier Tape Width	W	32	±0.3
Sprocket Hole Pitch	P ₀	4.0	±0.1
	P ₁	24	±0.1
	P ₂	2.0	±0.1
	A ₀	11.2	±0.1
	B ₀	17.8	±0.1
	B ₁ max	23.45	
Sprocket Hole Diameter	D	1.5	-0/+1.0
	F	14.2	±0.1
	E ₁	1.74	±0.1
	E ₂ max	28.4	±0.1
Tape Thickness	T max	0.5	±0.5
Tape Thickness with Splice	T ₁ max	0.1	
	K ₀	11.9	±0.1
	Leader min	390	
	Trailer min	160	
Reel Dimensions			
Reel Diameter	A max	360	
Core Diameter	N min	50	
Space between Flanges-less Device	W ₁	32.4	-0/+2.0
Reel Width	W ₂ max	40	

Figure T24 – EIA Referenced Taped Component Dimensions for PolySwitch Telecommunications and Networking Devices



PolySwitch Resettable Devices

Telecommunications and Networking Devices

Figure T25 — EIA Referenced Reel Dimensions for PolySwitch Telecommunications and Networking Devices



PolySwitch Telecommunications and Networking Resistance-Sorted and Resistance-Matched Devices

Most TCF, TRF and TS devices are available in resistance-sorted and/or resistance-matched versions.

Resistance-sorted Devices

Resistance-sorted devices (part number suffix "Rx," where x = 1, 2, A, B, C, F, etc.) are supplied with resistance values that are within specified segments of the device's full range of resistance.

Feature

- Narrow resistance range.

Benefits

- Can help provide greater flexibility for design engineers.
- Lower resistance devices can help provide increased loop length on line card designs.
- Higher resistance devices may help provide greater protection by offering faster time-to-trip.

Resistance-matched Devices

Resistance-matched devices are supplied such that all parts in one particular package (or reel) are within 0.5 Ω of each other (1.0 Ω for TRF250-080T devices). Individual matched packages are supplied from the full resistance range of the specified device.

Feature

- Tighter resistance balance between any two parts in a package.

Benefits

- Resistance-matched devices may help reduce the tip-ring resistance differential, reducing the possibility of line imbalance.

PolySwitch Resettable Devices

Telecommunications and Networking Devices

Part Numbering System for PolySwitch Radial-Leaded Telecommunications and Networking Devices



* F = RoHS compliant, ELV compliant

Part Numbering System for PolySwitch Surface-mount Telecommunications and Networking Devices



Part Numbering System for Chip PolySwitch Telecommunications and Networking Devices

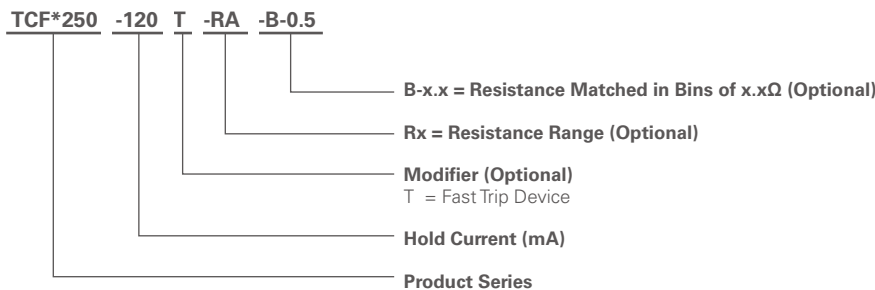

* F = RoHS compliant, ELV compliant