

Sensitive 12 A SCRs

Datasheet - production data

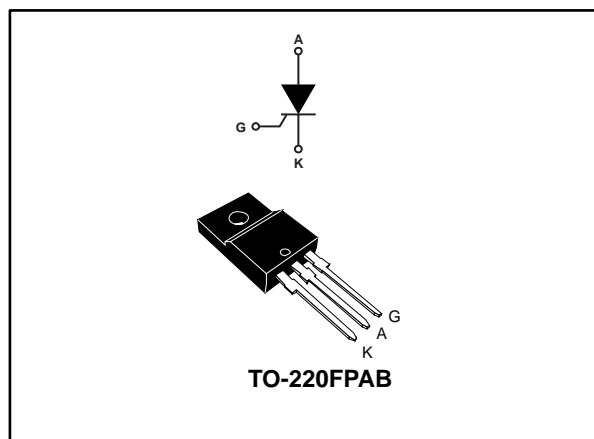

Description

Housed in a fullpack package, this sensitive device fits all sorts of control modes.

It is ideal for applications such as overvoltage crowbar protection, motor control circuits in power tools and kitchen appliances, light dimmers, inrush current-limiting circuits, capacitive discharge ignition and voltage regulation circuits.

Table 1: Device summary

Order code	Package	V _{DRM} /V _{R_{RRM}}	I _{GT}
TS1220-6FP	TO-220FPAB	600 V	200 μA

Features

- On-state RMS current $I_{T(RMS)} = 12 \text{ A}$
- Low gate triggering current $I_{GT} = 200 \mu\text{A}$
- Peak off-state voltage $V_{DRM}/V_{RRM} = 600 \text{ V}$
- ECOPACK®2 compliant component
- UL 1557 standard certified (file ref.: E81734)

Applications

- Voltage regulators
- Inrush current limiting circuits
- Motor control circuits
- Capacitive discharge circuits
- Light dimmers

1 Characteristics

Table 2: Absolute maximum ratings (limiting values), $T_j = 25\text{ °C}$ unless otherwise specified

Symbol	Parameter		Value	Unit
$I_{T(RMS)}$	RMS on-state current (180 ° conduction angle)		$T_c = 76\text{ °C}$ 12	A
$I_{T(AV)}$	Average on-state current (180 ° conduction angle)		$T_c = 73\text{ °C}$ 8	A
I_{TSM}	Non repetitive surge peak on-state current (T_j initial = 25 °C)		$t_p = 8.3\text{ ms}$ 120	A
			$t_p = 10\text{ ms}$ 110	
I^2t	I^2t value for fusing		$t_p = 10\text{ ms}$ 60.5	A ² s
di/dt	Critical rate of rise of on-state current $I_G = 2 \times I_{GT}$, $t_r \leq 100\text{ ns}$		$f = 60\text{ Hz}$ 100	A/ μ s
V_{DRM}/V_{RRM}	Repetitive peak off-state voltage		$T_j = 125\text{ °C}$ 600	V
I_{GM}	Peak gate current	$t_p = 20\text{ }\mu$ s	$T_j = 125\text{ °C}$ 4	A
$P_{G(AV)}$	Average gate power dissipation		$T_j = 125\text{ °C}$ 1	W
V_{RGM}	Maximum peak reverse gate voltage		5	V
T_{stg}	Storage junction temperature range		-40 to +150	°C
T_j	Operating junction temperature range		-40 to +125	°C
T_L	Maximum lead temperature for soldering during 10 s		260	°C
$V_{INS(RMS)}$	Insulation RMS voltage, 60 seconds		2000	V

Table 3: Electrical characteristics ($T_j = 25\text{ °C}$ unless otherwise specified)

Symbol	Test conditions		Value	Unit	
I_{GT}	$V_D = 12\text{ V}$, $R_L = 140\text{ }\Omega$		Max.	200	μ A
V_{GT}			Max.	0.8	V
V_{GD}	$V_D = V_{DRM}$, $R_L = 3.3\text{ k}\Omega$, $R_{GK} = 220\text{ }\Omega$	$T_j = 125\text{ °C}$	Min.	0.1	V
V_{RG}	$I_{RG} = 10\text{ }\mu$ A		Min.	8	V
I_H	$I_T = 50\text{ mA}$, $R_{GK} = 1\text{ k}\Omega$		Max.	5	mA
I_L	$I_G = 1\text{ mA}$, $R_{GK} = 1\text{ k}\Omega$		Max.	6	mA
dV/dt	$V_D = 402\text{ V}$, $R_{GK} = 220\text{ }\Omega$	$T_j = 125\text{ °C}$	Min.	5	V/ μ s
t_{gt}	$I_{TM} = 24\text{ A}$, $V_D = 402\text{ V}$, $I_G = 10\text{ mA}$, $(di_G/dt)_{max} = 0.2\text{ A}/\mu$ s		Typ.	1.9	μ s
t_q	$I_{TM} = 12\text{ A}$, $V_D = 402\text{ V}$, $(di/dt)_{off} = 10\text{ A}/\mu$ s, $V_R = 25\text{ V}$, $dV_D/dt = 1\text{ V}/\mu$ s, $R_{GK} = 220\text{ }\Omega$	$T_j = 110\text{ °C}$	Typ.	200	μ s

Table 4: Static characteristics

Symbol	Test conditions			Value	Unit
V_{TM}	$I_{TM} = 24 \text{ A}$, $t_p = 380 \mu\text{s}$	$T_j = 25 \text{ }^\circ\text{C}$	Max.	1.6	V
V_{TO}	Threshold voltage	$T_j = 125 \text{ }^\circ\text{C}$	Max.	0.85	
R_D	Dynamic resistance	$T_j = 125 \text{ }^\circ\text{C}$	Max.	30	m Ω
I_{DRM} , I_{RRM}	$V_D = V_{DRM}$, $V_R = V_{RRM}$, $R_{GK} = 220 \Omega$	$T_j = 25 \text{ }^\circ\text{C}$	Max.	5	μA
		$T_j = 125 \text{ }^\circ\text{C}$		2	mA

Table 5: Thermal parameters

Symbol	Parameter		Value	Unit
$R_{th(j-c)}$	Junction to case (DC)	Max.	4.5	$^\circ\text{C/W}$
$R_{th(j-a)}$	Junction to ambient (DC)	Typ.	60	

1.1 Characteristics (curves)

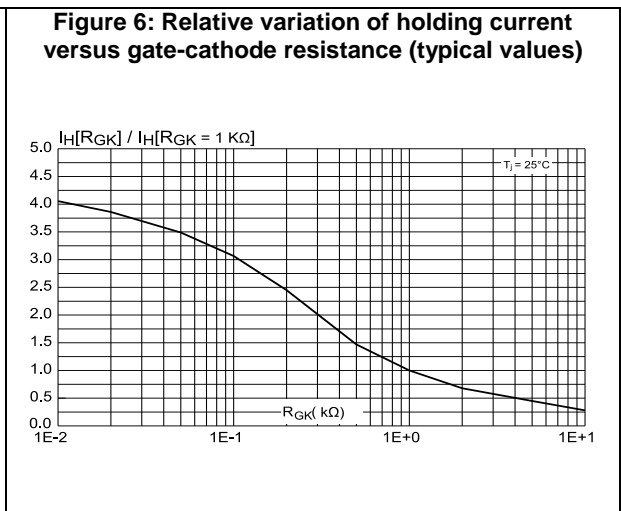
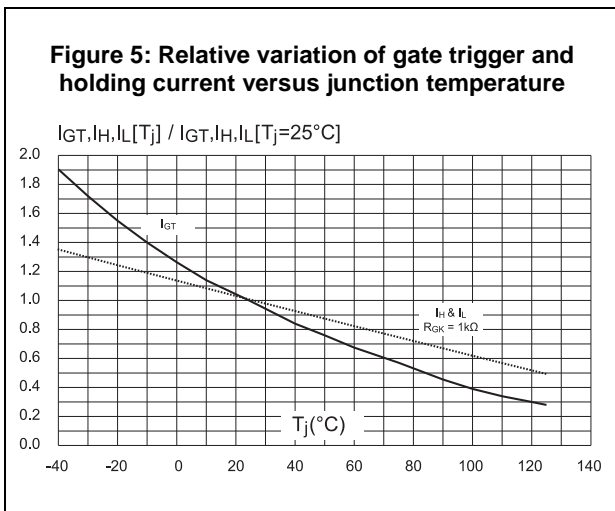
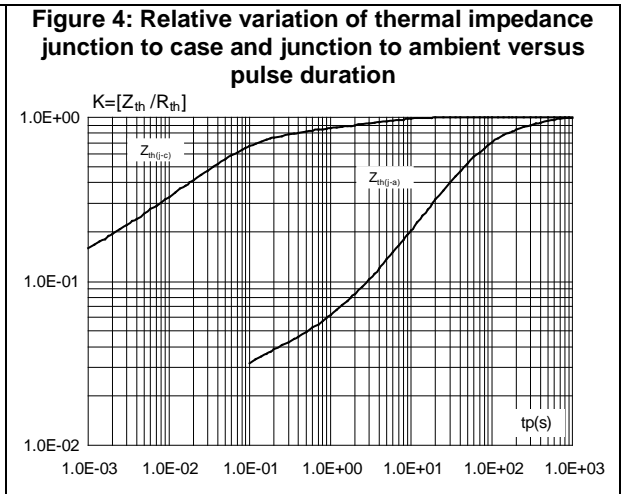
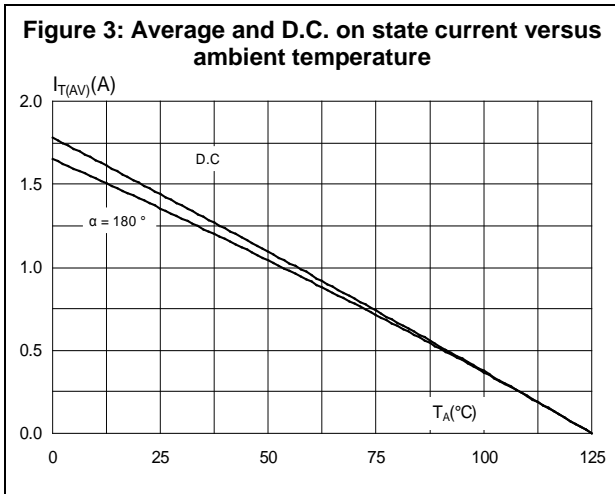
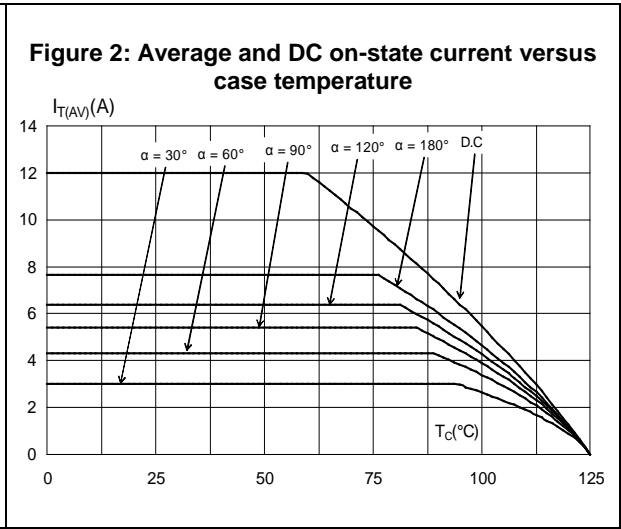
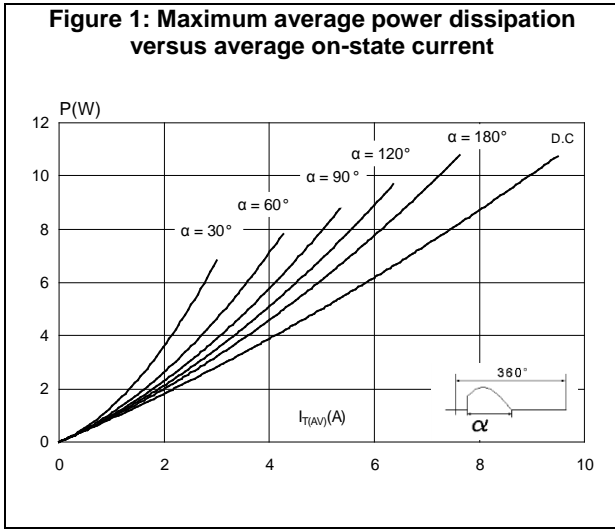

Figure 7: Relative variation of dV/dt immunity versus gate-cathode resistance (typical values)

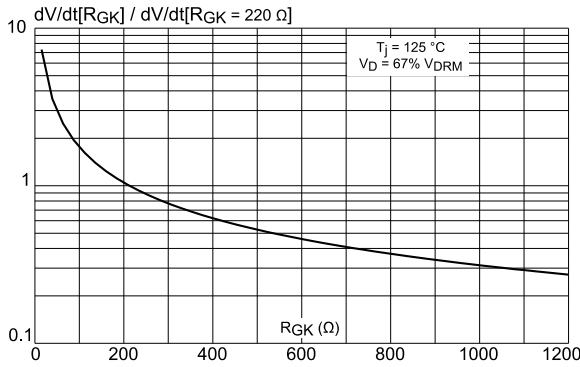

Figure 8: Relative variation of dV/dt immunity current versus gate-cathode capacitance (typical values)

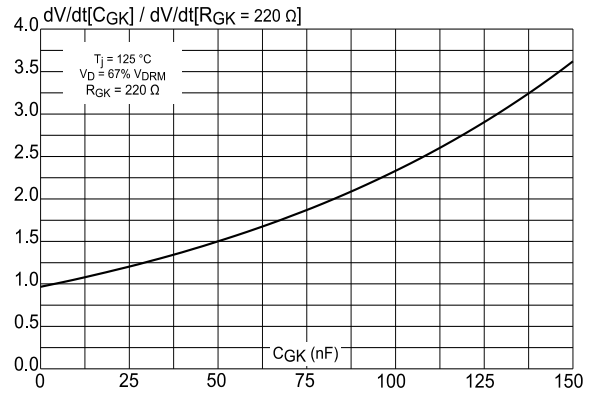

Figure 9: Surge peak on-state current versus number of cycles

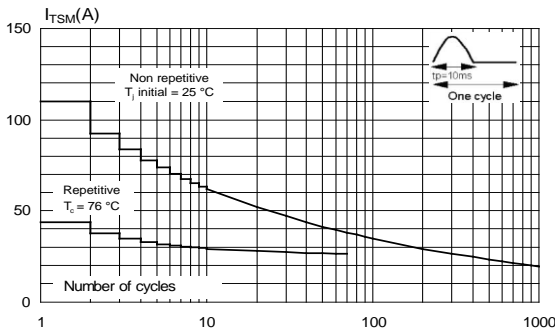

Figure 10: Non repetitive surge peak on-state current for a sinusoidal pulse with width t_p < 10 ms

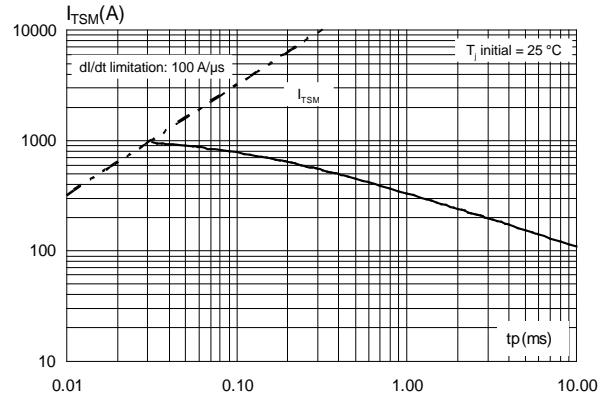
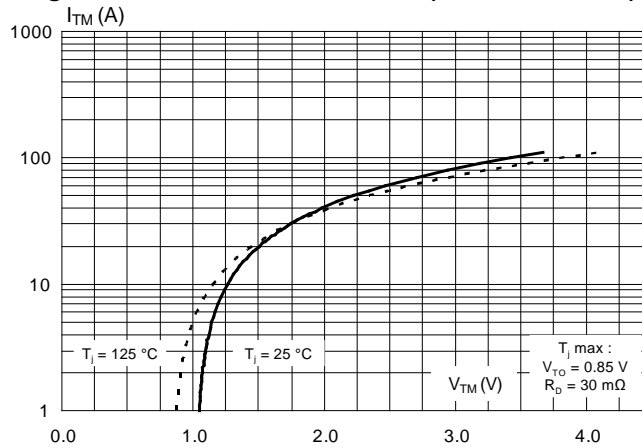

Figure 11: On-state characteristics (maximum values)



2 Package information

In order to meet environmental requirements, ST offers these devices in different grades of ECOPACK® packages, depending on their level of environmental compliance. ECOPACK® specifications, grade definitions and product status are available at: www.st.com. ECOPACK® is an ST trademark.

- Epoxy meets UL94, V0
- Lead-free, halogen-free package
- Recommended torque value (TO-220FPAB): 0.4 to 0.6 N.m

2.1 TO-220AB package information

Figure 12: TO-220FPAB package outline

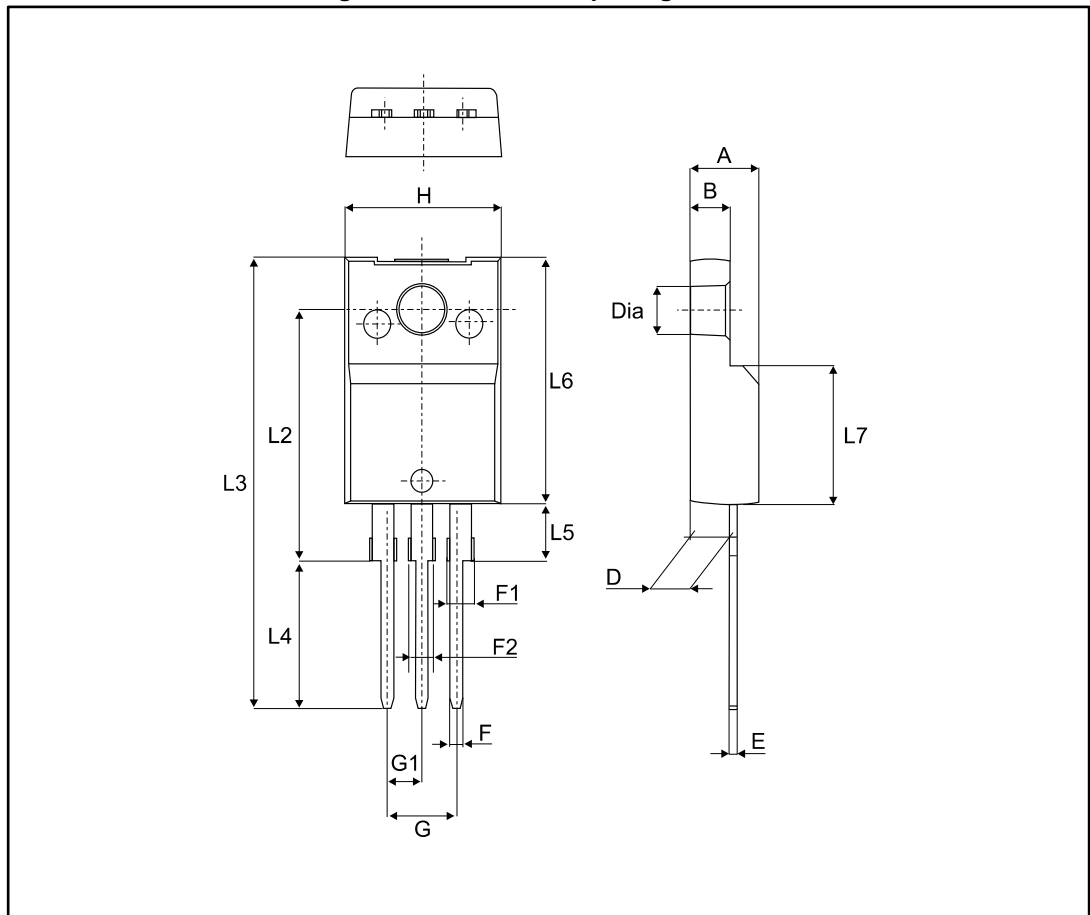

Table 6: TO-220FPAB package mechanical data

Ref.	Dimensions			
	Millimeters		Inches	
	Min.	Max.	Min.	Max.
A	4.40	4.60	0.1739	0.1818
B	2.5	2.7	0.0988	0.1067
D	2.50	2.75	0.0988	0.1087
E	0.45	0.70	0.0178	0.0277
F	0.75	1.0	0.0296	0.0395
F1	1.15	1.70	0.0455	0.0672
F2	1.15	1.70	0.0455	0.0672
G	4.95	5.20	0.1957	0.2055
G1	2.40	2.70	0.0949	0.1067
H	10.00	10.40	0.3953	0.4111
L2	16.00 typ.		0.6324 typ.	
L3	28.60	30.60	1.1304	1.2095
L4	9.80	10.6	0.3874	0.4190
L5	2.90	3.60	0.1146	0.1423
L6	15.90	16.40	0.6285	0.6482
L7	9.00	9.30	0.3557	0.3676
Dia	3.0	3.20	0.1186	0.1265

3 Ordering information

Figure 13: Ordering information scheme

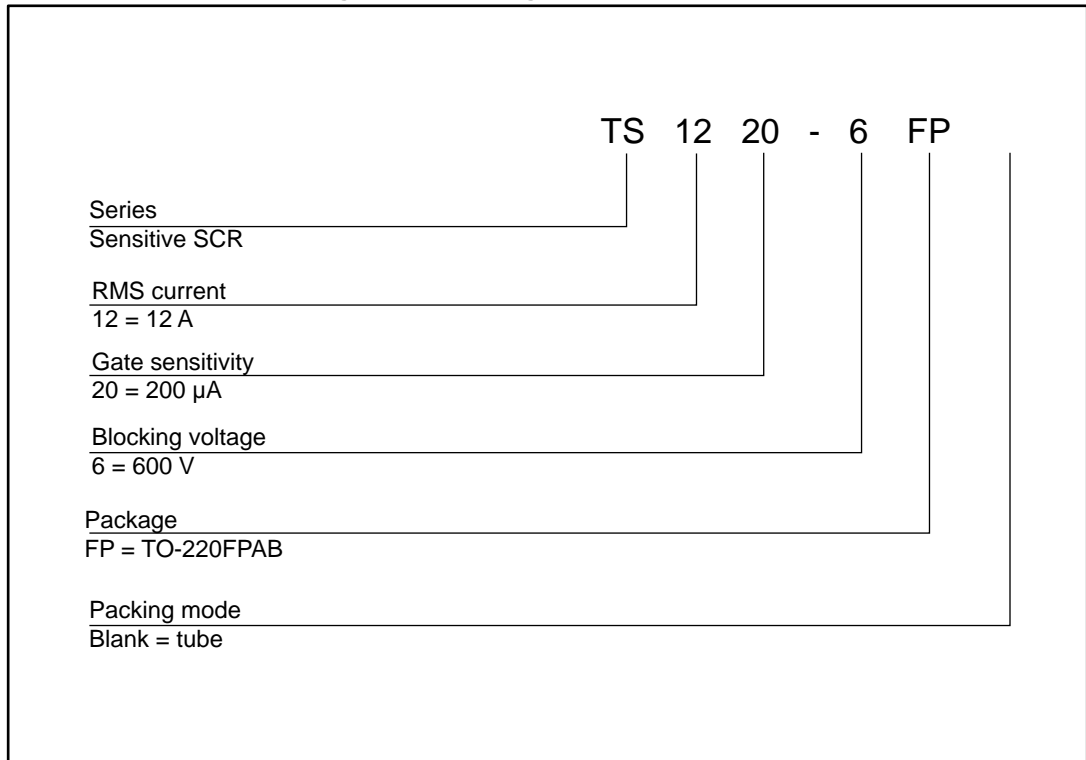

Table 7: Ordering information

Order code	Marking	Package	Weight	Base qty.	Delivery mode
TS1220-6FP	TS1220-6	TO-220FPAB	2.0 g	50	Tube

4 Revision history

Table 8: Document revision history

Date	Revision	Changes
31-Aug-2017	1	Initial release.