

### TRIUNE PRODUCTS

---

## Features

- Ultra-low nA operating current at light load
- Best-in-class quiescent current of 20nA at Iload=0
- Best-in-class quiescent current of 100pA in disable mode
- Output voltage options of 1.2V - 4.2V in 100mV steps (programmed at manufacturing)
- Accurate output regulation
- Over-current protection

## Summary Specifications

- Low input operating voltage of 2.5V to 5.5V
- Packaged in a 8pin DFN (2x2)
- Product is lead-free, Halogen Free, RoHS / WEEE compliant

## Description

The TS14002 linear regulator is an ultra-low-power circuit which draws low nA level quiescent current at light load, but has the capability to regulate current loads as high as 150mA.

## Applications

- Portable electronics
- RFID
- Industrial
- Medical
- Energy harvesting systems
- SmartCard

## Typical Applications

---

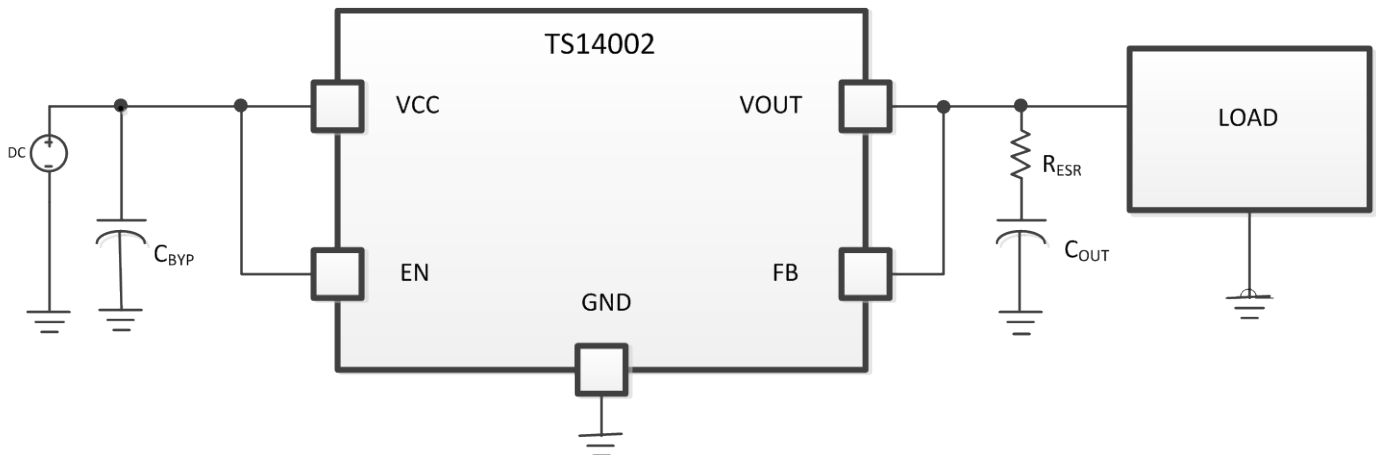

## Block Diagram

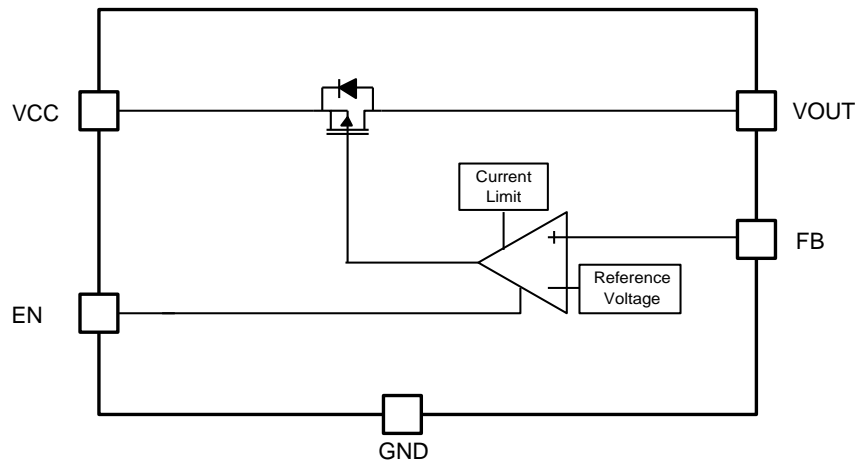

## Pin Description

Pin #	Pin Name	Pin Type <sup>(1)</sup>	Description
1	GND	P	Ground
2	V <sub>OUT</sub>	O	Regulated Output Voltage
3	NC		No Connect (connect to GND or float)
4	NC		No Connect (connect to GND or float)
5	NC		No Connect (connect to GND or float)
6	FB	I	Feedback Input
7	V <sub>CC</sub>	P	Input Power
8	EN	I	Enable Input

(1) I = Input, O = Output, P = Power

## Absolute Maximum Rating

Over operating free-air temperature range unless otherwise noted<sup>(2, 3, 4)</sup>

Parameter	Value	Unit
V <sub>CC</sub> , V <sub>OUT</sub> , EN, FB	-0.3 to 6.0	V
Electrostatic Discharge (Human Body Model)	2	kV
Operating Junction Temperature Range, T <sub>J</sub>	-40 to 85	°C
Storage Temperature Range, T <sub>STG</sub>	-65 to 150	°C
Reflow Temperature (soldering, 10 seconds)	260	°C

(2) Stresses beyond those listed under “absolute maximum ratings” may cause permanent damage to the device. These are stress ratings only, and functional operation of the device at these or any other conditions beyond those indicated under “recommended operating conditions” is not implied. Exposure to absolute-maximum-rated conditions for extended periods may affect device reliability.

(3) All voltage values are with respect to network ground terminal.

(4) ESD testing is performed according to the respective JESD22 JEDEC standard.

## Thermal Characteristics

Package DFN	$\theta_{JA}$ (°C/W) (See Note 5)	$\theta_{JC}$ (°C/W) (See Note 6)
8 pin	73.1	10.7

(5) This assumes a FR4 board only.

(6) This assumes a 1 Oz. Copper JEDEC standard board with thermal vias – See Exposed Pad section and application note for more information.

## Recommended Operating Conditions

Parameter	Min	Typ	Max	Unit
Unregulated Supply Input Voltage ( $V_{CC}$ )	2.5		5.5	V
Enable Input (EN)	0		5	V
Regulated Supply Output Voltage ( $V_{OUT}$ ) typical	1.2		4.2	V
Operating Ambient Temperature, $T_A$ (Note 7)	-40		55	°C
Operating Junction Temperature, $T_J$	-40		85	°C
Input Bypass Capacitor ( $C_{BYP}$ )		2.2		uF
Output Bypass Capacitor ( $C_{OUT}$ )	1	2.2	4.7	uF

(7)  $T_A$  Max shown here is a guideline. Higher  $T_A$  can be tolerated if  $T_J$  does not exceed the Absolute Maximum Rating.

## Characteristics

Electrical characteristics,  $V_{CC} = 2.5V$  to  $5.5V$ ,  $T_J = 25C$ ,  $C_{OUT} = 2.2uF$  unless otherwise noted

Symbol	Parameter	Condition	Min	Typ	Max	Unit
$V_{CC}$	Input Supply Voltage		2.5		5.5	V
$V_{il_{EN}}$	Input Low Logic Level				$0.3 \cdot V_{CC}$	V
$V_{ih_{EN}}$	Input High Logic Level		$0.7 \cdot V_{CC}$			V
$I_{qq}$	Quiescent Current (note 9)	$V_{CC} = 2.5V$ to $5.5V$ , $I_{OUT} = 0$ (Note 9)		20		nA
$I_{qq-disable}$	Quiescent Current: Disable Mode	$I_{OUT} = 0$ , EN = 0		100		pA
$I_{op-gnd}$	Operating Current	$V_{CC} = V_{CC\_MIN}$ , $I_{OUT} = 150mA$ (Note 8)		200		uA
$I_{out}$	Load Capability	$V_{out\_nominal}$ from 1.2V to 3.5V	0		150	mA
		$V_{out\_nominal} > 3.5V$	0		100	

(8) If  $V_{out\_nominal} < 2.5V$ , then  $V_{CC\_MIN} = 2.5V$ , otherwise  $V_{CC\_MIN} = V_{out} + 0.3V$ .  $V_{CC\_MAX}$  is always 5.5V.  $V_{CC\_NOM}$  is the average of  $V_{CC\_MAX}$  and  $V_{CC\_MIN}$ .

(9) Not tested in production, but has been evaluated on samples

## Characteristics Continued

Electrical characteristics,  $V_{CC} = 2.5V$  to  $5.5V$ ,  $T_J = 25C$ , unless otherwise noted

Symbol	Parameter	Condition	Min	Typ	Max	Unit
$V_{Line}$	DC Line Regulation	$V_{CC} = V_{CC\_MIN}$ to $V_{CC\_MAX}$ $V_{OUT} = 1.8V$ to $4.2V$ , $I_{OUT} = 50mA$		0.5	4	%
		$V_{CC} = V_{CC\_MIN}$ to $V_{CC\_MAX}$ $V_{OUT} < 1.8V$ , $I_{OUT} = 50mA$			4	%
$V_{Load}$	DC Load Regulation	$V_{CC} = V_{CC\_NOM}$ $I_{OUT} = 0.02mA$ to $150mA$ ,		1	3	%
$I_{limit}$	Short circuit current limit	$V_{OUT}$ forced to GND (Note 9)	185	200		mA

(9) Not tested in production, but has been evaluated on samples

# Typical Characteristics

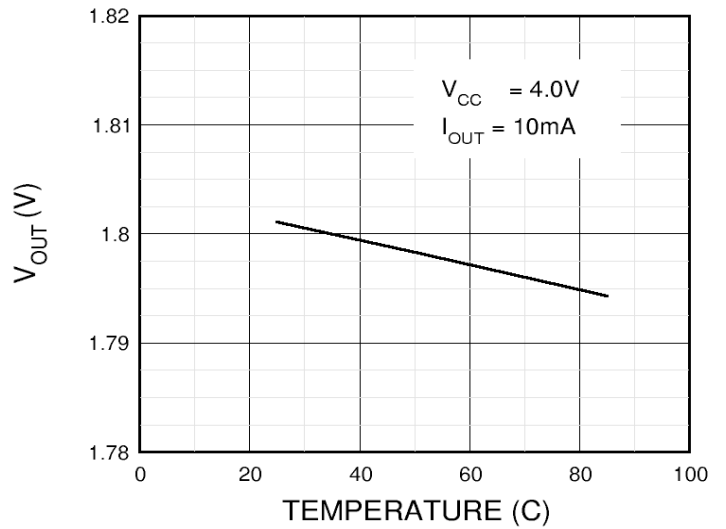
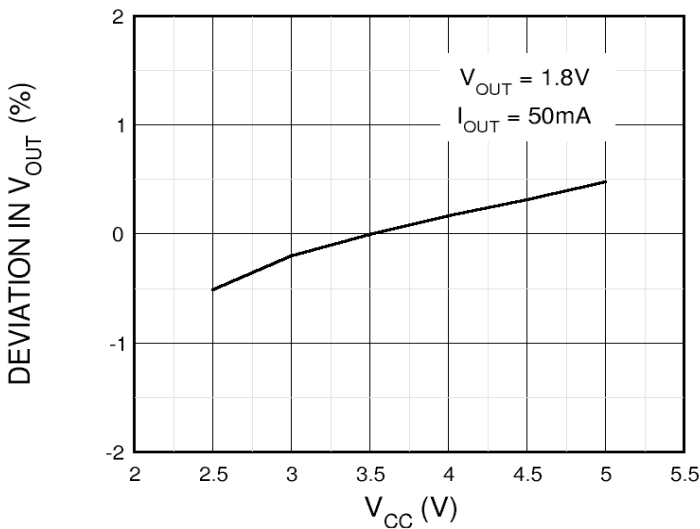
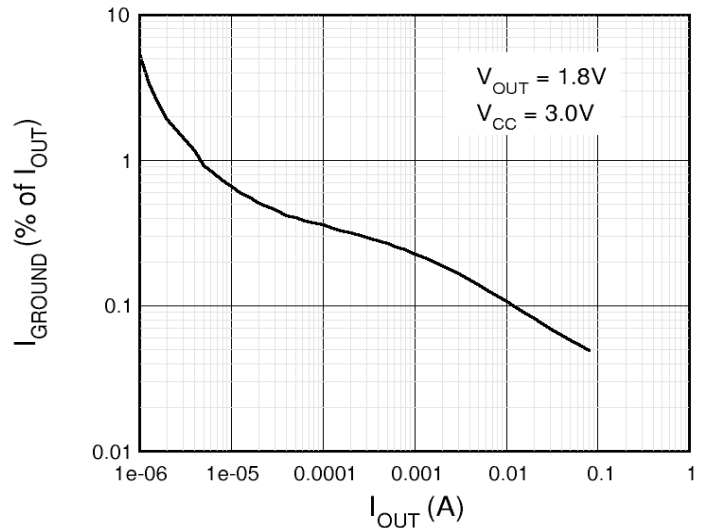
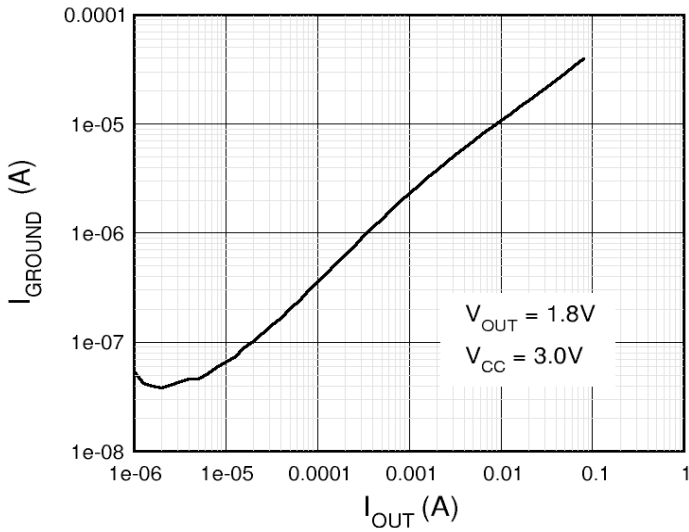
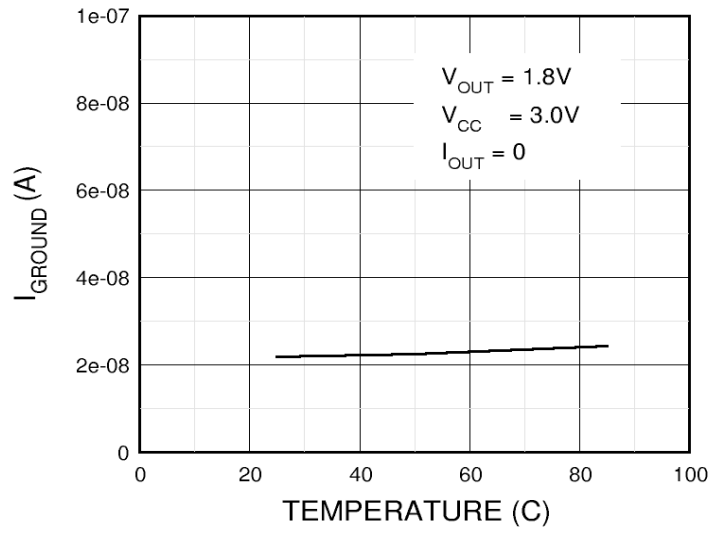
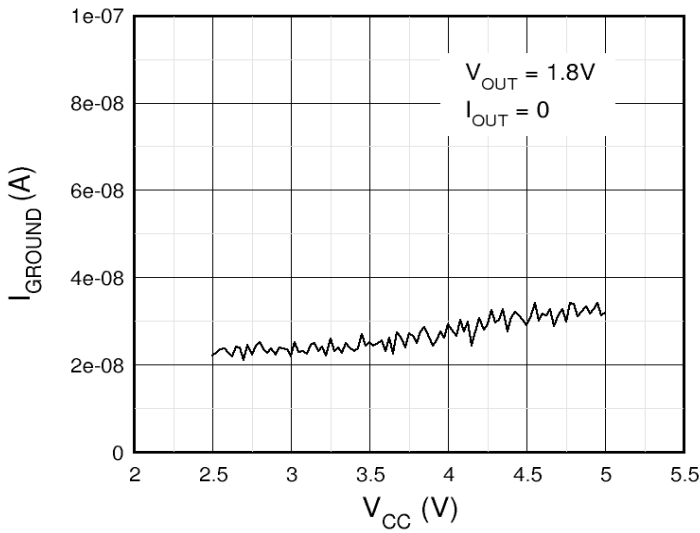

Dropout Voltage When  $V_{OUT}$  Drops By 3%

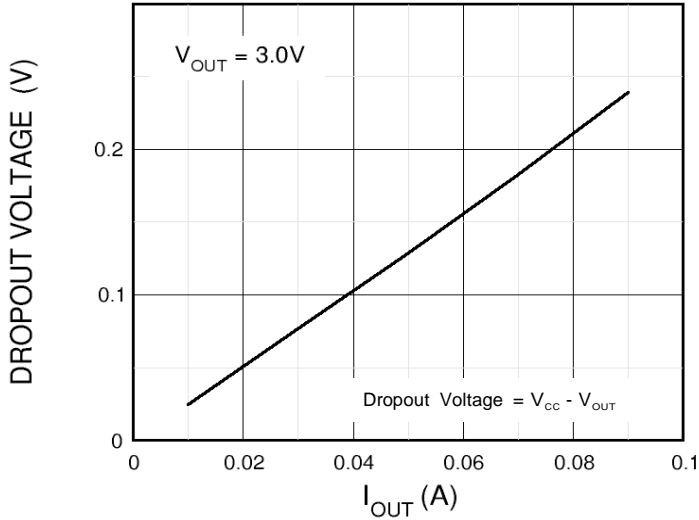

Load Regulation Performance

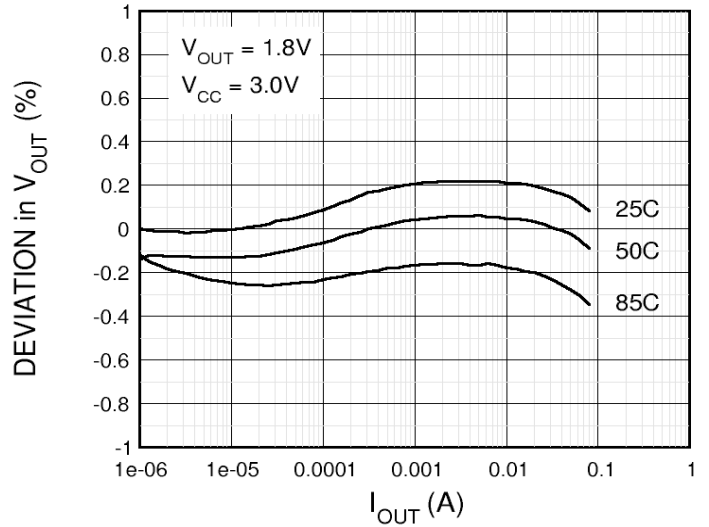

Load Step Response

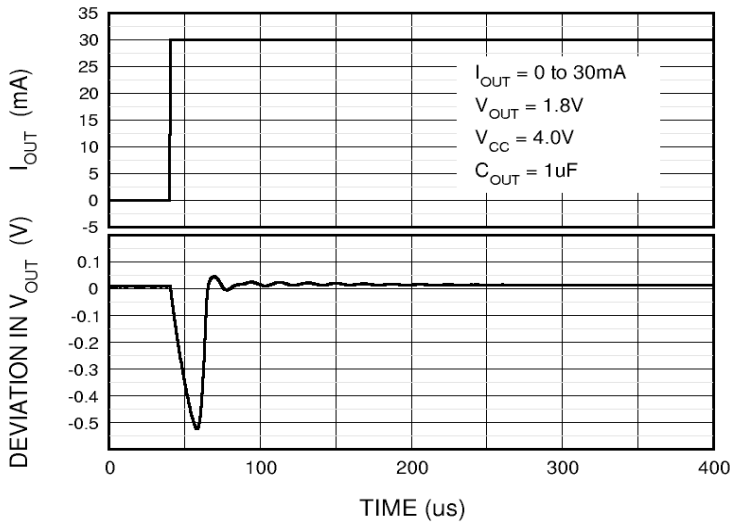

Load Step Response

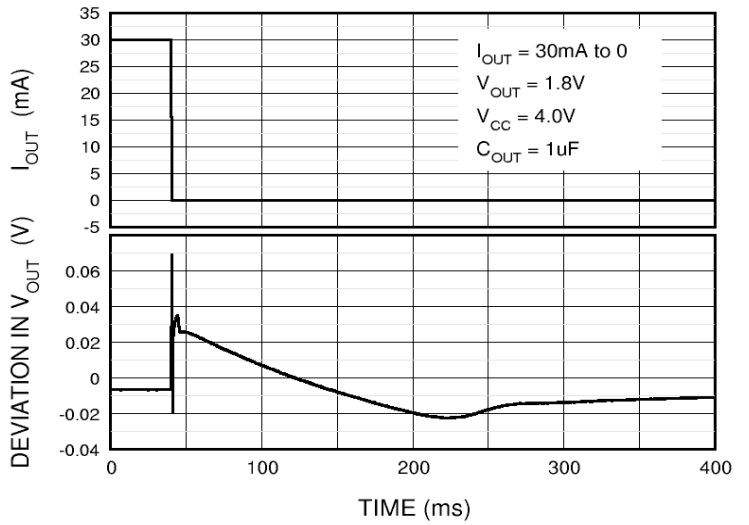

Load Step Response

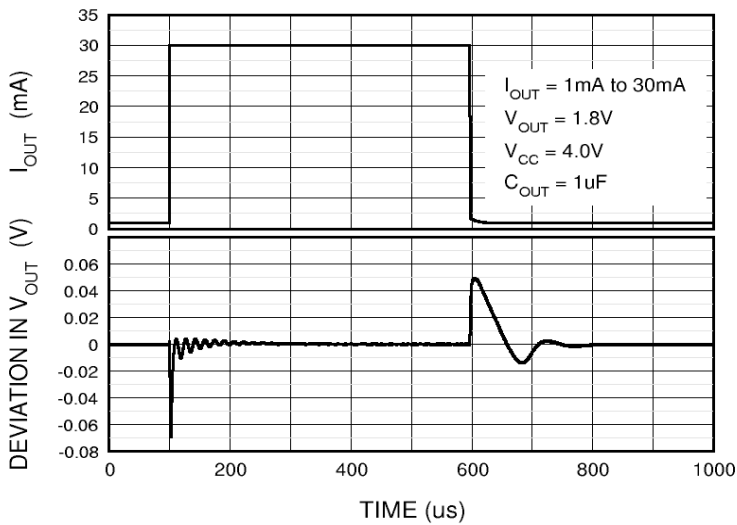

Line Step Response

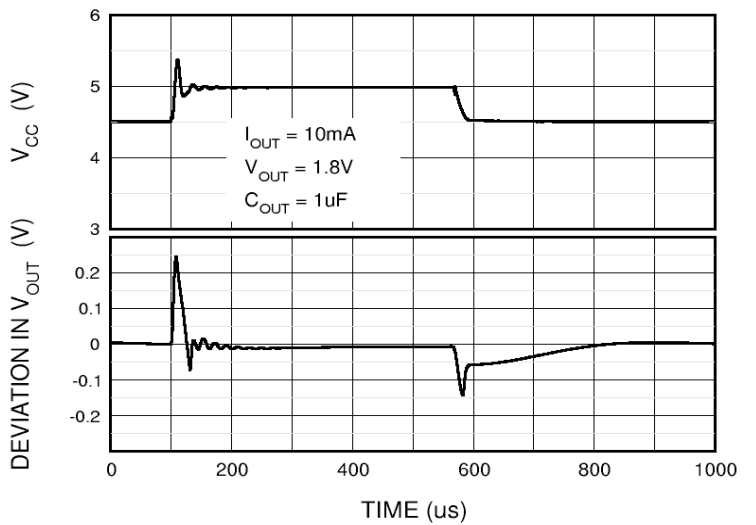

Output Enable Timing

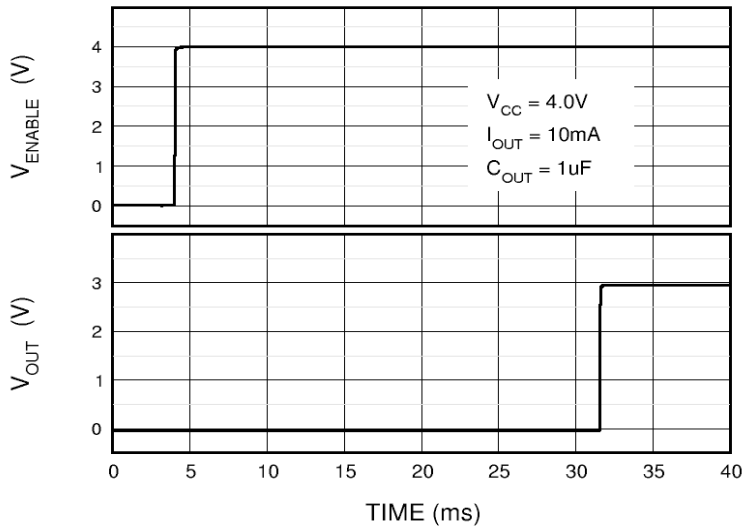

Power Supply Rejection Ratio

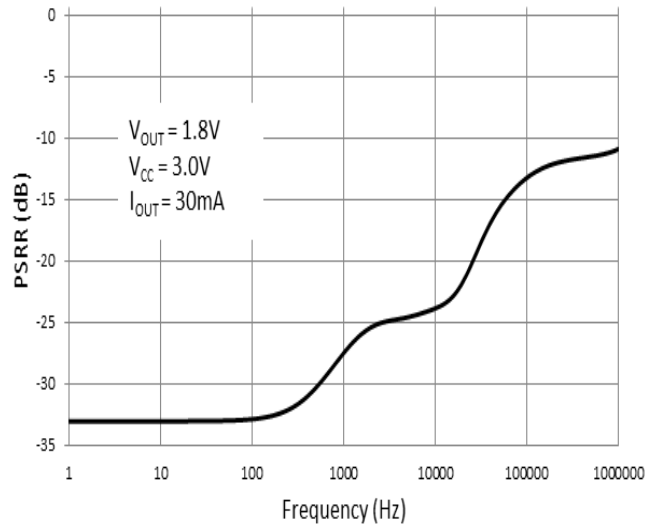

# Package Mechanical Drawings (all dimensions in mm)

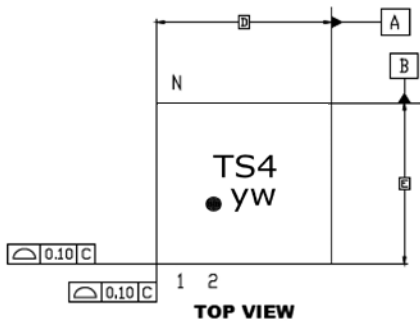

Marking for the 2.0 x 2.0 mm MLPD 8 Lead package:

nnn = Part Number (Example: TS4) - Reference Part No. Code for small MLP  
 yw = Datecode (Reference Package Marking Design Guide lines, Appendix A)

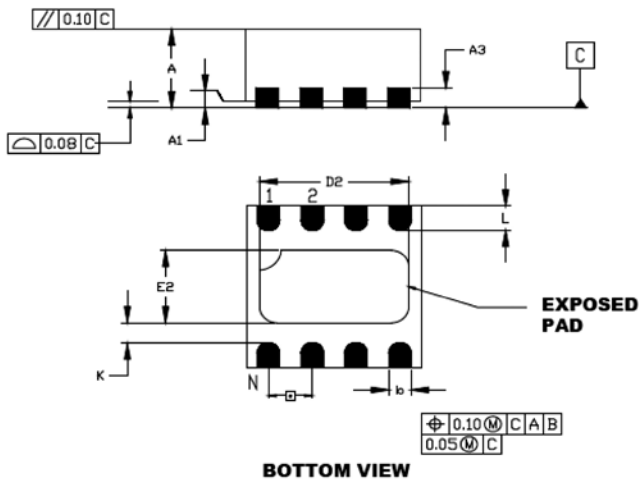

	Units	MILLIMETERS		
		Dimension Limits	MIN	NOM
Number of Pins	N	8		
Pitch	e	0.50 BSC		
Overall Height	A	0.80	0.90	1.00
Standoff	A1	0.00	0.02	0.05
Contact Thickness	A3	0.20 REF		
Overall Length	D	2.00 BSC		
Exposed Pad Width	E2	0.75	0.90	1.00
Overall Width	E	2.00 BSC		
Exposed Pad Length	D2	1.55	1.70	1.80
Contact Width	b	0.18	0.25	0.30
Contact Length	L	0.20	0.30	0.40
Contact-to-Exposed Pad	K	0.20	-	-

**Notes:**

Dimensions and tolerances per ASME Y14.5M.

BSC: Basic Dimension. Theoretically exact values shown without tolerances.

REF: Reference Dimension, usually without tolerance, for information only.



# Recommended PCB Land Pattern

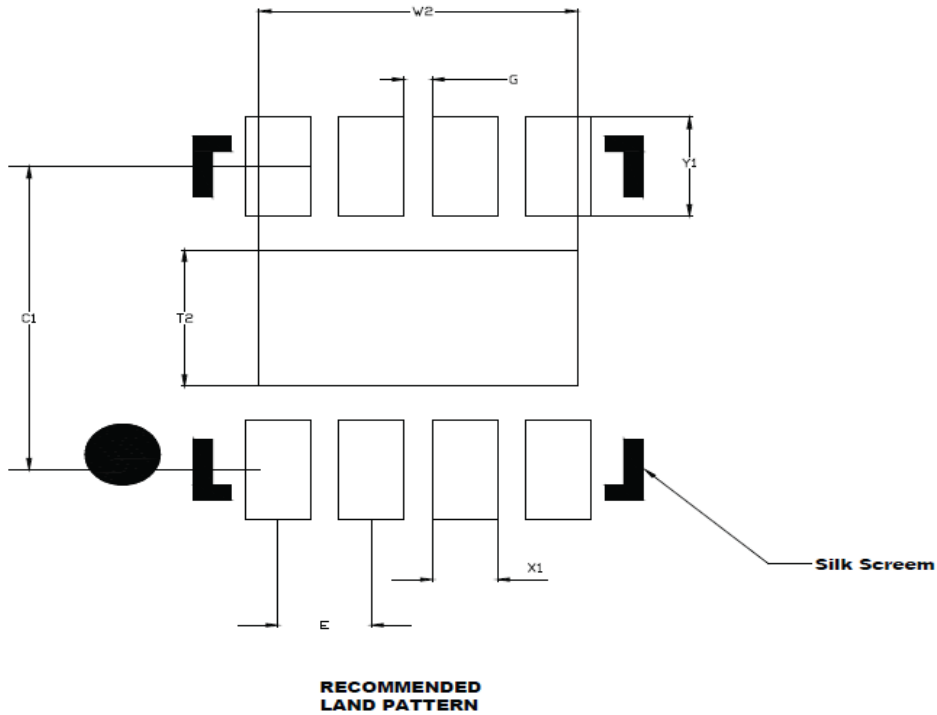

## DIMENSIONS IN MILLIMETERS

	Units	MILLIMETERS		
		Dimension Limits	MIN	NOM
Contact Pitch	E	0.50 BSC		
Optional Center Pad Width	W2	-	-	1.70
Optional Center Pad Length	T2	-	-	0.90
Contact Pad Spacing	C1	-	2.00	-
Contact Pad Spacing	C2	-	-	-
Contact Pad Width (X8)	X1	-	-	0.35
Contact Pad Length (X8)	Y1	-	-	0.65
Distance Between Pads	G	0.15	-	-

---

## Ordering Information

TS14002--CvvvDFNR

Part Number	Description
vvv	Output Voltage*
012	1.2 V
015	1.5 V
018	1.8 V
020	2.0 V
023	2.3 V
025	2.5 V
028	2.8 V
030	3.0 V
033	3.3 V
042	4.2 V

\* Custom values also available (1.2V - 4.2V typical in 100mV increments)