

Features

- Operating range from $V_{CC} = 1.8$ to 6 V
- Rail-to-rail input and output
- Extended V_{icm} ($V_{CC-} - 0.2$ V to $V_{CC+} + 0.2$ V)
- Low supply current (400 μ A)
- Gain bandwidth product (1.6 MHz)
- High unity gain stability
- ESD tolerance (2 kV)
- Latch-up immunity
- Available in
 - SOT23-5 micropackage
 - MiniSO-8, SO-8, SO-14
 - TSSOP8, TSSOP14 package

Applications

- Battery powered applications (toys)
- Portable communication devices (cell phones)
- Audio drivers (headphone drivers)
- Laptop/notebook computers

Description

The TS187x (single, dual and quad) device can operate with voltages as low as 1.8 V. They feature both input and output rail-to-rail.

The common mode input voltage extends 200 mV beyond the supply voltages at 25 °C, while the output voltage swing is within 100 mV of each rail with a 600 Ω load resistor. The devices consume typically 400 μ A per channel while offering 1.6 MHz of gain bandwidth product. The amplifiers provide a high output drive capability at typically 65 mA loads.

These features make the TS187x family ideal for sensor interface, battery supplied and portable applications.

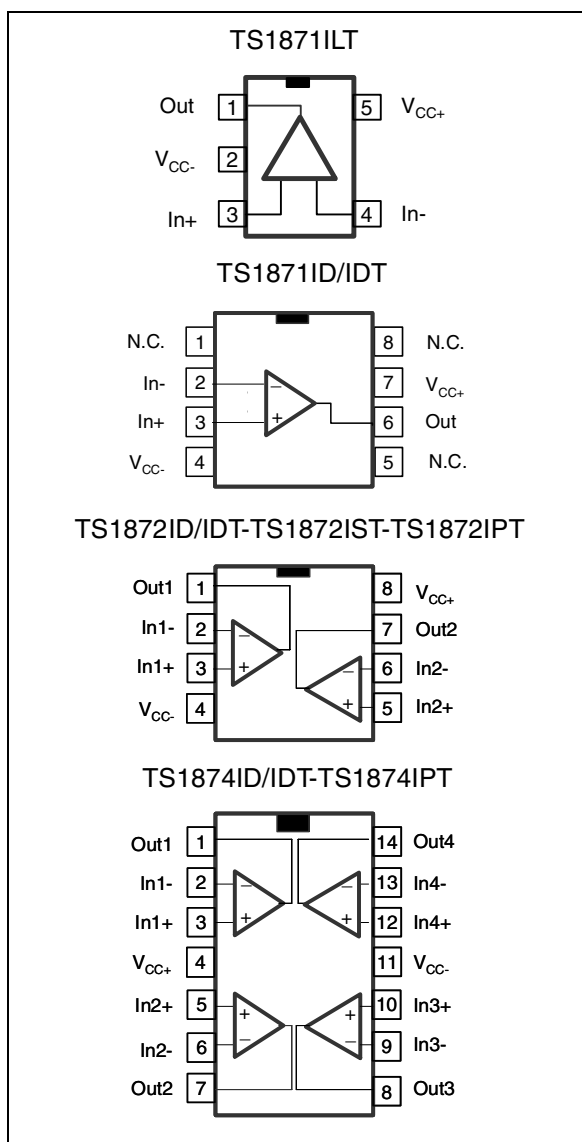

Table 1. Device summary

Reference	Single version	Dual version	Quad version
TS187x	TS1871	TS1872	TS1874
TS187xA	TS1871A	TS1872A	TS1874A

Contents

1	Absolute maximum ratings and operating conditions	3
2	Electrical characteristics	5
3	Package information	16
3.1	SO-8 package information	17
3.2	TSSOP8 package information	18
3.3	MiniSO-8 package information	19
3.4	SO-14 package information	20
3.5	TSSOP14 package information	21
3.6	SOT23-5 package information	22
4	Ordering information	23
5	Revision history	24

1 Absolute maximum ratings and operating conditions

Table 2. Absolute maximum ratings

Symbol	Parameter	Value	Unit
V_{CC}	Supply voltage ⁽¹⁾	7	V
V_{id}	Differential input voltage ⁽²⁾	± 1	V
V_{in}	Input voltage	$V_{CC} - 0.3$ to $V_{CC} + 0.3$	V
T_{stg}	Storage temperature	-65 to +150	°C
T_j	Maximum junction temperature	150	°C
R_{thja}	Thermal resistance junction-to-ambient ⁽³⁾		°C/W
	SOT23-5	250	
	MiniSO-8	190	
	SO-8	125	
	SO-14	103	
	TSSOP8 TSSOP14	120 100	
R_{thjc}	Thermal resistance junction-to-case		°C/W
	SOT23-5	81	
	MiniSO-8	39	
	SO-8	40	
	SO-14	31	
	TSSOP8 TSSOP14	37 32	
ESD	HBM: human body model ⁽⁴⁾	2	kV
	MM: machine model ⁽⁵⁾	200	V
	CDM: charged device model ⁽⁶⁾	1.5	kV
	Latch-up immunity	200	mA
	Lead temperature (soldering, 10 sec.)	250	°C
	Output short-circuit duration	See ⁽⁷⁾	

- All voltage values, except differential voltage, are with respect to network terminal.
- Differential voltages are the non-inverting input terminal with respect to the inverting input terminal. If $V_{id} > \pm 1$ V, the maximum input current must not exceed ± 1 mA. When $V_{id} > \pm 1$ V, add an input series resistor to limit the input current.
- Short-circuits can cause excessive heating. Destructive dissipation can result from simultaneous short-circuits on all amplifiers.
- Human body model: a 100 pF capacitor is charged to the specified voltage, then discharged through a 1.5 k Ω resistor between two pins of the device. This is done for all couples of connected pin combinations while the other pins are floating.
- Machine model: a 200 pF capacitor is charged to the specified voltage, then discharged directly between two pins of the device with no external series resistor (internal resistor < 5 Ω). This is done for all couples of connected pin combinations while the other pins are floating.
- Charged device model: all pins and package are charged together to the specified voltage and then discharged directly to ground through only one pin. This is done for all pins.
- Short-circuits from the output to V_{CC} can cause excessive heating. The maximum output current is approximately 80 mA, independent of the magnitude of V_{CC} . Destructive dissipation can result from simultaneous short-circuits on all amplifiers.

Table 3. Operating conditions

Symbol	Parameter	Value	Unit
V_{CC}	Supply voltage	1.8 to 6	V
V_{icm}	Common-mode input voltage range $T_{oper} = 25\text{ }^{\circ}\text{C}$, $1.8 \leq V_{CC} \leq 6\text{ V}$ $T_{min} < T_{oper} < T_{max}$, $1.8 \leq V_{CC} \leq 6\text{ V}$	$V_{CC-} - 0.2$ to $V_{CC+} + 0.2$ V_{CC-} to V_{CC+}	V
T_{oper}	Operating free air temperature range	-40 to + 125	$^{\circ}\text{C}$

2 Electrical characteristics

Table 4. Electrical characteristics measured at $V_{CC+} = +1.8\text{ V}$ with $V_{CC-} = 0\text{ V}$, C_L and R_L connected to $V_{CC}/2$, and $T_{amb} = 25\text{ °C}$ (unless otherwise specified)⁽¹⁾

Symbol	Parameter	Conditions	Min.	Typ.	Max.	Unit
V_{io}	Input offset voltage	$V_{icm} = V_{out} = V_{CC}/2$ TS1871A/2A/4A $T_{min} \leq T_{amb} \leq T_{max}$ TS1871/2/4 $T_{min} \leq T_{amb} \leq T_{max}$		0.1	1 1.5 3 6	mV
ΔV_{io}	Input offset voltage drift			2		$\mu\text{V}/\text{°C}$
I_{io}	Input offset current	$V_{icm} = V_{out} = V_{CC}/2^{(2)}$ $T_{min} \leq T_{amb} \leq T_{max}$		3	30 60	nA
I_{ib}	Input bias current	$V_{icm} = V_{out} = V_{CC}/2^{(2)}$ $T_{min} \leq T_{amb} \leq T_{max}$		40	125 150	nA
CMR	Common mode rejection ratio $20 \log (\Delta V_{ic}/\Delta V_{io})$	$0 \leq V_{icm} \leq V_{CC}$, $V_{out} = V_{CC}/2$ $T_{min} \leq T_{amb} \leq T_{max}$	55 52	77		dB
A_{vd}	Large signal voltage gain	$V_{out} = 0.5$ to 1.3 V $R_L = 2\text{ k}\Omega$ $R_L = 600\ \Omega$	77 70	91 84		dB
V_{OH}	High level output voltage	$V_{id} = 100\text{ mV}$ $R_L = 2\text{ k}\Omega$ $R_L = 600\ \Omega$ $T_{min} \leq T_{amb} \leq T_{max}$, $R_L = 2\text{ k}\Omega$ $T_{min} \leq T_{amb} \leq T_{max}$, $R_L = 600\ \Omega$	1.65 1.62 1.65 1.62	1.77 1.74		V
V_{OL}	Low level output voltage	$V_{id} = -100\text{ mV}$ $R_L = 2\text{ k}\Omega$ $R_L = 600\ \Omega$ $T_{min} \leq T_{amb} \leq T_{max}$, $R_L = 2\text{ k}\Omega$ $T_{min} \leq T_{amb} \leq T_{max}$, $R_L = 600\ \Omega$		30 46	100 150 100 150	mV
I_o	Output source current	$V_{id} = 100\text{ mV}$, $V_O = V_{CC-}$	20	58		mA
	Output sink current	$V_{id} = -100\text{ mV}$, $V_O = V_{CC+}$	20	68		
I_{CC}	Supply current (per amplifier)	$V_{out} = V_{CC}/2$ $A_{VCL} = 1$, no load $T_{min} \leq T_{amb} \leq T_{max}$		400	560 600	μA
GBP	Gain bandwidth product	$R_L = 10\text{ k}\Omega$, $C_L = 100\text{ pF}$, $f = 100\text{ kHz}$	0.9	1.6		MHz
SR	Slew rate	$R_L = 10\text{ k}\Omega$, $C_L = 100\text{ pF}$, $A_V = 1$	0.38	0.54		$\text{V}/\mu\text{s}$
ϕ_m	Phase margin	$C_L = 100\text{ pF}$		53		Degrees
e_n	Input voltage noise	$f = 1\text{ kHz}$		27		$\text{nV}/\sqrt{\text{Hz}}$
THD	Total harmonic distortion			0.01		%

1. All parameter limits at temperatures different from 25 °C are guaranteed by correlation.
2. Maximum values include unavoidable inaccuracies of the industrial tests.

Table 5. Electrical characteristics measured at $V_{CC} = +3\text{ V}$ with $V_{CC-} = 0\text{ V}$, C_L and R_L connected to $V_{CC}/2$, and $T_{amb} = 25\text{ }^\circ\text{C}$ (unless otherwise specified)⁽¹⁾

Symbol	Parameter	Conditions	Min.	Typ.	Max.	Unit
V_{io}	Input offset voltage	$V_{icm} = V_{out} = V_{CC}/2$ TS1871A/2A/4A $T_{min} \leq T_{amb} \leq T_{max}$ TS1871/2/4 $T_{min} \leq T_{amb} \leq T_{max}$		0.1	1 1.5 3 6	mV
ΔV_{io}	Input offset voltage drift			2		$\mu\text{V}/^\circ\text{C}$
I_{io}	Input offset current	$V_{icm} = V_{out} = V_{CC}/2$ ⁽²⁾ $T_{min} \leq T_{amb} \leq T_{max}$		3	30 60	nA
I_{ib}	Input bias current	$V_{icm} = V_{out} = V_{CC}/2$ ⁽²⁾ $T_{min} \leq T_{amb} \leq T_{max}$		4	125 150	nA
CMR	Common mode rejection ratio $20 \log (\Delta V_{io}/\Delta V_{icm})$	$0 \leq V_{icm} \leq V_{CC}$, $V_{out} = V_{CC}/2$ $T_{min} \leq T_{amb} \leq T_{max}$	60 57	80		dB
A_{vd}	Large signal voltage gain	$V_{out} = 0.5\text{ to }2.5\text{ V}$ $R_L = 2\text{ k}\Omega$ $R_L = 600\ \Omega$	80 74	94 88		dB
V_{OH}	High level output voltage	$V_{id} = 100\text{ mV}$ $R_L = 2\text{ k}\Omega$ $R_L = 600\ \Omega$ $T_{min} \leq T_{amb} \leq T_{max}$, $R_L = 2\text{ k}\Omega$ $T_{min} \leq T_{amb} \leq T_{max}$, $R_L = 600\ \Omega$	2.82 2.80 2.82 2.80	2.95 2.95		V
V_{OL}	Low level output voltage	$V_{id} = -100\text{ mV}$ $R_L = 2\text{ k}\Omega$ $R_L = 600\ \Omega$ $T_{min} \leq T_{amb} \leq T_{max}$, $R_L = 2\text{ k}\Omega$ $T_{min} \leq T_{amb} \leq T_{max}$, $R_L = 600\ \Omega$		39 58	120 160 120 160	mV
I_o	Output source current	$V_{id} = 100\text{ mV}$, $V_O = V_{CC-}$	20	60		mA
	Output sink current	$V_{id} = -100\text{ mV}$, $V_O = V_{CC+}$	20	70		
I_{CC}	Supply current (per amplifier)	$V_{out} = V_{CC}/2$ $A_{VCL} = 1$, no load $T_{min} \leq T_{amb} \leq T_{max}$		450	650 690	μA
GBP	Gain bandwidth product	$R_L = 10\text{ k}\Omega$, $C_L = 100\text{ pF}$, $f = 100\text{ kHz}$	1	1.7		MHz
SR	Slew rate	$R_L = 10\text{ k}\Omega$, $C_L = 100\text{ pF}$, $A_V = 1$	0.42	0.6		V/ μs
ϕ_m	Phase margin	$C_L = 100\text{ pF}$		53		Degrees
e_n	Input voltage noise	$f = 1\text{ kHz}$		27		nV/ $\sqrt{\text{Hz}}$
THD	Total harmonic distortion			0.01		%

1. All parameter limits at temperatures different from 25 °C are guaranteed by correlation.
2. Maximum values include unavoidable inaccuracies of the industrial tests.

Table 6. Electrical characteristics measured at $V_{CC} = +5\text{ V}$ with $V_{CC-} = 0\text{ V}$, C_L and R_L connected to $V_{CC}/2$, and $T_{amb} = 25\text{ °C}$ (unless otherwise specified)⁽¹⁾

Symbol	Parameter	Conditions	Min.	Typ.	Max.	Unit
V_{io}	Input offset voltage	$V_{icm} = V_{out} = V_{CC}/2$ TS1871A/2A/4A $T_{min} \leq T_{amb} \leq T_{max}$ TS1871/2/4 $T_{min} \leq T_{amb} \leq T_{max}$		0.1	1 1.5 3 6	mV
ΔV_{io}	Input offset voltage drift			2		$\mu\text{V}/\text{°C}$
I_{io}	Input offset current	$V_{icm} = V_{out} = V_{CC}/2$ ⁽²⁾ $T_{min} \leq T_{amb} \leq T_{max}$		3	30 60	nA
I_{ib}	Input bias current	$V_{icm} = V_{out} = V_{CC}/2$ ⁽²⁾ $T_{min} \leq T_{amb} \leq T_{max}$		70	130 150	nA
CMR	Common mode rejection ratio $20 \log (\Delta V_{io}/\Delta V_{io})$	$0 \leq V_{icm} \leq V_{CC}$, V_{out} not equal to $V_{CC}/2$ $T_{min} \leq T_{amb} \leq T_{max}$	65 62	85		dB
SVR	Supply voltage rejection ratio $20 \log (\Delta V_{CC}/\Delta V_{io})$	$V_{CC} = 1.8$ to 5 V	70	90		dB
A_{vd}	Large signal voltage gain	$V_{out} = 1$ to 4 V $R_L = 2\text{ k}\Omega$ $R_L = 600\ \Omega$	83 77	97 91		dB
V_{OH}	High level output voltage	$V_{id} = 100\text{ mV}$ $R_L = 2\text{ k}\Omega$ $R_L = 600\ \Omega$ $T_{min} \leq T_{amb} \leq T_{max}$, $R_L = 2\text{ k}\Omega$ $T_{min} \leq T_{amb} \leq T_{max}$, $R_L = 600\ \Omega$	4.80 4.75 4.80 4.75	4.95 4.90		V
V_{OL}	Low level output voltage	$V_{id} = -100\text{ mV}$ $R_L = 2\text{ k}\Omega$ $R_L = 600\ \Omega$ $T_{min} \leq T_{amb} \leq T_{max}$, $R_L = 2\text{ k}\Omega$ $T_{min} \leq T_{amb} \leq T_{max}$, $R_L = 600\ \Omega$		52 70	130 188 130 188	mV
I_o	Output source current	$V_{id} = 100\text{ mV}$, $V_O = V_{CC-}$	20	65		mA
	Output sink current	$V_{id} = -100\text{ mV}$, $V_O = V_{CC+}$	20	80		
I_{CC}	Supply current (per amplifier)	$V_{out} = V_{CC}/2$ $A_{VCL} = 1$, no load $T_{min} \leq T_{amb} \leq T_{max}$		500	835 875	μA
GBP	Gain bandwidth product	$R_L = 10\text{ k}\Omega$, $C_L = 100\text{ pF}$, $f = 100\text{ kHz}$	1	1.8		MHz
SR	Slew rate	$R_L = 10\text{ k}\Omega$, $C_L = 100\text{ pF}$, $A_V = 1$	0.42	0.6		$\text{V}/\mu\text{s}$
ϕ_m	Phase margin	$C_L = 100\text{ pF}$		55		Degrees
e_n	Input voltage noise	$f = 1\text{ kHz}$		27		$\text{nV}/\sqrt{\text{Hz}}$
THD	Total harmonic distortion			0.01		%

1. All parameter limits at temperatures different from 25 °C are guaranteed by correlation.
2. Maximum values include unavoidable inaccuracies of the industrial tests.

Figure 1. Input offset voltage distribution

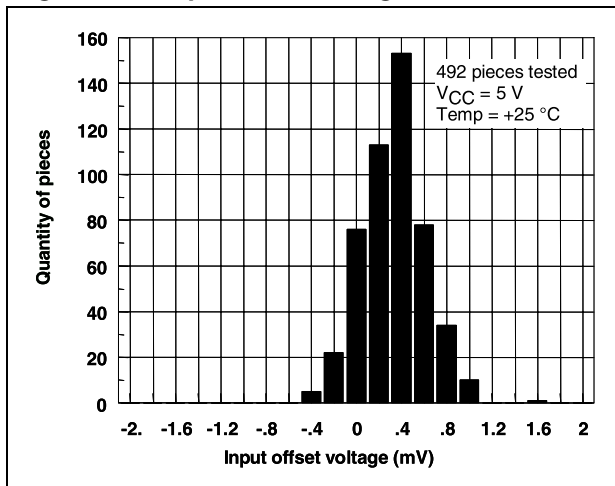

Figure 2. Input offset voltage vs. temperature

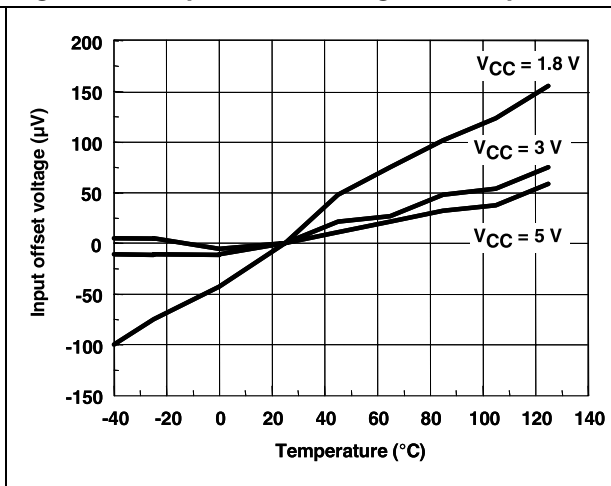

Figure 3. Input bias current vs. temperature at $V_{CC} = 1.8\text{ V}$

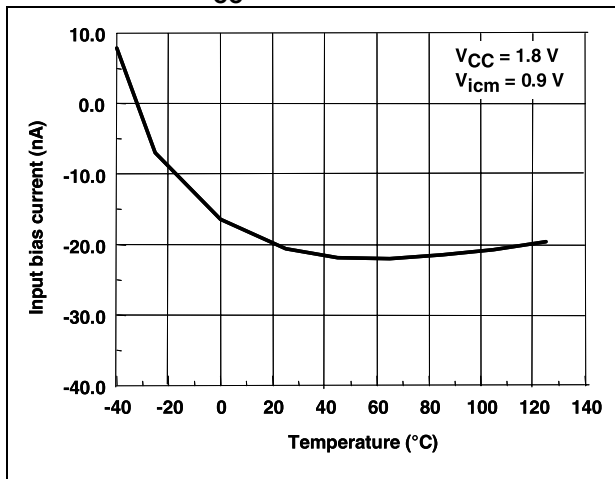

Figure 4. Input bias current vs. temperature at $V_{CC} = 3\text{ V}$

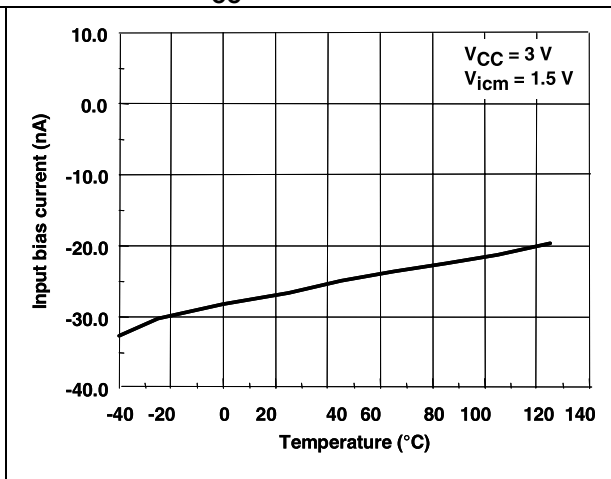

Figure 5. Supply current/amplifier vs. supply voltage

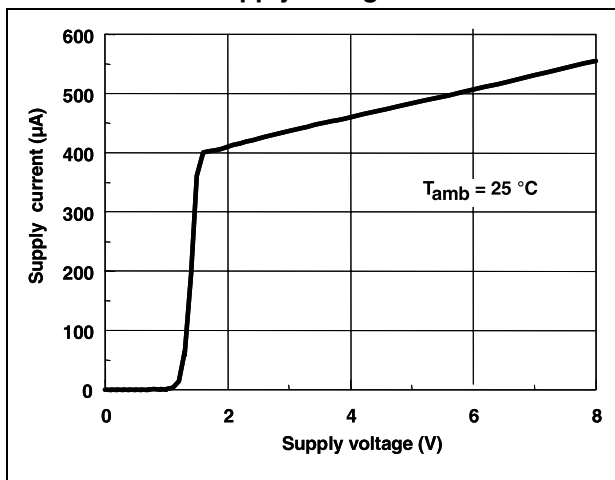

Figure 6. Supply current/amplifier vs. temperature

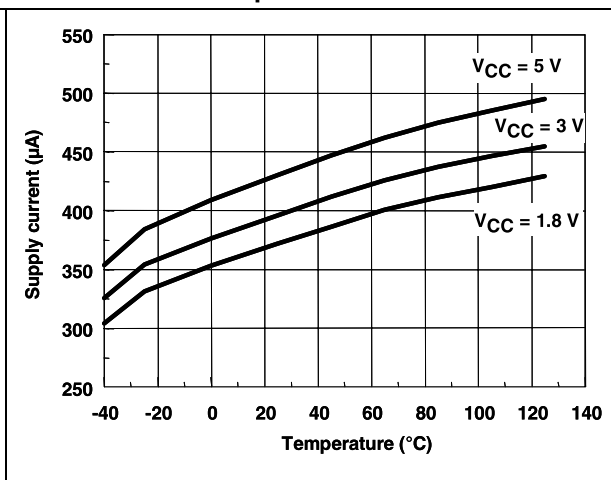

Figure 7. Common mode rejection vs. temperature

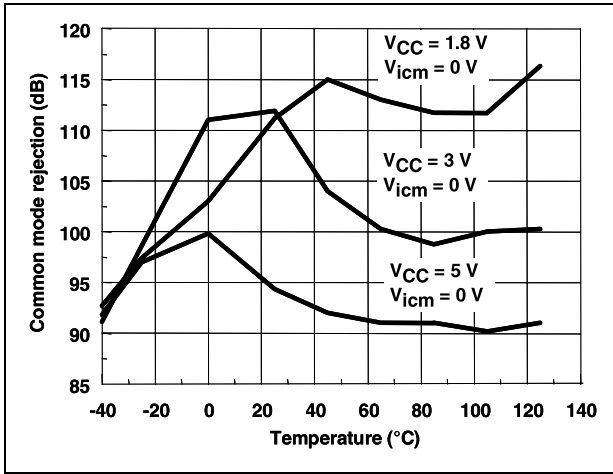

Figure 8. Supply voltage rejection vs. temperature at $V_{CC} = 1.8\text{ V}$

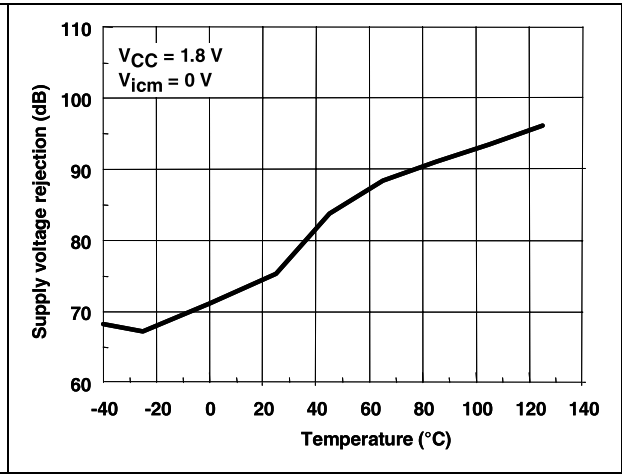

Figure 9. Supply voltage rejection vs. temperature at $V_{CC} = 3\text{ V}$

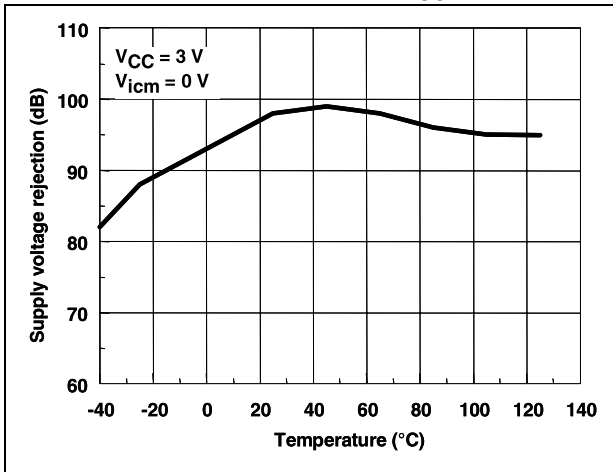

Figure 10. Supply voltage rejection vs. temperature at $V_{CC} = 5\text{ V}$

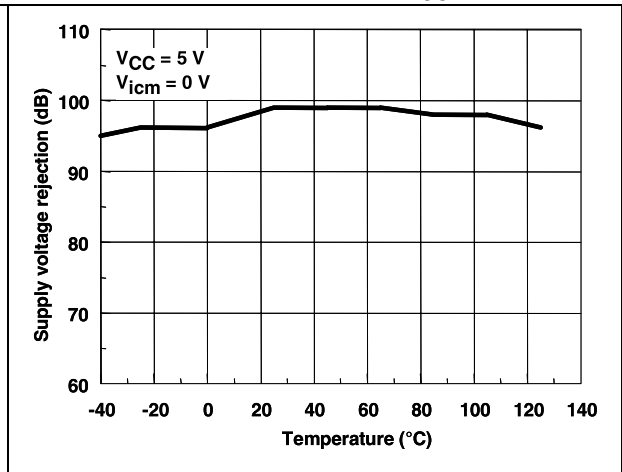

Figure 11. Power supply voltage rejection vs. frequency

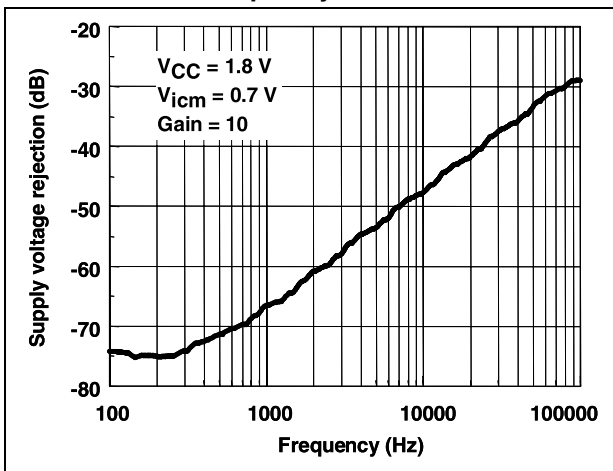

Figure 12. Open loop gain vs. temperature at $V_{CC} = 1.8\text{ V}$

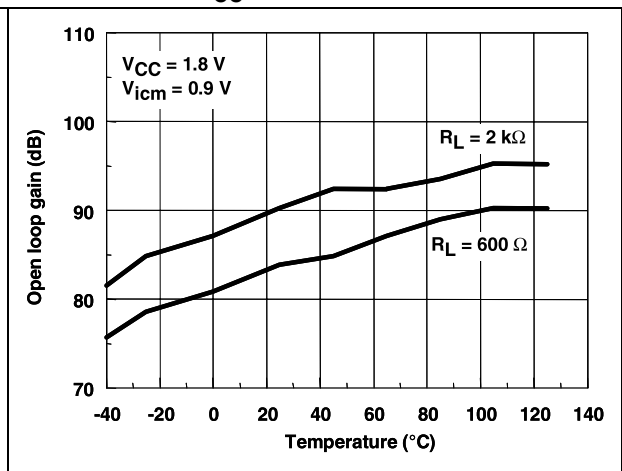

Figure 13. Open loop gain vs. temperature at $V_{CC} = 3\text{ V}$

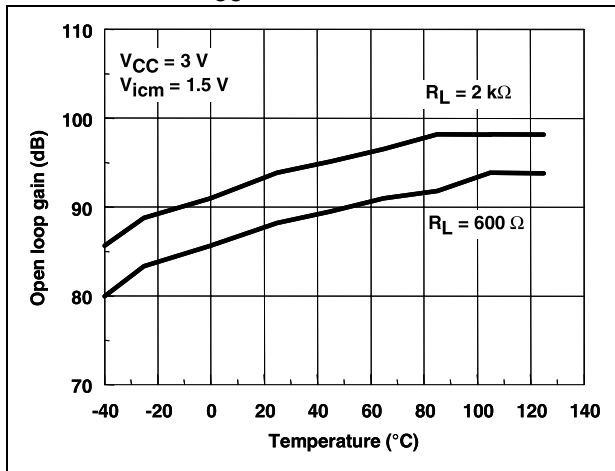

Figure 14. Open loop gain vs. temperature at $V_{CC} = 5\text{ V}$

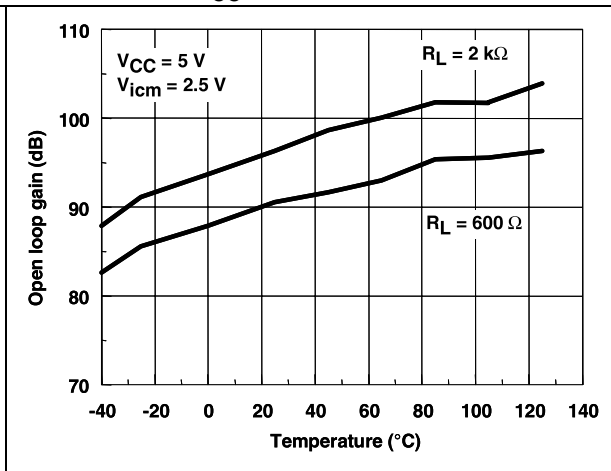

Figure 15. High level output voltage vs. temperature, $R_L = 600\ \Omega$

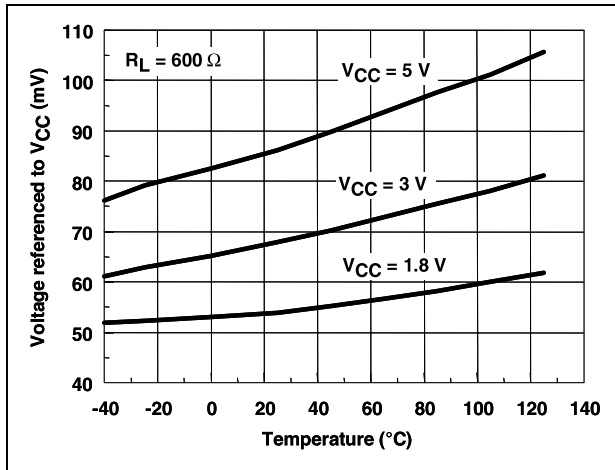

Figure 16. Low level output voltage vs. temperature, $R_L = 600\ \Omega$

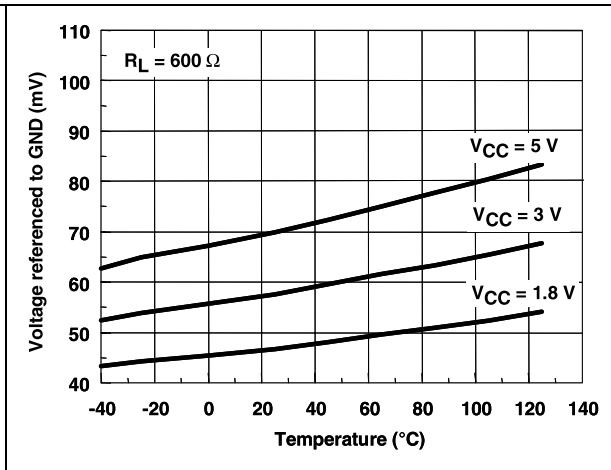

Figure 17. High level output voltage vs. temperature, $R_L = 2\text{ k}\Omega$

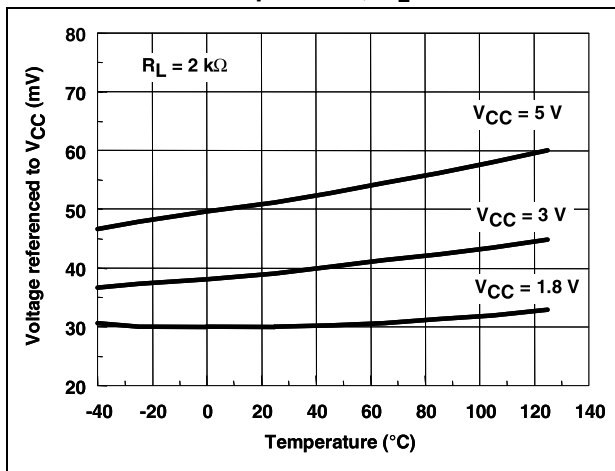

Figure 18. Low level output voltage vs. temperature, $R_L = 2\text{ k}\Omega$

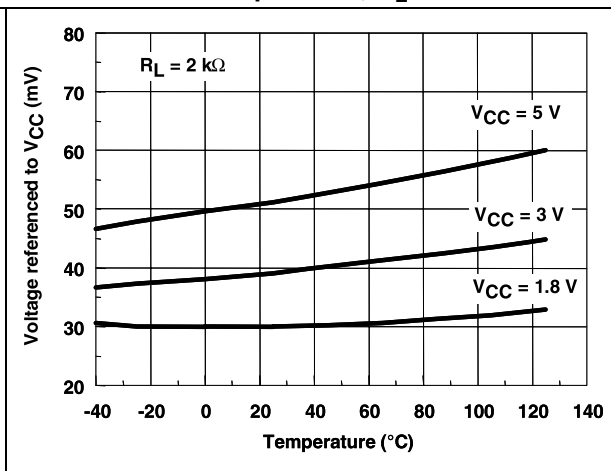

Figure 19. Output current vs. temperature at $V_{CC} = 1.8\text{ V}$

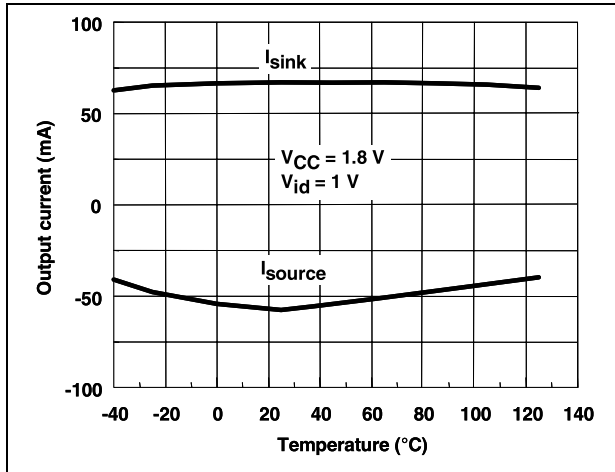

Figure 20. Output current vs. temperature at $V_{CC} = 3\text{ V}$

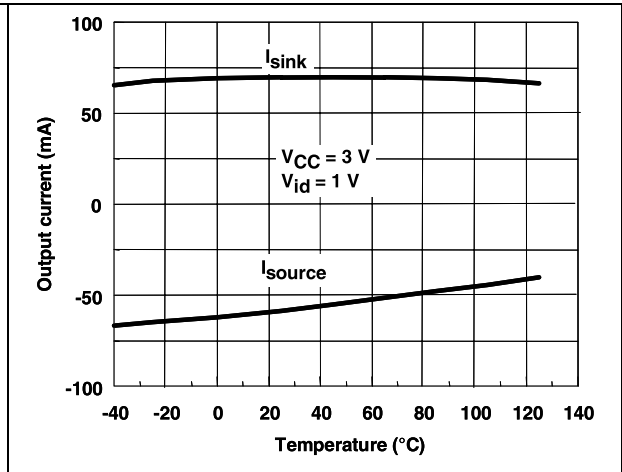

Figure 21. Output current vs. temperature at $V_{CC} = 5\text{ V}$

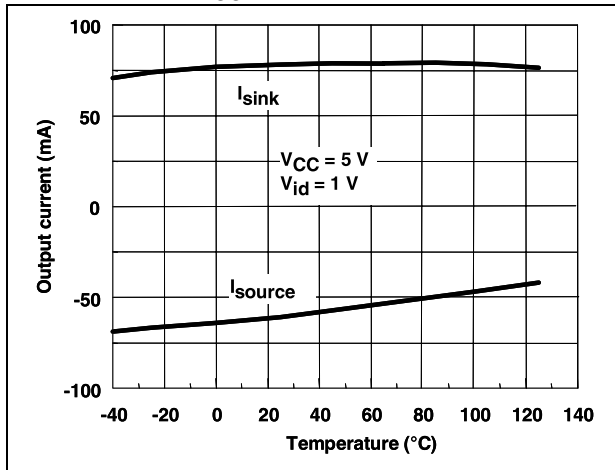

Figure 22. Output current vs. output voltage at $V_{CC} = 1.8\text{ V}$

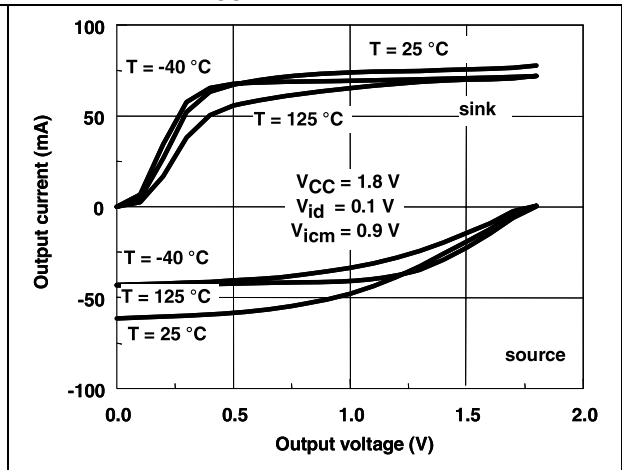

Figure 23. Output current vs. output voltage at $V_{CC} = 3\text{ V}$

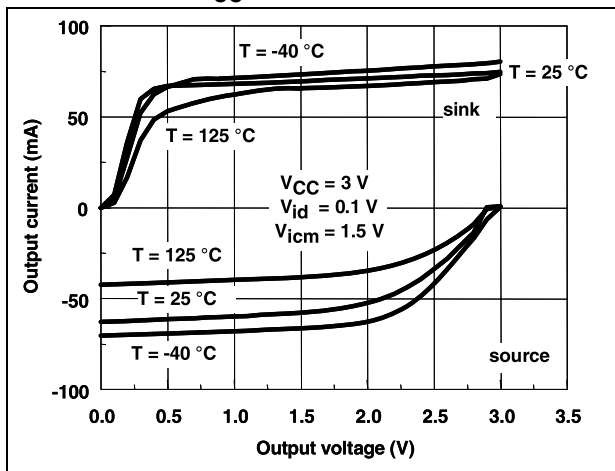

Figure 24. Output current vs. output voltage at $V_{CC} = 5\text{ V}$

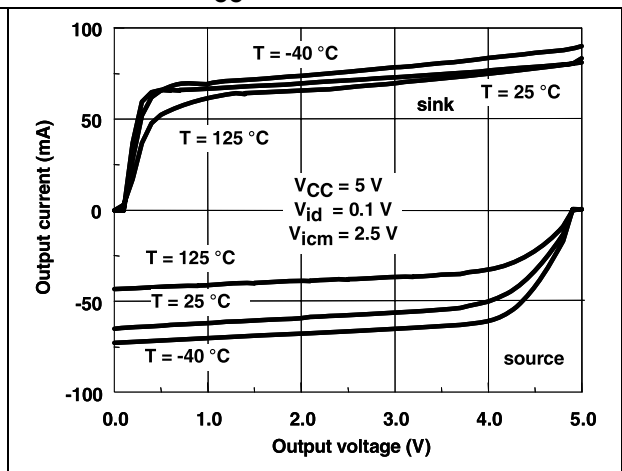

Figure 25. Gain and phase vs. frequency at $V_{CC} = 1.8\text{ V}$

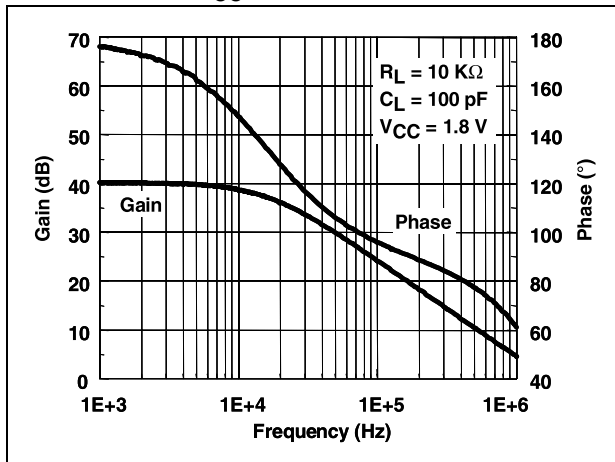

Figure 26. Gain and phase vs. frequency at $V_{CC} = 3\text{ V}$

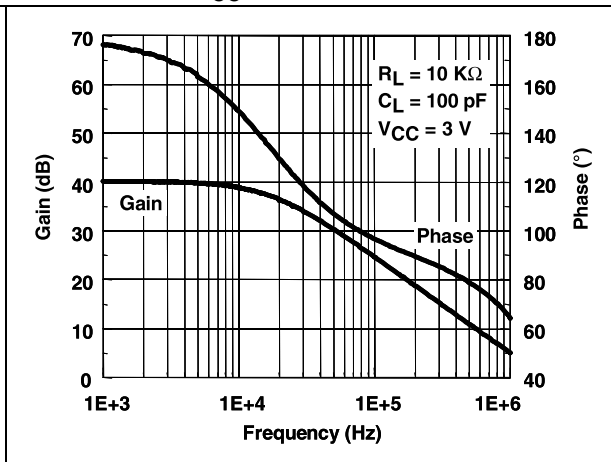

Figure 27. Gain and phase vs. frequency at $V_{CC} = 5\text{ V}$

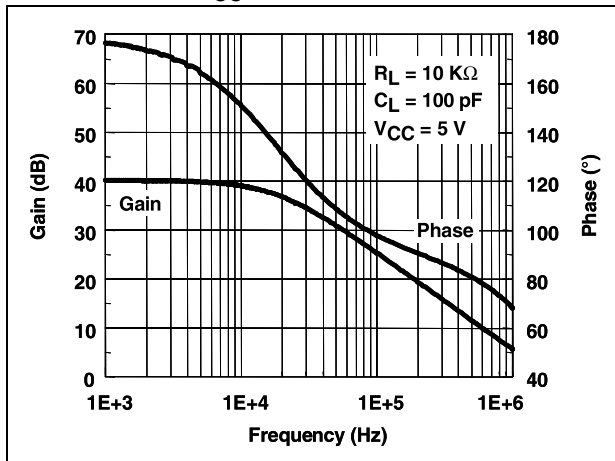

Figure 28. Gain bandwidth product vs. temperature

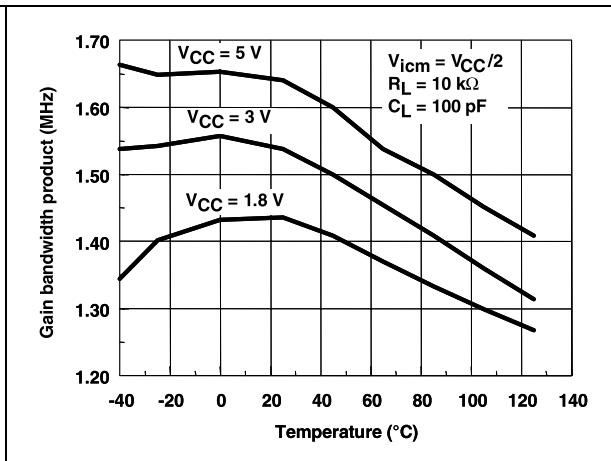

Figure 29. Gain bandwidth product vs. supply voltage

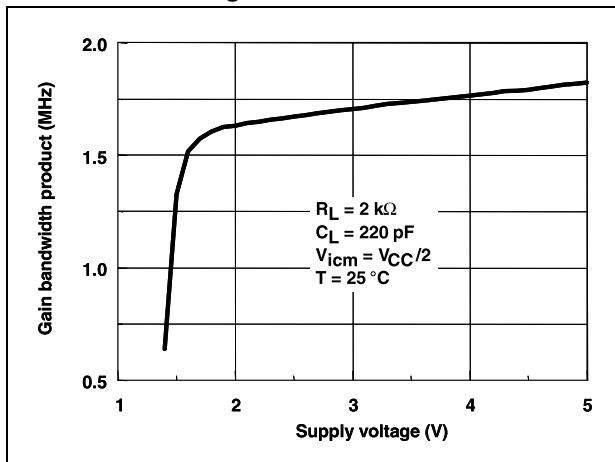

Figure 30. Slew rate vs. temperature at $V_{CC} = 1.8\text{ V}$

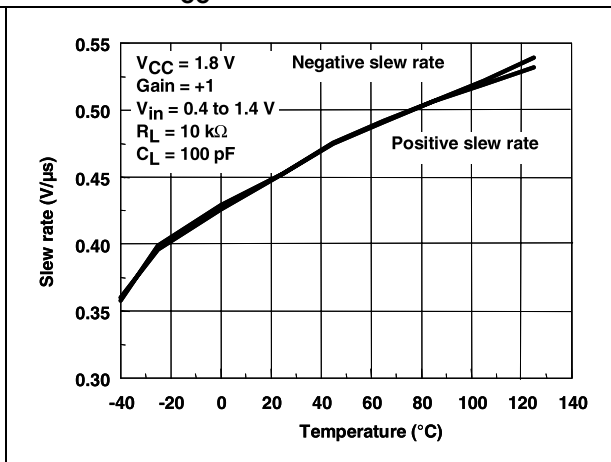

Figure 31. Slew rate vs. temperature at $V_{CC} = 3\text{ V}$

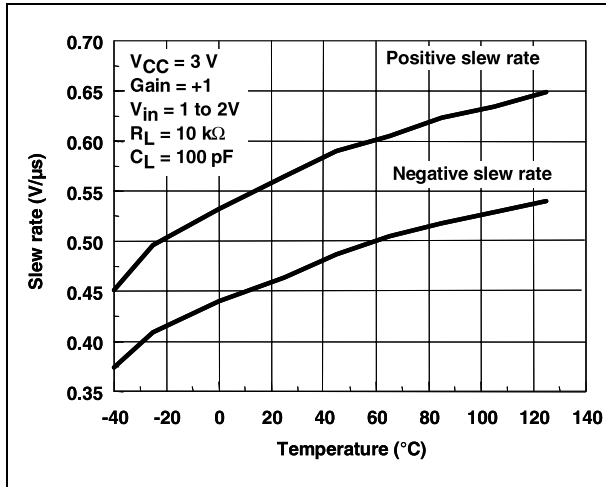

Figure 32. Slew rate vs. temperature at $V_{CC} = 5\text{ V}$

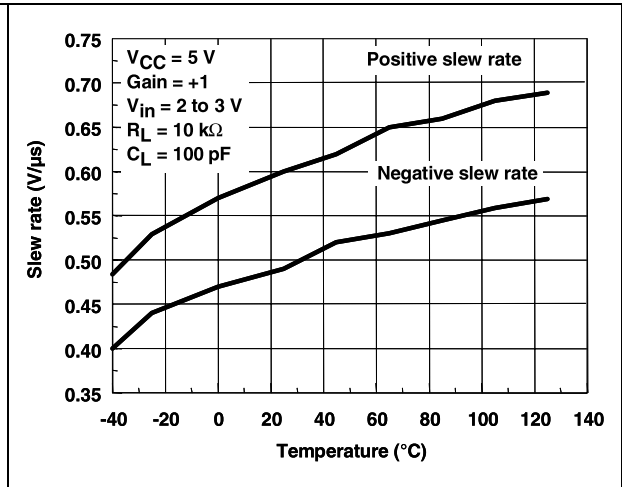

Figure 33. Phase margin vs. load capacitor

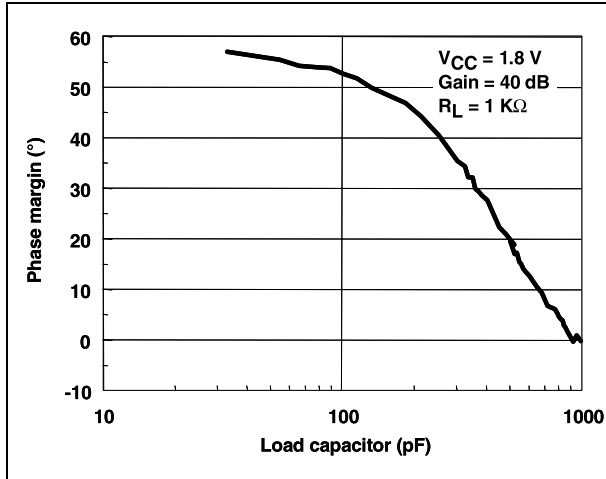

Figure 34. Phase margin vs. output current

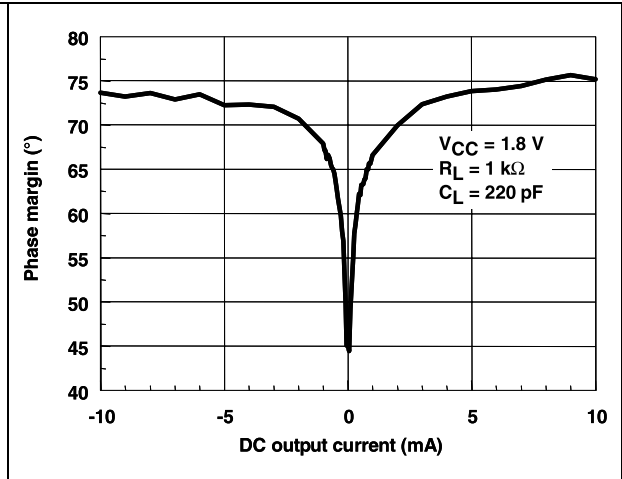

Figure 35. Gain margin vs. output current

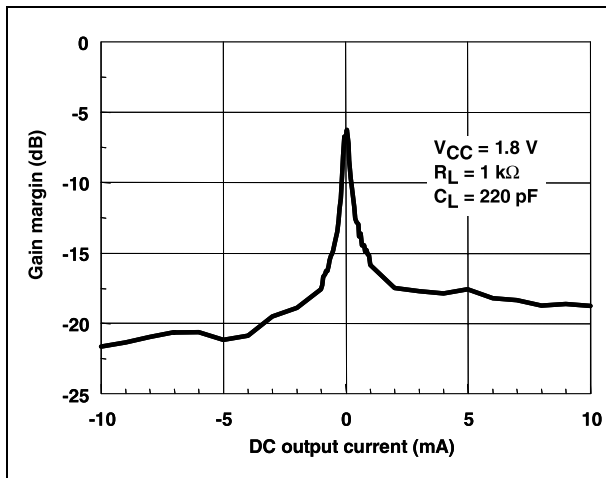

Figure 36. Equivalent input noise vs. frequency

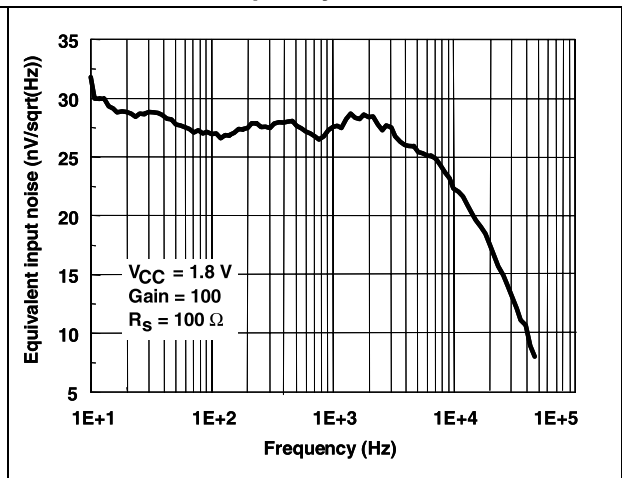

Figure 37. Distortion vs. output voltage at $V_{CC} = 1.8\text{ V}$

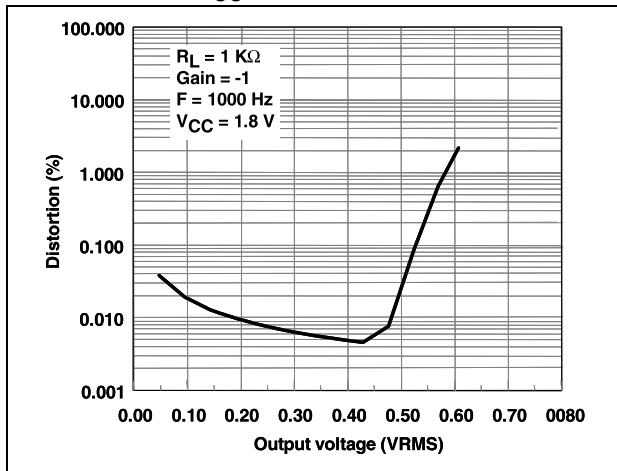

Figure 38. Distortion vs. output voltage at $V_{CC} = 3\text{ V}$

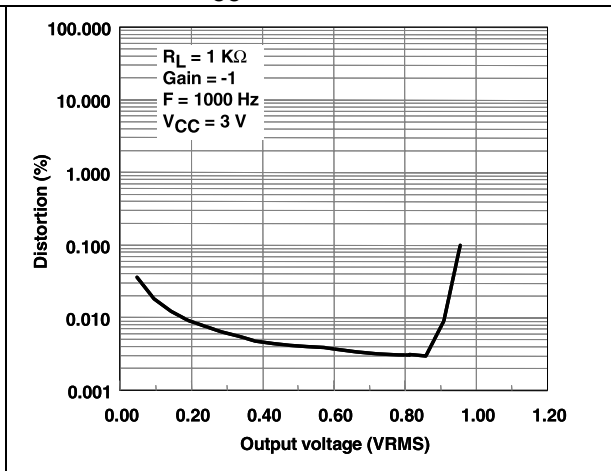

Figure 39. Distortion vs. output voltage at $V_{CC} = 5\text{ V}$

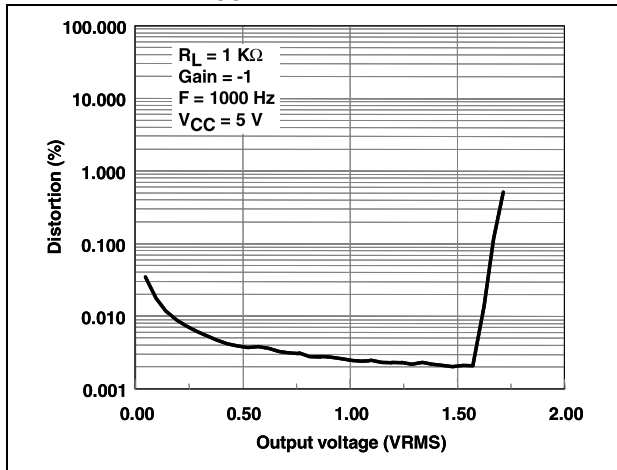

Figure 40. Distortion vs. output voltage at $V_{CC} = 2.7\text{ V}, R_L = 150\ \Omega$

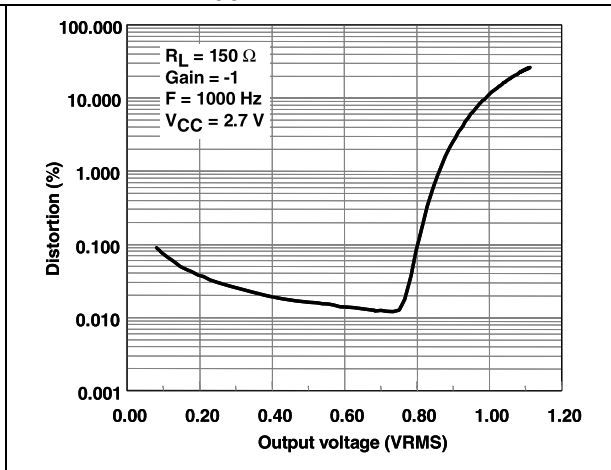

Figure 41. Distortion vs. output voltage at $V_{CC} = 2.7\text{ V}, R_L = 1500\ \Omega$

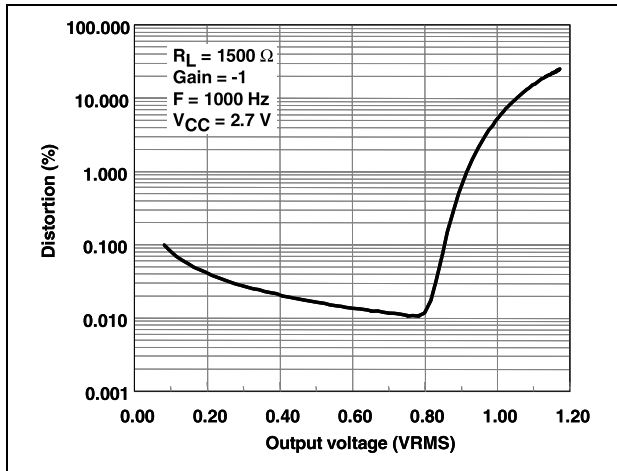

Figure 42. Distortion vs. output voltage at $V_{CC} = 2.7\text{ V}, R_L = 4700\ \Omega$

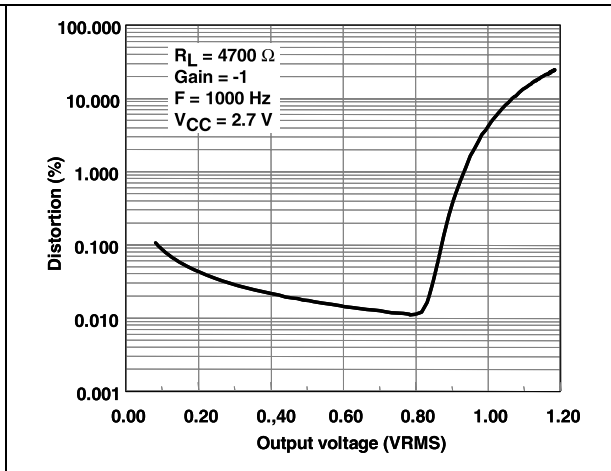

Figure 43. Distortion vs. frequency at $V_{CC} = 1.8\text{ V}$

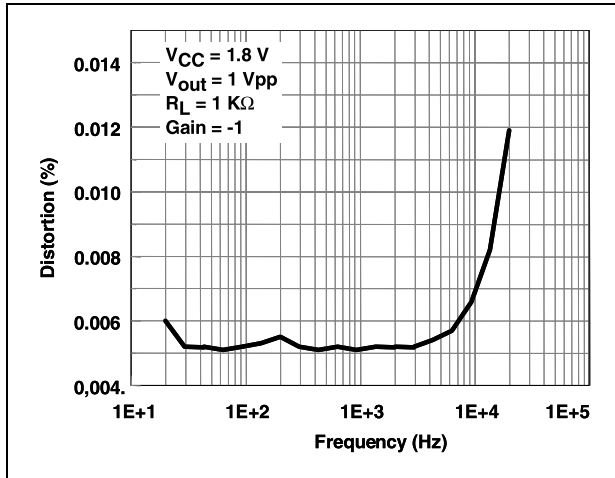

Figure 44. Distortion vs. frequency at $V_{CC} = 3\text{ V}$

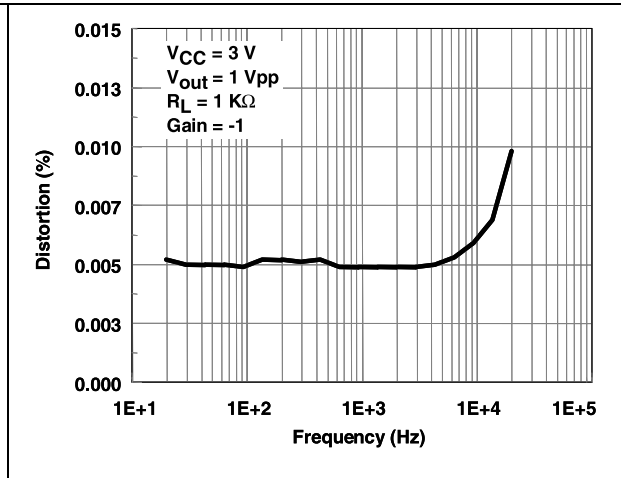

Figure 45. Distortion vs. frequency at $V_{CC} = 1.8\text{ V}$, $R_L = 32\ \Omega$

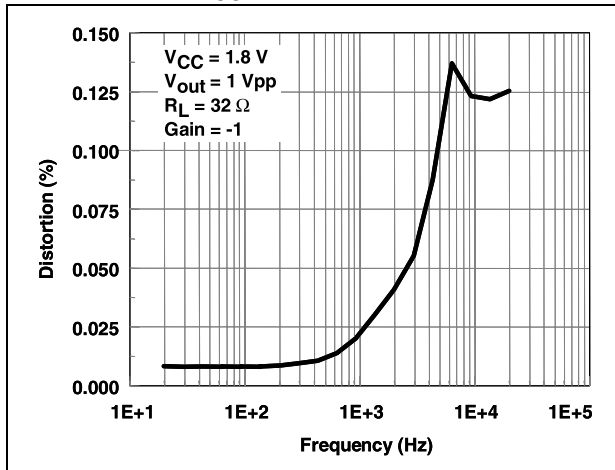

Figure 46. Distortion vs. frequency at $V_{CC} = 3\text{ V}$, $R_L = 32\ \Omega$

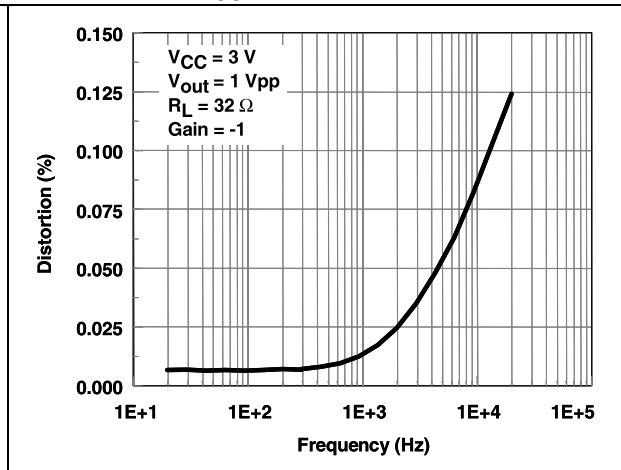

Figure 47. Output power vs. supply voltage

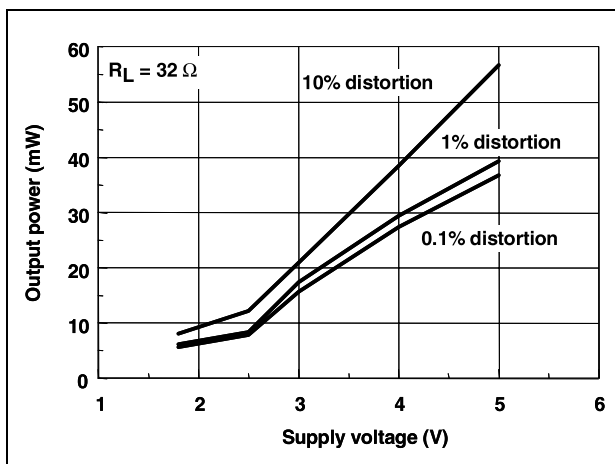
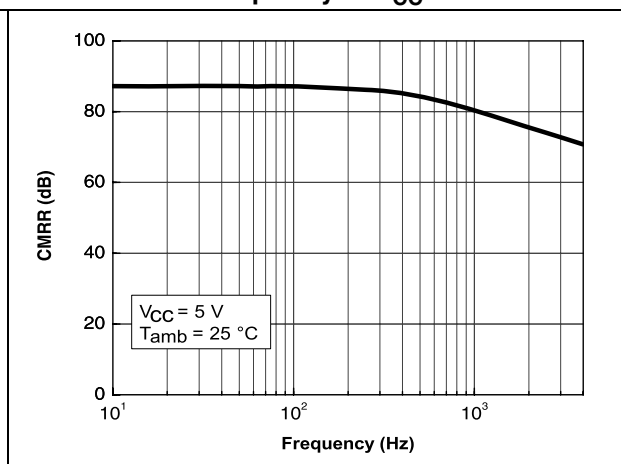

Figure 48. Common mode rejection ratio vs. frequency at $V_{CC} = 5\text{ V}$



3 Package information

In order to meet environmental requirements, ST offers these devices in different grades of ECOPACK® packages, depending on their level of environmental compliance. ECOPACK specifications, grade definitions and product status are available at: www.st.com. ECOPACK is an ST trademark.

3.1 SO-8 package information

Figure 49. SO-8 package outline

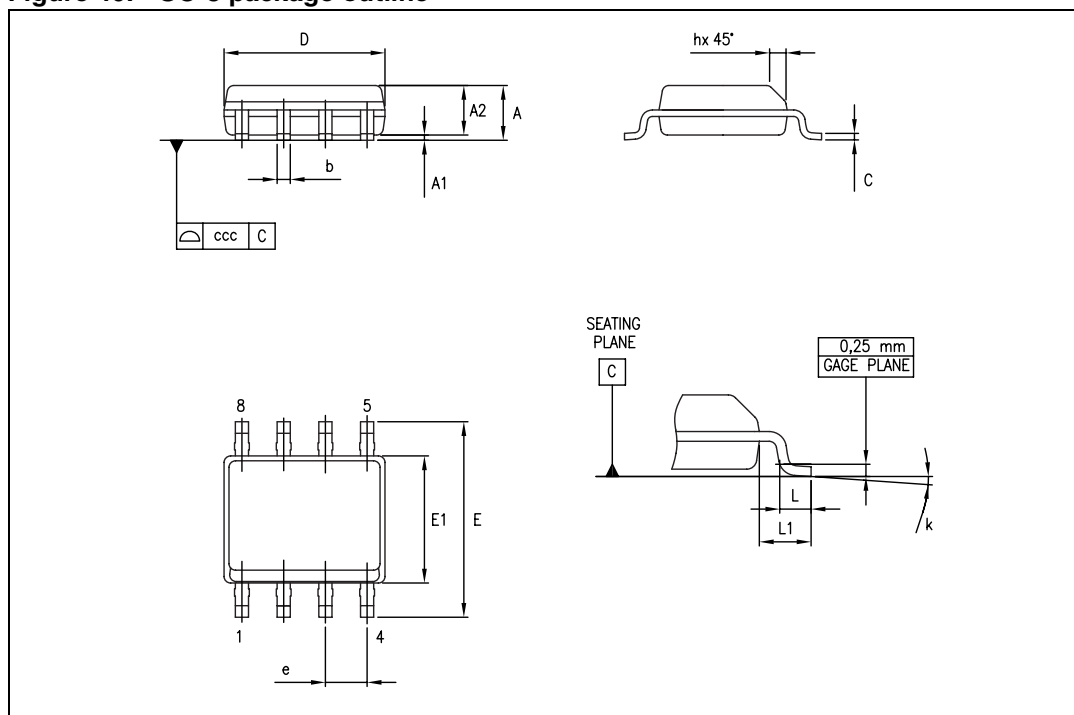

Table 7. SO-8 package mechanical data

Symbol	Dimensions					
	Millimeters			Inches		
	Min.	Typ.	Max.	Min.	Typ.	Max.
A			1.75			0.069
A1	0.10		0.25	0.004		0.010
A2	1.25			0.049		
b	0.28		0.48	0.011		0.019
c	0.17		0.23	0.007		0.010
D	4.80	4.90	5.00	0.189	0.193	0.197
E	5.80	6.00	6.20	0.228	0.236	0.244
E1	3.80	3.90	4.00	0.150	0.154	0.157
e		1.27			0.050	
h	0.25		0.50	0.010		0.020
L	0.40		1.27	0.016		0.050
L1		1.04			0.040	
k	1°		8°	1°		8°
ccc			0.10			0.004

3.2 TSSOP8 package information

Figure 50. TSSOP8 package outline

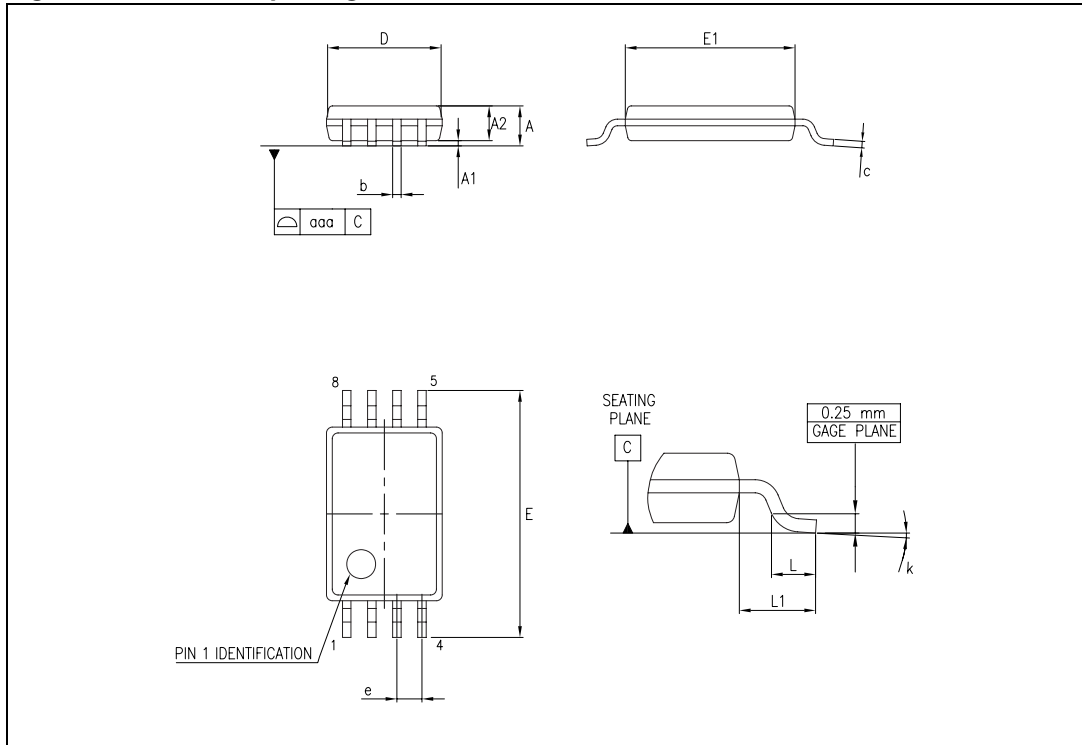

Table 8. TSSOP8 package mechanical data

Symbol	Dimensions					
	Millimeters			Inches		
	Min.	Typ.	Max.	Min.	Typ.	Max.
A			1.20			0.047
A1	0.05		0.15	0.002		0.006
A2	0.80	1.00	1.05	0.031	0.039	0.041
b	0.19		0.30	0.007		0.012
c	0.09		0.20	0.004		0.008
D	2.90	3.00	3.10	0.114	0.118	0.122
E	6.20	6.40	6.60	0.244	0.252	0.260
E1	4.30	4.40	4.50	0.169	0.173	0.177
e		0.65			0.0256	
k	0°		8°	0°		8°
L	0.45	0.60	0.75	0.018	0.024	0.030
L1		1			0.039	
aaa			0.10			0.004

3.3 MiniSO-8 package information

Figure 51. MiniSO-8 package outline

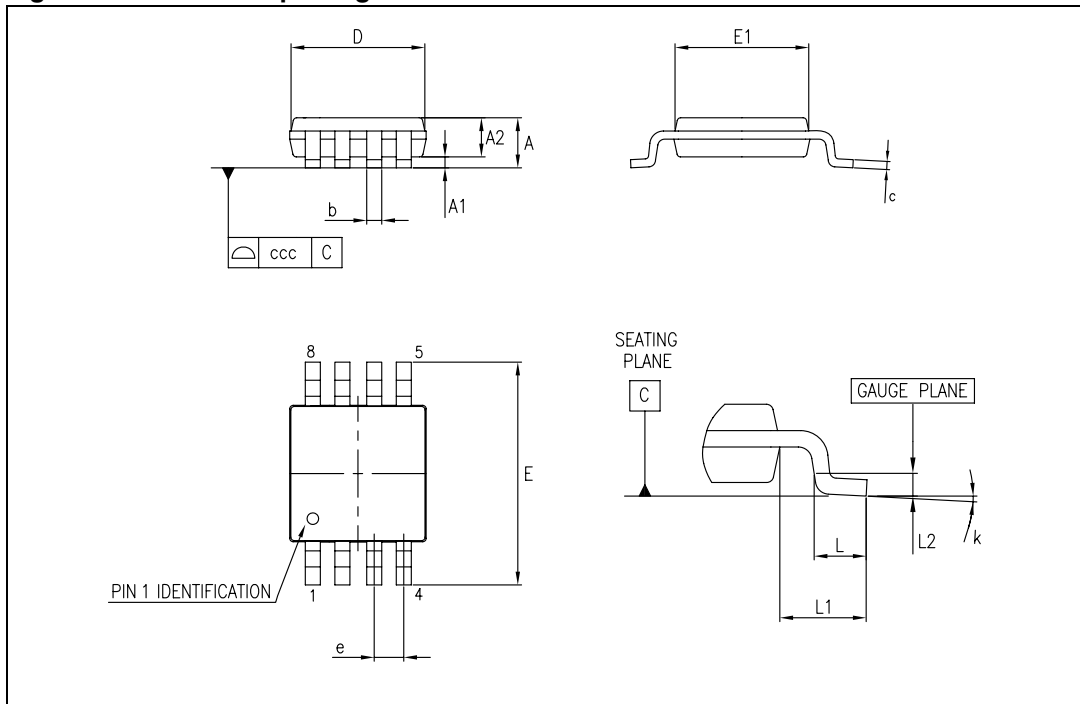

Table 9. MiniSO-8 package mechanical data

Symbol	Dimensions					
	Millimeters			Inches		
	Min.	Typ.	Max.	Min.	Typ.	Max.
A			1.1			0.043
A1	0		0.15	0		0.006
A2	0.75	0.85	0.95	0.030	0.033	0.037
b	0.22		0.40	0.009		0.016
c	0.08		0.23	0.003		0.009
D	2.80	3.00	3.20	0.11	0.118	0.126
E	4.65	4.90	5.15	0.183	0.193	0.203
E1	2.80	3.00	3.10	0.11	0.118	0.122
e		0.65			0.026	
L	0.40	0.60	0.80	0.016	0.024	0.031
L1		0.95			0.037	
L2		0.25			0.010	
k	0°		8°	0°		8°
ccc			0.10			0.004

3.4 SO-14 package information

Figure 52. SO-14 package outline

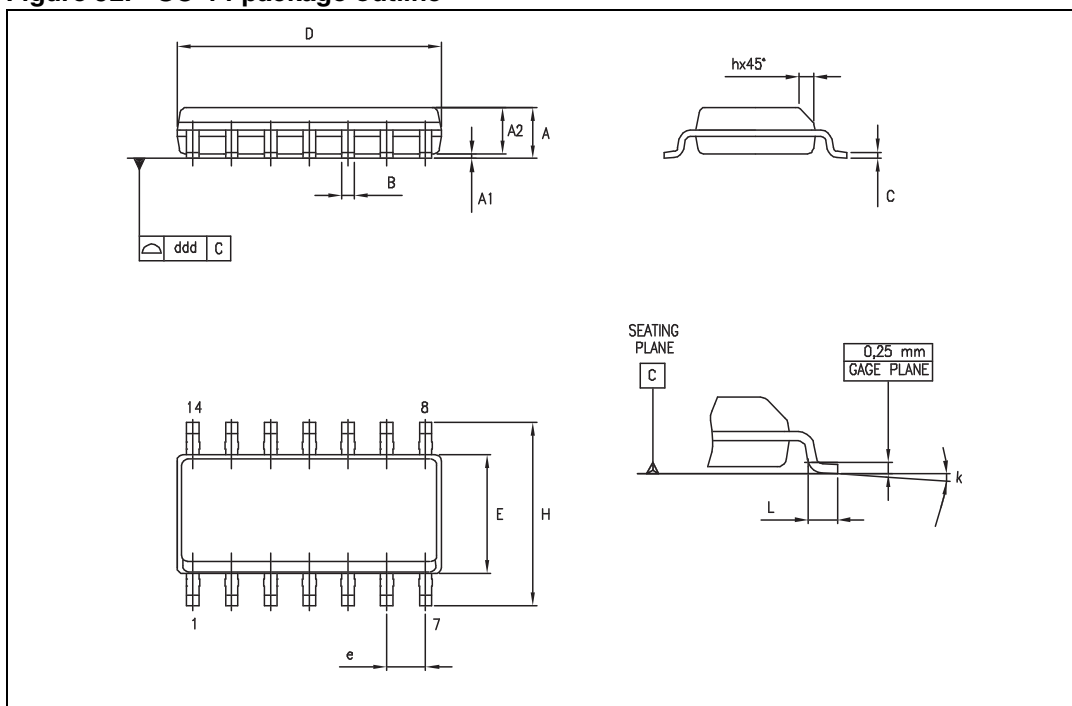

Table 10. SO-14 package mechanical data

Symbol	Dimensions					
	Millimeters			Inches		
	Min.	Typ.	Max.	Min.	Typ.	Max.
A	1.35		1.75	0.05		0.068
A1	0.10		0.25	0.004		0.009
A2	1.10		1.65	0.04		0.06
B	0.33		0.51	0.01		0.02
C	0.19		0.25	0.007		0.009
D	8.55		8.75	0.33		0.34
E	3.80		4.0	0.15		0.15
e		1.27			0.05	
H	5.80		6.20	0.22		0.24
h	0.25		0.50	0.009		0.02
L	0.40		1.27	0.015		0.05
k	8° (max.)					
ddd			0.10			0.004

3.5 TSSOP14 package information

Figure 53. TSSOP14 package outline

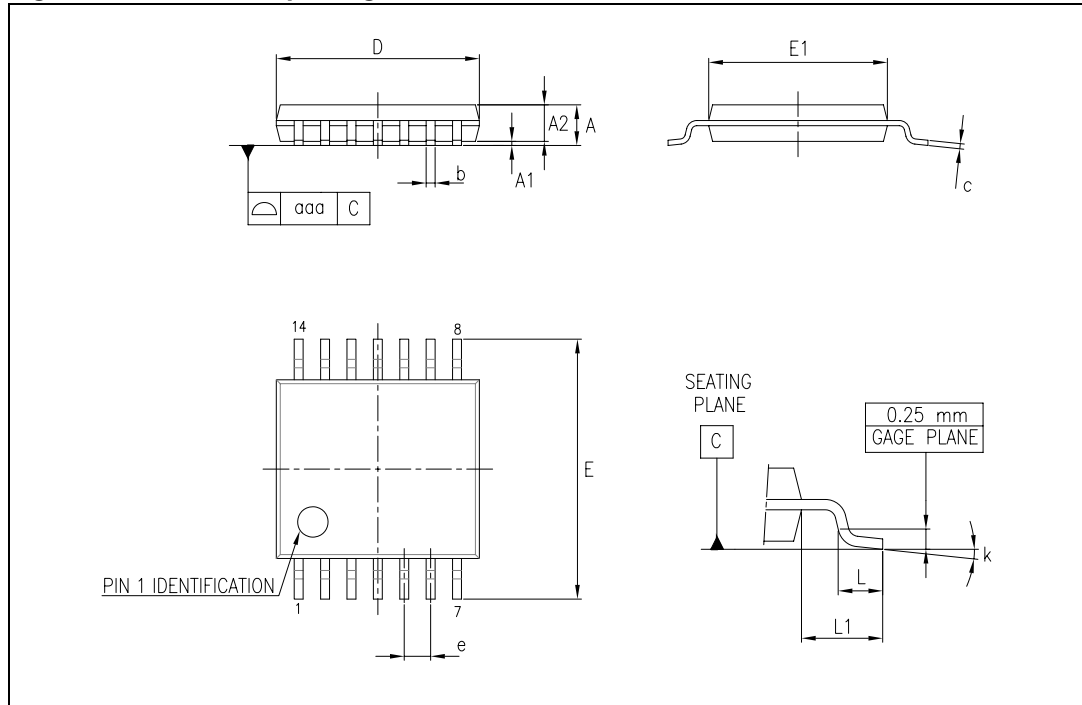

Table 11. TSSOP14 package mechanical data

Symbol	Dimensions					
	Millimeters			Inches		
	Min.	Typ.	Max.	Min.	Typ.	Max.
A			1.20			0.047
A1	0.05		0.15	0.002	0.004	0.006
A2	0.80	1.00	1.05	0.031	0.039	0.041
b	0.19		0.30	0.007		0.012
c	0.09		0.20	0.004		0.0089
D	4.90	5.00	5.10	0.193	0.197	0.201
E	6.20	6.40	6.60	0.244	0.252	0.260
E1	4.30	4.40	4.50	0.169	0.173	0.176
e		0.65			0.0256	
L	0.45	0.60	0.75	0.018	0.024	0.030
L1		1.00			0.039	
k	0°		8°	0°		8°
aaa			0.10			0.004

3.6 SOT23-5 package information

Figure 54. SOT23-5L package outline

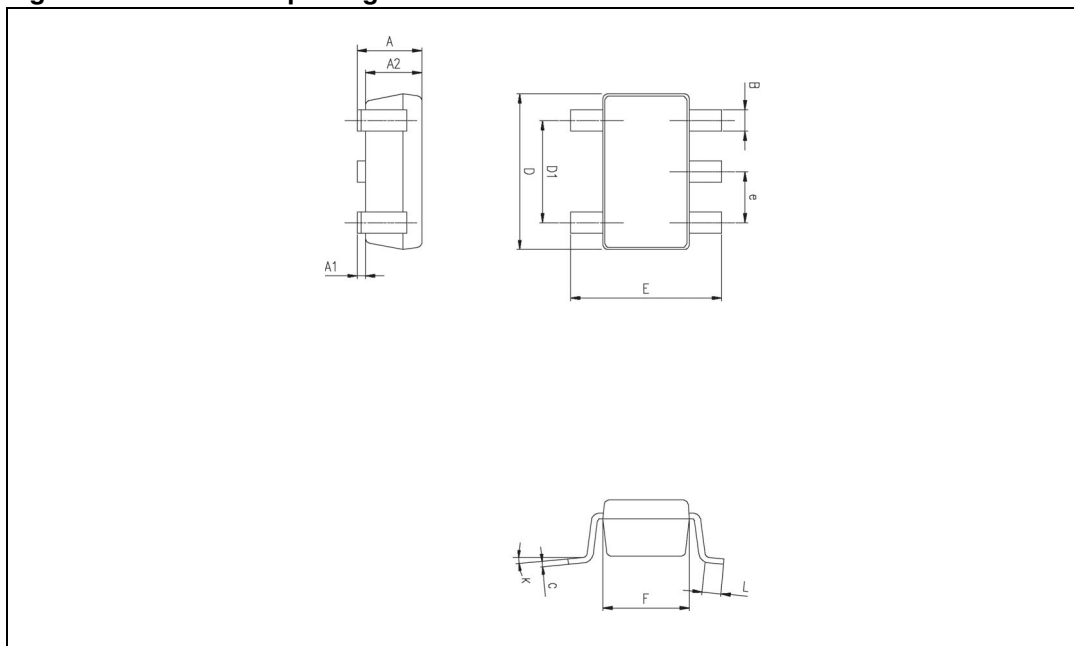

Table 12. SOT23-5L package mechanical data

Symbol	Dimensions					
	Millimeters			Inches		
	Min.	Typ.	Max.	Min.	Typ.	Max.
A	0.90	1.20	1.45	0.035	0.047	0.057
A1			0.15			0.006
A2	0.90	1.05	1.30	0.035	0.041	0.051
B	0.35	0.40	0.50	0.013	0.015	0.019
C	0.09	0.15	0.20	0.003	0.006	0.008
D	2.80	2.90	3.00	0.110	0.114	0.118
D1		1.90			0.075	
e		0.95			0.037	
E	2.60	2.80	3.00	0.102	0.110	0.118
F	1.50	1.60	1.75	0.059	0.063	0.069
L	0.10	0.35	0.60	0.004	0.013	0.023
K	0°		10°			

4 Ordering information

Table 13. Order codes

Order code	Temperature range	Package	Packaging	Marking
TS1871ID/IDT	-40 °C to +125 °C	SO-8	Tube or tape and reel	1871I
TS1871IAID/AIDT				1871AI
TS1871ILT		SOT23-5L	Tape and reel	K171
TS1871AILT				K172
TS1871IYLT ⁽¹⁾		SOT23-5L (automotive grade)	Tape and reel	K182
TS1871AIYLT ⁽¹⁾				K183
TS1872ID/IDT		SO-8	Tube or tape and reel	1872I
TS1872AID/AIDT				1872AI
TS1872IYDT ⁽¹⁾		SO-8 (automotive grade)	Tube or tape and reel	1872Y
TS1872AIYDT ⁽¹⁾				1872AY
TS1872IPT		TSSOP8	Tape and reel	1872I
TS1872AIPT				1872A
TS1872IYPT ⁽¹⁾		TSSOP8 (automotive grade)	Tape and reel	1872Y
TS1872AIYPT ⁽¹⁾				872AY
TS1872IST		MiniSO-8	Tape and reel	K171
TS1872AIST				K172
TS1874ID/IDT		SO-14	Tube or tape and reel	1874I
TS1874AID/AIDT				1874AI
TS1874IYDT ⁽¹⁾		SO-14 (automotive grade)	Tape and reel	TS1874Y
TS1874AIYDT ⁽¹⁾				TS1874AY
TS1874IPT	TSSOP14	Tape and reel	1874I	
TS1874AIPT			1874AI	
TS1874IYPT ⁽¹⁾	TSSOP14 (automotive grade)	Tape and reel	TS1874Y	
TS1874AIYPT ⁽¹⁾			TS1874AY	

1. Qualified and characterized according to AEC Q100 and Q003 or equivalent, advanced screening according to AEC Q001 and Q 002 or equivalent.

5 Revision history

Table 14. Document revision history

Date	Revision	Changes
01-Apr-2002	1	First release.
02-Jan-2005	2	Modifications on AMR Table 2 on page 3 (explanation of V_{id} and V_i limits).
21-May-2007	3	Added limits over temperature range in Table 4 on page 5 , Table 5 on page 6 , Table 6 on page 7 . Added SVR in Table 6 (SVR parameter removed from Table 4 and Table 5). Added equivalent input voltage noise in Table 4 , Table 5 , and Table 6 . Added R_{thjc} values in Table 2 . Added automotive grade part numbers to order codes table. Moved order codes table to Section 4 on page 23 . Updated format of package information.
17-Jan-2008	4	Updated footnote for automotive grade order codes in Table 13 .
12-Mar-2010	5	Updated document format. Modified headings, added root part number TS187xA and added Table 1: Device summary on cover page. Corrected typical values for A_{Vd} , I_{source} , I_{sink} and V_{ol} in Table 4 , Table 5 and Table 6 . Added Figure 48: Common mode rejection ratio vs. frequency at $V_{CC} = 5 V$. Updated package information in Chapter 3 . Removed order codes for SO-8 automotive grade packages (TS1871IYDT and TS1871AIYDT) from Table 13 . Removed order codes for DIP package from Table 13 .
06-Jul-2012	6	Updated Table 13: Order codes .
19-Nov-2012	7	Updated Features (added MiniSO-8, SO-8, SO-14, TSSOP8, and TSSOP14 package). Updated titles of Table 5 and Table 6 (replaced V_{DD} by V_{CC}). Updated TS1871IYLT, TS1871AIYLT, TS1872IYDT, TS1872AIYDT, TS1874IYDT, TS1874AIYDT, TS1874IYPT, TS1872IYPT, TS1872AIYPT, and TS1874AIYPT order code in Table 13 (status qualified). Updated packaging for TS1874IYDT and TS1874AIYDT order code (indicated only tape and reel) in Table 13 . Added note 1. below Table 13 . Minor corrections throughout document.