

CMOS Programmable Low Power Single Operational Amplifier

- Offset null capability (by external compensation)
- Dynamic characteristics adjustable I_{SET}
- Consumption current and dynamic parameters are stable regarding the voltage power supply variations
- Output voltage can swing to ground
- Very large I_{SET} range
- Stable and low offset voltage
- Three input offset voltage selections

Description

The TS271 is a low cost, low power single operational amplifier designed to operate with single or dual supplies. This operational amplifier uses the ST silicon gate CMOS process giving it an excellent consumption-speed ratio. This amplifier is ideally suited for low consumption applications.

The power supply is externally programmable with a resistor connected between pins 8 and 4. It allows to choose the best consumption-speed ratio and supply current can be minimized according to the required speed. This device is specified for the following I_{SET} current values: 1.5 μ A, 25 μ A, 130 μ A.

This CMOS amplifier offers very high input impedance and extremely low input currents. The major advantage versus JFET devices is the very low input currents drift with temperature see [Figure 8](#), [Figure 19](#), [Figure 30](#).

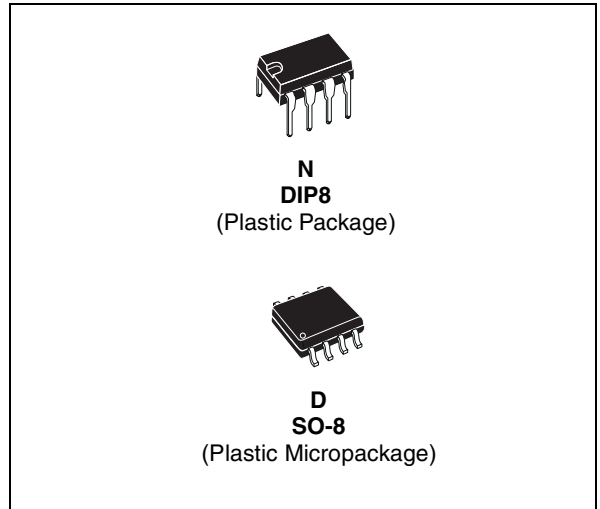

Pin Connections (top view)

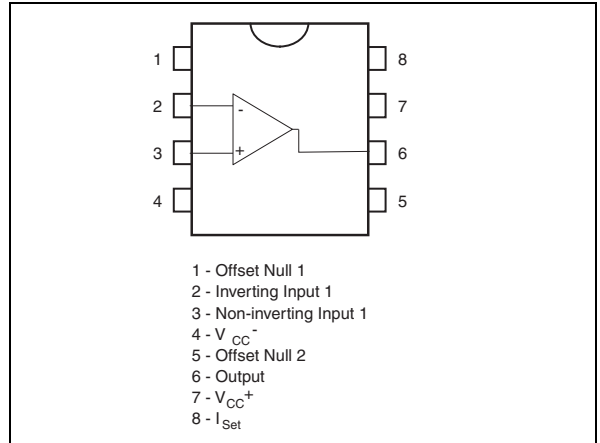

Order Codes

| Part Number | Temperature Range | Package | Packaging |
|-------------------------------|-------------------|---------|----------------------|
| TS271CN/ACN | 0°C, +70°C | DIP | Tube |
| TS271CD/CDT/ACD/ACDT | | SO | Tube and Tape & Reel |
| TS271IN/AIN/ | -40°C, +125°C | DIP | Tube |
| TS271ID/IDT/AID/AIDT/BID/BIDT | | SO | Tube and Tape & Reel |
| TS271BMD | -55°C, +125°C | SO | Tube |

1 Block Diagram

Figure 1. Application block diagram

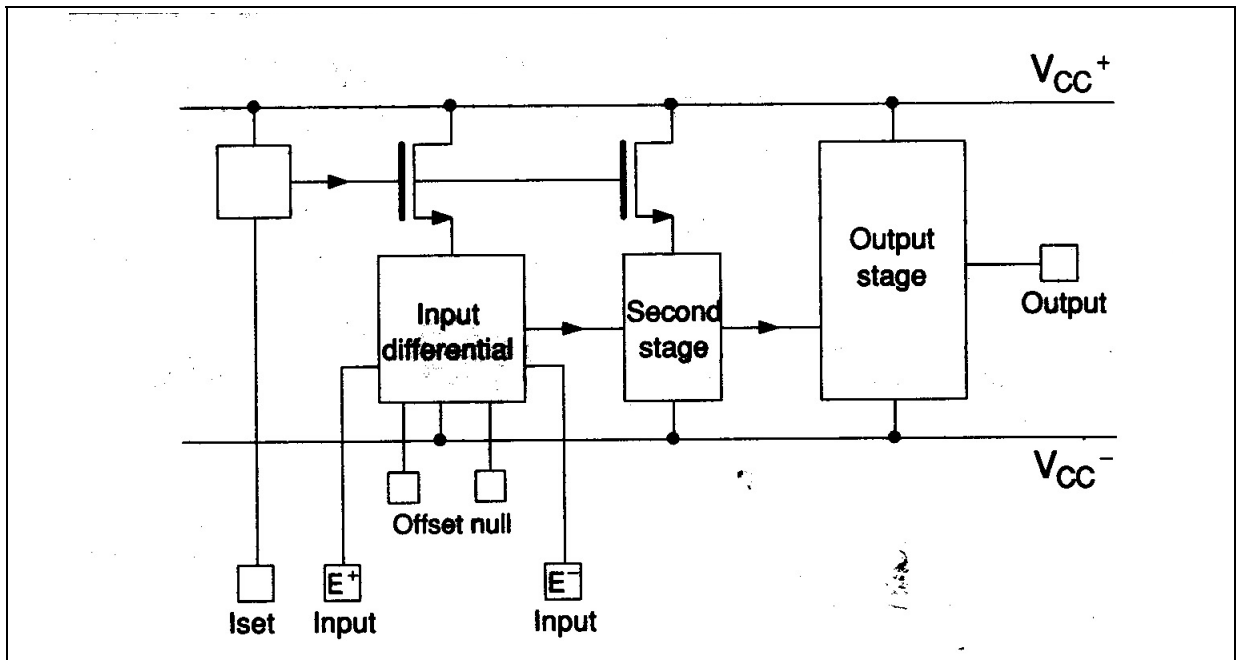

2 Absolute Maximum Ratings

Table 1. Key parameters and their absolute maximum ratings

| Symbol | Parameter | TS271C/AC/BC | TS271I/AI/BI | TS271M/AM/BM | Unit |
|------------|---|--------------|--------------|--------------|------|
| V_{CC}^+ | Supply Voltage ¹ | 18 | | | V |
| V_{id} | Differential Input Voltage ² | ±18 | | | V |
| V_i | Input Voltage ³ | -0.3 to 18 | | | V |
| I_o | Output Current for $V_{CC}^+ \geq 15V$ | ±30 | | | mA |
| I_{in} | Input Current | ±5 | | | mA |
| T_{oper} | Operating Free-Air Temperature Range | 0 to +70 | -40 to +125 | -55 to +125 | °C |
| T_{stg} | Storage Temperature Range | -65 to +150 | | | °C |

- 1) All values, except differential voltage are with respect to network ground terminal.
- 2) Differential voltages are the non-inverting input terminal with respect to the inverting input terminal.
- 3) The magnitude of the input and the output voltages must never exceed the magnitude of the positive supply voltage.

Table 2. Operating conditions

| Symbol | Parameter | Value | Unit |
|------------|---------------------------------|-----------------------|------|
| V_{CC}^+ | Supply Voltage | 3 to 16 | V |
| V_{icm} | Common Mode Input Voltage Range | 0 to $V_{CC}^+ - 1.5$ | V |

Figure 2. Schematic Diagram

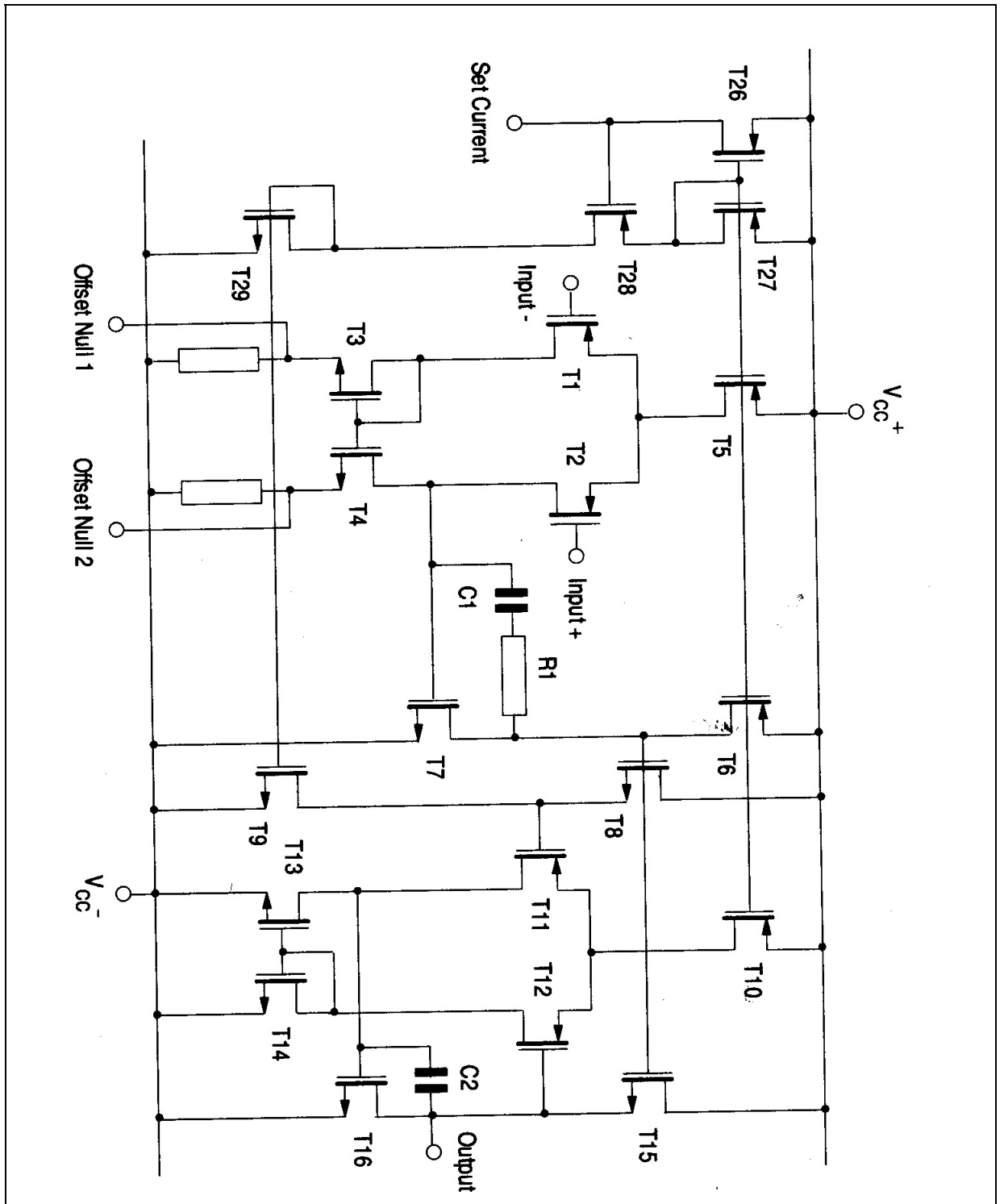

Figure 3. Offset voltage null circuit

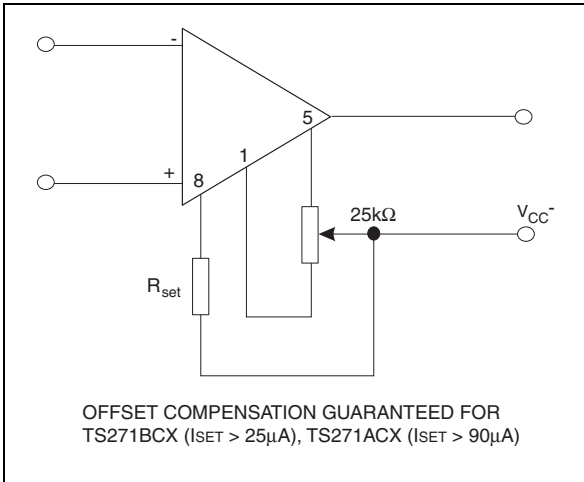

Figure 5. Resistor biasing

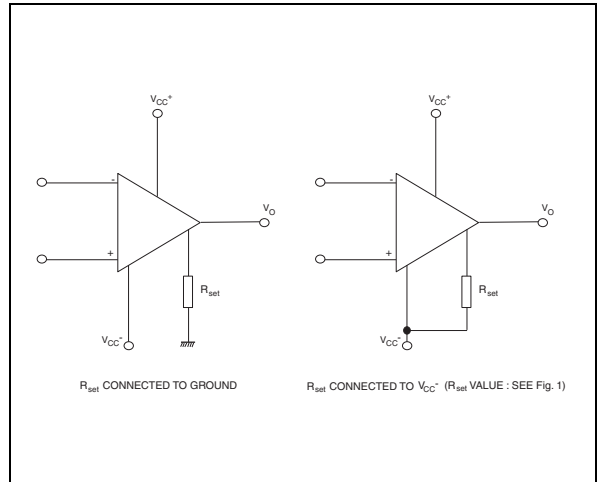

Figure 4. Offset voltage null circuit

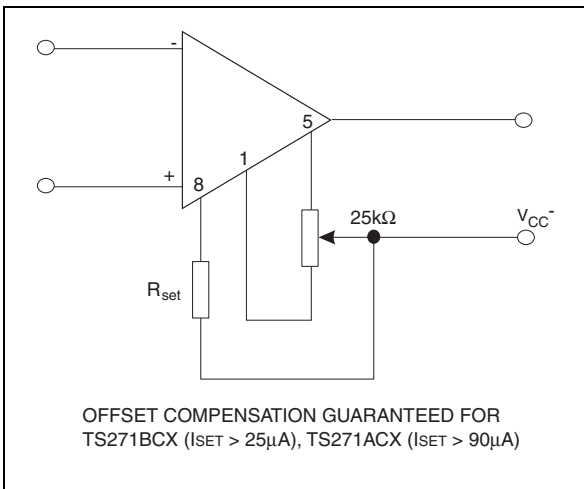
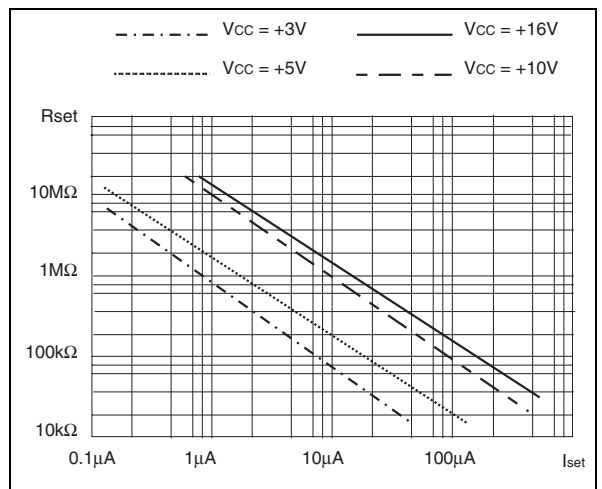

Figure 6. Rset connected to Vcc-



3 Electrical Characteristics

Table 3. for $I_{SET} = 1.5\mu A$ - $V_{CC}^+ = +10V$, $V_{CC}^- = 0V$, $T_{amb} = +25^\circ C$ (unless otherwise specified)

| Symbol | Parameter | TS271C/AC/BC | | | TS271I/AI/BI TS271M/AM/BM | | | Unit |
|------------|---|--------------|--------------------|--------------------------------|------------------------------|--------------------|----------------------------------|------------------------|
| | | Min. | Typ. | Max. | Min. | Typ. | Max. | |
| V_{io} | Input Offset Voltage $V_O = 1.4V$, $V_{ic} = 0V$ TS271C/I/M TS271AC/AI/AM TS271BC/BI/BM $T_{min} \leq T_{amb} \leq T_{max}$ TS271C/I/M TS271AC/AI/AM TS271BC/BI/BM | | 1.1 0.9 0.25 | 10 5 2 12 6.5 3 | | 1.1 0.9 0.25 | 10 5 2 12 6.5 3.5 | mV |
| DV_{io} | Input Offset Voltage Drift | | 2 | | | 2 | | $\mu V/^\circ C$ |
| I_{io} | Input Offset Current note 1 $V_{ic} = 5V$, $V_O = 5V$ $T_{min} \leq T_{amb} \leq T_{max}$ | | 1 | 100 | | 1 | 200 | pA |
| I_{ib} | Input Bias Current - see note 1 $V_{ic} = 5V$, $V_O = 5V$ $T_{min} \leq T_{amb} \leq T_{max}$ | | 1 | 150 | | 1 | 300 | pA |
| V_{OH} | High Level Output Voltage $V_{id} = 100mV$, $R_L = 1M\Omega$ $T_{min} \leq T_{amb} \leq T_{max}$ | 8.8 8.7 | 9 | | 8.8 8.6 | 9 | | V |
| V_{OL} | Low Level Output Voltage $V_{id} = -100mV$ | | | 50 | | | 50 | mV |
| A_{vd} | Large Signal Voltage Gain $V_{ic} = 5V$, $R_L = 1M\Omega$, $V_o = 1V$ to $6V$ $T_{min} \leq T_{amb} \leq T_{max}$ | 30 20 | 100 | | 30 20 | 100 | | V/mV |
| GBP | Gain Bandwidth Product $A_v = 40dB$, $R_L = 1M\Omega$, $C_L = 100pF$, $f_{in} = 100kHz$ | | 0.1 | | | 0.1 | | MHz |
| CMR | Common Mode Rejection Ratio $V_{ic} = 1V$ to $7.4V$, $V_o = 1.4V$ | 60 | 80 | | 60 | 80 | | dB |
| SVR | Supply Voltage Rejection Ratio $V_{CC}^+ = 5V$ to $10V$, $V_o = 1.4V$ | 60 | 80 | | 60 | 80 | | dB |
| I_{CC} | Supply Current (per amplifier) $A_v = 1$, no load, $V_o = 5V$ $T_{min} \leq T_{amb} \leq T_{max}$ | | 10 | 15 17 | | 10 | 15 18 | μA |
| I_o | Output Short Circuit Current $V_o = 0V$, $V_{id} = 100mV$ | | 60 | | | 60 | | mA |
| I_{sink} | Output Sink Current $V_o = V_{CC}$, $V_{id} = -100mV$ | | 45 | | | 45 | | mA |
| SR | Slew Rate at Unity Gain $R_L = 1M\Omega$, $C_L = 100pF$, $V_i = 3$ to $7V$ | | 0.04 | | | 0.04 | | $V/\mu s$ |
| ϕ_m | Phase Margin at Unity Gain $A_v = 40dB$, $R_L = 1M\Omega$ $C_L = 10pF$ $C_L = 100pF$ | | 35 10 | | | 35 10 | | Degrees |
| K_{OV} | Overshoot Factor $A_v = 40dB$, $R_L = 1M\Omega$ $C_L = 10pF$ $C_L = 100pF$ | | 40 70 | | | 40 70 | | % |
| e_n | Equivalent Input Noise Voltage $f = 1kHz$, $R_s = 100\Omega$ | | 30 | | | 30 | | $\frac{nV}{\sqrt{Hz}}$ |

1) Maximum values including unavoidable inaccuracies of the industrial test.

Typical characteristics for $I_{SET} = 1.5\mu A$

Figure 7. Supply current versus supply voltage

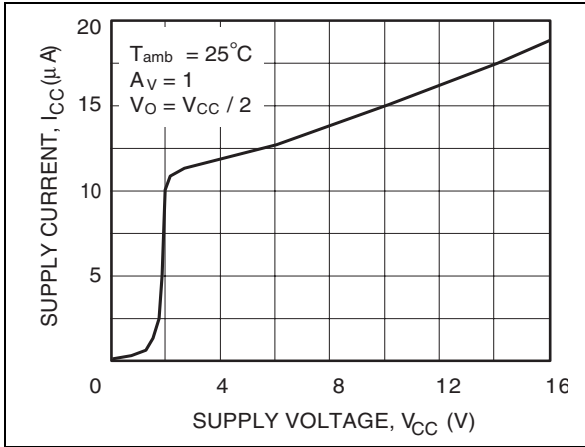

Figure 8. Input bias current versus free air temperature

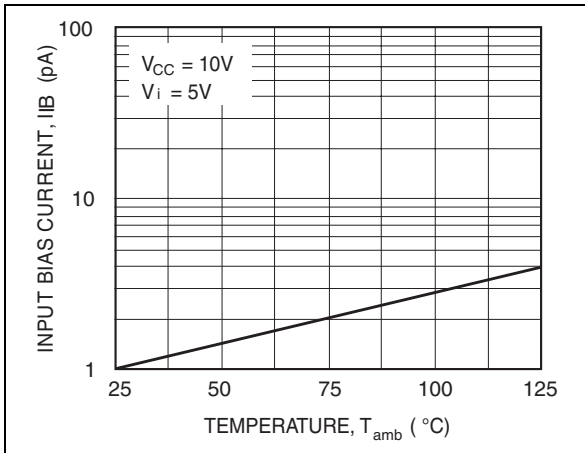

Figure 9. High level output voltage versus high level output current

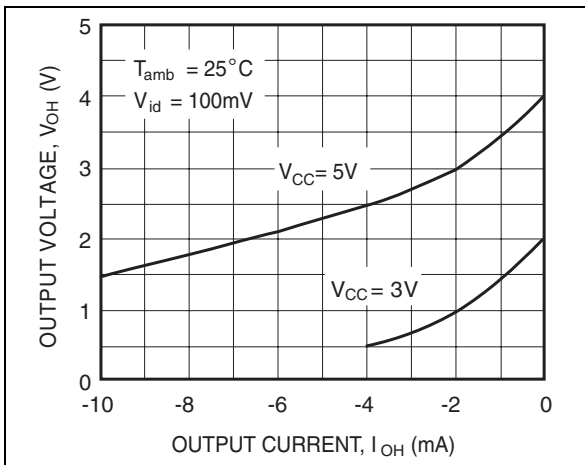

Figure 10. High level output voltage versus high level output current

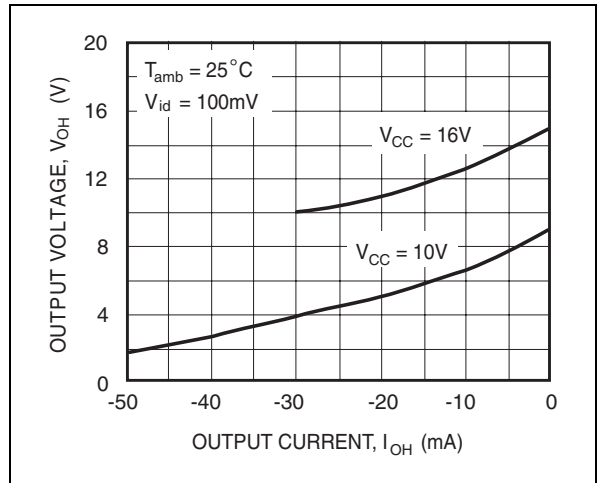

Figure 11. Low level output voltage versus low level output current

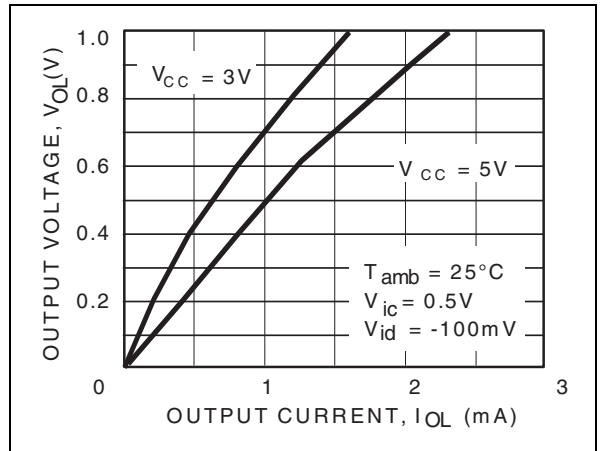

Figure 12. Low level output voltage versus low level output current

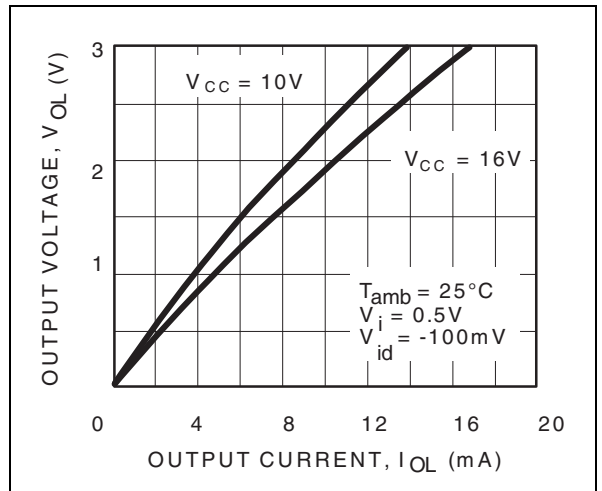

Figure 13. Open loop frequency response and phase shift

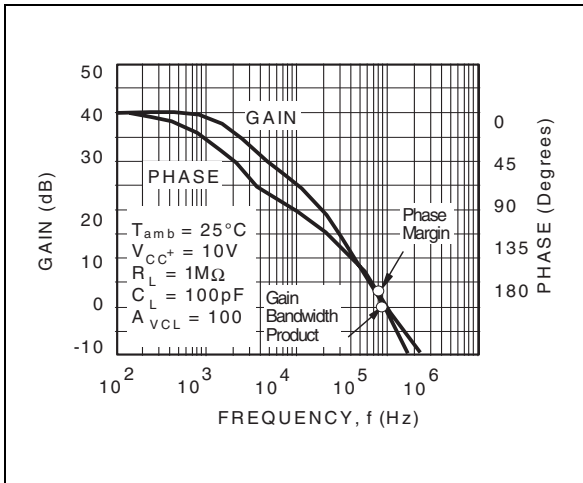

Figure 16. Phase margin versus capacitive load

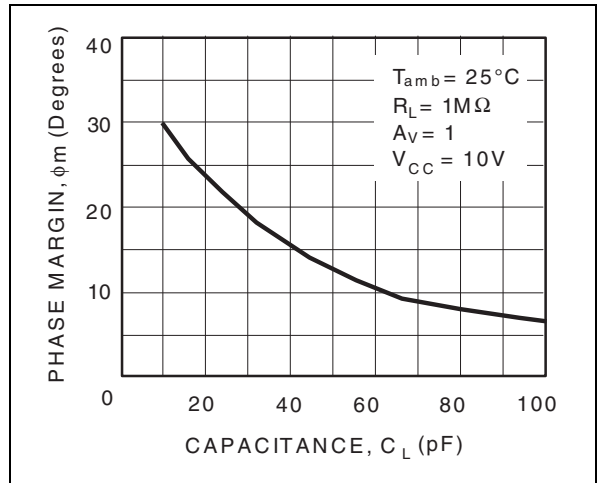

Figure 14. Gain bandwidth product versus supply voltage

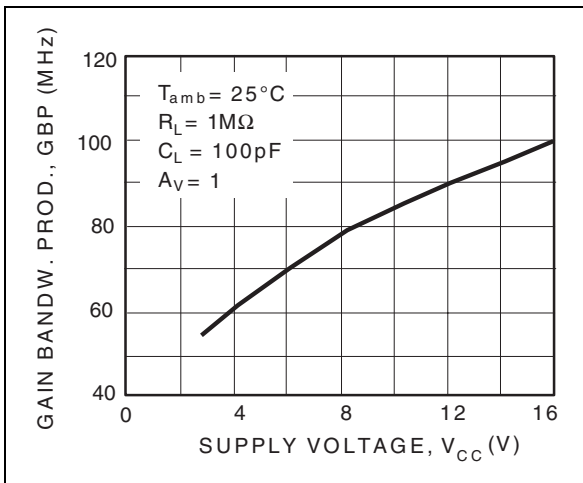

Figure 17. Slew rate versus supply voltage

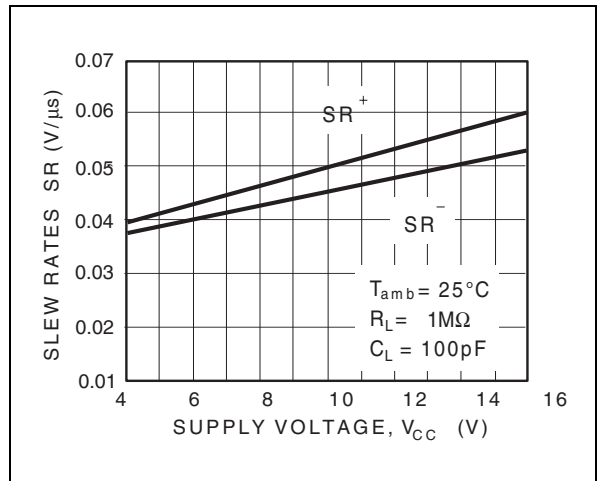
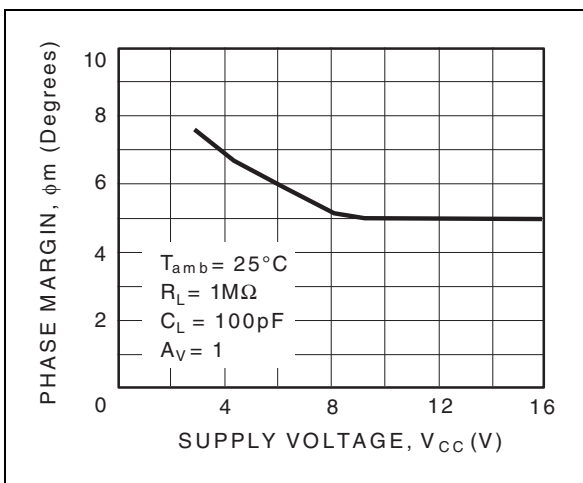

Figure 15. Phase margin versus supply voltage



4 Electrical Characteristics

Table 4. for $I_{SET} = 25\mu A$ - $V_{CC}^+ = +10V$, $V_{CC}^- = 0V$, $T_{amb} = +25^\circ C$ (unless otherwise specified)

| Symbol | Parameter | TS271C/AC/BC | | | TS271I/AI/BI TS271M/AM/BM | | | Unit |
|------------|---|--------------|--------------------|--------------------------------|------------------------------|--------------------|----------------------------------|------------------------|
| | | Min. | Typ. | Max. | Min. | Typ. | Max. | |
| V_{io} | Input Offset Voltage $V_O = 1.4V$, $V_{ic} = 0V$ $T_{min} \leq T_{amb} \leq T_{max}$ | | 1.1 0.9 0.25 | 10 5 2 12 6.5 3 | | 1.1 0.9 0.25 | 10 5 2 12 6.5 3.5 | mV |
| DV_{io} | Input Offset Voltage Drift | | 2 | | | 2 | | $\mu V/^\circ C$ |
| I_{io} | Input Offset Current note 1 $V_{ic} = 5V$, $V_O = 5V$ $T_{min} \leq T_{amb} \leq T_{max}$ | | 1 | 100 | | 1 | 200 | pA |
| I_{ib} | Input Bias Current - see note 1 $V_{ic} = 5V$, $V_O = 5V$ $T_{min} \leq T_{amb} \leq T_{max}$ | | 1 | 150 | | 1 | 300 | pA |
| V_{OH} | High Level Output Voltage $V_{id} = 100mV$, $R_L = 100k\Omega$ $T_{min} \leq T_{amb} \leq T_{max}$ | 8.7 8.6 | 8.9 | | 8.7 8.5 | 8.9 | | V |
| V_{OL} | Low Level Output Voltage $V_{id} = -100mV$ | | | 50 | | | 50 | mV |
| A_{vd} | Large Signal Voltage Gain $V_{ic} = 5V$, $R_L = 100k\Omega$, $V_O = 1V$ to $6V$ $T_{min} \leq T_{amb} \leq T_{max}$ | 30 20 | 50 | | 30 10 | 50 | | V/mV |
| GBP | Gain Bandwidth Product $A_v = 40dB$, $R_L = 100k\Omega$, $C_L = 100pF$, $f_{in} = 100kHz$ | | 0.7 | | | 0.7 | | MHz |
| CMR | Common Mode Rejection Ratio $V_{ic} = 1V$ to $7.4V$, $V_O = 1.4V$ | 60 | 80 | | 60 | 80 | | dB |
| SVR | Supply Voltage Rejection Ratio $V_{CC}^+ = 5V$ to $10V$, $V_O = 1.4V$ | 60 | 80 | | 60 | 80 | | dB |
| I_{CC} | Supply Current (per amplifier) $A_v = 1$, no load, $V_O = 5V$ $T_{min} \leq T_{amb} \leq T_{max}$ | | 150 | 200 250 | | 150 | 200 300 | μA |
| I_o | Output Short Circuit Current $V_O = 0V$, $V_{id} = 100mV$ | | 60 | | | 60 | | mA |
| I_{sink} | Output Sink Current $V_O = V_{CC}$, $V_{id} = -100mV$ | | 45 | | | 45 | | mA |
| SR | Slew Rate at Unity Gain $R_L = 100k\Omega$, $C_L = 100pF$, $V_i = 3$ to $7V$ | | 0.6 | | | 0.6 | | V/ μs |
| ϕ_m | Phase Margin at Unity Gain $A_v = 40dB$, $R_L = 100k\Omega$ $C_L = 10pF$ $C_L = 100pF$ | | 50 30 | | | 50 30 | | Degrees |
| K_{OV} | Overshoot Factor $A_v = 40dB$, $R_L = 100k\Omega$ $C_L = 10pF$ $C_L = 100pF$ | | 30 50 | | | 30 50 | | % |
| e_n | Equivalent Input Noise Voltage $f = 1kHz$, $R_s = 100\Omega$ | | 38 | | | 38 | | $\frac{nV}{\sqrt{Hz}}$ |

1) Maximum values including unavoidable inaccuracies of the industrial test.

Typical characteristics for $I_{SET} = 25\mu A$

Figure 18. Supply current versus supply voltage

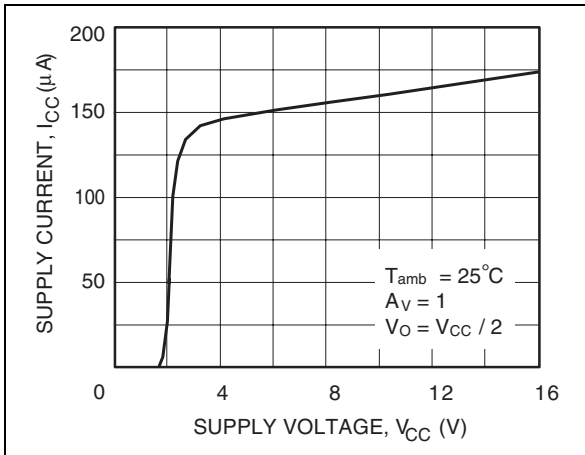

Figure 19. Input bias current versus free air temperature

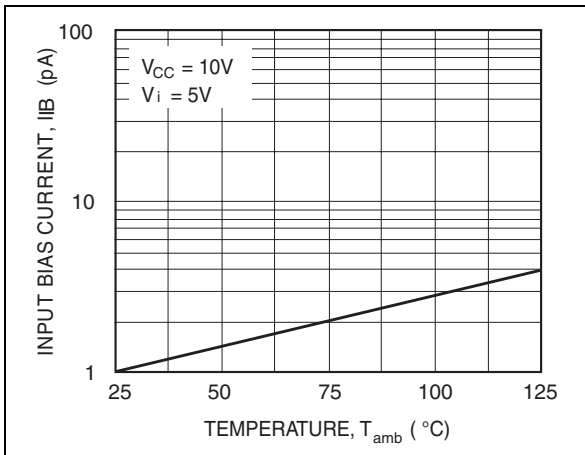

Figure 20. High level output voltage versus high level output current

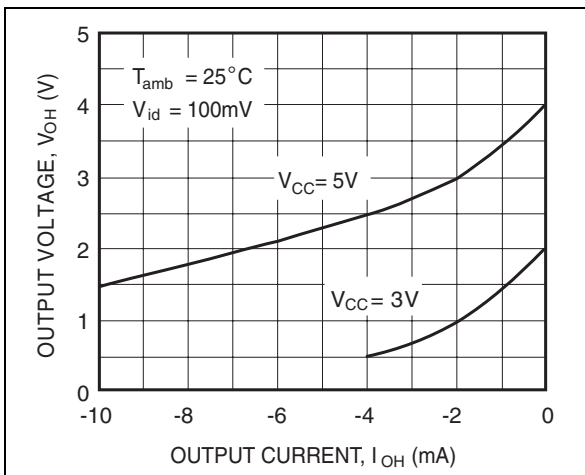

Figure 21. High level output voltage versus high level output current

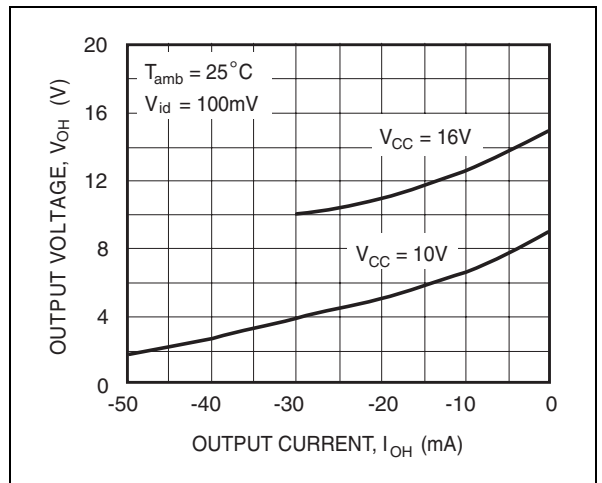

Figure 22. Low level output voltage versus low level output current

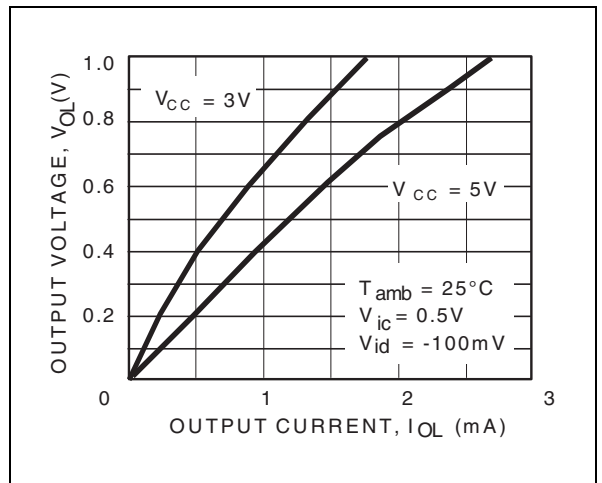

Figure 23. Low level output voltage versus low level output current

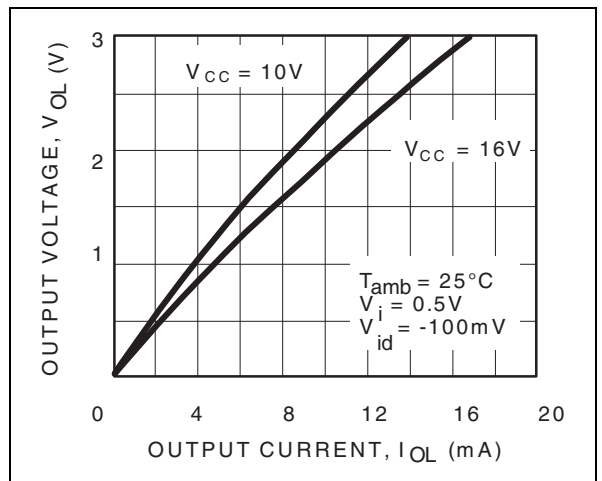

Figure 24. Open loop frequency response and phase shift

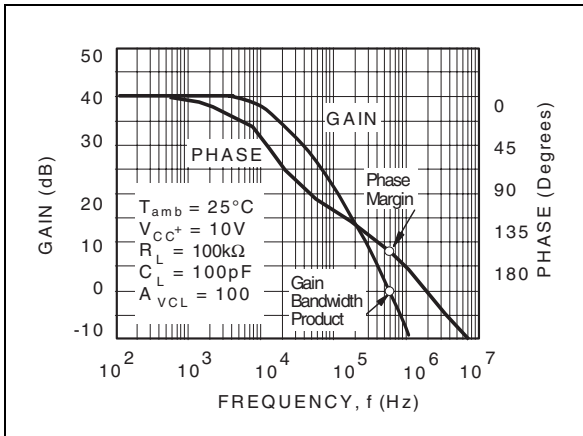

Figure 27. Phase margin versus capacitive load

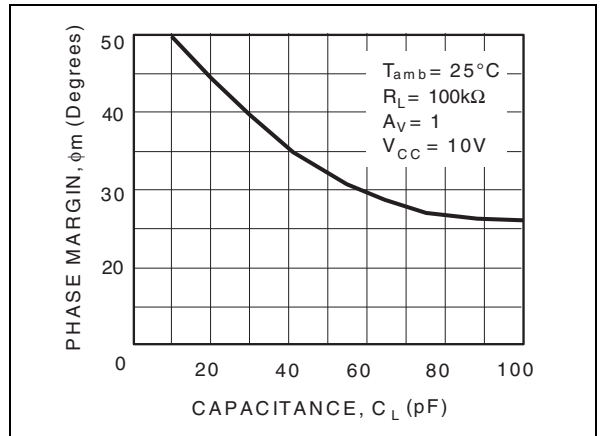

Figure 25. Gain bandwidth product versus supply voltage

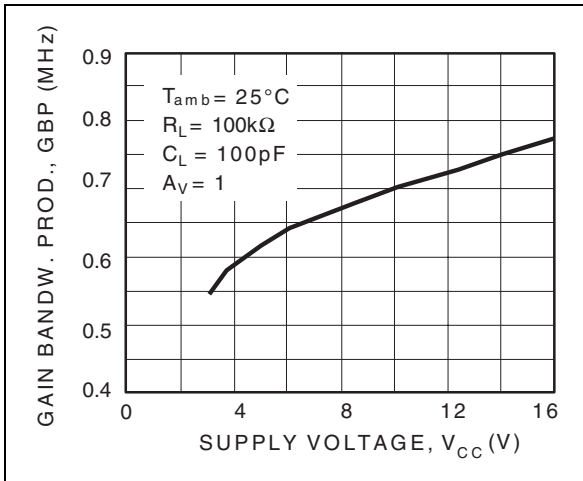

Figure 28. Slew rate versus supply voltage

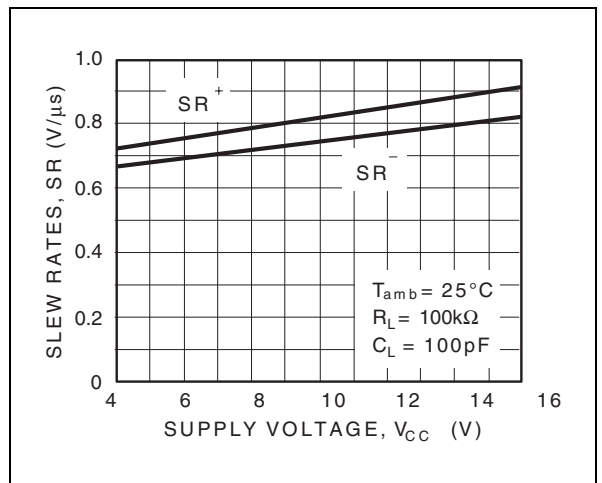
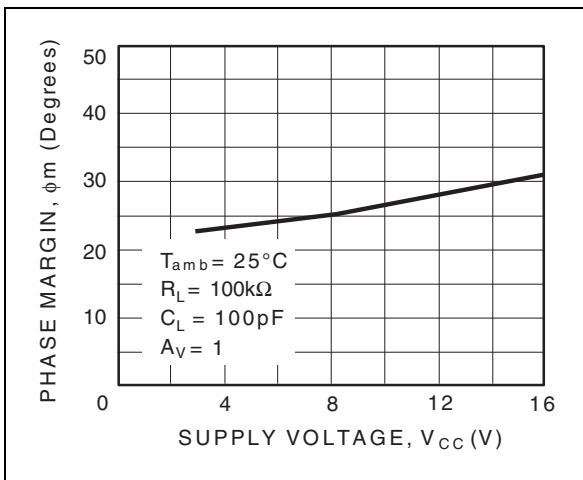

Figure 26. Phase margin versus supply voltage



5 Electrical Characteristics

Table 5. for $I_{SET} = 130\mu A$ - $V_{CC^+} = +10V$, $V_{CC^-} = 0V$, $T_{amb} = +25^{\circ}C$ (unless otherwise specified)

| Symbol | Parameter | TS271C/AC/BC | | | TS271I/AI/BI TS271M/AM/BM | | | Unit |
|------------|--|--------------|--------------------|--------------------------------|------------------------------|--------------------|----------------------------------|------------------------|
| | | Min. | Typ. | Max. | Min. | Typ. | Max. | |
| V_{io} | Input Offset Voltage $V_O = 1.4V$, $V_{ic} = 0V$ $T_{min} \leq T_{amb} \leq T_{max}$ | | 1.1 0.9 0.25 | 10 5 2 12 6.5 3 | | 1.1 0.9 0.25 | 10 5 2 12 6.5 3.5 | mV |
| DV_{io} | Input Offset Voltage Drift | | 2 | | | 2 | | $\mu V/^{\circ}C$ |
| I_{io} | Input Offset Current note 1 $V_{ic} = 5V$, $V_O = 5V$ $T_{min} \leq T_{amb} \leq T_{max}$ | | 1 | 100 | | 1 | 200 | pA |
| I_{ib} | Input Bias Current - see note 1 $V_{ic} = 5V$, $V_O = 5V$ $T_{min} \leq T_{amb} \leq T_{max}$ | | 1 | 150 | | 1 | 300 | pA |
| V_{OH} | High Level Output Voltage $V_{id} = 100mV$, $R_L = 10k\Omega$ $T_{min} \leq T_{amb} \leq T_{max}$ | 8.2 8.1 | 8.4 | | 8.2 8 | 8.4 | | V |
| V_{OL} | Low Level Output Voltage $V_{id} = -100mV$ | | | 50 | | | 50 | mV |
| A_{vd} | Large Signal Voltage Gain $V_{ic} = 5V$, $R_L = 10k\Omega$, $V_O = 1V$ to $6V$ $T_{min} \leq T_{amb} \leq T_{max}$ | 10 7 | 15 | | 10 6 | 15 | | V/mV |
| GBP | Gain Bandwidth Product $A_v = 40dB$, $R_L = 10k\Omega$, $C_L = 100pF$, $f_{in} = 100kHz$ | | 2.3 | | | 2.3 | | MHz |
| CMR | Common Mode Rejection Ratio $V_{ic} = 1V$ to $7.4V$, $V_O = 1.4V$ | 60 | 80 | | 60 | 80 | | dB |
| SVR | Supply Voltage Rejection Ratio $V_{CC^+} = 5V$ to $10V$, $V_O = 1.4V$ | 60 | 70 | | 60 | 70 | | dB |
| I_{CC} | Supply Current (per amplifier) $A_v = 1$, no load, $V_O = 5V$ $T_{min} \leq T_{amb} \leq T_{max}$ | | 800 | 1300 1400 | | 800 | 1300 1500 | μA |
| I_o | Output Short Circuit Current $V_O = 0V$, $V_{id} = 100mV$ | | 60 | | | 60 | | mA |
| I_{sink} | Output Sink Current $V_O = V_{CC^-}$, $V_{id} = -100mV$ | | 45 | | | 45 | | mA |
| SR | Slew Rate at Unity Gain $R_L = 10k\Omega$, $C_L = 100pF$, $V_i = 3$ to $7V$ | | 4.5 | | | 4.5 | | V/ μs |
| ϕ_m | Phase Margin at Unity Gain $A_v = 40dB$, $R_L = 10k\Omega$ $C_L = 10pF$ $C_L = 100pF$ | | 65 30 | | | 65 30 | | Degrees |
| K_{OV} | Overshoot Factor $A_v = 40dB$, $R_L = 10k\Omega$ $C_L = 10pF$ $C_L = 100pF$ | | 30 50 | | | 30 50 | | % |
| e_n | Equivalent Input Noise Voltage $f = 1kHz$, $R_s = 100\Omega$ | | 30 | | | 30 | | $\frac{nV}{\sqrt{Hz}}$ |

1) Maximum values including unavoidable inaccuracies of the industrial test.

Typical characteristics for $I_{SET} = 130\mu A$

Figure 29. Supply current (each amplifier) versus supply voltage

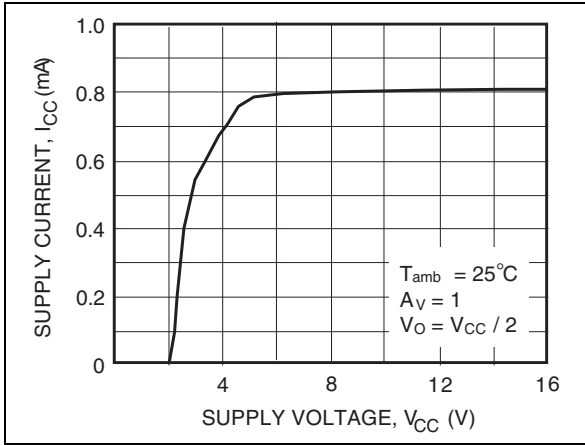

Figure 30. Input bias current versus free air temperature

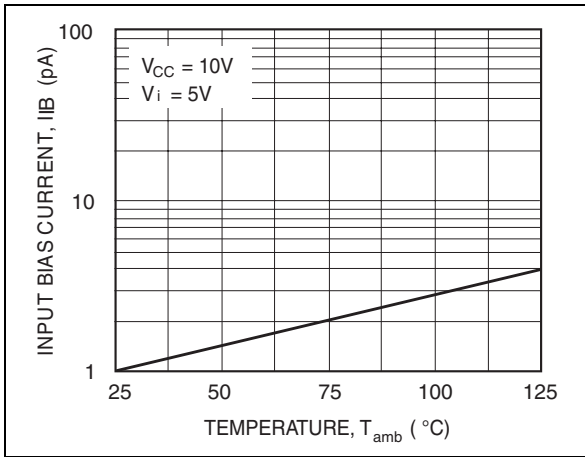

Figure 31. High level output voltage versus high level output current

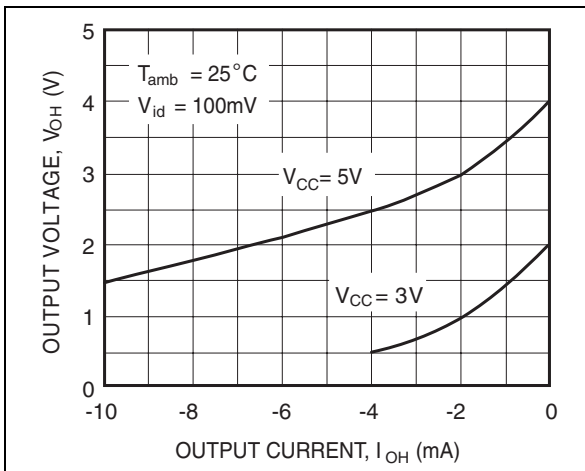

Figure 32. High level output voltage versus high level output current

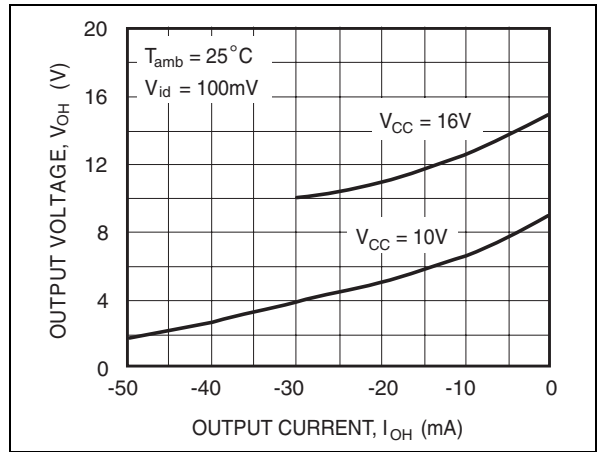

Figure 33. Low level output voltage versus low level output current

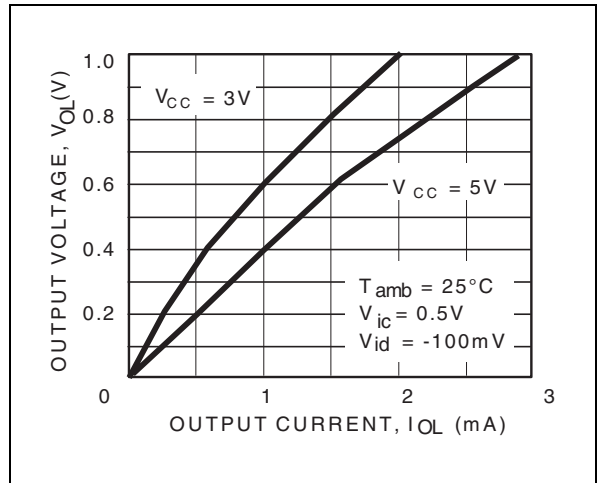

Figure 34. Low level output voltage versus low level output current

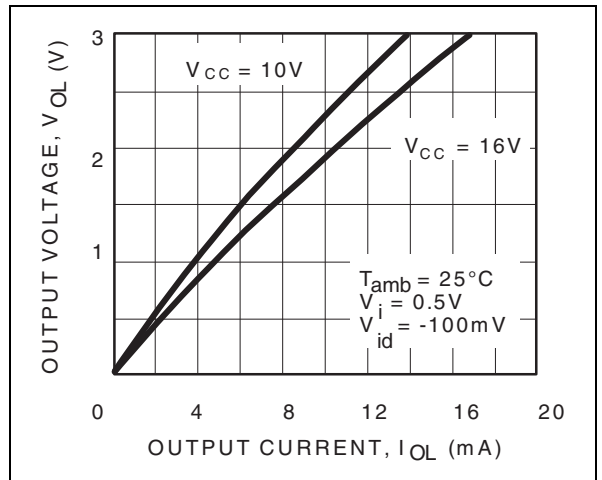

Figure 35. Open loop frequency response and phase shift

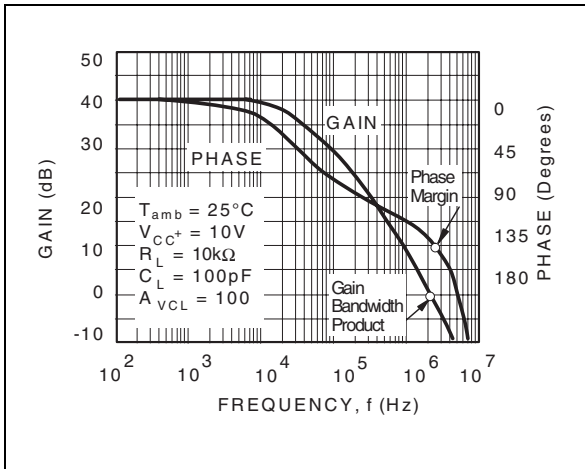

Figure 38. Phase margin versus capacitive load

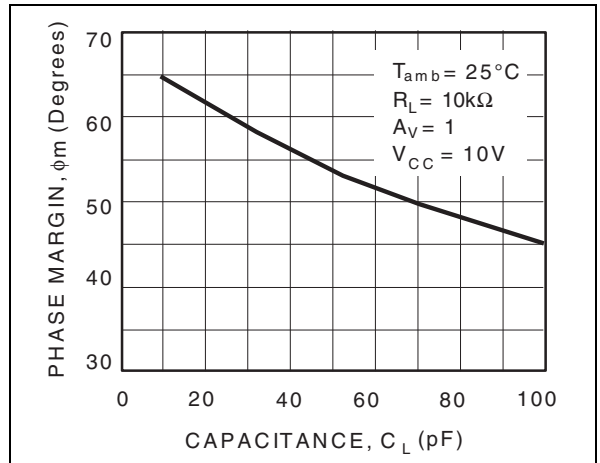

Figure 36. Gain bandwidth product versus supply voltage

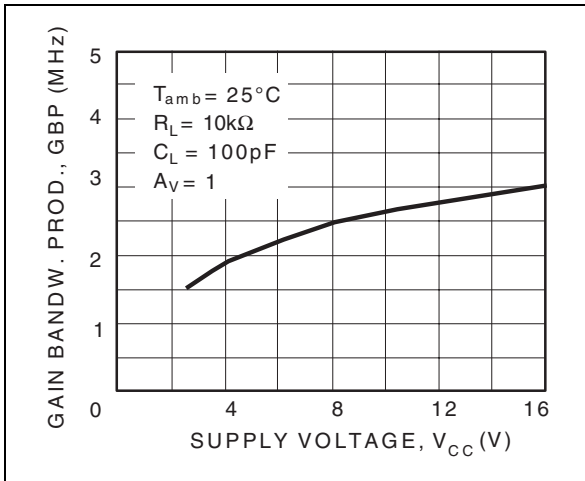

Figure 39. Slew rate versus supply voltage

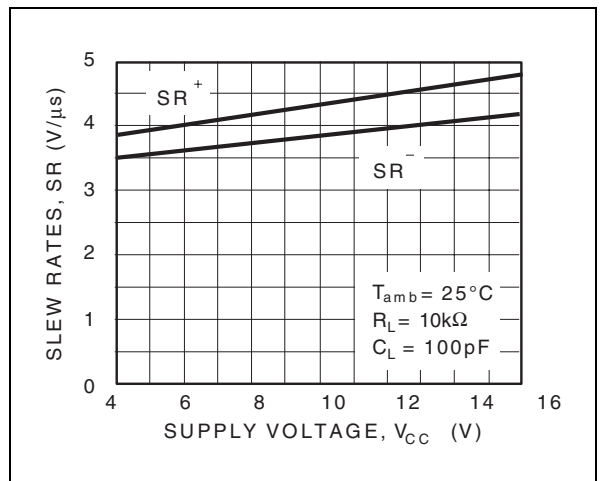
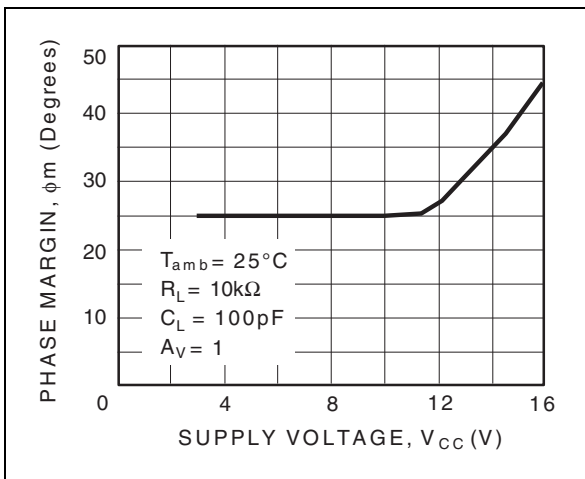

Figure 37. Phase margin versus supply voltage



6 Package Mechanical Data

Plastic DIP-8 MECHANICAL DATA

| DIM. | mm. | | | inch | | |
|------|------|------|------|-------|-------|-------|
| | MIN. | TYP | MAX. | MIN. | TYP. | MAX. |
| A | | 3.3 | | | 0.130 | |
| a1 | 0.7 | | | 0.028 | | |
| B | 1.39 | | 1.65 | 0.055 | | 0.065 |
| B1 | 0.91 | | 1.04 | 0.036 | | 0.041 |
| b | | 0.5 | | | 0.020 | |
| b1 | 0.38 | | 0.5 | 0.015 | | 0.020 |
| D | | | 9.8 | | | 0.386 |
| E | | 8.8 | | | 0.346 | |
| e | | 2.54 | | | 0.100 | |
| e3 | | 7.62 | | | 0.300 | |
| e4 | | 7.62 | | | 0.300 | |
| F | | | 7.1 | | | 0.280 |
| l | | | 4.8 | | | 0.189 |
| L | | 3.3 | | | 0.130 | |
| Z | 0.44 | | 1.6 | 0.017 | | 0.063 |

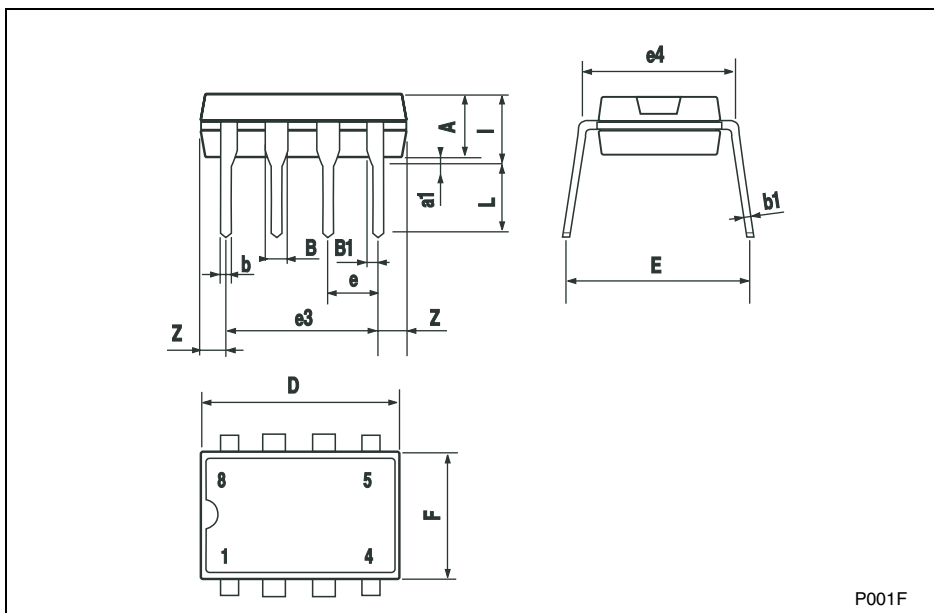

Package Mechanical Data

SO-8 MECHANICAL DATA

| DIM. | mm. | | | inch | | |
|------|-----------|------|------|-------|-------|-------|
| | MIN. | TYP. | MAX. | MIN. | TYP. | MAX. |
| A | 1.35 | | 1.75 | 0.053 | | 0.069 |
| A1 | 0.10 | | 0.25 | 0.04 | | 0.010 |
| A2 | 1.10 | | 1.65 | 0.043 | | 0.065 |
| B | 0.33 | | 0.51 | 0.013 | | 0.020 |
| C | 0.19 | | 0.25 | 0.007 | | 0.010 |
| D | 4.80 | | 5.00 | 0.189 | | 0.197 |
| E | 3.80 | | 4.00 | 0.150 | | 0.157 |
| e | | 1.27 | | | 0.050 | |
| H | 5.80 | | 6.20 | 0.228 | | 0.244 |
| h | 0.25 | | 0.50 | 0.010 | | 0.020 |
| L | 0.40 | | 1.27 | 0.016 | | 0.050 |
| k | 8° (max.) | | | | | |
| ddd | | | 0.1 | | | 0.04 |

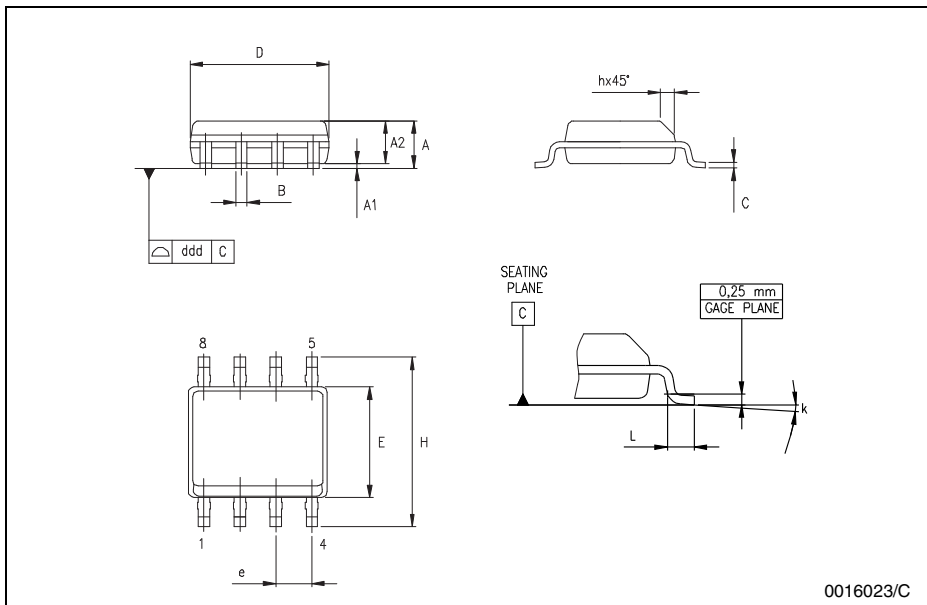

0016023/C