

POWER PRODUCTS
Features

- Fixed output option has automatic low power PFM mode for reduced quiescent current at light loads
- 2.25MHz +/- 10% fixed switching frequency
- Fixed output voltages: 0.8V, 0.9V, 1.2V, 1.5V, 1.8V, 2.5V, and 3.3V with +/- 2% output tolerance
- Input voltage range: 2.0V to 5.5V
- Voltage mode PWM control with input voltage feed-forward compensation
- Voltage supervisor for VOUT reported at the PG pin
- Input supply under voltage lockout
- Soft start for controlled startup with no overshoot
- Full protection for over-current, over-temperature, and VOUT overvoltage
- Less than 200nA in shutdown mode
- Multiple enable pins for flexible system sequencing
- Low external component count
- Junction operating temperature -40°C to 125°C
- Packaged in a 16 pin QFN (3x3)
- Product is lead-free, Halogen Free, RoHS / WEEE compliant

Applications

- Point of load
- Systems with deep submicron ASICs/FPGAs
- Set-top box
- Communications equipment
- Portable and handheld equipment

Description

The TS33010 is a DC/DC synchronous switching regulator with fully integrated power switches, internal compensation, and full fault protection. The switching frequency of 2.25MHz enables the use of extremely small filter components, resulting in smaller board space and reduced BOM costs.

When the input current is greater than approximately 50mA, the TS33010 utilizes PWM voltage mode feedback with input voltage feed-forward to provide a wide input voltage range without the need for external compensation.

When the input current is less than 50mA, the device uses a PFM mode to provide increased efficiency at light loads. The cross over between PFM and PWM modes is automatic and has hysteresis to prevent oscillation between the modes. Additionally, the nLP mode pin can be used to force the device into PWM mode to reduce the output ripple, if needed.

The TS33010 integrates a wide range of protection circuitry; including input supply under-voltage lockout, output under-voltage, output over-voltage, soft start, high side FET and low side FET current limits.

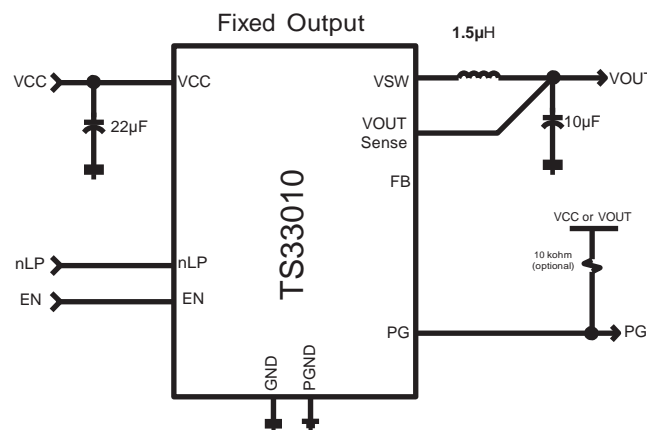
Typical Applications

Pinout

(Top View)

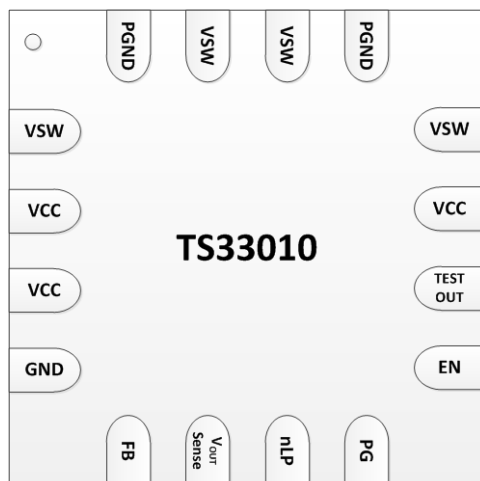

Pin Description

Pin #	Pin Name	Pin Function	Description
1	VSW	Switching Voltage Node	Connect to 1.5μH inductor. Short to Pins 12, 14, & 15
2	VCC	Input Voltage	Input voltage supply. Short to Pins 3 & 11
3	VCC	Input Voltage	Input voltage supply. Short to Pins 2 & 11
4	GND	GND	Ground for the internal circuitry of the device
5	FB	Feedback Input	Feedback voltage for the regulator when used in adjustable mode. Connect to the output voltage resistor divider for adjustable mode and No Connection for fixed output modes
6	V _{OUT} Sense	Output Voltage Sense	Output Voltage Sense. Requires kelvin connection to 10μF output capacitor
7	nLP	nLP Input	Forcing this pin high prevents the device from going into Low Power PFM mode operation
8	PG	PG Output	Power Good indicator Open-drain output.
9	EN	Enable Input	Input high voltage enables the device. Input low disables the device.
10	TEST OUT	Test Mode Output	Connect to GND. For internal testing use only.
11	VCC	Input Voltage	Input voltage supply. Short to Pins 2 & 3
12	VSW	Switching Voltage Node	Connect to 1.5μH inductor. Short to Pins 1, 14, & 15
13	PGND	Power GND	GND supply for internal low-side FET/integrated diode. Short to Pin 16
14	VSW	Switching Voltage Node	Connect to 1.5μH inductor. Short to Pins 1, 12, & 15
15	VSW	Switching Voltage Node	Connect to 1.5μH inductor. Short to Pins 1, 12, & 14
16	PGND	Power GND	GND supply for internal low-side FET/integrated diode. Short to Pin 13

Functional Block Diagram

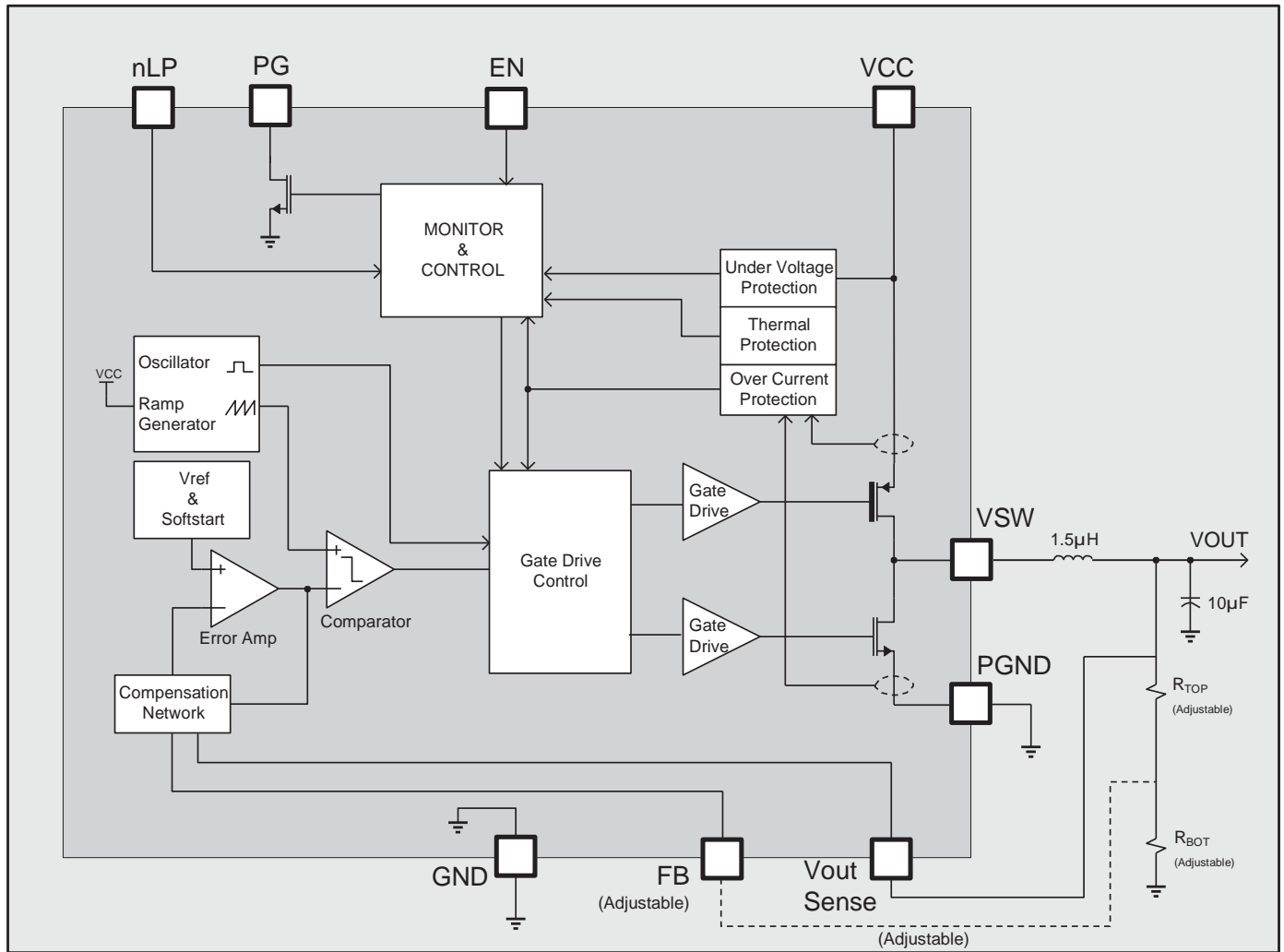

Figure 1: TS33010 Block Diagram for fixed and adjustable mode devices

Absolute Maximum Rating

Over operating free-air temperature range unless otherwise noted^(1, 2)

Parameter	Value	Unit
VCC	-0.3 to 6.0	V
VSW	-1 to 6.0	V
EN, PG,FB, nLP, TEST OUT, V _{OUT} Sense	-0.3 to 6.0	V
Electrostatic Discharge – Human Body Model	±2k	V
Electrostatic Discharge – Charge Device Model	±500	V
Lead Temperature (soldering, 10 seconds)	260	°C

Notes:

- (1) Stresses beyond those listed under “absolute maximum ratings” may cause permanent damage to the device. These are stress ratings only and functional operation of the device at these or any other conditions beyond those indicated under “recommended operating conditions” is not implied. Exposure to absolute-maximum-rated conditions for extended periods may affect device reliability.
- (2) All voltage values are with respect to network ground terminal.

Thermal Characteristics

Symbol	Parameter	Value	Unit
θ_{JA}	Thermal Resistance Junction to Air (Note 1)	50	°C/W
θ_{JC}	Thermal Resistance Junction to Case (Note 1)	3.9	°C/W

Note 1: Assumes QFN16 1 in² area of 2 oz copper and 25 °C ambient temperature.

Recommended Operating Conditions

Symbol	Parameter	Min	Typ	Max	Unit
VCC	Input Operating Voltage	2.0	3.6	5.5	V
T _{STG}	Storage Temperature Range	-65		150	°C
T _{JMAX}	Maximum Junction Temperature			150	°C
T _J	Operating Junction Temperature Range	-40		125	°C
L _{OUT}	Output Filter Inductor Typical Value (Note 1,3)		1.5		µH
C _{OUT}	Output Filter Capacitor Typical Value (Note 2,3)	3.3	10	13	µF
C _{OUT-ESR}	Output Filter Capacitor ESR	0	5	20	mΩ
C _{BYPASS}	Input Supply Bypass Capacitor Typical Value (Note 2)		22		µF

Note 1: For best performance, an inductor with a saturation current rating higher than the maximum V_{out} load requirement plus the inductor current ripple. See the inductor current ripple calculations in inductor calculations sections.

Note 2: For best performance, a low ESR ceramic capacitor– X7R or X5R types should be used. Y5V should be avoided.

Note 3: Min and max listed are to account for +/-20% variation of the typical value. Typical values of 10µF and 1.5µH are recommended.

Characteristics

Electrical characteristics, $T_J = -40^{\circ}\text{C}$ to 125°C , $V_{CC} = 3.6\text{V}$ (unless otherwise noted)

Symbol	Parameter	Condition	Min	Typ	Max	Unit
VCC Supply Voltage						
$I_{CC-NORM}$	Quiescent current Normal Mode	$I_{LOAD} = 0\text{A}$, $EN=V_{CC}$, $nLP=5\text{V}$, $V_{OUT}=1.8\text{V}$		7		mA
I_{CC-LPM}	Quiescent current Low Power PFM Mode	$I_{LOAD}=0\text{A}$, $EN=V_{CC}$, $nLP=0\text{V}$, $V_{OUT}=1.8\text{V}$		25	45	μA
$I_{CC-SHUTDOWN}$	Quiescent current Shutdown Mode	$EN=0\text{V}$		0.1	5	μA
VCC Under Voltage Lockout						
$V_{CC_{UV}}$	Input Supply Under Voltage Threshold	VCC Increasing		1.6	1.75	V
$V_{CC_{UV_HYST}}$	Input Supply Under Voltage Threshold Hysteresis			50		mV
OSC						
F_{OSC}	Oscillator Frequency		2	2.25	2.5	MHz
PG Open Drain Output						
T_{PG}	PG Release Timer			14		ms
I_{OH-PG}	High-Level Output Leakage	$V_{PG}=5\text{V}$ $V_{CC}=5\text{V}$		0.1		μA
V_{OL-PG}	Low-Level Output Voltage	$I_{PG} = -0.3\text{mA}$			0.1	V
EN / nLP Input Voltage Thresholds						
$V_{IH-EN/nLP}$	High Level Input Voltage	$V_{CC}=2\text{V}$ to 5V	1.5			V
$V_{IL-EN/nLP}$	Low Level Input Voltage	$V_{CC}=2\text{V}$ to 5V			0.4	V
$V_{HYST-EN/nLP}$	Input Hysteresis	$V_{CC}=2\text{V}$ to 5V		200		mV
I_{IN-EN}	EN Input Leakage	$V_{EN}=5\text{V}$, $V_{CC}=5\text{V}$		0.1		μA
		$V_{EN}=0\text{V}$, $V_{CC}=5\text{V}$		0.1		μA
nLP_{PD}	nLP Pulldown Resistor	Pulldown to GND		65		$\text{K}\Omega$
Thermal Shutdown						
TSD	Thermal Shutdown Junction Temperature Voltage			190		$^{\circ}\text{C}$
TSD_{HYST}	TSD Hysteresis			15		$^{\circ}\text{C}$

Regulator Characteristics

Electrical characteristics, $T_j = -40^{\circ}\text{C}$ to 125°C , $V_{CC} = 3.6\text{V}$ (unless otherwise noted)

Symbol	Parameter	Condition	Min	Typ	Max	Unit
Switch Mode Regulator: L=1.5μH and C=10μF						
$V_{\text{OUT-PWM}}$	Output Voltage Tolerance in PWM Mode		$V_{\text{OUT}} - 2\%$	V_{OUT}	$V_{\text{OUT}} + 2\%$	V
$R_{\text{DS(on)}}$	High Side Switch On Resistance	$I_{\text{VSW}} = -500\text{mA}$ (Note 1)		150		m Ω
	Low Side Switch On Resistance	$I_{\text{VSW}} = 500\text{mA}$ (Note 1)		95		m Ω
I_{OUT}	Output Current	$V_{CC} \geq 2.5\text{V}$			500	mA
I_{OUT}	Output Current	$V_{CC} < 2.5\text{V}$			300	mA
I_{OCDHS}	Over Current Detect HS		0.7	0.9		A
I_{OCDLS}	Over Current Detect LS		0.7	0.9		A
$V_{\text{OUT-LINE}}$	Output Line Regulation	$V_{CC} = 2.5\text{V}$ to 5V , $V_{\text{OUT}} = 1.8\text{V}$, $I_{\text{LOAD}} = 300\text{mA}$	-15	(Note 2)	15	mV
$V_{\text{OUT-LOAD}}$	Output Load Regulation	$I_{\text{LOAD}} = 10\text{mA}$ to 300mA , $V_{CC} = 5\text{V}$, $V_{\text{OUT}} = 1.8\text{V}$	1.791	1.8	1.809	V
FB_{TH}	Feedback Reference	FB Switch Point (Note 3)		0.6		V
$\text{FB}_{\text{TH-TOL}}$	Feedback Reference Tolerance		-1.5		1.5	%
I_{FB}	Feedback Input Current			100		nA
T_{SS}	Softstart Ramp Time			1.2		ms
$V_{\text{OUT-PG}}$	V_{OUT} Power Good Threshold			$85\% V_{\text{OUT}}$		
$V_{\text{OUT-PG-HYST}}$	V_{OUT} Power Good Hysteresis			$2\% V_{\text{OUT}}$		
$V_{\text{OUT-OV}}$	V_{OUT} Over Voltage Threshold			$106\% V_{\text{OUT}}$		
$V_{\text{OUT-OV-HYST}}$	V_{OUT} Over Voltage Hysteresis			$2\% V_{\text{OUT}}$		

Note 1: $R_{\text{DS(on)}}$ is characterized at 500mA and tested at lower current in production.

Note 2: Specified Output Line Reg is relative to nominal VCC.

Note 3: FB is for adjustable part only.

Typical efficiency vs. output current

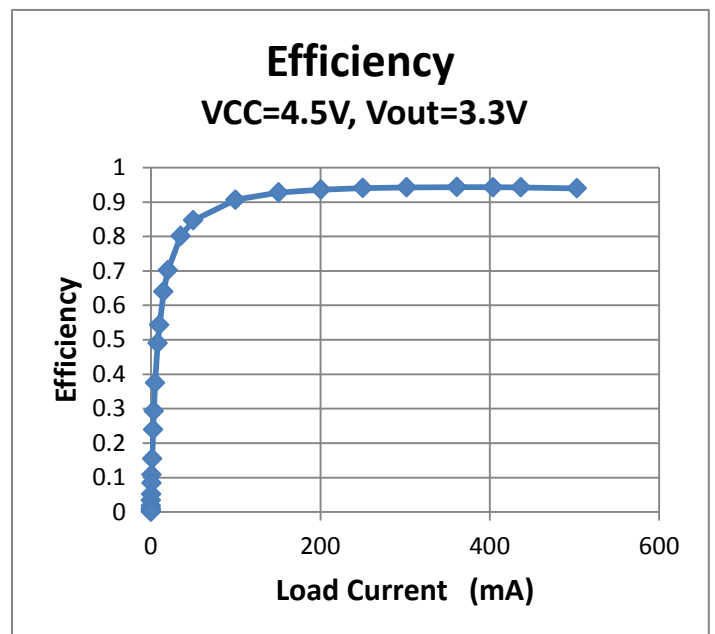
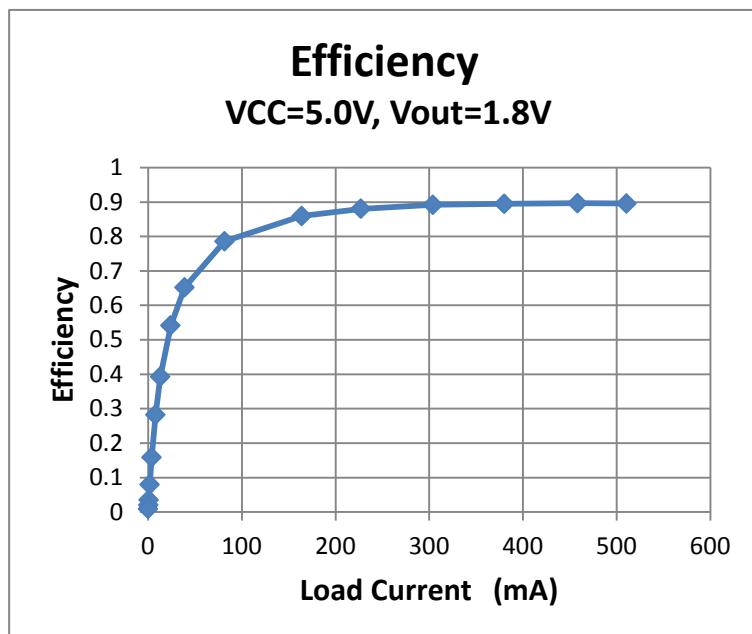
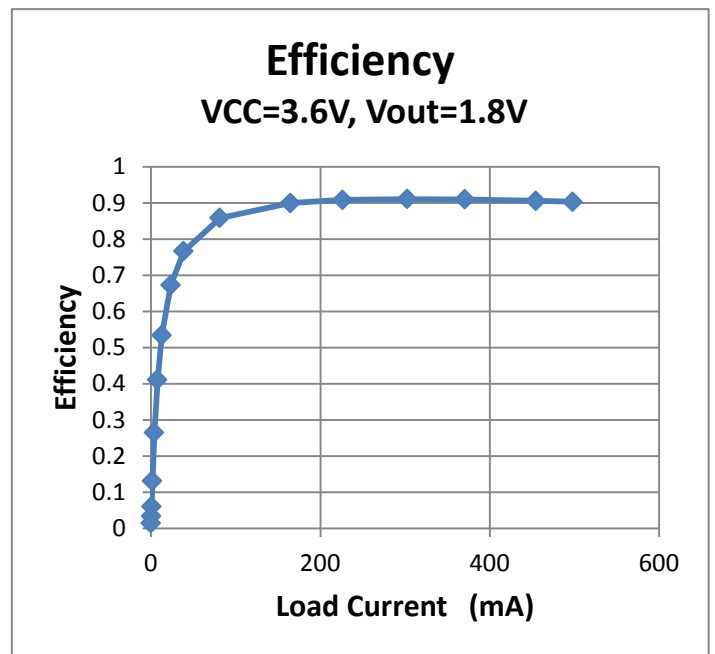
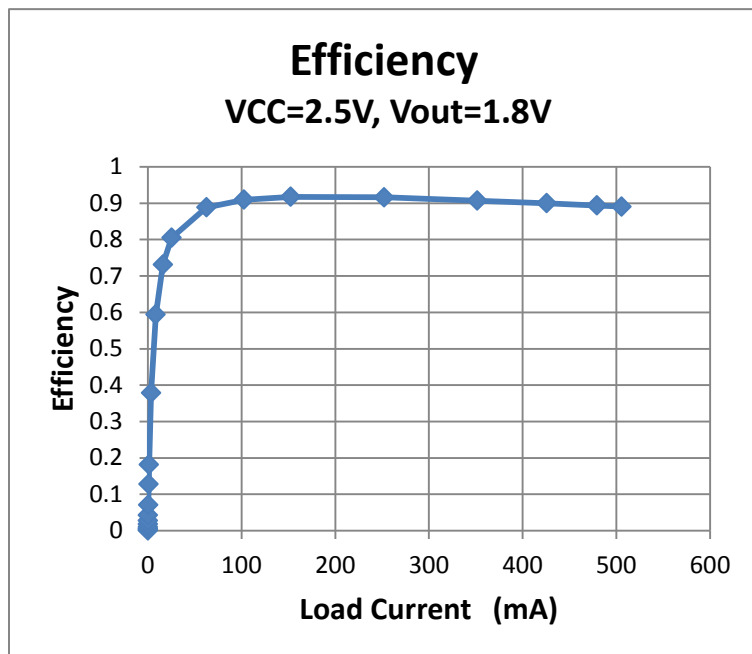

Functional Description

This voltage-mode Point of Load (POL) synchronous step-down power supply product can be used in the consumer, and industrial market segments. It includes flexibility to be used for a wide range of output voltages and is optimized for high efficiency power conversion with low RDSON integrated synchronous switches. A 2.25MHz internal switching frequency facilitates low cost LC filter combinations and improved transient response. Additionally, the fixed output version, with integrated Power on Reset and Fault circuitry enables a minimal external component count to provide a complete power supply solution for a variety of applications.

Detailed Pin Description

Unregulated input, VCC

This terminal is the unregulated input voltage source for the IC. It is recommended that a 22 μ F bypass capacitor be placed close as possible to the VCC pins for best performance. Since this is the main supply for the IC, good layout practices need to be followed for this connection.

Feedback, FB

This is the voltage feedback input terminal for the adjustable version. For the fixed mode versions, this pin should be left floating and not connected.

The connection on the PCB should be kept as short as

possible from the feedback resistors, kept away from the VSW threshold, connections or other switching/high frequency nodes, and should not be shared with any other connection. This should minimize stray coupling, reduce noise injection, and minimize voltage shift cause by output load.

To choose the resistors for the adjustable version, use the following equation:

$$V_{OUT} = 0.6 (1 + R_{TOP}/R_{BOT})$$

For stability, R_{TOP} should be 270K Ohms to 330K Ohms.

Output Voltage Sense, V_{OUT} Sense

This is the input terminal for the voltage output feedback and is needed for both adjustable and fixed voltage versions. This should be connected to the main output capacitor, and the same good layout practices should be followed as for the FB connection. Keep this line as short as possible, keep it away from the VSW and other switching or high frequency traces, and do not share this connection with any other connection on the PCB.

Switching output, VSW

This is the switching node of the regulator. It should be connected directly to the 1.5 μ H inductor with a wide, short trace. It is switching between VCC and PGND at the switching frequency.

Ground, GND

This ground is used for the majority of the device including the analog reference, control loop, and other circuits.

Power Ground, PGND

This is a separate ground connection used for the low side synchronous FET to isolate switching noise from the rest of the device.

Enable, EN

This is an input terminal to activate the entire device. This will enable the internal reference, oscillator, etc, and allow the fault detection circuitry to work correctly. Notice that the EN needs to be low for the part to exhibit less than 200nA quiescent current. The input threshold is TTL/CMOS compatible.

Power Good Output, PG

This is an open drain, active high output. The switched mode output voltage is monitored and the PG line will remain

low until the output voltage reaches the V_{OUT-UV} approximately 85% of the final regulation output. Once the internal comparator detects the output voltage is above the desired threshold, an internal 14ms delay timer is activated and the PG line is de-asserted to high when this delay timer expires. In the event the output voltage decreases below V_{OUT-UV} the PG line will be asserted low immediately and remain low until the output rises above V_{OUT-UV} and the delay timer times out again. If EN is pulled low and the VCC input undervoltage trips, the PG pin will immediately be pulled low.

nLow Power Mode Output, nLP

This is an input to force the PWM mode when light load is on the output. The PFM low power mode has higher output voltage ripple, which is some applications may be unacceptable. If low ripple is needed on the output this pin can be tied to VCC input, or switched above 1.5V during operation to force the device into normal PWM mode.

Internal Protection Details

Internal Current Limit

Current limit is always active when the regulator is enabled. High side current limit will shorten the high side on time and tri-state the high side. Additionally, low side current limit will protect the low side FET and turn off the switch if current limit is sensed on the low side switch. Since the output is fully synchronous, the current limit is protected on the low side in both the positive and negative direction.

Soft Start

Soft start ensures current limit does not prevent regulator startup and minimize overshoot at startup. The typical startup time is 1.2ms. These values do not change with output voltage, current limit settings, or adjustable/fixed mode. The soft start is re-triggered with the any rising edge that enables the regulator, including the EN input pins, thermal shutdown, VCC Undervoltage, or a VCC Power cycle.

Output Overvoltage

If the output of the regulator exceeds 106% of the regulation voltage, the VSW outputs will tri-state to protect the device from damage. This check occurs at the start of each switching cycle. If it occurs during the middle of a cycle, the switching for that cycle will complete, and the VSW outputs will tri-state at the beginning of the next cycle.

VCC Under-Voltage Lockout

The device is held in the off state until VCC reaches 1.60V. There is a 50mV hysteresis on this input, which requires the input to fall below 1.55V before the device will disable.

External Component Selection

The internal compensation is optimized for a 10 μ F output capacitor and a 1.5 μ H inductor. To keep the output ripple low, a low ESR (less than 20mOhm) ceramic is recommended. For optimal over-current protection, the inductor should be able to handle 1A without saturation.

Application Using A Multi-Layer PCB

To maximize the efficiency of this package for application on a single layer or multi-layer PCB, certain guidelines must be followed when laying out this part on the PCB.

The following are guidelines for mounting the exposed pad IC on a Multi-Layer PCB with ground a plane.

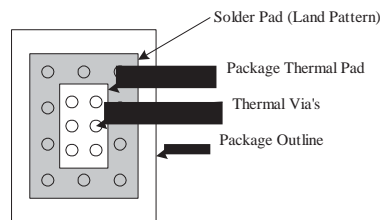

Package and PCB Land Configuration
For a Multi-Layer PCB

JEDEC standard FR4 PCB Cross-section:

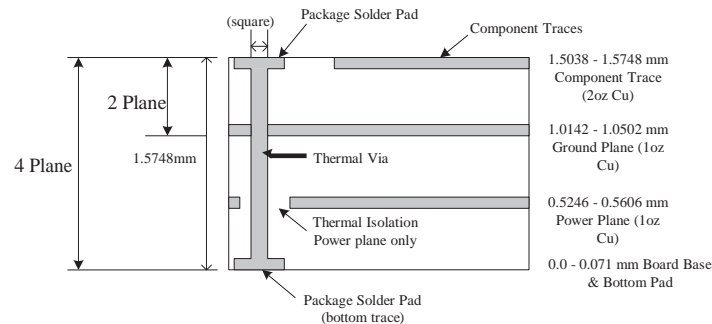

Multi-Layer Board (Cross-sectional View)

In a multi-layer board application, the thermal vias are the primary method of heat transfer from the package thermal pad to the internal ground plane. The efficiency of this method depends on several factors, including die area, number of thermal vias, thickness of copper, etc.

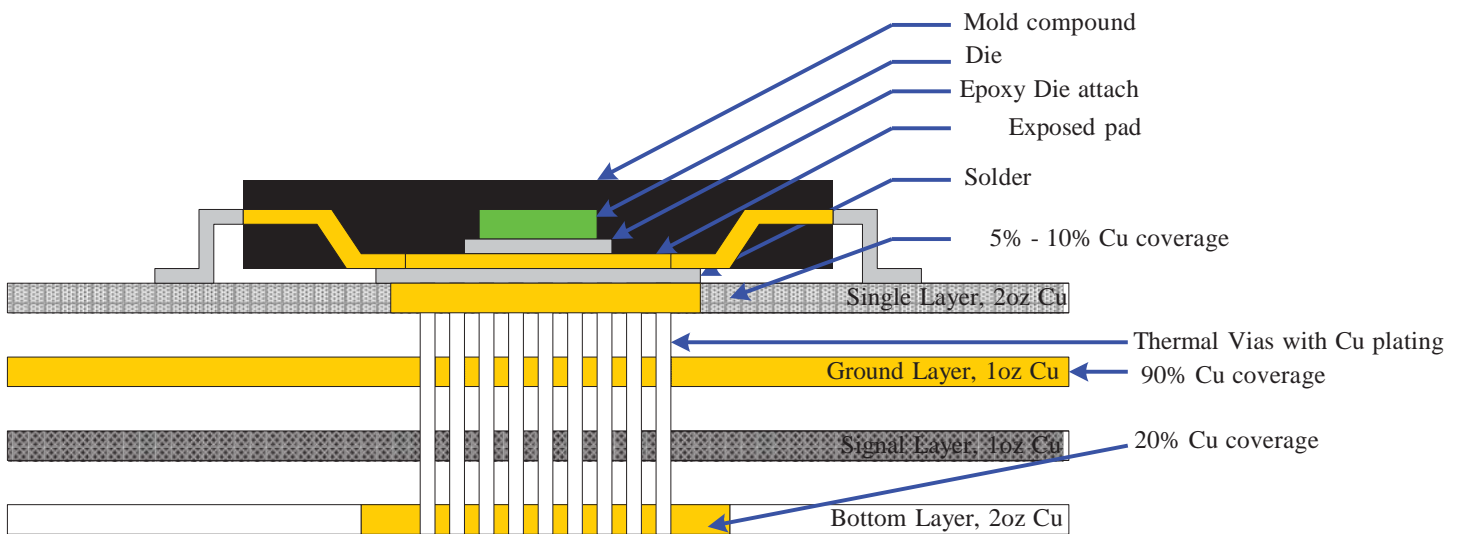

Note: NOT to Scale

The above drawing is a representation of how the heat can be conducted away from the die using an exposed pad package. Each application will have different requirements and limitations and therefore the user should use sufficient copper to dissipate the power in the system. The output current rating for the linear regulators may have to be de-rated for ambient temperatures above 85°C. The de-rate value will depend on calculated worst case power dissipation and the thermal management implementation in the application.

Application Using A Single Layer PCB

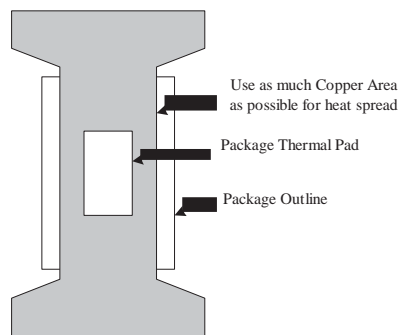

Layout recommendations for a Single Layer PCB: utilize as much Copper Area for Power Management. In a single layer board application the thermal pad is attached to a heat spreader (copper areas) by using low thermal impedance attachment method (solder paste or thermal conductive epoxy).

In both of the methods mentioned above it is advisable to use as much copper traces as possible to dissipate the heat.

IMPORTANT:

If the attachment method is NOT implemented correctly, the functionality of the product is not guaranteed. Power dissipation capability will be adversely affected if the device is incorrectly mounted onto the circuit board.

Package Mechanical Drawings (all dimensions in mm)

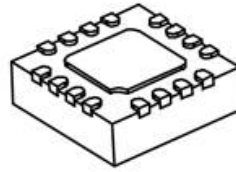

Part Number	Voltage Assign	Marking Code
TS33010-M000QFNR	ADJ V	33M00
TS33010-M008QFNR	0.8 V	33M08
TS33010-M009QFNR	0.9 V	33M09
TS33010-M012QFNR	1.2 V	33M12
TS33010-M015QFNR	1.5 V	33M15
TS33010-M018QFNR	1.8 V	33M18
TS33010-M025QFNR	2.5 V	33M25
TS33010-M033QFNR	3.3 V	33M33

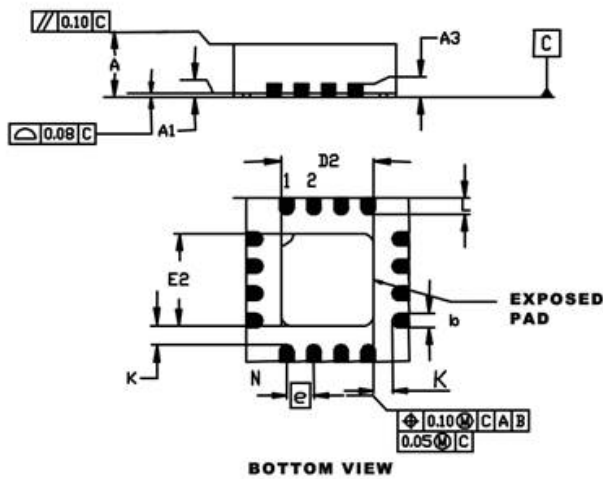

	Units	MILLIMETERS		
		MIN	NOM	MAX
Number of Pins	N	16		
Pitch	e	0.50 BSC		
Overall Height	A	0.80	0.90	1.00
Standoff	A1	0.00	0.02	0.05
Contact Thickness	A3	0.20 REF		
Overall Length	D	3.00 BSC		
Exposed Pad Width	E2	1.55	1.70	1.80
Overall Width	E	3.00 BSC		
Exposed Pad Length	D2	1.55	1.70	1.80
Contact Width	b	0.20	0.25	0.30
Contact Length	L	0.20	0.30	0.40
Contact-to-Exposed Pad	K	0.20	-	-

PCB Board Land Pattern

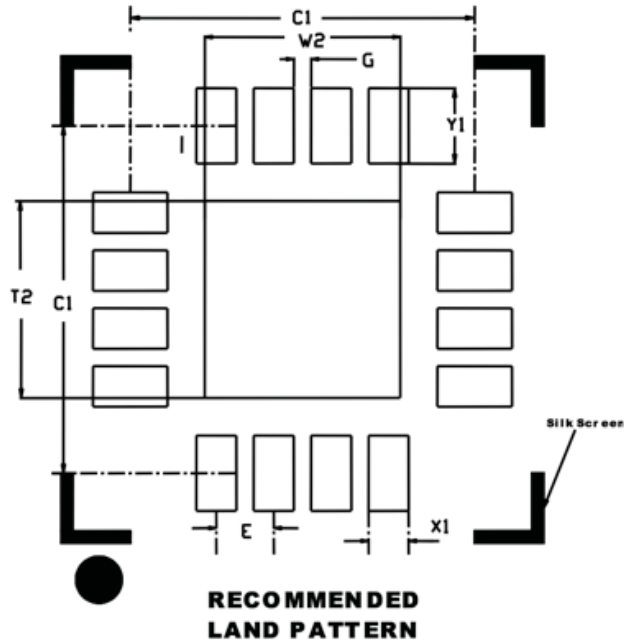

DIMENSIONS IN MILLIMETERS

	Units	MILLIMETERS		
		MIN	NOM	MAX
	Dimension Limits			
Contact Pitch	E	0.50 BSC		
Optional Center Pad Width	W2	-	-	1.70
Optional Center Pad Length	T2	-	-	1.70
Contact Pad Spacing	C1	-	3.00	-
Contact Pad Spacing	C2	-	3.00	-
Contact Pad Width (X8)	X1	-	-	0.35
Contact Pad Length (X8)	Y1	-	-	0.65
Distance Between Pads	G	0.15	-	-

Notes:

Dimensions and tolerances per ASME Y14.5M.

BSC: Basic Dimension. Theoretically exact values shown without tolerances.

REF: Reference Dimension, usually without tolerance, for information only.

Product Ordering Information

Part Number	Description
TS33010-M008QFNR	2.25MHz Sync Buck, 500mA - 0.8V
TS33010-M009QFNR	2.25MHz Sync Buck, 500mA - 0.9V
TS33010-M012QFNR	2.25MHz Sync Buck, 500mA - 1.2V
TS33010-M015QFNR	2.25MHz Sync Buck, 500mA - 1.5V
TS33010-M018QFNR	2.25MHz Sync Buck, 500mA - 1.8V
TS33010-M025QFNR	2.25MHz Sync Buck, 500mA - 2.5V
TS33010-M033QFNR	2.25MHz Sync Buck, 500mA - 3.3V
TS33010-M000QFNR	2.25MHz Sync Buck, 500mA - ADJ