

6A, 600V - 1000V Standard Bridge Rectifier

FEATURES

- AEC-Q101 qualified available
- Thin Single-in-line low profile package ideal for compact required circuit
- Glass passivated chip junction
- High surge current capability
- UL Recognized File # E-326243
- RoHS Compliant
- Halogen-free according to IEC 61249-2-21

APPLICATIONS

- Switching mode power supply
- Adapters
- Lighting application

MECHANICAL DATA

- Case: KBJL
- Molding compound meets UL 94V-0 flammability rating
- Terminal: Matte tin plated leads, solderable per J-STD-002
- Meet JESD 201 class 2 whisker test
- Mounting torque: 0.56 N·m maximum
- Polarity: As marked
- Weight: 2.60g (approximately)

KEY PARAMETERS		
PARAMETER	VALUE	UNIT
I_F	6	A
V_{RRM}	600 - 1000	V
I_{FSM}	150	A
$T_{J\ MAX}$	150	°C
Package	KBJL	
Configuration	Quad	

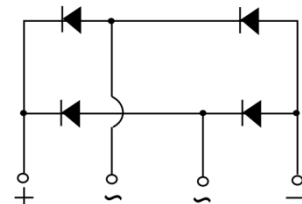
KBJL

ABSOLUTE MAXIMUM RATINGS ($T_A = 25^\circ\text{C}$ unless otherwise noted)

PARAMETER	SYMBOL	TS6KL60	TS6KL80	TS6KL100	UNIT
Marking code on the device		TS6KL60	TS6KL80	TS6KL100	
Repetitive peak reverse voltage	V_{RRM}	600	800	1000	V
Reverse voltage, total rms value	$V_{R(RMS)}$	420	560	700	V
Forward current	I_F	6			A
Surge peak forward current, single half sine-wave superimposed on rated load	I_{FSM}	$t = 8.3\text{ms}$	150		A
		$t = 1.0\text{ms}$	280		A
Rating for fusing ($t < 8.3\text{ms}$)	I^2t	93.37			A^2s
Junction temperature	T_J	- 55 to +150			°C
Storage temperature	T_{STG}	- 55 to +150			°C

THERMAL PERFORMANCE

PARAMETER	SYMBOL	TYP	UNIT
Junction-to-ambient thermal resistance	$R_{\theta JA}$	7	°C/W
Junction-to-case thermal resistance	$R_{\theta JC}$	2	°C/W

Thermal Performance Note: Units mounted on 4" x 6" x 0.25" Al-plate

ELECTRICAL SPECIFICATIONS ($T_A = 25^\circ\text{C}$ unless otherwise noted)

PARAMETER	CONDITIONS	SYMBOL	TYP	MAX	UNIT
Forward voltage per diode ⁽¹⁾	$I_F = 3A, T_J = 25^\circ\text{C}$	V_F	-	1.05	V
Reverse current @ rated V_R per diode ⁽²⁾	$T_J = 25^\circ\text{C}$	I_R	-	5	μA
	$T_J = 125^\circ\text{C}$		-	150	μA

Notes:

1. Pulse test with $PW = 0.3\text{ms}$
2. Pulse test with $PW = 30\text{ms}$

ORDERING INFORMATION

ORDERING CODE ⁽¹⁾⁽²⁾	PACKAGE	PACKING
TS6KLx	KBJL	20 / Tube
TS6KLxH	KBJL	20 / Tube

Notes:

1. "x" defines voltage from 600V(TS6KL60) to 1000V(TS6KL100)
2. "H" means AEC-Q101 qualified

CHARACTERISTICS CURVES

($T_A = 25^\circ\text{C}$ unless otherwise noted)

Fig.1 Forward Current Derating Curve

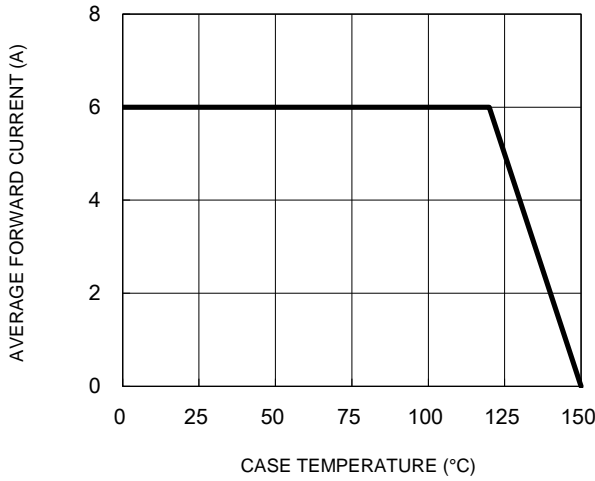

Fig.2 Typical Junction Capacitance

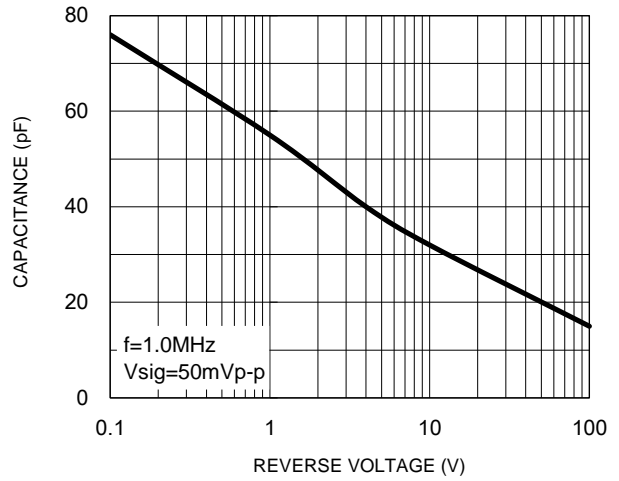

Fig.3 Typical Reverse Characteristics

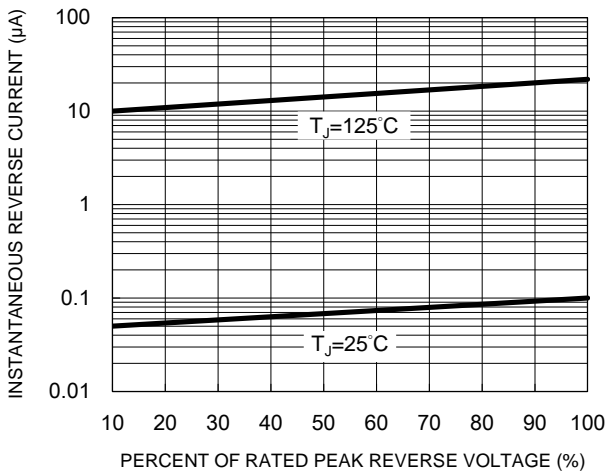

Fig.4 Typical Forward Characteristics

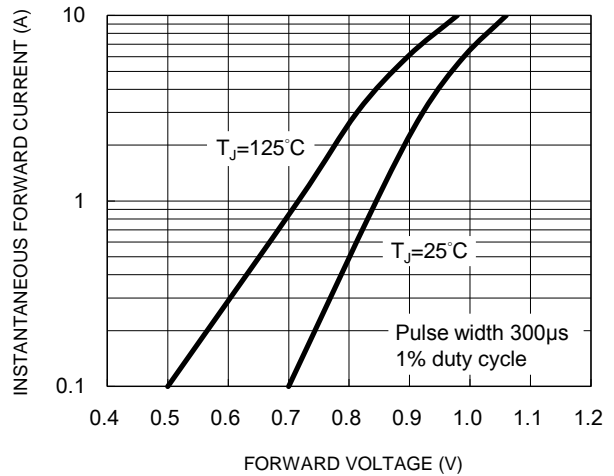
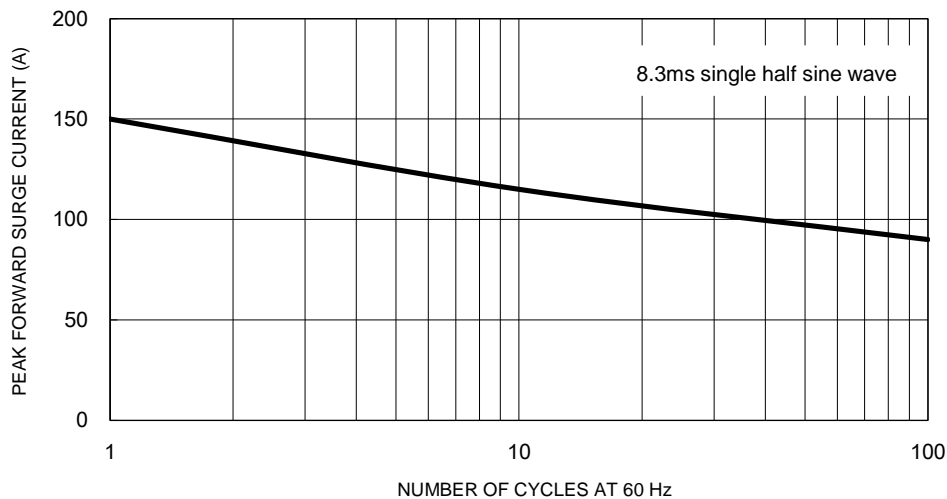
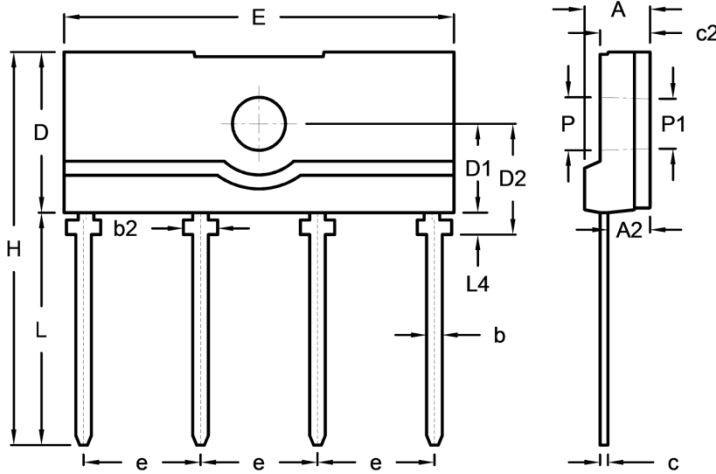

Fig.5 Maximum Non-Repetitive Forward Surge Current



PACKAGE OUTLINE DIMENSIONS

KBJL



DIM.	Unit (mm)		Unit (inch)	
	Min.	Max.	Min.	Max.
A	4.00	4.40	0.157	0.173
A2	2.50	2.90	0.098	0.114
b	0.90	1.10	0.035	0.043
b2	2.10	2.30	0.083	0.091
c	0.30	0.70	0.012	0.028
c2	3.00	3.40	0.118	0.134
D	10.00	10.60	0.394	0.417
D1	5.50	5.90	0.217	0.232
D2	6.90	7.30	0.272	0.287
E	24.70	25.30	0.972	0.996
e	7.30	7.70	0.287	0.303
H	24.90	25.50	0.980	1.004
L	14.40	15.40	0.567	0.606
L4	1.20	1.60	0.047	0.063
P	3.30	3.50	0.130	0.138
P1	3.10	3.30	0.122	0.130

MARKING DIAGRAM



- P/N = Marking Code
- G = Green Compound
- YWW = Date Code
- F = Factory Code