



### Features

- ◆ Universal battery controller module for uninterruptable 24 VDC and 48 VDC bus voltage
- ◆ Redundant inputs for two independent sources
- ◆ Battery protection for over voltage, deep discharge, short circuit and reverse connection
- ◆ Alarm outputs for input, output and battery condition
- ◆ Remote On/Off for battery
- ◆ Controlled end of charge voltage by temperature sensor
- ◆ International safety approval package
- ◆ 3-year product warranty



This module provides a professional battery management system to charge and monitor an external 12V lead-acid battery. Together with a power supply of the TSP series or any other stabilized 24 VDC or 48 VDC power supply a perfect DC-UPS system can be configured. The connected battery will be charged and held in charged mode by the power supply. In the event of a mains power failure the battery will supply the output power until the battery is discharged. A step up converter is used to maintain the selected output voltage level,  $V_{nom} - 6\%$  (typical). To avoid overcharging the battery, an external temperature sensor adjusts the battery voltage automatically to the required end of charge voltage. This can extend the battery life. The battery is protected against deep discharge. Mains power and battery status are monitored regularly and failures indicated by corresponding LED's and alarm outputs. The module also provides an external On/Off input to switch-off both, power supply and battery.



TSP-TS battery temperature sensor (10 kOhm NTC with 2m cable) optional

### Models

Order code	Inputs	Input voltage range	Output Current max.*	Output Power max.	Back up battery
TSP-BCMU360	2 x 360 W, for any single or two identical 24 VDC or 48 VDC sources	24-28 or 48-56 VDC (range selection with jumper)	24 VDC / 15 A 48 VDC / 7.5A	360 W	12V lead acid battery (to purchase on local market)

\* Maximum current at nominal  $V_{out}$

### External Batteries:

For external batteries we recommend:

Datasheet: [www.tracopower.com/products/tsp-panas\\_072.pdf](http://www.tracopower.com/products/tsp-panas_072.pdf)

### Output Specifications

Output voltage / current	- Normal Mode	24 VDC mode: $V_{in} - (0.4 - 0.8V)$ ; 15 A max. 48 VDC mode: $V_{in} - (0.4 - 0.7V)$ ; 7.5 A max.
	- Buffer Mode	24 VDC mode: 22.2 – 22.9 VDC; 10 A (15 A in boost mode for 10min) 48 VDC mode: 44.6 – 45.3 VDC; 5 A (7.5 A in boost mode for 3min)

Efficiency (load >50 % of I <sub>out</sub> max.)	- Normal mode	94 – 98 % (battery charged)
	- Buffer mode	87 – 92 %

### General Specifications

Operating temperature	- Normal Mode	-25°C to +70°C max. (without derating) derating above +50°C : 2.0 %/K derating above +40°C : 2.0 %/K up to +40°C for 10 minutes max. up to +40°C for 3 minutes max.
	- Buffer Mode nominal	
	- Buffer Mode boost	
Storage temperature		-25°C to +85°C max.
Temperature coefficient		0.02 %/K
Humidity (non condensing)		95 % rel. H max.
Reliability, calculated MTBF at +25°C acc. to IEC 61709		> 1.5 Mio. h
Battery protection		against over voltage, deep discharge, overcharge, short circuit and reverse connection (built-in fuse)
Signals	- Status	DC OK input, DC OK output, BAT OK all relay contact closed and LED on at status OK 30 VDC, 1.0 A max. / 60 VDC, 0.5 A max.
	- Contact rating	
Battery charging current		0.8 – 1.2 A
Nominal battery voltage (at 25°C)		13.6 VDC (factory setting)
Battery voltage adjustment range		13.2 – 14.4 VDC
Battery resistance test		100mOhm min. (normal mode at 25°C)
Battery test current		2.5A / 60ms typ. (normal mode at 25°C)
Battery test interval (acc. to jumper setting)		15s or 10min
Battery warning		10.4 – 11.4 VDC (buffer mode only)
Battery disconnection		9.1 – 9.7 VDC (buffer mode only)
Battery remote Off		disconnects battery in buffer mode (see page 6 - connector)
Automatic battery temperature compensation range		-15°C – 50°C
Degree of protection		IP 20 (IEC/EN 60529)
Altitude during operation		2000 m
Safety standard		IEC/EN 60950-1, UL 60950-1 (2nd) + Am1:2011 UL508 – requirements IEC/EN 61010-1, IEC/EN 61010-2-201
Safety approvals	- CSA	UL60950, UL508 IEC 60950-1 (SIQ for EN) IEC/EN 61010-1, IEC/EN 61010-2-201 <a href="http://www.tracopower.com/overview/tsp-bcmu">www.tracopower.com/overview/tsp-bcmu</a>
	- CB test certificate	
	- Certification documents	
Electromagnetic compatibility		in correspondence to connected unit (no internal switching device)
Environment	- Vibration acc. IEC 60068-2-6;	3 axis, sine sweep, 10 – 55 Hz, 1 g, 1 oct/min 3 axis, 15 g half sine, 11 ms
	- Shock acc. IEC 60068-2-27	
Enclosure material		aluminium (chassis) / stainless steel (cover)
Mounting	- DIN-rail mounting	for DIN-rails as per EN 50022-35x15/7.5 (snap-on with self-locking spring) with wall mounting bracket - see page 7
	- Wall mounting (option)	
Connection	- Input Output battery	screw terminal (plug included) detachable screw terminals (plugs included)
	- Signal & control	

All specifications valid at nominal input voltage, full load and +25°C after warm-up time unless otherwise stated.

**Function Specification**

**Function Diagram:**

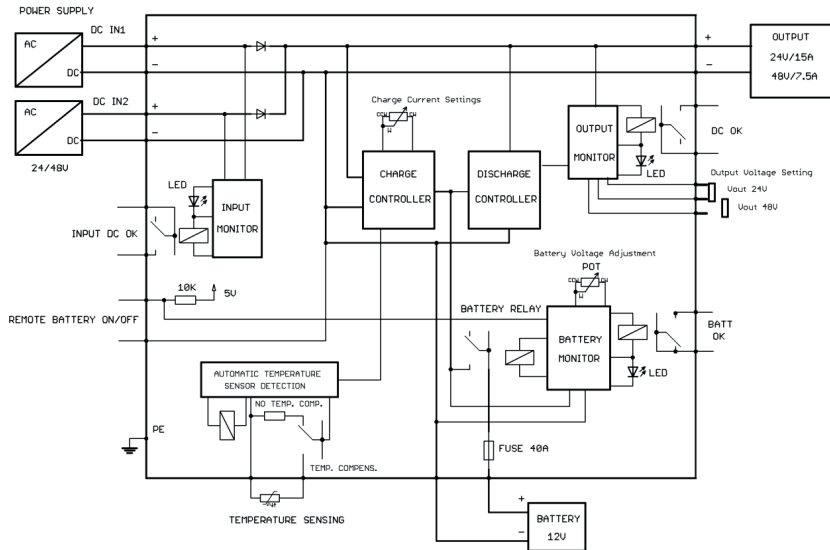

**1. General Description**

The TSP-BCMU360 module extends any 24VDC or 48VDC power supply to a DC-USV (uninterruptable DC Power supply). This module is a standalone unit and is designed to function with the Traco TSP series; however it can be used in conjunction with any fully stabilized 24V or 48V DC power supply output. The set voltage is configured through the means of a jumper on the unit with two selectable DC voltage levels, 24V or 48V. No other signals are required between the TSP-BCMU360 and the connected power supplies for correct operation of the module. In the event of power fail from the connected power supply, the energy required by the load will be supplied continuously and without interruption from an external 12V lead acid battery. The module also offers the unique feature of redundant inputs as well as the battery backup. Redundancy is achieved by two internal decoupling diodes which allow operation with two independent voltage sources in order to increase the reliability of the output even further.

**2. Operation**

**2.1. Battery Backup for USV Operation**

The TSP-BCMU360 module extends any 24VDC or 48VDC power supply to a DC-USV (uninterruptable DC Power supply), this is achieved by the connecting a 12V lead-acid battery to the BATT\_IN connector of the unit. During normal operation, the connected power supply provides energy to load with a voltage level of  $V_{in} - 0.5V$  (typical, 0.5V loss due to internal decoupling diodes) as well as charging the connected battery. If the connected supply fails, the battery is then connected to the load (buffer mode), a step up converter is used to maintain the selected output voltage level,  $V_{nom} - 6%$  (typical).

**2.2. Dual Inputs for Redundancy**

The module provides two inputs to connect two power supplies to facilitate a redundant system. If one of the two connected sources fails then the second supply will provide energy to load maintaining the desired operation of the unit. The unit is designed to function with the TRACO POWER TSP series, but due to its standalone nature it can be used with any type of fully stabilized 24V or 48V power supply.

**2.3. Output Voltage Level and Efficiency**

The TSP-BCMU360 module functions with both 24VDC (15A) and 48VDC (7.5A) supplies. The desired voltage is selectable by means of a jumper located on the side of the unit. It also offers very high efficiencies with up to 96% and 98% efficiency in normal mode for 24V and 48V modes respectively. In the buffer mode efficiencies are as high as 92% and 89% for 24V and 48V modes respectively.

**Function Specification (continued)**

**3. Battery**

When the input DC voltage is present, the TSP-BCMU360 unit will automatically charge the connected battery to a set end of battery charge voltage level, factory set for 25°C for lead-acid batteries, using a constant current charging method of 1A (typical). As the battery voltage approaches the end of battery charge voltage level, the current will decrease proportionality; this characteristic is shown in Figure 1. The user can adjust the set end of battery charge voltage level by means of the "Battery Voltage Adjust" potentiometer.

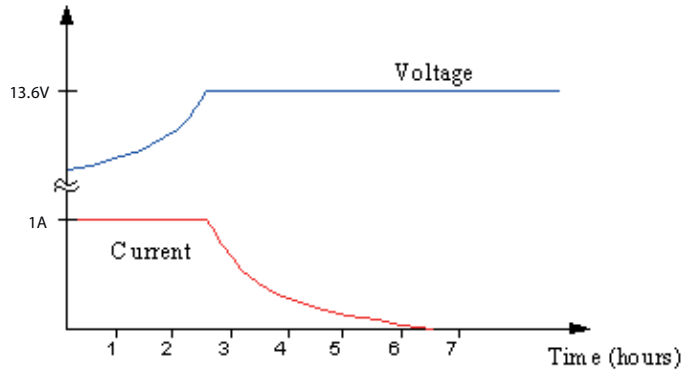

Figure 1 – Battery Charge Characteristics

**Note: For Cycle Use (repeated charging and discharging of battery), it is recommended to use a charge current of 0.4CA or smaller, therefore batteries with a capacity of 2.5Ah or less should not be used with this module.**

The module also provides an input connector for a temperature compensation probe. If this probe is connected, the unit will automatically compensate the end of battery charge voltage level depending on the measured temperature. The connection of the temperature probe also negates the need to change the potentiometer to compensate for a new temperature. The battery end voltage compensation curve is shown in Figure 2. (Applicable to factory setting of 13.6V/ 25°C)

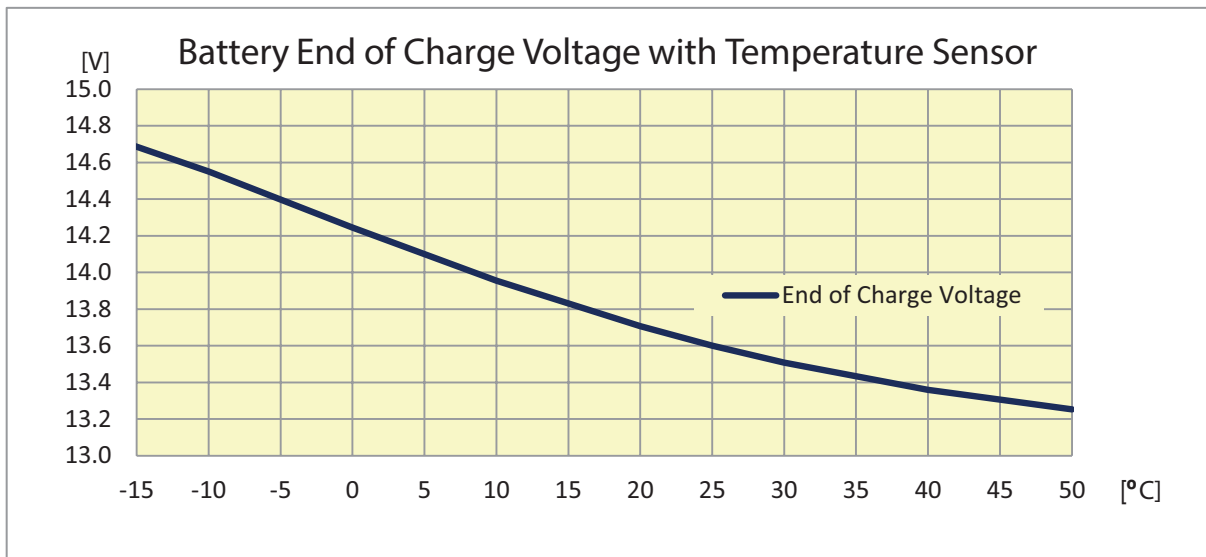

Figure 2

**3.1 Battery Protection**

The TSP-BCMU360 module protects the connected battery against short circuit and overload by the means of a built in 40A fuse. This fuse is a standard 40A blade type fuse, which is accessible from the front panel of the unit for ease of replacement should the fuse be damaged during operation. The module also prevents deep discharge of the battery by disconnecting the battery from the load once the voltage level of battery has dropped below a defined threshold. An early warning of this disconnection is given to the user by means of the BATT-OK signal (see chapter 6). The BATT-OK signal will switch off when the battery voltage is roughly 1V above the deep discharge threshold.

**Function Specification (continued)**

**4. Ambient temperature and power rating**

The TSP-BCMU360 module operates at temperatures between  $-25^{\circ}\text{C}$  -  $70^{\circ}\text{C}$ . In normal mode the module can deliver full power up to  $60^{\circ}\text{C}$ . In Buffer mode, a current derating of  $2\%/^{\circ}\text{C}$  is required for 24V applications above  $50^{\circ}\text{C}$ . The boost current of 15A is available at ambient temperatures up to  $40^{\circ}\text{C}$  for a duration of 10 minutes as shown in Figure 3. In Buffer mode, a current derating of  $2\%/^{\circ}\text{C}$  is required for 48V applications above  $40^{\circ}\text{C}$ . The boost current of 7.5A is available at ambient temperatures up to  $40^{\circ}\text{C}$  for a duration of 3 minutes as shown in Figure 4 (minimum start-up temperature in buffer mode is  $-10^{\circ}\text{C}$ ).

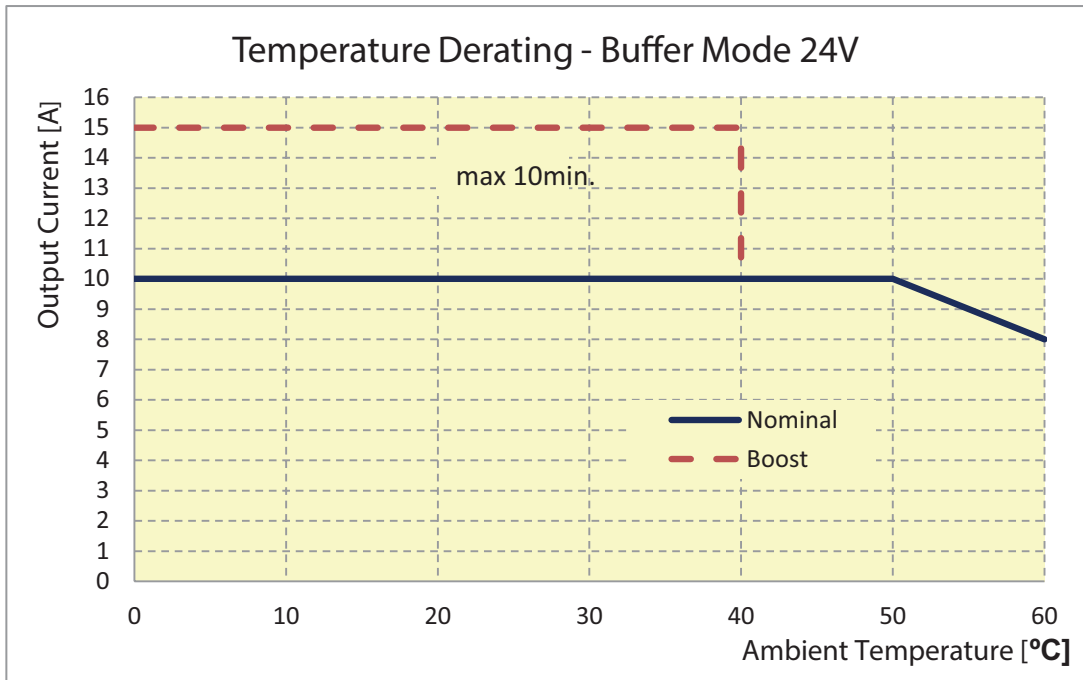

Figure 3

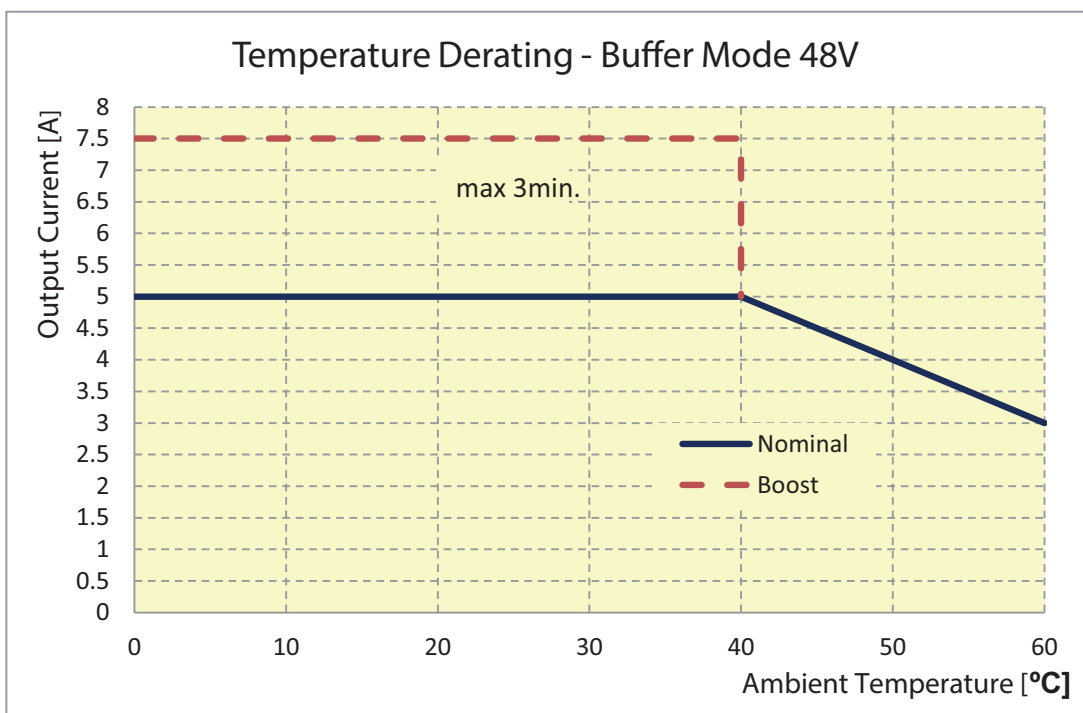
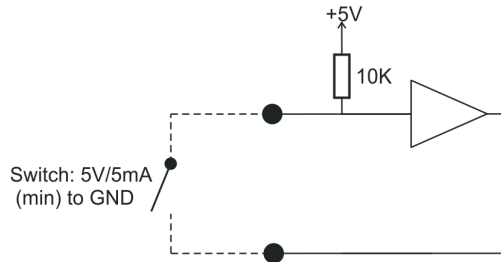

Figure 4

**Function Specification (continued)**

**5. Battery Remote On/Off**

The TSP-BCMU360 module provides a Battery Remote on/off input (2 pins on signal connector); if this input is short circuited (switch closed in *Figure 5*) the battery will be disconnected from the unit by means of an internal relay. A voltage of 1V or less across the Battery Remote on/off terminals will disconnect the battery from the unit. If the Battery Remote On/Off signal is set to off (short between pins) this will not affect the output of the unit in normal mode, however the battery will be disconnected, hence it will not charge. If the unit enters buffer mode while the Battery Remote On/Off signal is off, the battery will remain disconnected, hence no energy will be supplied to the load.



*Figure 5 – Simplified Battery Remote On/Off Circuitry*

An overview of the Battery Remote on/off input is given in the table below.

Battery State	Battery Remote On/Off Pins	Voltage
Connected	Open Circuit	5V
Disconnected	Short Circuit	<1V

**6. Signals**

The TSP-BCMU360 module provides three signals to the user as an indication of the status of the unit; these signals are made available as LED indicators and corresponding isolated relay contacts and are as follows.

**Note: All Signal Relay contacts are rated for 30VDC/1A, 60VDC/0.5A**

- DC-IN-OK: The DC-IN-OK LED will illuminate and relay will close if at least one of the inputs is present and has a voltage within +20 / -3% tolerance.
- BATT-OK: The BATT-OK LED will illuminate and relay will close if the battery is charged and has a low internal resistance. During battery discharge operation this signal monitors the output voltage and will switch off the LED and open the relay when the battery approaches the disconnection voltage.
- DC-OUT-OK: The DC-OUT-OK LED will illuminate and relay will close if the output voltage of the unit is higher than 85-90% of the nominal output voltage.

All specifications valid at nominal input voltage, full load and +25°C after warm-up time unless otherwise stated.

**Connector Position**

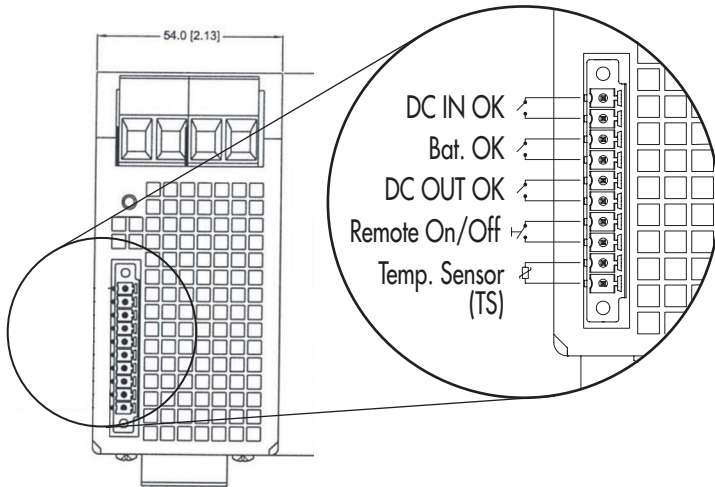

**Remote On/Off**

Recommended switch specifications for operation with a switch:  
**5V / 5mA**

For direct pulldown operation, the voltage level has to be **<1.0V**

**Configuration Pins**

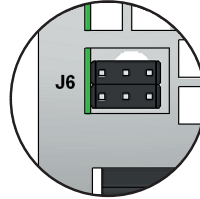

**Factory Settings**

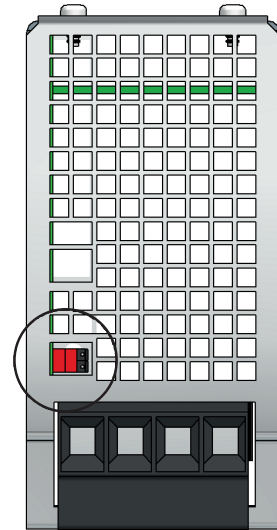
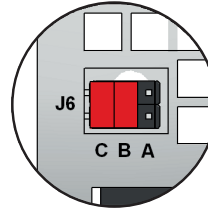

- A: Battery test period 10 min (not fitted, default); 15 sec (fitted)
- B: Output voltage settings 48 V (not fitted); 24 V (fitted, default)
- C: Not in use (spare jumper fitted)

**Outline Dimensions**

