

## 3A, 45V - 60V Low $V_F$ Trench Schottky Surface Mount Rectifier

### FEATURES

- Patented Trench Schottky technology
- Excellent high temperature stability
- Low forward voltage
- Lower power loss/ high efficiency
- High forward surge capability
- Moisture sensitivity level: level 1, per J-STD-020
- RoHS Compliant
- Halogen-free according to IEC 61249-2-21

### APPLICATIONS

- Switching mode power supply (SMPS)
- Adapters
- DC to DC converters

### MECHANICAL DATA

- Case: SOD-123W
- Molding compound meets UL 94V-0 flammability rating
- Terminal: Matte tin plated leads, solderable per J-STD-002
- Meet JESD 201 class 2 whisker test
- Polarity: Indicated by cathode band
- Weight: 0.016g (approximately)

KEY PARAMETERS		
PARAMETER	VALUE	UNIT
$I_F$	3	A
$V_{RRM}$	45 - 60	V
$I_{FSM}$	50	A
$T_{JMAX}$	150	°C
Package	SOD-123W	
Configuration	Single die	

**SOD-123W**

ABSOLUTE MAXIMUM RATINGS ( $T_A = 25^\circ\text{C}$ unless otherwise noted)				
PARAMETER	SYMBOL	TSSW3U45	TSSW3U60	UNIT
Marking code on the device		W3U45	W3U60	
Repetitive peak reverse voltage	$V_{RRM}$	45	60	V
Reverse voltage, total rms value	$V_{R(RMS)}$	31	42	V
Forward current	$I_F$	3		A
Peak forward surge current, 8.3ms single half sine-wave superimposed on rated load	$I_{FSM}$	50		A
Junction temperature	$T_J$	- 55 to +150		°C
Storage temperature	$T_{STG}$	- 55 to +150		°C

**THERMAL PERFORMANCE**

PARAMETER	SYMBOL	TYP	UNIT
Junction-to-lead thermal resistance	$R_{\theta JL}$	20	°C/W
Junction-to-ambient thermal resistance	$R_{\theta JA}$	75	°C/W

**ELECTRICAL SPECIFICATIONS** ( $T_A = 25^\circ\text{C}$  unless otherwise noted)

PARAMETER	CONDITIONS	SYMBOL	TYP	MAX	UNIT	
Forward voltage <sup>(1)</sup>	$I_F = 1\text{A}, T_J = 25^\circ\text{C}$	$V_F$	0.33	-	V	
			TSSW3U60	0.39	-	V
	$I_F = 3\text{A}, T_J = 25^\circ\text{C}$		TSSW3U45	0.40	0.47	V
			TSSW3U60	0.49	0.58	V
	$I_F = 1\text{A}, T_J = 125^\circ\text{C}$		TSSW3U45	0.24	-	V
			TSSW3U60	0.28	-	V
	$I_F = 3\text{A}, T_J = 125^\circ\text{C}$		TSSW3U45	0.34	0.44	V
			TSSW3U60	0.43	0.52	V
Reverse current @ rated $V_R$ <sup>(2)</sup>	$T_J = 25^\circ\text{C}$	$I_R$	-	1	mA	
	$T_J = 125^\circ\text{C}$		-	50	mA	

**Notes:**

1. Pulse test with  $PW = 0.3\text{ms}$
2. Pulse test with  $PW = 30\text{ms}$

**ORDERING INFORMATION**

ORDERING CODE <sup>(1)</sup>	PACKAGE	PACKING
TSSW3Ux	SOD-123W	10,000 / Tape & Reel

**Notes:**

1. "x" defines voltage from 45V(TSSW3U45) to 60V(TSSW3U60)

**CHARACTERISTICS CURVES**

( $T_A = 25^\circ\text{C}$  unless otherwise noted)

**Fig.1 Forward Current Derating Curve**

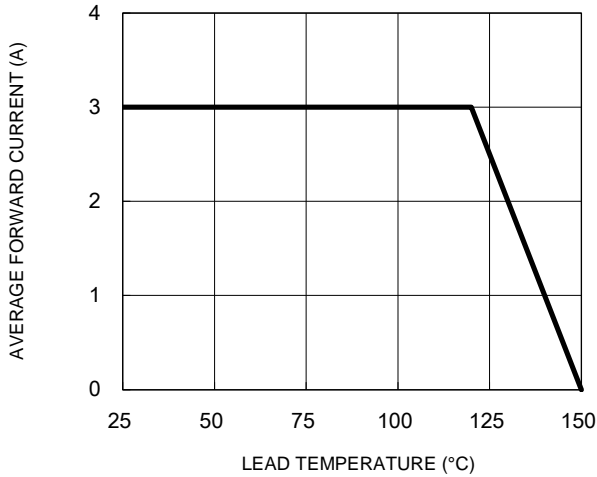

**Fig.2 Typical Junction Capacitance**

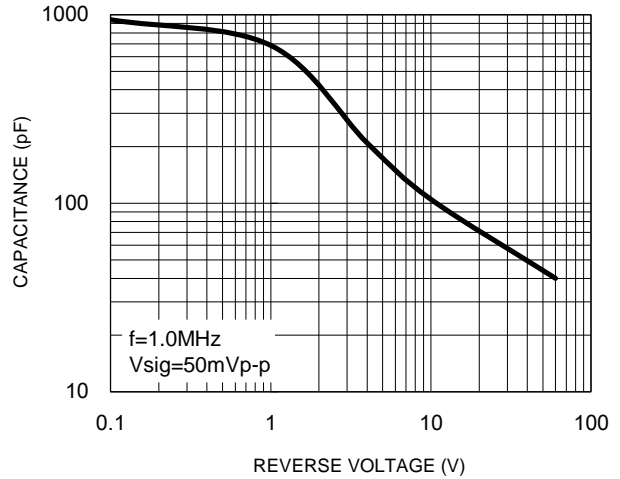

**Fig.3 Typical Reverse Characteristics**

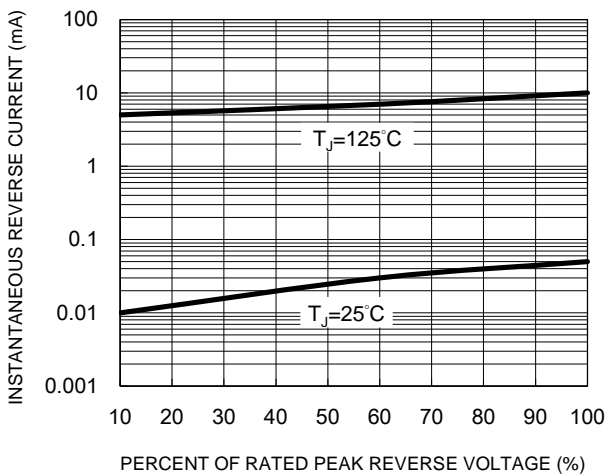

**Fig.4 Typical Forward Characteristics**

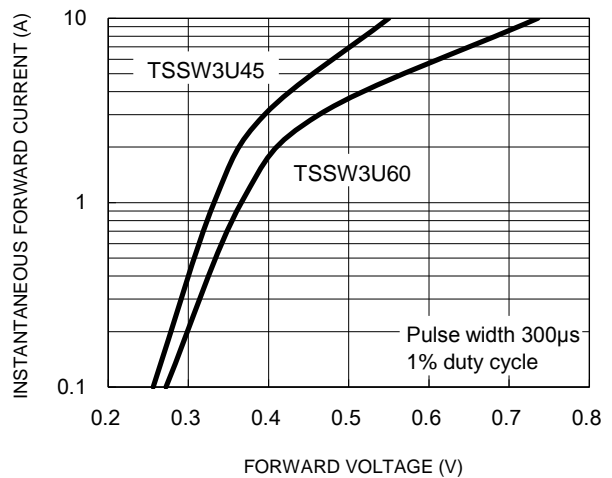

**Fig.5 Maximum Non-Repetitive Forward Surge Current**

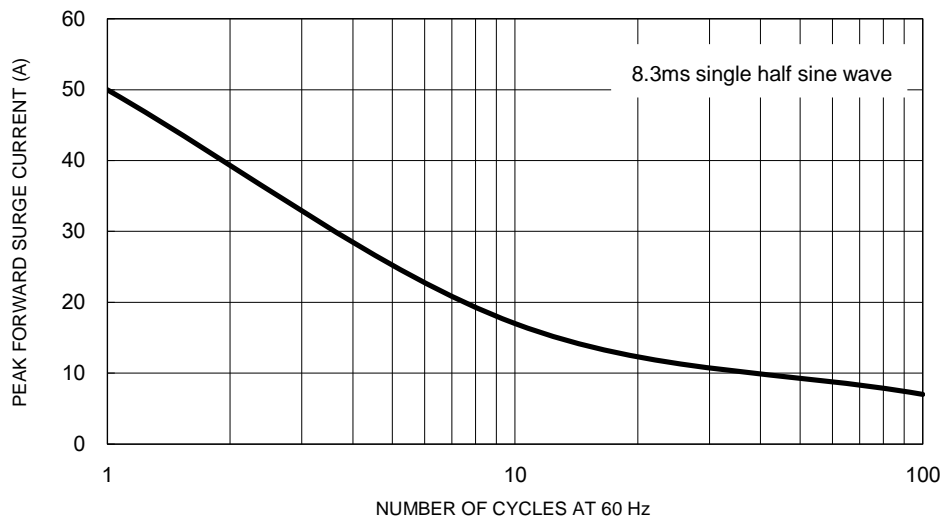

**PACKAGE OUTLINE DIMENSIONS**

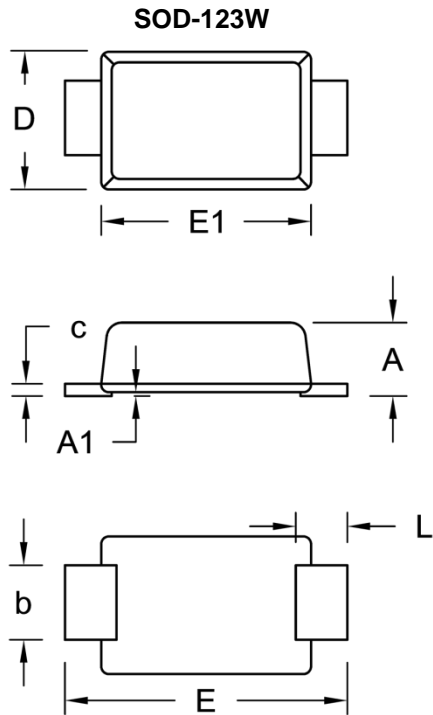

DIM.	Unit (mm)		Unit (inch)	
	Min.	Max.	Min.	Max.
A	0.90	1.02	0.035	0.040
A1	0.00	0.10	0.000	0.004
b	0.90	1.05	0.035	0.041
c	0.10	0.22	0.004	0.009
D	1.70	1.90	0.067	0.075
E	3.60	3.80	0.142	0.150
E1	2.60	2.90	0.102	0.114
L	0.50	0.85	0.020	0.033

**SUGGESTED PAD LAYOUT**

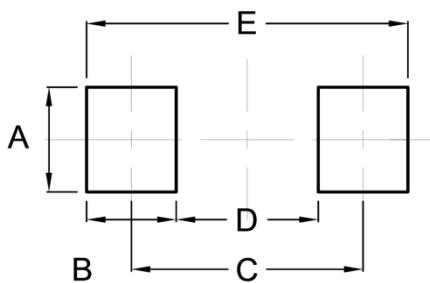

Symbol	Unit (mm)	Unit (inch)
A	1.40	0.055
B	1.20	0.047
C	3.10	0.122
D	1.90	0.075
E	4.30	0.169

**MARKING DIAGRAM**



P/N = Marking Code  
 YW = Date Code  
 F = Factory Code