

3A, 45V - 60V Low V_F Trench Schottky Surface Mount Rectifier

FEATURES

- Patented Trench Schottky technology
- Excellent high temperature stability
- Low forward voltage
- Lower power loss/ high efficiency
- High forward surge capability
- Moisture sensitivity level: level 1, per J-STD-020
- RoHS Compliant
- Halogen-free according to IEC 61249-2-21

APPLICATIONS

- Switching mode power supply (SMPS)
- Adapters
- DC to DC converters

MECHANICAL DATA

- Case: SOD-123W
- Molding compound meets UL 94V-0 flammability rating
- Terminal: Matte tin plated leads, solderable per J-STD-002
- Meet JESD 201 class 2 whisker test
- Polarity: Indicated by cathode band
- Weight: 0.016g (approximately)

KEY PARAMETERS		
PARAMETER	VALUE	UNIT
I_F	3	A
V_{RRM}	45 - 60	V
I_{FSM}	50	A
T_{JMAX}	150	°C
Package	SOD-123W	
Configuration	Single die	

SOD-123W

ABSOLUTE MAXIMUM RATINGS ($T_A = 25^\circ\text{C}$ unless otherwise noted)				
PARAMETER	SYMBOL	TSSW3U45	TSSW3U60	UNIT
Marking code on the device		W3U45	W3U60	
Repetitive peak reverse voltage	V_{RRM}	45	60	V
Reverse voltage, total rms value	$V_{R(RMS)}$	31	42	V
Forward current	I_F	3		A
Peak forward surge current, 8.3ms single half sine-wave superimposed on rated load	I_{FSM}	50		A
Junction temperature	T_J	- 55 to +150		°C
Storage temperature	T_{STG}	- 55 to +150		°C

THERMAL PERFORMANCE

PARAMETER	SYMBOL	TYP	UNIT
Junction-to-lead thermal resistance	$R_{\theta JL}$	20	°C/W
Junction-to-ambient thermal resistance	$R_{\theta JA}$	75	°C/W

ELECTRICAL SPECIFICATIONS ($T_A = 25^\circ\text{C}$ unless otherwise noted)

PARAMETER	CONDITIONS	SYMBOL	TYP	MAX	UNIT	
Forward voltage ⁽¹⁾	$I_F = 1\text{A}, T_J = 25^\circ\text{C}$	V_F	0.33	-	V	
			TSSW3U60	0.39	-	V
	$I_F = 3\text{A}, T_J = 25^\circ\text{C}$		TSSW3U45	0.40	0.47	V
			TSSW3U60	0.49	0.58	V
	$I_F = 1\text{A}, T_J = 125^\circ\text{C}$		TSSW3U45	0.24	-	V
			TSSW3U60	0.28	-	V
	$I_F = 3\text{A}, T_J = 125^\circ\text{C}$		TSSW3U45	0.34	0.44	V
			TSSW3U60	0.43	0.52	V
Reverse current @ rated V_R ⁽²⁾	$T_J = 25^\circ\text{C}$	I_R	-	1	mA	
	$T_J = 125^\circ\text{C}$		-	50	mA	

Notes:

1. Pulse test with $PW = 0.3\text{ms}$
2. Pulse test with $PW = 30\text{ms}$

ORDERING INFORMATION

ORDERING CODE ⁽¹⁾	PACKAGE	PACKING
TSSW3Ux	SOD-123W	10,000 / Tape & Reel

Notes:

1. "x" defines voltage from 45V(TSSW3U45) to 60V(TSSW3U60)

CHARACTERISTICS CURVES

($T_A = 25^\circ\text{C}$ unless otherwise noted)

Fig.1 Forward Current Derating Curve

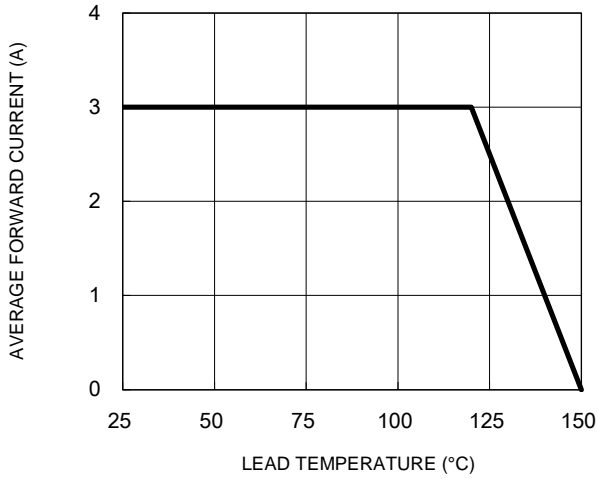

Fig.2 Typical Junction Capacitance

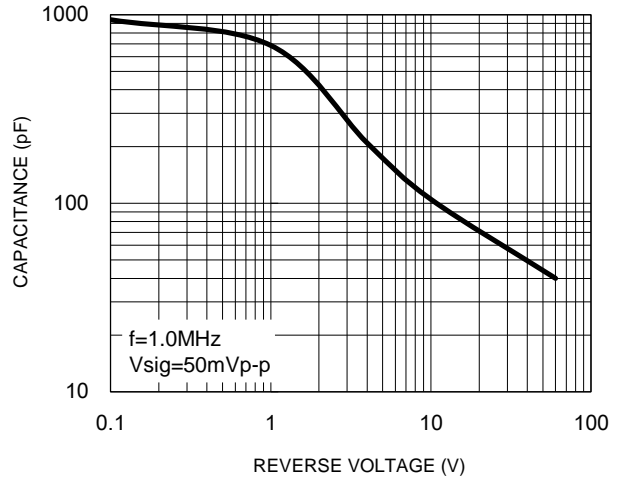

Fig.3 Typical Reverse Characteristics

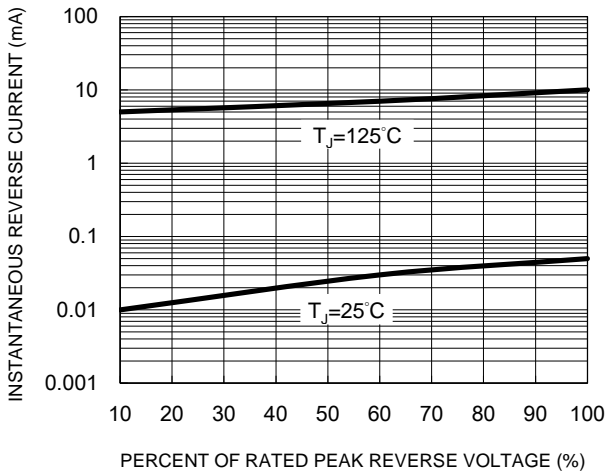

Fig.4 Typical Forward Characteristics

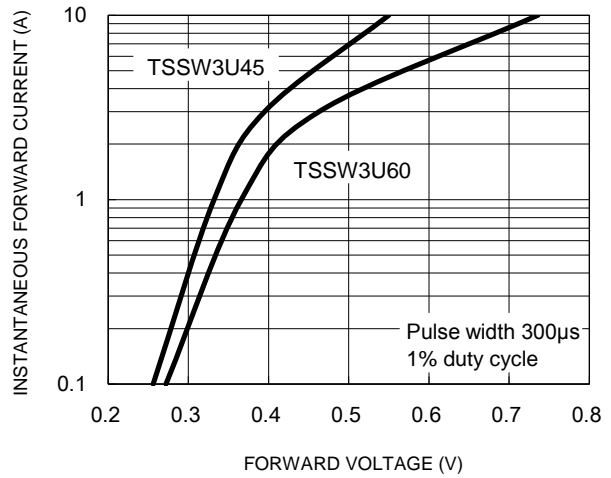
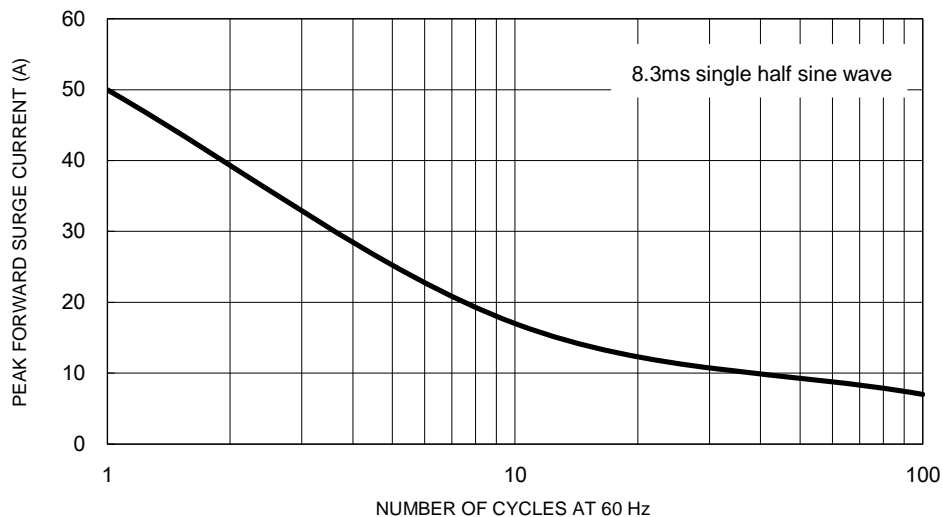
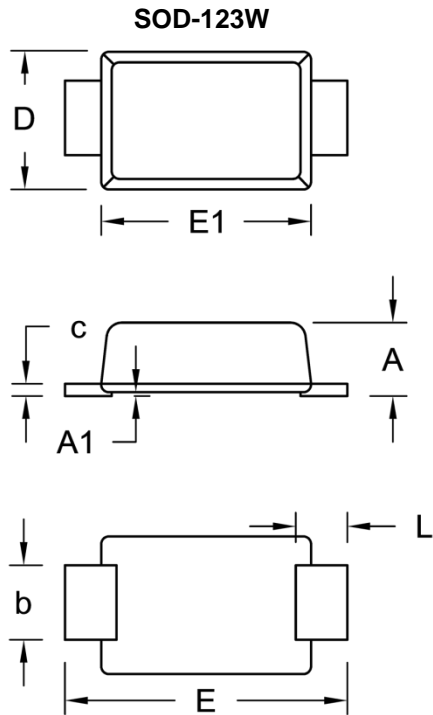

Fig.5 Maximum Non-Repetitive Forward Surge Current



PACKAGE OUTLINE DIMENSIONS



DIM.	Unit (mm)		Unit (inch)	
	Min.	Max.	Min.	Max.
A	0.90	1.02	0.035	0.040
A1	0.00	0.10	0.000	0.004
b	0.90	1.05	0.035	0.041
c	0.10	0.22	0.004	0.009
D	1.70	1.90	0.067	0.075
E	3.60	3.80	0.142	0.150
E1	2.60	2.90	0.102	0.114
L	0.50	0.85	0.020	0.033

SUGGESTED PAD LAYOUT

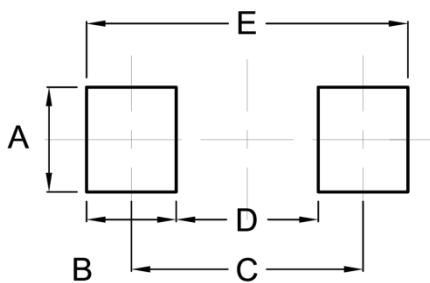

Symbol	Unit (mm)	Unit (inch)
A	1.40	0.055
B	1.20	0.047
C	3.10	0.122
D	1.90	0.075
E	4.30	0.169

MARKING DIAGRAM



P/N = Marking Code
 YW = Date Code
 F = Factory Code