

Rail-to-rail input/output 10 μ A, 120 kHz CMOS operational amplifiers

Datasheet - production data

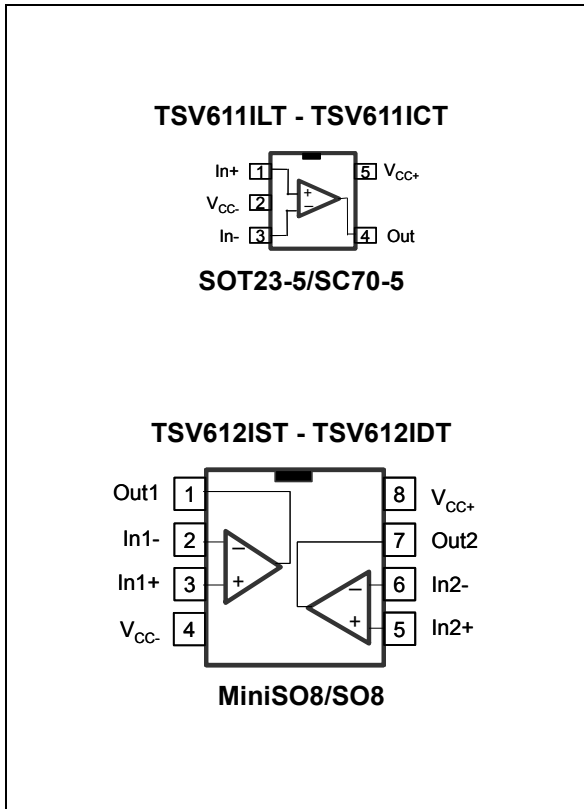

Applications

- Battery-powered applications
- Smoke detectors
- Proximity sensors
- Portable devices
- Signal conditioning
- Active filtering
- Medical instrumentation

Description

The TSV61x family of single and dual operational amplifiers offers low voltage, low power operation, and rail-to-rail input and output.

The devices also feature an ultra-low input bias current as well as a low input offset voltage.

The TSV61x have a gain bandwidth product of 120 kHz while consuming only 10 μ A at 5 V.

These features make the TSV61x family ideal for sensor interfaces, battery supplied and portable applications, as well as active filtering.

Features

- Rail-to-rail input and output
- Low power consumption: 10 μ A typ at 5 V
- Low supply voltage: 1.5 to 5.5 V
- Gain bandwidth product: 120 kHz typ
- Unity gain stable
- Low input offset voltage: 800 μ V max (A version)
- Low input bias current: 1 pA typ
- Temperature range: -40 to 85 $^{\circ}$ C

Contents

- 1 Absolute maximum ratings and operating conditions 3**
- 2 Electrical characteristics 4**
- 3 Application information 12**
 - 3.1 Operating voltages 12
 - 3.2 Rail-to-rail input 12
 - 3.3 Rail-to-rail output 12
 - 3.4 Driving resistive and capacitive loads 13
 - 3.5 PCB layouts 13
 - 3.6 Macromodel 13
- 4 Package information 14**
 - 4.1 SOT23-5 package information 15
 - 4.2 SC70-5 (SOT323-5) package information 16
 - 4.3 SO8 package information 17
 - 4.4 MiniSO8 package information 18
- 5 Ordering information 19**
- 6 Revision history 20**

1 Absolute maximum ratings and operating conditions

Table 1. Absolute maximum ratings

Symbol	Parameter	Value	Unit
V_{CC}	Supply voltage ⁽¹⁾	6	V
V_{id}	Differential input voltage ⁽²⁾	$\pm V_{CC}$	
V_{in}	Input voltage ⁽³⁾	$(V_{CC-}) - 0.2$ to $(V_{CC+}) + 0.2$	
T_{stg}	Storage temperature	-65 to 150	°C
R_{thja}	Thermal resistance junction to ambient ^{(4) (5)}		°C/W
	SC70-5	205	
	SOT23-5	250	
	MiniSO8	190	
	SO8	125	
T_j	Maximum junction temperature	150	°C
ESD	HBM: human body model ⁽⁶⁾	4	kV
	MM: machine model ⁽⁷⁾	200	V
	CDM: charged device model ⁽⁸⁾	1.5	kV
	Latch-up immunity	200	mA

- All voltage values, except differential voltage are with respect to network ground terminal.
- Differential voltages are the non-inverting input terminal with respect to the inverting input terminal.
- V_{CC} - V_{in} must not exceed 6 V.
- Short-circuits can cause excessive heating and destructive dissipation.
- R_{th} are typical values.
- Human body model: 100 pF discharged through a 1.5 k Ω resistor between two pins of the device, done for all couples of pin combinations with other pins floating.
- Machine model: a 200 pF cap is charged to the specified voltage, then discharged directly between two pins of the device with no external series resistor (internal resistor < 5 Ω), done for all couples of pin combinations with other pins floating.
- Charged device model: all pins plus package are charged together to the specified voltage and then discharged directly to ground.

Table 2. Operating conditions

Symbol	Parameter	Value	Unit
V_{CC}	Supply voltage	1.5 to 5.5	V
V_{icm}	Common mode input voltage range	$(V_{CC-}) - 0.1$ to $(V_{CC+}) + 0.1$	
T_{oper}	Operating free air temperature range	-40 to 85	°C

2 Electrical characteristics

Table 3. Electrical characteristics at $V_{CC+} = 1.8\text{ V}$ with $V_{CC-} = 0\text{ V}$, $V_{icm} = V_{CC}/2$, $T_{amb} = 25\text{ °C}$, and R_L connected to $V_{CC}/2$ (unless otherwise specified)

Symbol	Parameter	Conditions	Min.	Typ.	Max.	Unit
DC performance						
V_{io}	Offset voltage	TSV61x			4	mV
		TSV61xA			0.8	
		$T_{min.} < T_{op} < T_{max.}$ TSV61x			5	
		$T_{min.} < T_{op} < T_{max.}$ TSV61xA			2	
$\Delta V_{io}/\Delta T$	Input offset voltage drift			2		$\mu\text{V}/\text{°C}$
I_{io}	Input offset current ($V_{out} = V_{CC}/2$)			1	$10^{(1)}$	pA
		$T_{min.} < T_{op} < T_{max.}$		1	100	
I_{ib}	Input bias current ($V_{out} = V_{CC}/2$)			1	$10^{(1)}$	pA
		$T_{min.} < T_{op} < T_{max.}$		1	100	
CMR	Common mode rejection ratio $20 \log(\Delta V_{ic}/\Delta V_{io})$	$0\text{ V to }1.8\text{ V}$, $V_{out} = 0.9\text{ V}$	55	71		dB
		$T_{min.} < T_{op} < T_{max.}$	53			
A_{vd}	Large signal voltage gain	$R_L = 10\text{ k}\Omega$, $V_{out} = 0.5\text{ V to }1.3\text{ V}$	78	83		dB
		$T_{min.} < T_{op} < T_{max.}$	74			
V_{OH}	High level output voltage ($V_{OH} = V_{CC} - V_{out}$)	$R_L = 10\text{ k}\Omega$ $T_{min.} < T_{op} < T_{max.}$		4	35 50	mV
V_{OL}	Low level output voltage	$R_L = 10\text{ k}\Omega$ $T_{min.} < T_{op} < T_{max.}$		7	35 50	
I_{out}	Isink	$V_o = 1.8\text{ V}$ $T_{min.} < T_{op} < T_{max.}$	9 9	13		mA
	Isource	$V_o = 0\text{ V}$ $T_{min.} < T_{op} < T_{max.}$	8 8	10		
I_{CC}	Supply current (per operator)	No load, $V_{out} = V_{CC}/2$	6.5	9	12	μA
		$T_{min.} < T_{op} < T_{max.}$	6		12.5	
AC performance						
GBP	Gain bandwidth product			100		kHz
ϕ_m	Phase margin	$R_L = 10\text{ k}\Omega$, $C_L = 20\text{ pF}$		60		Degrees
G_m	Gain margin			9.5		dB
SR	Slew rate	$R_L = 10\text{ k}\Omega$, $C_L = 20\text{ pF}$, $V_{out} = 0.5\text{ V to }1.3\text{ V}$		0.03		$\text{V}/\mu\text{s}$

Table 3. Electrical characteristics at $V_{CC+} = 1.8\text{ V}$ with $V_{CC-} = 0\text{ V}$, $V_{icm} = V_{CC}/2$, $T_{amb} = 25\text{ °C}$, and R_L connected to $V_{CC}/2$ (unless otherwise specified) (continued)

Symbol	Parameter	Conditions	Min.	Typ.	Max.	Unit
e_n	Equivalent input noise voltage	$f = 1\text{ kHz}$		110		$\frac{nV}{\sqrt{Hz}}$
THD+N	Total harmonic distortion + noise	$F_{in} = 1\text{ kHz}$, $A_v = 1$, $V_{out} = 1\text{ V}_{pp}$, $R_L = 100\text{ k}\Omega$, $BW = 22\text{ kHz}$		0.07		%

1. Guaranteed by design.

Table 4. Electrical characteristics at $V_{CC+} = 3.3\text{ V}$, $V_{CC-} = 0\text{ V}$, $V_{icm} = V_{CC}/2$, $T_{amb} = 25\text{ }^\circ\text{C}$, R_L connected to $V_{CC}/2$ (unless otherwise specified)

Symbol	Parameter		Min.	Typ.	Max.	Unit
DC performance						
V_{io}	Offset voltage	TSV61x			4	mV
		TSV61xA			0.8	
		$T_{min} < T_{op} < T_{max}$ TSV61x			5	
		$T_{min} < T_{op} < T_{max}$ TSV61xA			2	
$\Delta V_{io}/\Delta T$	Input offset voltage drift			2		$\mu\text{V}/^\circ\text{C}$
I_{io}	Input offset current			1	$10^{(1)}$	pA
		$T_{min.} < T_{op} < T_{max.}$		1	100	
I_{ib}	Input bias current			1	$10^{(1)}$	pA
		$T_{min.} < T_{op} < T_{max.}$		1	100	
CMR	Common mode rejection ratio $20 \log (\Delta V_{ic}/\Delta V_{io})$	0 V to 3.3 V, $V_{out} = 1.75\text{ V}$	61	76		dB
		$T_{min.} < T_{op} < T_{max.}$	58			
A_{vd}	Large signal voltage gain	$R_L = 10\text{ k}\Omega$, $V_{out} = 0.5\text{ V}$ to 2.8 V	85	92		dB
		$T_{min.} < T_{op} < T_{max.}$	83			
V_{OH}	High level output voltage ($V_{OH} = V_{CC} - V_{out}$)	$R_L = 10\text{ k}\Omega$ $T_{min.} < T_{op} < T_{max.}$		5	35 50	mV
V_{OL}	Low level output voltage	$R_L = 10\text{ k}\Omega$ $T_{min.} < T_{op} < T_{max.}$		10	35 50	
I_{out}	Isink	$V_o = V_{CC}$ $T_{min.} < T_{op} < T_{max.}$	37 35	44		mA
	Isource	$V_o = 0\text{ V}$ $T_{min.} < T_{op} < T_{max.}$	32 30	38		
I_{CC}	Supply current (per operator)	No load, $V_{out} = V_{CC}/2$	6.5	9.5	12.5	μA
		$T_{min.} < T_{op} < T_{max.}$	6		13	
AC performance						
GBP	Gain bandwidth product			110		kHz
ϕ_m	Phase margin	$R_L = 10\text{ k}\Omega$, $C_L = 20\text{ pF}$		60		Degrees
G_m	Gain margin			9.5		dB
SR	Slew rate	$R_L = 10\text{ k}\Omega$, $C_L = 20\text{ pF}$, $V_{out} = 0.5\text{ V}$ to 2.8 V		0.035		$\text{V}/\mu\text{s}$
e_n	Equivalent input noise voltage	$f = 1\text{ kHz}$		110		$\frac{\text{nV}}{\sqrt{\text{Hz}}}$

1. Guaranteed by design.

Table 5. Electrical characteristics at $V_{CC+} = 5\text{ V}$, $V_{CC-} = 0\text{ V}$, $V_{icm} = V_{CC}/2$, $T_{amb} = 25\text{ }^{\circ}\text{C}$, R_L connected to $V_{CC}/2$ (unless otherwise specified)

Symbol	Parameter		Min.	Typ.	Max.	Unit
DC performance						
V_{io}	Offset voltage	TSV61x			4	mV
		TSV61xA			0.8	
		$T_{min} < T_{op} < T_{max}$ TSV61x			5	
		$T_{min} < T_{op} < T_{max}$ TSV61xA			2	
$\Delta V_{io}/\Delta T$	Input offset voltage drift			2		$\mu\text{V}/^{\circ}\text{C}$
I_{io}	Input offset current			1	10 ⁽¹⁾	pA
		$T_{min} < T_{op} < T_{max}$.		1	100	
I_{ib}	Input bias current			1	10 ⁽¹⁾	pA
		$T_{min} < T_{op} < T_{max}$.		1	100	
CMR	Common mode rejection ratio $20 \log (\Delta V_{ic}/\Delta V_{io})$	0 V to 5 V, $V_{out} = 2.5\text{ V}$	64	80		dB
		$T_{min} < T_{op} < T_{max}$.	63			
SVR	Supply voltage rejection ratio $20 \log (\Delta V_{cc}/\Delta V_{io})$	$V_{cc} = 1.8\text{ to }5\text{ V}$	76	93		dB
		$T_{min} < T_{op} < T_{max}$.	74			
A_{vd}	Large signal voltage gain	$R_L = 10\text{ k}\Omega$, $V_{out} = 0.5\text{ V to }4.5\text{ V}$	88	93		dB
		$T_{min} < T_{op} < T_{max}$	85			
V_{OH}	High level output voltage ($V_{OH} = V_{CC} - V_{out}$)	$R_L = 10\text{ k}\Omega$ $T_{min} < T_{op} < T_{max}$.		7	35 50	mV
V_{OL}	Low level output voltage	$R_L = 10\text{ k}\Omega$ $T_{min} < T_{op} < T_{max}$.		16	35 50	
I_{out}	Isink	$V_o = V_{CC}$ $T_{min} < T_{op} < T_{max}$.	52 42	57		mA
	Isource	$V_o = 0\text{ V}$ $T_{min} < T_{op} < T_{max}$.	58 49	63		
I_{CC}	Supply current (per operator)	No load, $V_{out} = V_{CC}/2$	7.5	10.5	14	μA
		$T_{min} < T_{op} < T_{max}$.	7		15	
AC performance						
GBP	Gain bandwidth product			120		kHz
ϕ_m	Phase margin	$R_L = 10\text{ k}\Omega$, $C_L = 20\text{ pF}$		62		Degrees
G_m	Gain margin			10		dB
SR	Slew rate	$R_L = 10\text{ k}\Omega$, $C_L = 20\text{ pF}$, $V_{out} = 0.5\text{V to }4.5\text{V}$		0.04		V/ μs

Table 5. Electrical characteristics at $V_{CC+} = 5\text{ V}$, $V_{CC-} = 0\text{ V}$, $V_{icm} = V_{CC}/2$, $T_{amb} = 25\text{ °C}$, R_L connected to $V_{CC}/2$ (unless otherwise specified) (continued)

Symbol	Parameter		Min.	Typ.	Max.	Unit
e_n	Equivalent input noise voltage	$f = 1\text{ kHz}$		105		$\frac{nV}{\sqrt{Hz}}$
THD+N	Total harmonic distortion + noise	$F_{in} = 1\text{ kHz}$, $A_v = 1$, $V_{out} = 1\text{ V}_{pp}$, $R_L = 100\text{ k}\Omega$, $BW = 22\text{ kHz}$		0.02		%

1. Guaranteed by design.

Figure 1. Supply current vs. supply voltage at $V_{icm} = V_{CC}/2$



Figure 2. Output current vs. output voltage at $V_{CC} = 1.5V$

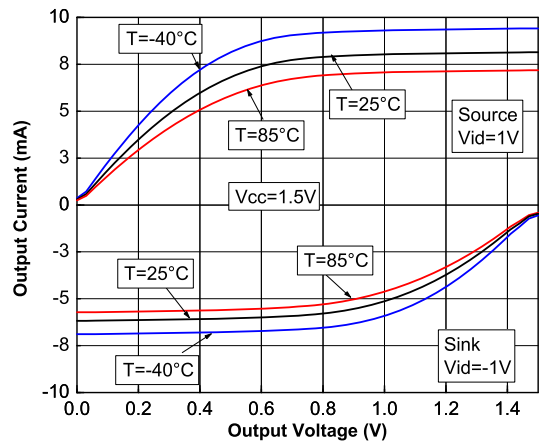

Figure 3. Output current vs. output voltage at $V_{CC} = 5V$

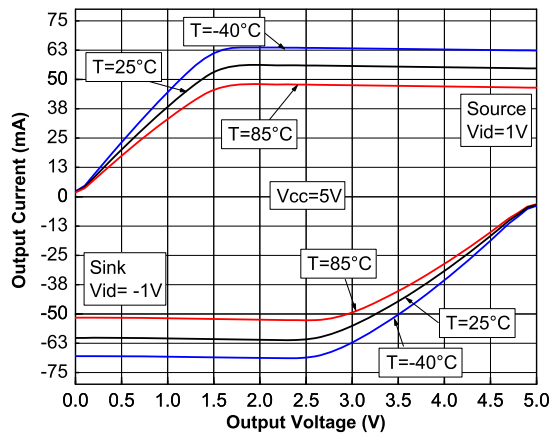

Figure 4. Voltage gain and phase vs. frequency at $V_{CC} = 1.5V$



Figure 5. Voltage gain and phase vs. frequency at $V_{CC} = 5V$



Figure 6. Phase margin vs. output current



Figure 7. Positive slew rate vs. time, $V_{CC} = 1.5\text{ V}$, $C_{Load} = 100\text{ pF}$, $R_{Load} = 10\text{ k}\Omega$

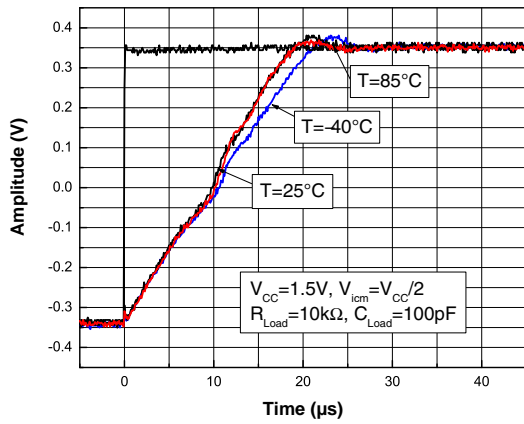

Figure 8. Negative slew rate vs. time, $V_{CC} = 1.5\text{ V}$, $C_{Load} = 100\text{ pF}$, $R_{Load} = 10\text{ k}\Omega$

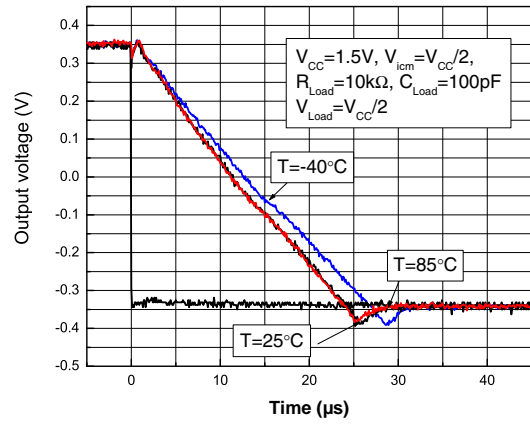

Figure 9. Positive slew rate vs. time, $V_{CC} = 5.5\text{ V}$, $C_{Load} = 100\text{ pF}$, $R_{Load} = 100\text{ k}\Omega$

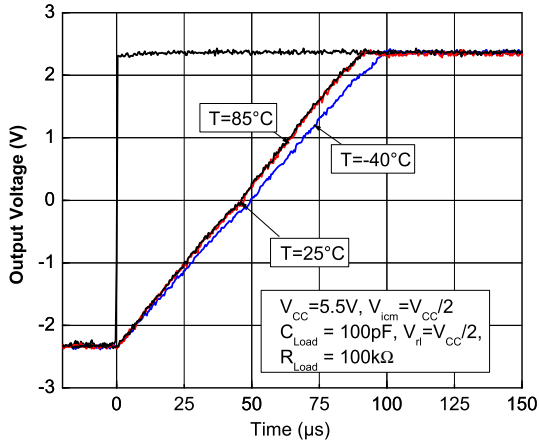

Figure 10. Negative slew rate vs. time, $V_{CC} = 5.5\text{ V}$, $C_{Load} = 100\text{ pF}$, $R_{Load} = 100\text{ k}\Omega$

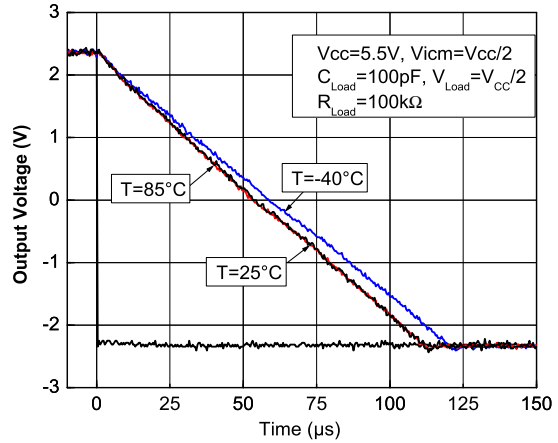

Figure 11. Slew rate vs. supply voltage

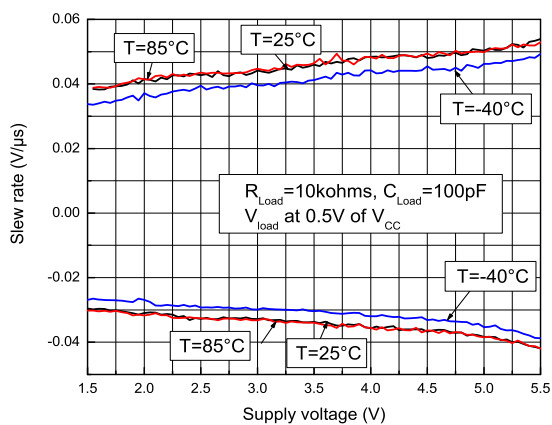

Figure 12. Noise vs. frequency at $V_{CC} = 5\text{ V}$

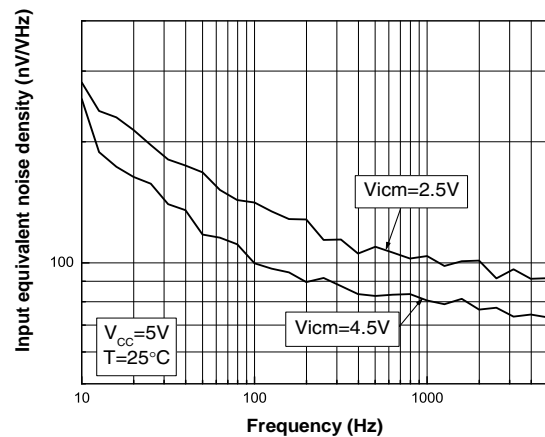

Figure 13. Distortion + noise vs. frequency



Figure 14. Distortion + noise vs. output voltage



Figure 15. Voltage gain and phase vs. frequency at $V_{CC} = 1.8 V$ (based on simulation results)

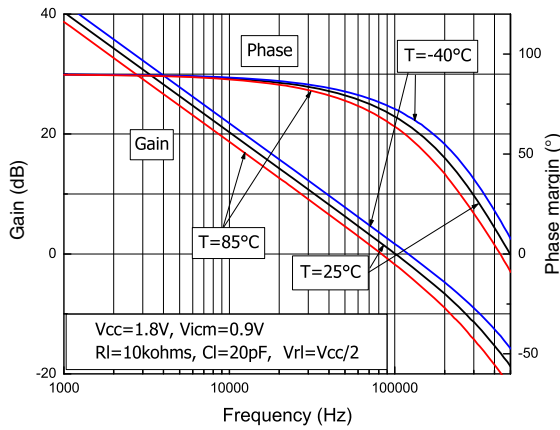

Figure 16. Voltage gain and phase vs. frequency at $V_{CC} = 5 V$ (based on simulation results)



3 Application information

3.1 Operating voltages

The TSV61x can operate from 1.5 to 5.5 V. The parameters are fully specified for 1.8, 3.3, and 5 V power supplies. However, the parameters are very stable in the full V_{CC} range and several characterization curves show the TSV61x characteristics at 1.5 V. Additionally, the main specifications are guaranteed in extended temperature ranges from $-40\text{ }^{\circ}\text{C}$ to $85\text{ }^{\circ}\text{C}$.

3.2 Rail-to-rail input

The TSV61x are built with two complementary PMOS and NMOS input differential pairs. The devices have a rail-to-rail input, and the input common mode range is extended from $(V_{CC-}) - 0.1\text{ V}$ to $(V_{CC+}) + 0.1\text{ V}$. The transition between the two pairs appears at $(V_{CC+}) - 0.7\text{ V}$. In the transition region, the performance of CMRR, PSRR, V_{IO} and THD is slightly degraded (as shown in [Figure 17](#) and [Figure 18](#) for V_{IO} vs. V_{ICM}).

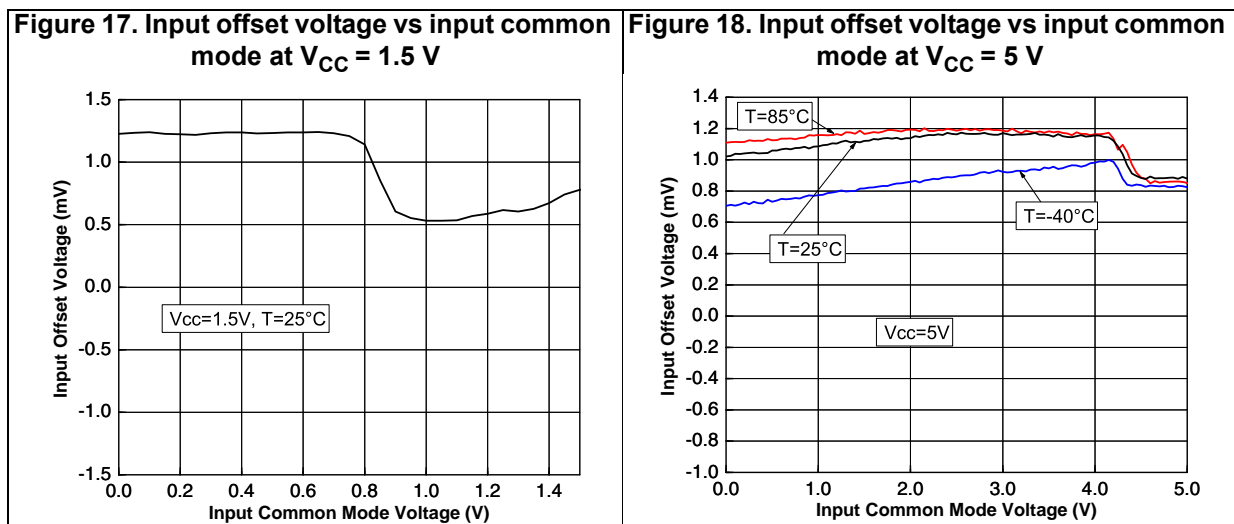

The device is guaranteed without phase reversal.

3.3 Rail-to-rail output

The operational amplifiers' output levels can go close to the rails: less than 35 mV above GND rail and less than 35 mV below V_{CC} rail when connected to $10\text{ k}\Omega$ load to $V_{CC}/2$.

3.4 Driving resistive and capacitive loads

These products are micro-power, low-voltage operational amplifiers optimized to drive rather large resistive loads, above 10 k Ω . For lower resistive loads, the THD level may significantly increase.

In a follower configuration, these operational amplifiers can drive capacitive loads up to 100 pF with no oscillations. When driving larger capacitive loads, adding an in-series resistor at the output can improve the stability of the devices (see [Figure 19](#) for recommended in-series resistor values). Once the in-series resistor value has been selected, the stability of the circuit should be tested on bench and simulated with the simulation model.

Figure 19. In-series resistor vs. capacitive load

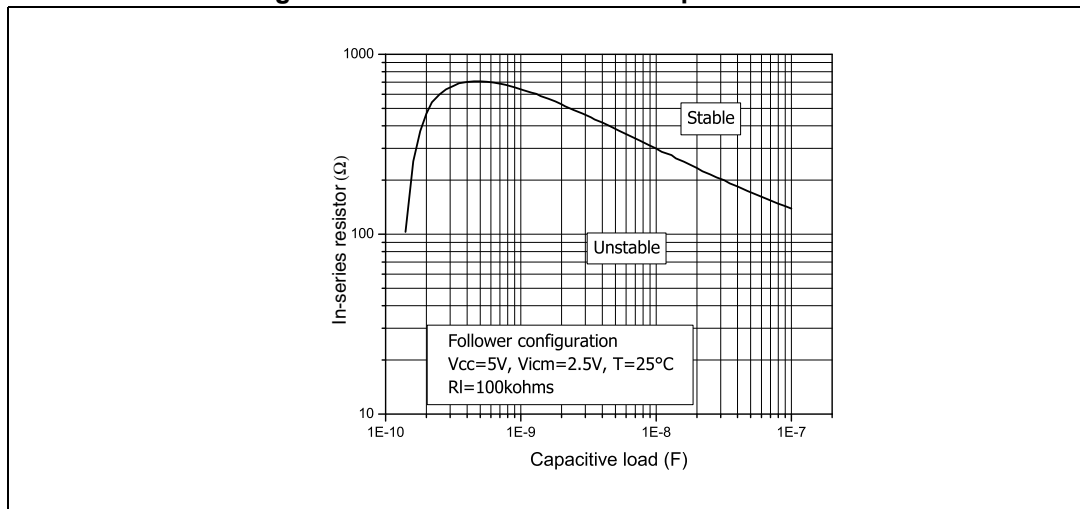

3.5 PCB layouts

For correct operation, it is advised to add 10 nF decoupling capacitors as close as possible to the power supply pins.

3.6 Macromodel

An accurate macromodel of the TSV61x is available on STMicroelectronics' web site at www.st.com. This model is a trade-off between accuracy and complexity (that is, time simulation) of the TSV61x operational amplifiers. It emulates the nominal performances of a typical device within the specified operating conditions mentioned in the datasheet. It also helps to validate a design approach and to select the right operational amplifier, *but it does not replace on-board measurements*.

4 Package information

In order to meet environmental requirements, ST offers these devices in different grades of ECOPACK[®] packages, depending on their level of environmental compliance. ECOPACK[®] specifications, grade definitions and product status are available at: www.st.com. ECOPACK[®] is an ST trademark.

4.1 SOT23-5 package information

Figure 20. SOT23-5 package outline

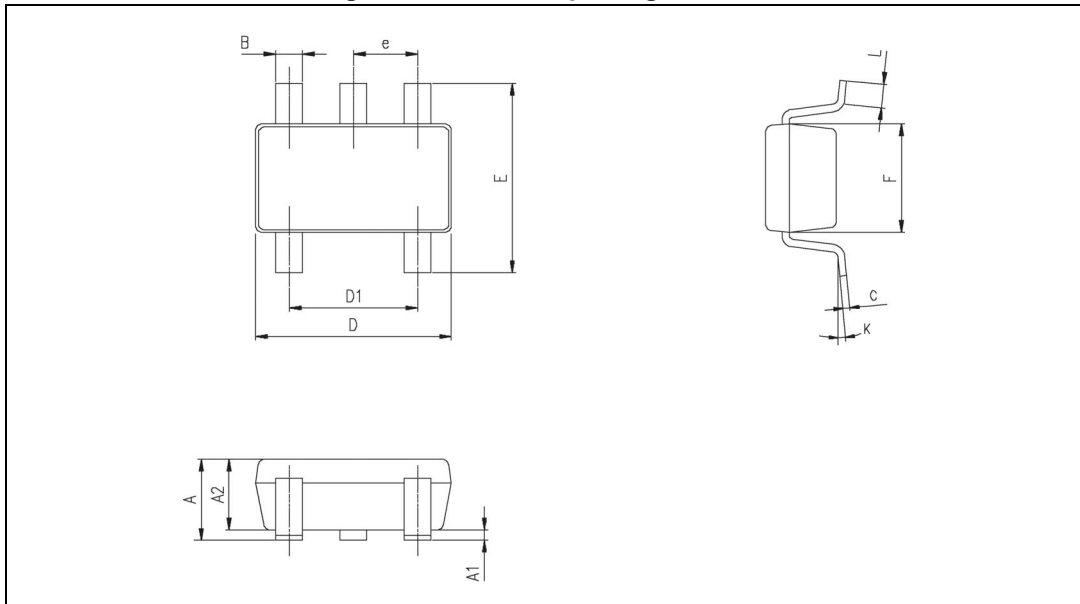

Table 6. SOT23-5 mechanical data

Ref.	Dimensions					
	Millimeters			Inches		
	Min.	Typ.	Max.	Min.	Typ.	Max.
A	0.90	1.20	1.45	0.035	0.047	0.057
A1			0.15			0.006
A2	0.90	1.05	1.30	0.035	0.041	0.051
B	0.35	0.40	0.50	0.013	0.015	0.019
C	0.09	0.15	0.20	0.003	0.006	0.008
D	2.80	2.90	3.00	0.110	0.114	0.118
D1		1.90			0.075	
e		0.95			0.037	
E	2.60	2.80	3.00	0.102	0.110	0.118
F	1.50	1.60	1.75	0.059	0.063	0.069
L	0.10	0.35	0.60	0.004	0.013	0.023
K	0 degrees		10 degrees			

4.2 SC70-5 (SOT323-5) package information

Figure 21. SC70-5 (SOT323-5) package outline



Table 7. SC70-5 (SOT323-5) mechanical data

Ref	Dimensions					
	Millimeters			Inches		
	Min	Typ	Max	Min	Typ	Max
A	0.80		1.10	0.315		0.043
A1			0.10			0.004
A2	0.80	0.90	1.00	0.315	0.035	0.039
b	0.15		0.30	0.006		0.012
c	0.10		0.22	0.004		0.009
D	1.80	2.00	2.20	0.071	0.079	0.087
E	1.80	2.10	2.40	0.071	0.083	0.094
E1	1.15	1.25	1.35	0.045	0.049	0.053
e		0.65			0.025	
e1		1.30			0.051	
L	0.26	0.36	0.46	0.010	0.014	0.018
<	0°		8°			

4.3 SO8 package information

Figure 22. SO8 package outline



Table 8. SO8 mechanical data

Ref.	Dimensions					
	Millimeters			Inches		
	Min.	Typ.	Max.	Min.	Typ.	Max.
A			1.75			0.069
A1	0.10		0.25	0.004		0.010
A2	1.25			0.049		
b	0.28		0.48	0.011		0.019
c	0.17		0.23	0.007		0.010
D	4.80	4.90	5.00	0.189	0.193	0.197
E	5.80	6.00	6.20	0.228	0.236	0.244
E1	3.80	3.90	4.00	0.150	0.154	0.157
e		1.27			0.050	
h	0.25		0.50	0.010		0.020
L	0.40		1.27	0.016		0.050
L1		1.04			0.040	
k	1°		8°	1°		8°
ccc			0.10			0.004

4.4 MiniSO8 package information

Figure 23. MiniSO8 package outline

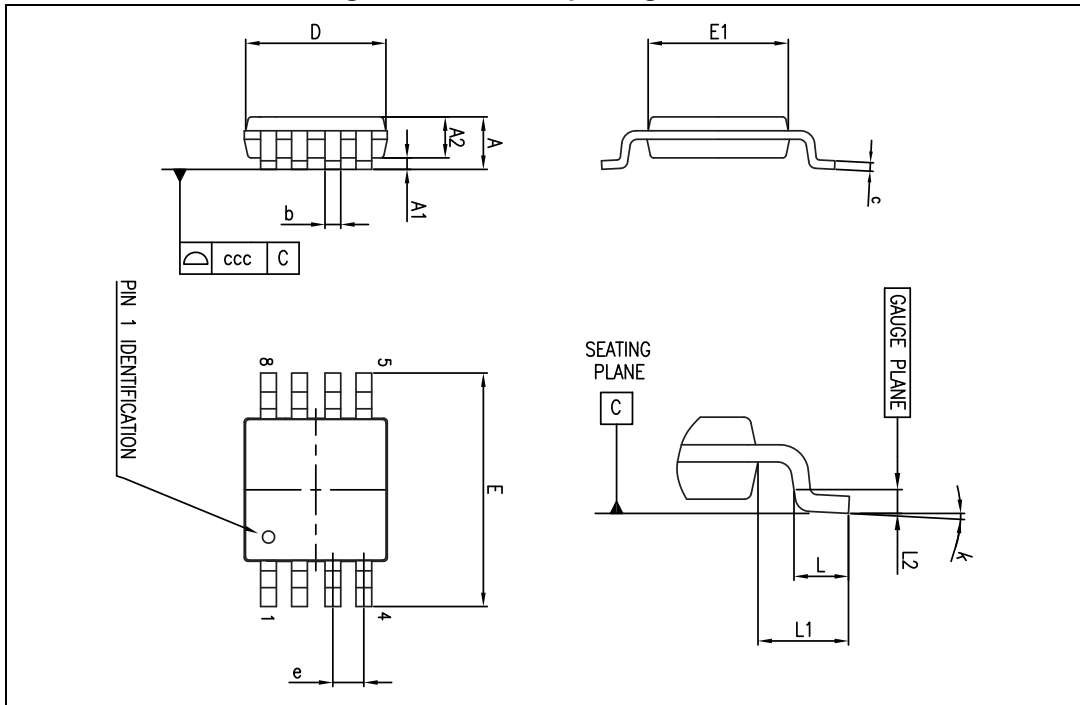

Table 9. MiniSO8 mechanical data

Ref.	Dimensions					
	Millimeters			Inches		
	Min.	Typ.	Max.	Min.	Typ.	Max.
A			1.1			0.043
A1	0		0.15	0		0.006
A2	0.75	0.85	0.95	0.030	0.033	0.037
b	0.22		0.40	0.009		0.016
c	0.08		0.23	0.003		0.009
D	2.80	3.00	3.20	0.11	0.118	0.126
E	4.65	4.90	5.15	0.183	0.193	0.203
E1	2.80	3.00	3.10	0.11	0.118	0.122
e		0.65			0.026	
L	0.40	0.60	0.80	0.016	0.024	0.031
L1		0.95			0.037	
L2		0.25			0.010	
k	0°		8°	0°		8°
ccc			0.10			0.004

5 Ordering information

Table 10. Order codes

Order code	Temperature range	Package	Packing	Marking
TSV611ILT	-40 °C to 85 °C	SOT23-5	Tape and reel	K12
TSV611AILT				K11
TSV611ICT		SC70-5		K12
TSV611AICT				K11
TSV612IDT		SO-8		V612I
TSV612AIDT				V612AI
TSV612IST		MiniSO-8		K113
TSV612AIST				K115

6 Revision history

Table 11. Document revision history

Date	Revision	Changes
28-May-2009	1	Initial release.
18-Jan-2010	2	Full datasheet for product now in production. Added Figure 1 to Figure 19.
11-May-2017	3	<i>Table 3, Table 4, and Table 5</i> : changed “ DV_{io} to $\Delta V_{io}/\Delta T$ ”, updated V_{OH} parameter information, changed min. values of V_{OH} parameter to max. values. <i>Table 10: Order codes</i> : removed obsolete order codes TSV612ID and TSV612AID