

Description

The TSV620, TSV620A, TSV621, and TSV621A are single operational amplifiers offering low voltage, low power operation, and rail-to-rail input and output.

With a very low input bias current and low offset voltage (800 μ V maximum for the A version), the TSV62x is ideal for applications requiring precision. The device can operate at a power supply ranging from 1.5 to 5.5 V, and therefore suit battery-powered devices and extend their battery life.

This product features an excellent speed/power consumption ratio, offering a 420 kHz gain bandwidth while consuming only 29 μ A at a 5 V supply voltage.

These operational amplifiers are unity gain stable for capacitive loads up to 100 pF.

The device is internally adjusted to provide very narrow dispersion of AC and DC parameters, especially power consumption, product gain bandwidth, and slew rate.

The TSV62x present high tolerance to ESD, sustaining 4 kV for the human body model.

The device is offered in macropackages, SC70-6 and SOT23-6 for the TSV620 and SC70-5 and SOT23-5 for the TSV621. They are guaranteed for industrial temperature ranges from -40 °C to 125 °C.

All these features make the TSV620, TSV620A, TSV621, and TSV621A ideal for sensor interfaces, battery-supplied and portable applications, as well as active filtering.

Features

- Low supply voltage: 1.5 V–5.5 V
- Rail-to-rail input and output
- Low input offset voltage: 800 μ V max (A version)
- Low power consumption: 29 μ A typ
- Low power shutdown mode: 5 nA typ (TSV620)
- Gain bandwidth product: 420 kHz typ
- Unity gain stability
- Micropackages: SC70-5/6, SOT23-5/6
- Low input bias current: 1 pA typ
- Extended temperature range: -40 to 125 °C
- 4 kV HBM

Applications

- Battery-powered applications
- Portable device
- Signal conditioning
- Active filtering
- Medical instrumentation

Contents

1	Absolute maximum ratings and operating conditions	3
2	Electrical characteristics	4
3	Application information	12
3.1	Operating voltages	12
3.2	Rail-to-rail input	12
3.3	Rail-to-rail output	12
3.4	Shutdown function (TSV620)	13
3.5	Optimization of DC and AC parameters	14
3.6	Driving resistive and capacitive loads	14
3.7	PCB layouts	14
3.8	Macromodel	15
4	Package information	16
4.1	SOT23-5 package information	17
4.2	SOT23-6 package information	18
4.3	SC70-5 (or SOT323-5) package information	19
4.4	SC70-6 (or SOT323-6) package information	20
5	Ordering information	22
6	Revision history	23

1 Absolute maximum ratings and operating conditions

Table 1. Absolute maximum ratings (AMR)

Symbol	Parameter	Value	Unit
V_{CC}	Supply voltage ⁽¹⁾	6	V
V_{id}	Differential input voltage ⁽²⁾	$\pm V_{CC}$	
V_{in}	Input voltage ⁽³⁾	$(V_{CC-}) - 0.2$ to $(V_{CC+}) + 0.2$	
I_{in}	Input current ⁽⁴⁾	10	mA
\overline{SHDN}	Shutdown voltage ⁽⁵⁾	$(V_{CC-}) - 0.2$ to $(V_{CC+}) + 0.2$	V
T_{stg}	Storage temperature	-65 to 150	°C
R_{thja}	Thermal resistance junction to ambient ^{(6) (7)}		°C/W
	SC70-5	205	
	SOT23-5	250	
	SOT23-6	240	
	SC70-6	232	
T_j	Maximum junction temperature	150	°C
ESD	HBM: human body model ⁽⁸⁾	4	kV
	MM: machine model ⁽⁹⁾	300	V
	CDM: charged device model ⁽¹⁰⁾	1.5	kV
	Latch-up immunity	200	mA

- All voltage values, except differential voltage are with respect to network ground terminal.
- Differential voltages are the non-inverting input terminal with respect to the inverting input terminal.
- V_{CC} - V_{in} must not exceed 6 V.
- Input current must be limited by a resistor in series with the inputs.
- V_{CC} - \overline{SHDN} must not exceed 6 V.
- Short-circuits can cause excessive heating and destructive dissipation.
- R_{th} are typical values.
- Human body model: 100 pF discharged through a 1.5 k Ω resistor between two pins of the device, done for all couples of pin combinations with other pins floating.
- Machine mode: a 200 pF capacitor is charged to the specified voltage, then discharged directly between two pins of the device with no external series resistor (internal resistor < 5 Ω), done for all couples of pin combinations with other pins floating.
- Charged device model: all pins plus package are charged together to the specified voltage and then discharged directly to the ground.

Table 2. Operating conditions

Symbol	Parameter	Value	Unit
V_{CC}	Supply voltage	1.5 to 5.5	V
V_{icm}	Common mode input voltage range	$(V_{CC-}) - 0.1$ to $(V_{CC+}) + 0.1$	
T_{oper}	Operating free air temperature range	-40 to +125	°C

2 Electrical characteristics

Table 3. Electrical characteristics at $V_{CC+} = 1.8\text{ V}$ with $V_{DD} = 0\text{ V}$, $V_{icm} = V_{CC}/2$, $T_{op} = 25\text{ }^{\circ}\text{C}$, and R_L connected to $V_{CC}/2$ (unless otherwise specified)

Symbol	Parameter	Conditions	Min.	Typ.	Max.	Unit
DC performance						
V_{io}	Offset voltage	TSV62x TSV62xA			4 0.8	mV
		$T_{min} < T_{op} < T_{max}$ TSV62x TSV62xA			6 2.8	
$\Delta V_{io}/\Delta T$	Input offset voltage drift			2		$\mu\text{V}/^{\circ}\text{C}$
I_{io}	Input offset current ($V_{out} = V_{CC}/2$)			1	10 ⁽¹⁾	pA
		$T_{min} < T_{op} < T_{max}$		1	100	
I_{ib}	Input bias current ($V_{out} = V_{CC}/2$)			1	10 ⁽¹⁾	pA
		$T_{min} < T_{op} < T_{max}$		1	100	
CMR	Common mode rejection ratio $20 \log (\Delta V_{ic}/\Delta V_{io})$	0 V to 1.8 V, $V_{out} = 0.9\text{ V}$	53	74		dB
		$T_{min} < T_{op} < T_{max}$	51			
A_{vd}	Large signal voltage gain	$R_L = 10\text{ k}\Omega$, $V_{out} = 0.5\text{ V to }1.3\text{ V}$	78	95		dB
		$T_{min} < T_{op} < T_{max}$	73			
V_{OH}	High level output voltage ($V_{OH} = V_{CC} - V_{out}$)	$R_L = 10\text{ k}\Omega$		5	35	mV
		$T_{min} < T_{op} < T_{max}$			50	
V_{OL}	Low level output voltage	$R_L = 10\text{ k}\Omega$		4	35	mV
		$T_{min} < T_{op} < T_{max}$			50	
I_{out}	Isink	$V_o = 1.8\text{ V}$	6	12		mA
		$T_{min} < T_{op} < T_{max}$	4			
	Isource	$V_o = 0\text{ V}$	6	10		
		$T_{min} < T_{op} < T_{max}$	4			
I_{CC}	Supply current (per operator)	No load, $V_{out} = V_{CC}/2$		25	31	μA
		$T_{min} < T_{op} < T_{max}$			33	
AC performance						
GBP	Gain bandwidth product	$R_L = 10\text{ k}\Omega$, $C_L = 100\text{ pF}$, $f = 100\text{ kHz}$	275	340		kHz
F_u	Unity gain frequency			280		
ϕ_m	Phase margin	$R_L = 10\text{ k}\Omega$, $C_L = 100\text{ pF}$		45		Degrees
G_m	Gain margin			9		dB
SR	Slew rate	$R_L = 10\text{ k}\Omega$, $C_L = 100\text{ pF}$, $A_v = 1$	0.084	0.11	0.14	$\text{V}/\mu\text{s}$

1. Guaranteed by design.

Table 4. Shutdown characteristics $V_{CC} = 1.8\text{ V}$

Symbol	Parameter	Conditions	Min.	Typ.	Max.	Unit
DC performance						
I_{CC}	Supply current in shutdown mode (all operators)	$\overline{\text{SHDN}} = V_{CC-}$		2.5	50	nA
		$T_{\text{min}} < T_{\text{op}} < 85^\circ\text{ C}$			200	
		$T_{\text{min}} < T_{\text{op}} < 125^\circ\text{ C}$			1.5	μA
t_{on}	Amplifier turn-on time	$R_L = 2\text{ k}\Omega$ $V_{\text{out}} = (V_{CC-}) \text{ to } V_{CC} + 0.2$		300		ns
t_{off}	Amplifier turn-off time	$R_L = 2\text{ k}\Omega$ $V_{\text{out}} = (V_{CC+}) - 0.5 \text{ to } (V_{CC+}) + 0.7$		30		
V_{IH}	$\overline{\text{SHDN}}$ logic high		1.3			V
V_{IL}	$\overline{\text{SHDN}}$ logic low				0.5	
I_{IH}	$\overline{\text{SHDN}}$ current high	$\overline{\text{SHDN}} = V_{CC+}$		10		pA
I_{IL}	$\overline{\text{SHDN}}$ current low	$\overline{\text{SHDN}} = V_{CC-}$		10		
I_{OLeak}	Output leakage in shutdown mode	$\overline{\text{SHDN}} = V_{CC-}$		50		
		$T_{\text{min}} < T_{\text{op}} < 125^\circ\text{ C}$		1		nA

Table 5. $V_{CC+} = 3.3\text{ V}$, $V_{CC-} = 0\text{ V}$, $V_{icm} = V_{CC}/2$, $T_{op} = 25^\circ\text{ C}$, R_L connected to $V_{CC}/2$
(unless otherwise specified)

Symbol	Parameter	Conditions	Min.	Typ.	Max.	Unit
DC performance						
V_{io}	Offset voltage	TSV62x TSV62xA			4 0.8	mV
		$T_{min} < T_{op} < T_{max}$ TSV62x TSV62xA			6 2.8	
$\Delta V_{io}/\Delta T$	Input offset voltage drift			2		$\mu\text{V}/^\circ\text{C}$
I_{io}	Input offset current			1	$10^{(1)}$	pA
		$T_{min} < T_{op} < T_{max}$		1	100	
I_{ib}	Input bias current			1	$10^{(1)}$	pA
		$T_{min} < T_{op} < T_{max}$		1	100	
CMR	Common mode rejection ratio $20 \log (\Delta V_{ic}/\Delta V_{io})$	0 V to 3.3 V, $V_{out} = 1.75\text{ V}$	57	79		dB
		$T_{min} < T_{op} < T_{max}$	53			
A_{vd}	Large signal voltage gain	$R_L = 10\text{ k}\Omega$, $V_{out} = 0.5\text{ V to } 2.8\text{ V}$	81	98		dB
		$T_{min} < T_{op} < T_{max}$	76			
V_{OH}	High level output voltage ($V_{OH} = V_{CC} - V_{out}$)	$R_L = 10\text{ k}\Omega$		5	35	mV
		$T_{min} < T_{op} < T_{max}$			50	
V_{OL}	Low level output voltage	$R_L = 10\text{ k}\Omega$		4	35	mV
		$T_{min} < T_{op} < T_{max}$			50	
I_{out}	Isink	$V_o = 5\text{ V}$	30	45		mA
		$T_{min} < T_{op} < T_{max}$	25			
	Isource	$V_o = 0\text{ V}$	30	38		
		$T_{min} < T_{op} < T_{max}$	25			
I_{CC}	Supply current (per operator)	No load, $V_{out} = 2.5\text{ V}$		26	33	μA
		$T_{min} < T_{op} < T_{max}$			35	
AC performance						
GBP	Gain bandwidth product	$R_L = 10\text{ k}\Omega$, $C_L = 100\text{ pF}$, $f = 100\text{ kHz}$	310	380		kHz
F_u	Unity gain frequency			310		
ϕ_m	Phase margin	$R_L = 10\text{ k}\Omega$, $C_L = 100\text{ pF}$		45		Degrees
G_m	Gain margin			9		dB
SR	Slew rate	$R_L = 10\text{ k}\Omega$, $C_L = 100\text{ pF}$, $A_V = 1$	0.094	0.12		V/ μs

1. Guaranteed by design.

**Table 6. $V_{CC+} = 5\text{ V}$, $V_{CC-} = 0\text{ V}$, $V_{icm} = V_{CC}/2$, $T_{op} = 25^\circ\text{ C}$, R_L connected to $V_{CC}/2$
(unless otherwise specified)**

Symbol	Parameter		Min.	Typ.	Max.	Unit
DC performance						
V_{io}	Offset voltage	TSV62x			4	mV
		TSV62xA			0.8	
		$T_{min} < T_{op} < T_{max}$			6	
		TSV62x			2.8	
		TSV62xA				
$\Delta V_{io}/\Delta T$	Input offset voltage drift			2		$\mu\text{V}/^\circ\text{C}$
I_{io}	Input offset current			1	$10^{(1)}$	pA
		$T_{min} < T_{op} < T_{max}$		1	100	
I_{ib}	Input bias current			1	$10^{(1)}$	pA
		$T_{min} < T_{op} < T_{max}$		1	100	
CMR	Common mode rejection ratio $20 \log (\Delta V_{ic}/\Delta V_{io})$	0 V to 5 V, $V_{out} = 2.5\text{ V}$	60	80		dB
		$T_{min} < T_{op} < T_{max}$	55			
SVR	Supply voltage rejection ratio $20 \log (\Delta V_{CC}/\Delta V_{io})$	$V_{CC} = 1.8\text{ to }5\text{ V}$	75	102		dB
		$T_{min} < T_{op} < T_{max}$	73			
A_{vd}	Large signal voltage gain	$R_L = 10\text{ k}\Omega$, $V_{out} = 0.5\text{ V to }4.5\text{ V}$	85	98		
		$T_{min} < T_{op} < T_{max}$	80			
V_{OH}	High level output voltage ($V_{OH} = V_{CC} - V_{out}$)	$R_L = 10\text{ k}\Omega$		7	35	mV
		$T_{min} < T_{op} < T_{max}$			50	
V_{OL}	Low level output voltage	$R_L = 10\text{ k}\Omega$		6	35	mV
		$T_{min} < T_{op} < T_{max}$			50	
I_{out}	I_{sink}	$V_o = 5\text{ V}$	40	69		mA
		$T_{min} < T_{op} < T_{max}$	35	65		
	I_{source}	$V_o = 0\text{ V}$	40	74		
		$T_{min} < T_{op} < T_{max}$	35	68		
I_{CC}	Supply current (per operator)	No load, $V_{out} = 2.5\text{ V}$		29	36	μA
		$T_{min} < T_{op} < T_{max}$			38	
AC performance						
GBP	Gain bandwidth product	$R_L = 10\text{ k}\Omega$, $C_L = 100\text{ pF}$, $f = 100\text{ kHz}$	350	420		kHz
F_u	Unity gain frequency			360		
ϕ_m	Phase margin	$R_L = 10\text{ k}\Omega$, $C_L = 100\text{ pF}$		45		Degrees
G_m	Gain margin			9		dB
SR	Slew rate	$R_L = 10\text{ k}\Omega$, $C_L = 100\text{ pF}$, $A_v = 1$	0.108	0.14		$\text{V}/\mu\text{s}$

Table 6. $V_{CC+} = 5\text{ V}$, $V_{CC-} = 0\text{ V}$, $V_{icm} = V_{CC}/2$, $T_{op} = 25^\circ\text{ C}$, R_L connected to $V_{CC}/2$ (unless otherwise specified) (continued)

Symbol	Parameter		Min.	Typ.	Max.	Unit
e_n	Equivalent input noise voltage	$f = 1\text{ kHz}$		70		$\frac{nV}{\sqrt{Hz}}$
THD	Total harmonic distortion	$A_v = 1$, $f = 1\text{ kHz}$, $R_L = 100\text{ k}\Omega$, $V_{icm} = V_{CC}/2$, $V_{out} = 2 V_{pp}$		0.004		%

1. Guaranteed by design.

Table 7. Shutdown characteristics $V_{CC} = 5\text{ V}$

Symbol	Parameter	Conditions	Min.	Typ.	Max.	Unit
DC performance						
I_{CC}	Supply current in shutdown mode (all operators)	$\overline{\text{SHDN}} = V_{CC-}$		5	50	nA
		$T_{min} < T_{op} < 85^\circ\text{ C}$			200	
		$T_{min} < T_{op} < 125^\circ\text{ C}$				1.5
t_{on}	Amplifier turn-on time	$R_L = 2\text{ k}\Omega$, $V_{out} = (V_{CC-}) + 0.2$		300		ns
t_{off}	Amplifier turn-off time	$R_L = 2\text{ k}\Omega$, $V_{out} = (V_{CC+}) - 0.5$ to $(V_{CC+}) + 0.7$		30		
V_{IH}	$\overline{\text{SHDN}}$ logic high		4.5			V
V_{IL}	$\overline{\text{SHDN}}$ logic low				0.5	
I_{IH}	$\overline{\text{SHDN}}$ current high	$\overline{\text{SHDN}} = V_{CC+}$		10		pA
I_{IL}	$\overline{\text{SHDN}}$ current low	$\overline{\text{SHDN}} = V_{CC-}$		10		
I_{OLeak}	Output leakage in shutdown mode	$\overline{\text{SHDN}} = V_{CC-}$		50		
		$T_{min} < T_{op} < 125^\circ\text{ C}$		1		nA

Figure 1. Input offset voltage vs input common mode at $V_{CC+} = 1.5\text{ V}$

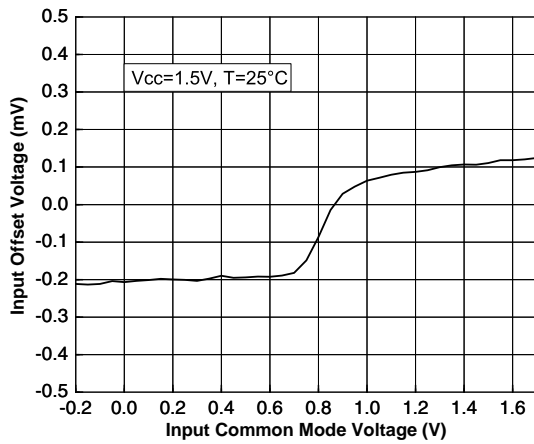

Figure 2. Input offset voltage vs input common mode at $V_{CC+} = 5\text{ V}$

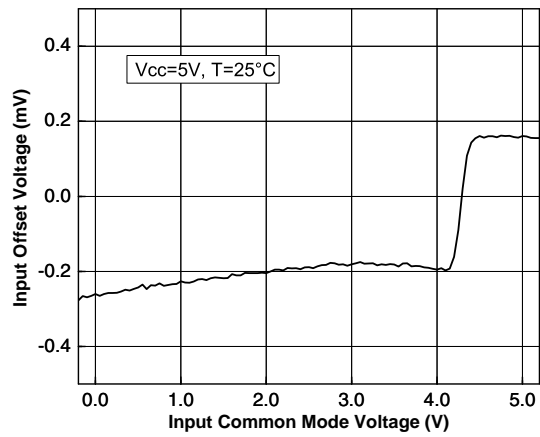

Figure 3. Supply current vs. supply voltage at $V_{icm} = V_{CC}/2$

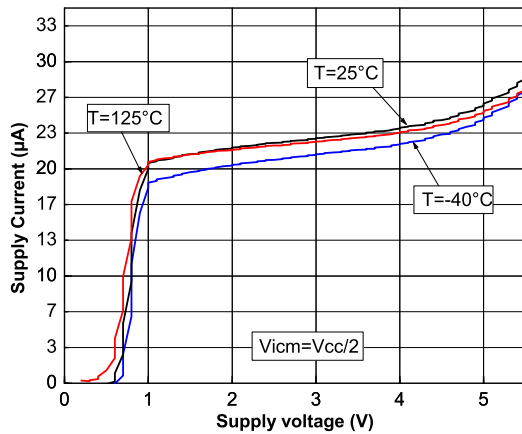

Figure 4. Output current vs. output voltage at $V_{CC+} = 1.5\text{ V}$

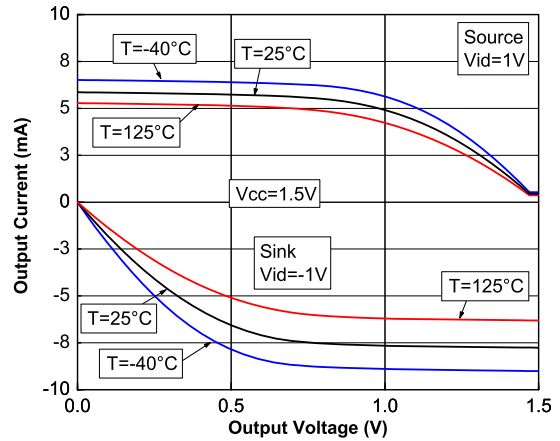

Figure 5. Output current vs. output voltage at $V_{CC+} = 5\text{ V}$

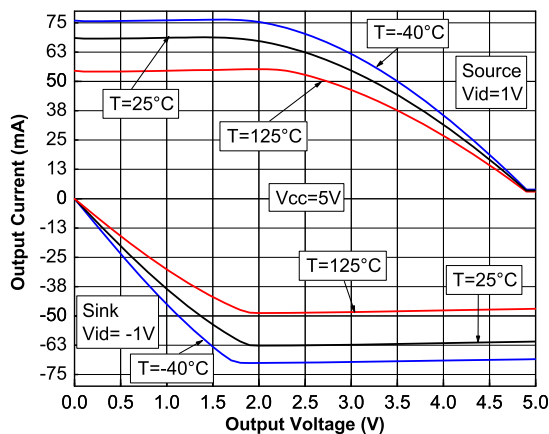

Figure 6. Voltage gain and phase vs. frequency at $V_{CC+} = 1.5\text{ V}$

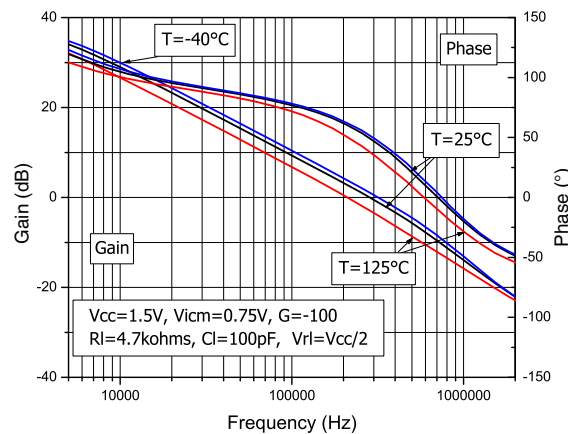

Figure 7. Voltage gain and phase vs. frequency at $V_{CC+} = 5\text{ V}$

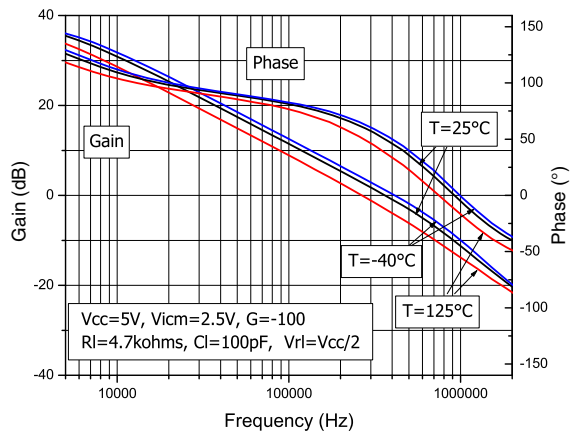

Figure 8. Phase margin vs. output current at $V_{CC+} = 1.5\text{ V}$ and $V_{CC+} = 5\text{ V}$

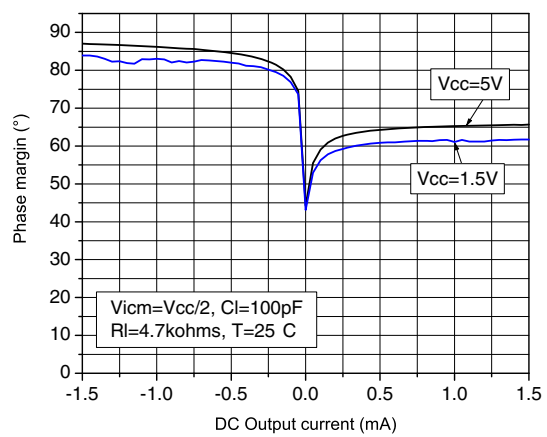

Figure 9. Slew rate vs. supply voltage

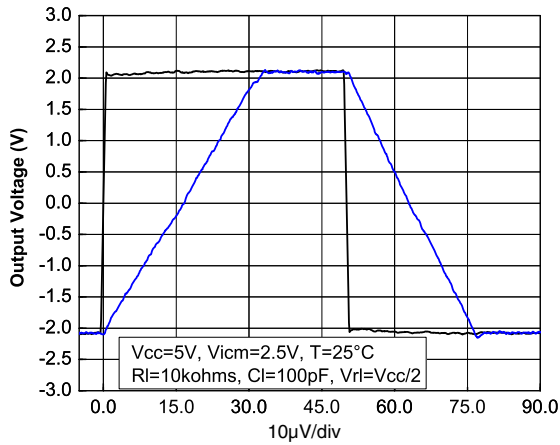

Figure 10. Slew rate vs. supply voltage

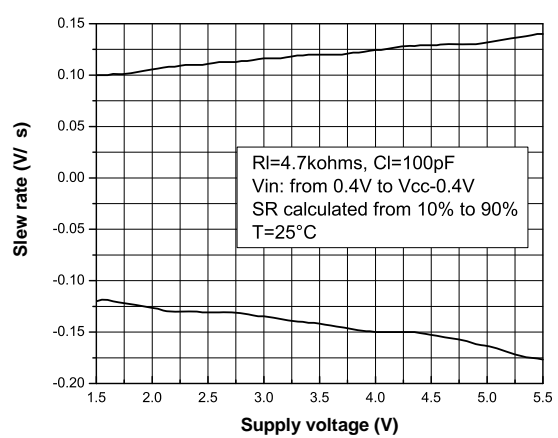

Figure 11. Distortion + noise vs. output voltage

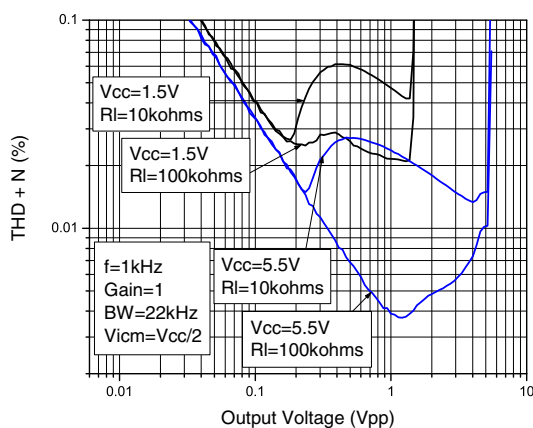
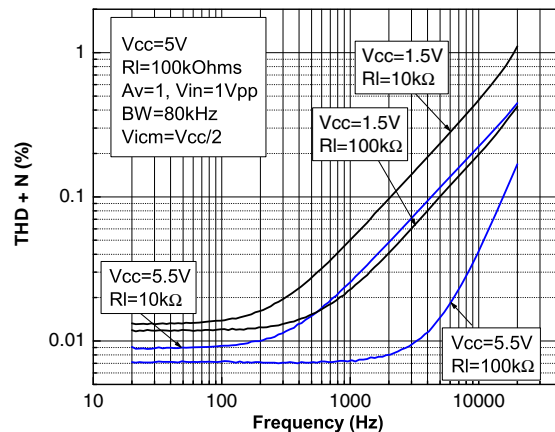
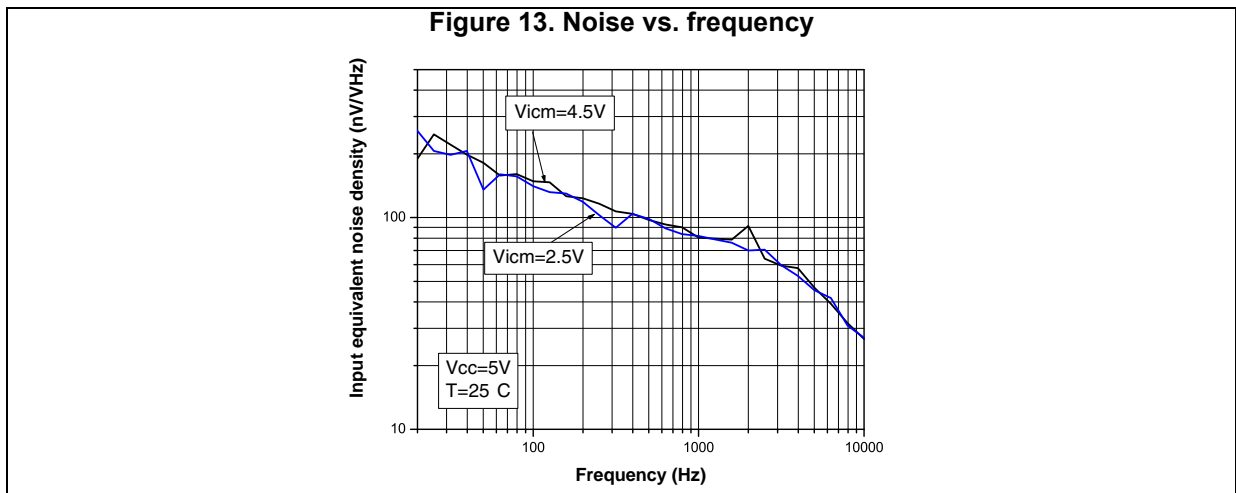

Figure 12. Distortion + noise vs. frequency





3 Application information

3.1 Operating voltages

The TSV620, TSV620A, TSV621, and TSV621A can operate from 1.5 to 5.5 V. Their parameters are fully specified for 1.8, 3.3, and 5 V power supplies. However, the parameters are very stable in the full V_{CC} range and several characterization curves show the TSV62x characteristics at 1.5 V. Additionally, the main specifications are guaranteed in extended temperature ranges from $-40\text{ }^{\circ}\text{C}$ to $125\text{ }^{\circ}\text{C}$.

3.2 Rail-to-rail input

The TSV62x is built with two complementary PMOS and NMOS input differential pairs. The device has a rail-to-rail input and the input common mode range is extended from $(V_{CC-}) - 0.1\text{ V}$ to $(V_{CC+}) + 0.1\text{ V}$. The transition between the two pairs appears at $V_{CC} - 0.7\text{ V}$. In the transition region, the performances of CMRR, PSRR, V_{io} and THD are slightly degraded (as shown in [Figure 14](#) and [Figure 15](#) for V_{io} vs. V_{icm}).

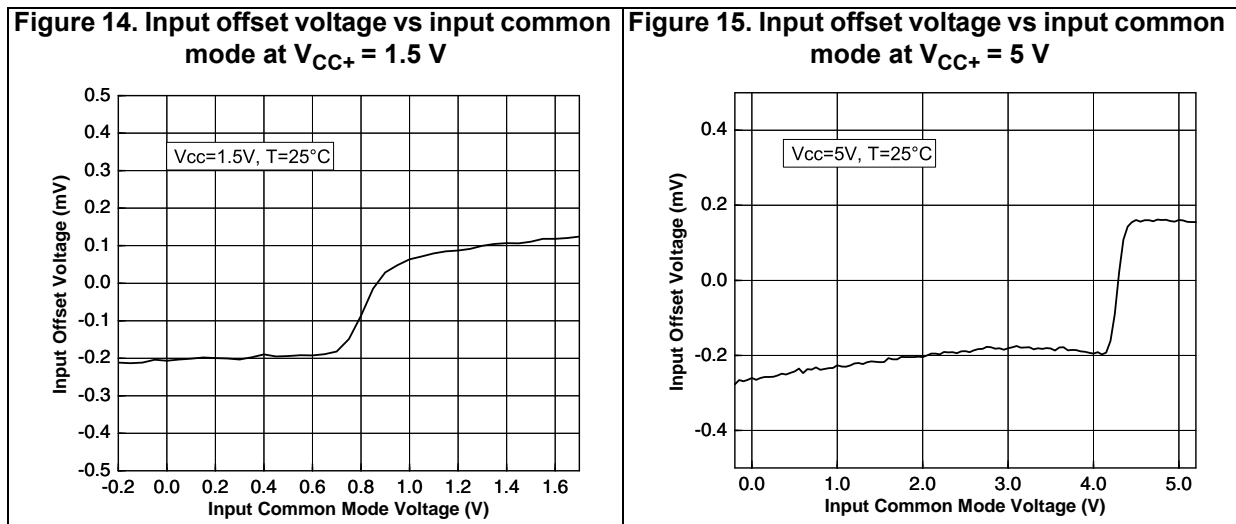

The device is guaranteed without phase reversal.

3.3 Rail-to-rail output

The operational amplifier's output level can go close to the rails: 35 mV maximum above and below the rail when connected to a $10\text{ k}\Omega$ resistive load to $V_{CC}/2$.

3.4 Shutdown function (TSV620)

The operational amplifier is enabled when the $\overline{\text{SHDN}}$ pin is pulled high. To disable the amplifier, the $\overline{\text{SHDN}}$ pin must be pulled down to V_{CC-} . When in shutdown mode, the amplifier output is in a high impedance state. The $\overline{\text{SHDN}}$ pin must never be left floating but tied to V_{CC+} or V_{CC-} .

The turn-on and turn-off times are calculated for an output variation of ± 200 mV (Figure 16 and Figure 17 show the test configurations).

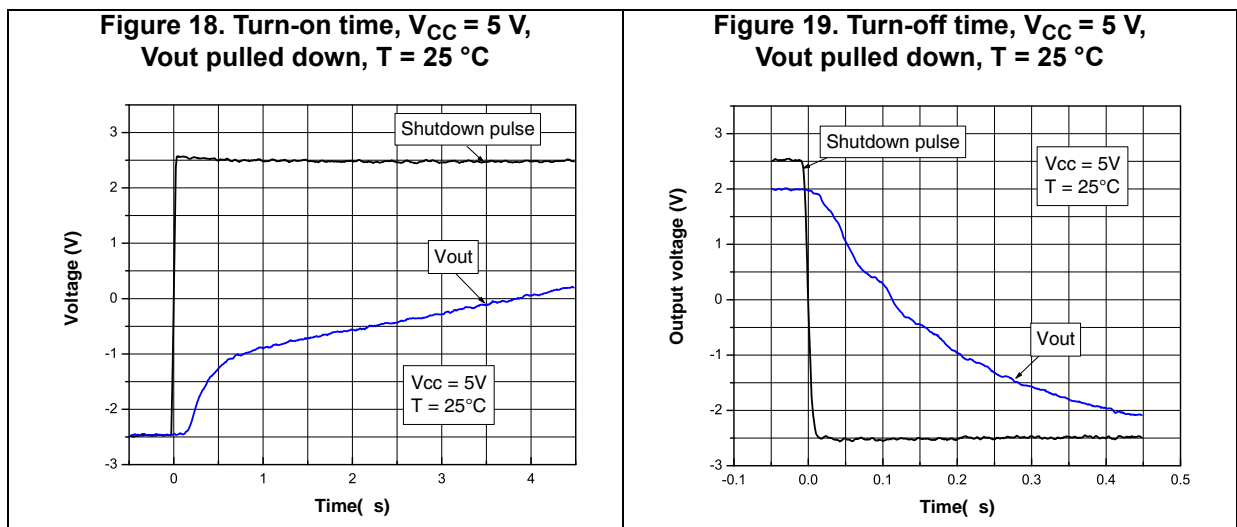
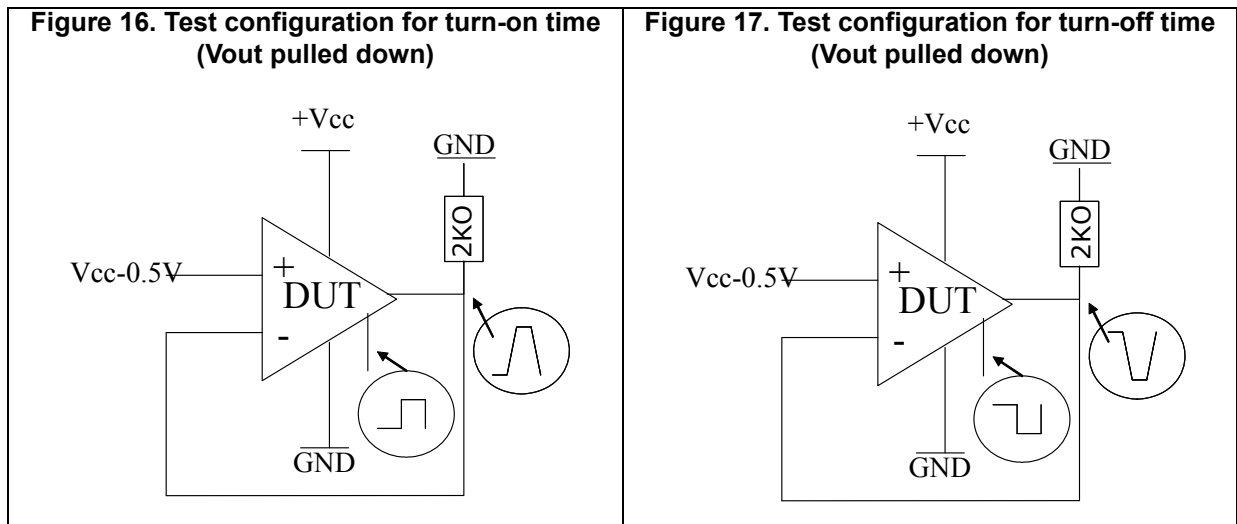

3.5 Optimization of DC and AC parameters

This device uses an innovative approach to reduce the spread of the main DC and AC parameters. An internal adjustment achieves a very narrow spread of current consumption (29 μA typical, min/max at $\pm 17\%$). Parameters linked to the current consumption value, such as GBP, SR and AVd benefit from this narrow dispersion. All parts present a similar speed and the same behavior in terms of stability. In addition, the minimum values of GBP and SR are guaranteed (GBP = 350 kHz min, SR = 0.15 V/ μs min).

3.6 Driving resistive and capacitive loads

These products are micro-power, low-voltage operational amplifiers optimized to drive rather large resistive loads, above 5 k Ω . For lower resistive loads, the THD level may significantly increase.

In a *follower* configuration, these operational amplifiers can drive capacitive loads up to 100 pF with no oscillations. When driving larger capacitive loads, adding a small in-series resistor at the output can improve the stability of the device (see [Figure 20](#) for recommended in-series resistor values). Once the in-series resistor value has been selected, the stability of the circuit should be tested on bench and simulated with the simulation model.

Figure 20. In-series resistor vs. capacitive load

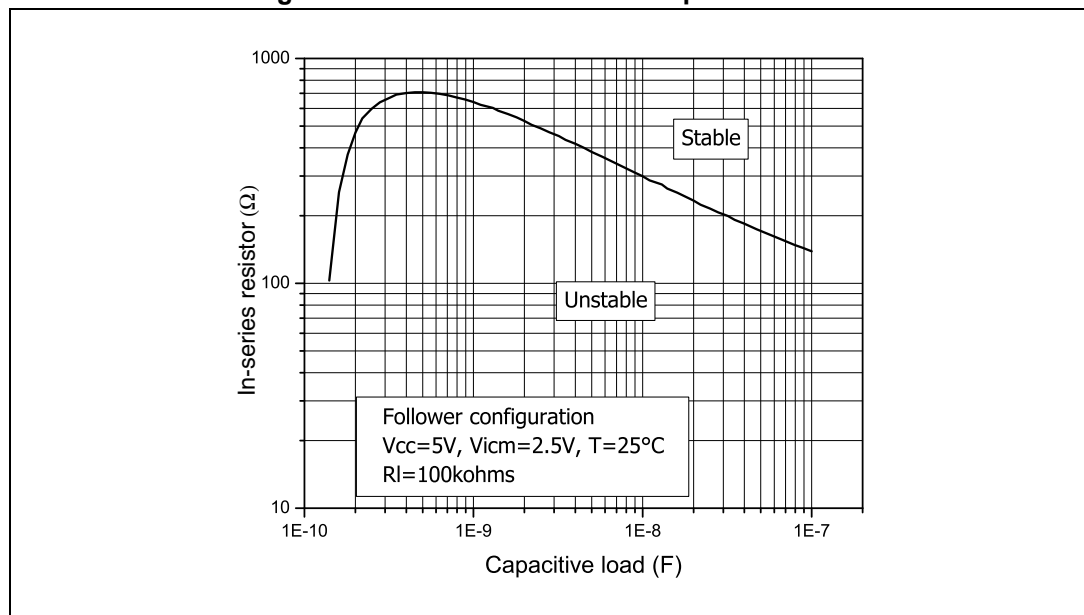

3.7 PCB layouts

For correct operation, it is advised to add 10 nF decoupling capacitors as close as possible to the power supply pins.

3.8 Macromodel

An accurate macromodel of the TSV620, TSV620A, TSV621, and TSV621A is available on STMicroelectronics' web site at www.st.com. This model is a trade-off between accuracy and complexity (that is, time simulation) of the TSV62x operational amplifiers. It emulates the nominal performances of a typical device within the specified operating conditions mentioned in the datasheet. It helps to validate a design approach and to select the right operational amplifier, *but it does not replace on-board measurements*.

4 Package information

In order to meet environmental requirements, ST offers these devices in different grades of ECOPACK[®] packages, depending on their level of environmental compliance. ECOPACK[®] specifications, grade definitions and product status are available at: www.st.com. ECOPACK[®] is an ST trademark.

4.1 SOT23-5 package information

Figure 21. SOT23-5 package outline

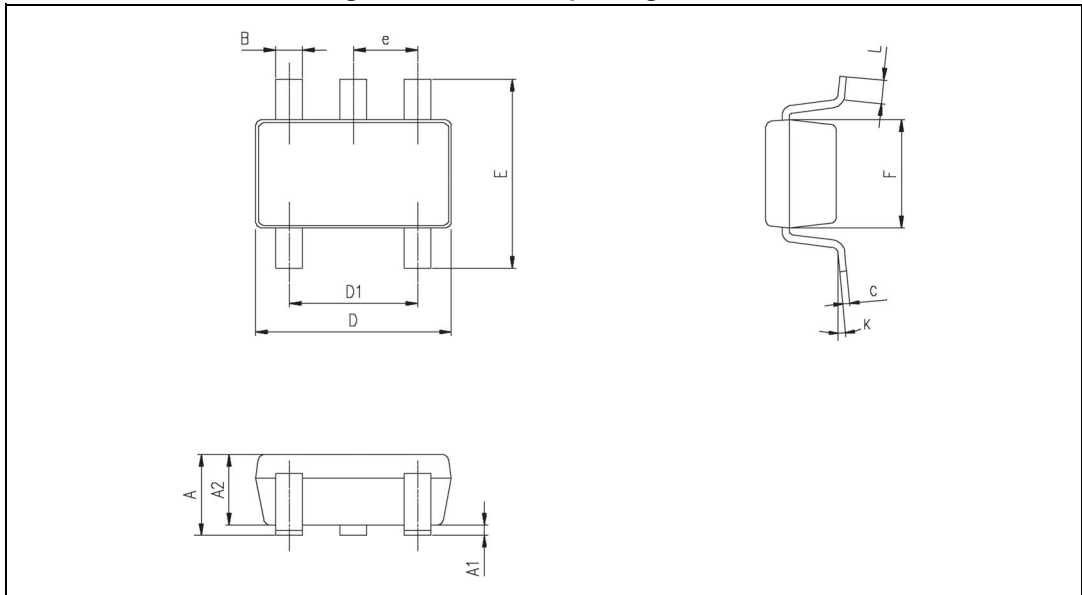

Table 8. SOT23-5 mechanical data

Ref.	Dimensions					
	Millimeters			Inches		
	Min.	Typ.	Max.	Min.	Typ.	Max.
A	0.90	1.20	1.45	0.035	0.047	0.057
A1			0.15			0.006
A2	0.90	1.05	1.30	0.035	0.041	0.051
B	0.35	0.40	0.50	0.013	0.015	0.019
C	0.09	0.15	0.20	0.003	0.006	0.008
D	2.80	2.90	3.00	0.110	0.114	0.118
D1		1.90			0.075	
e		0.95			0.037	
E	2.60	2.80	3.00	0.102	0.110	0.118
F	1.50	1.60	1.75	0.059	0.063	0.069
L	0.10	0.35	0.60	0.004	0.013	0.023
K	0°		10°			

4.2 SOT23-6 package information

Figure 22. SOT23-6 package outline

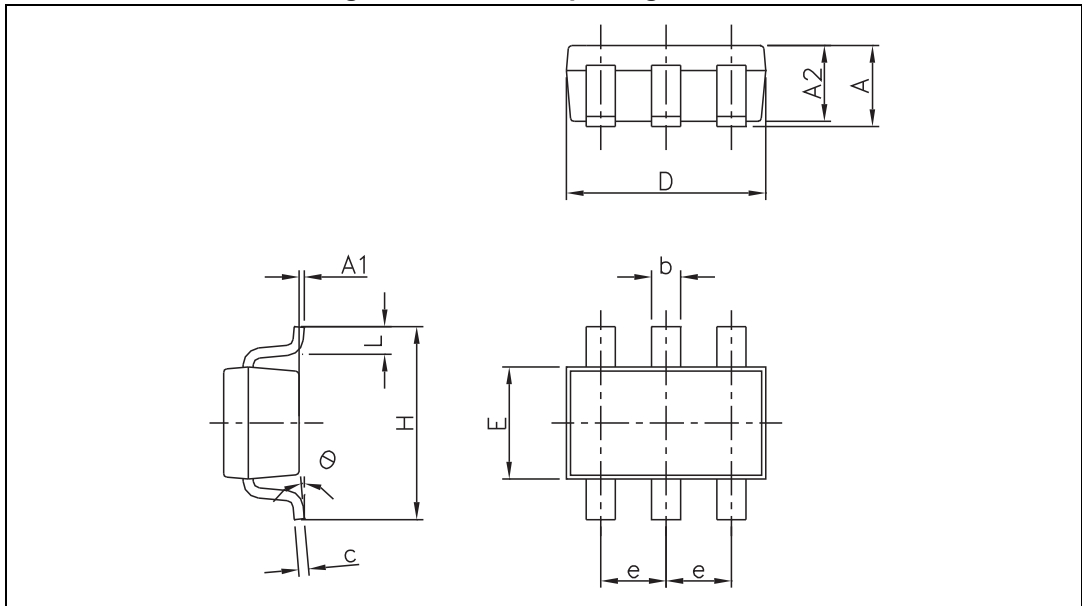

Table 9. SOT23-6 mechanical data

Ref.	Dimensions					
	Millimeters			Inches		
	Min.	Typ.	Max.	Min.	Typ.	Max.
A	0.90		1.45	0.035		0.057
A1			0.10			0.004
A2	0.90		1.30	0.035		0.051
b	0.35		0.50	0.013		0.019
c	0.09		0.20	0.003		0.008
D	2.80		3.05	0.110		0.120
E	1.50		1.75	0.060		0.069
e		0.95			0.037	
H	2.60		3.00	0.102		0.118
L	0.10		0.60	0.004		0.024
°	0		10°			

4.3 SC70-5 (or SOT323-5) package information

Figure 23. SC70-5 (or SOT323-5) package outline

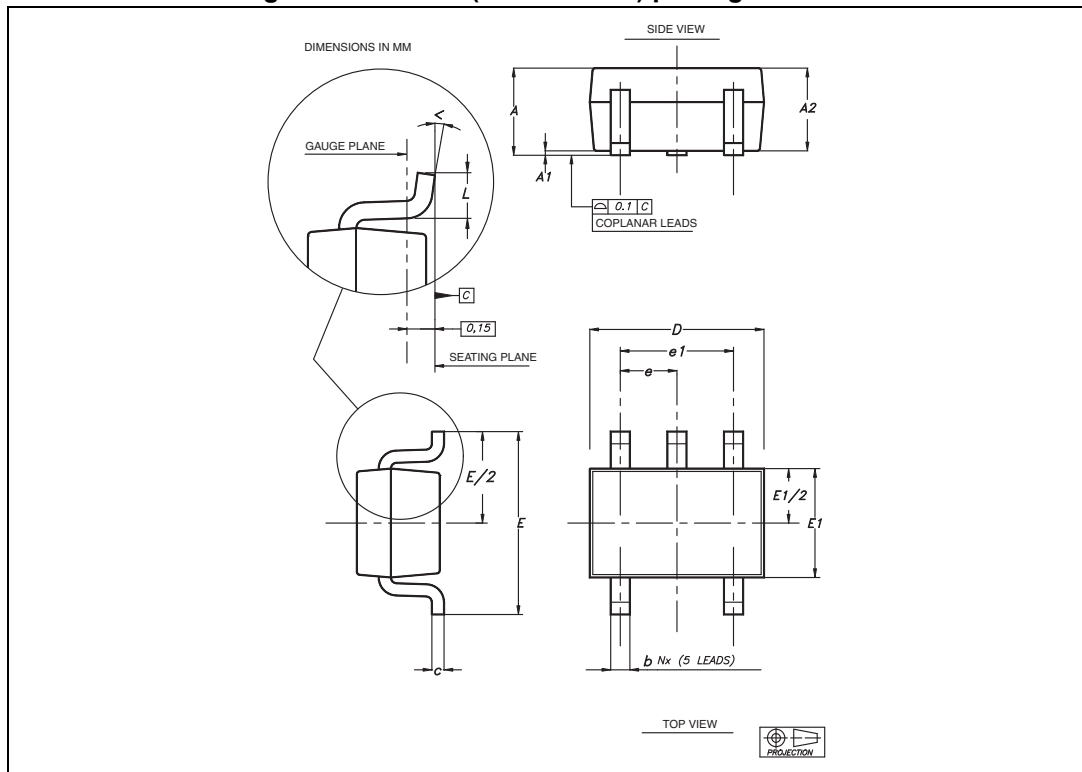

Table 10. SC70-5 (or SOT323-5) mechanical data

Ref	Dimensions					
	Millimeters			Inches		
	Min	Typ	Max	Min	Typ	Max
A	0.80		1.10	0.315		0.043
A1			0.10			0.004
A2	0.80	0.90	1.00	0.315	0.035	0.039
b	0.15		0.30	0.006		0.012
c	0.10		0.22	0.004		0.009
D	1.80	2.00	2.20	0.071	0.079	0.087
E	1.80	2.10	2.40	0.071	0.083	0.094
E1	1.15	1.25	1.35	0.045	0.049	0.053
e		0.65			0.025	
e1		1.30			0.051	
L	0.26	0.36	0.46	0.010	0.014	0.018
<	0°		8°			

4.4 SC70-6 (or SOT323-6) package information

Figure 24. SC70-6 (or SOT323-6) package outline

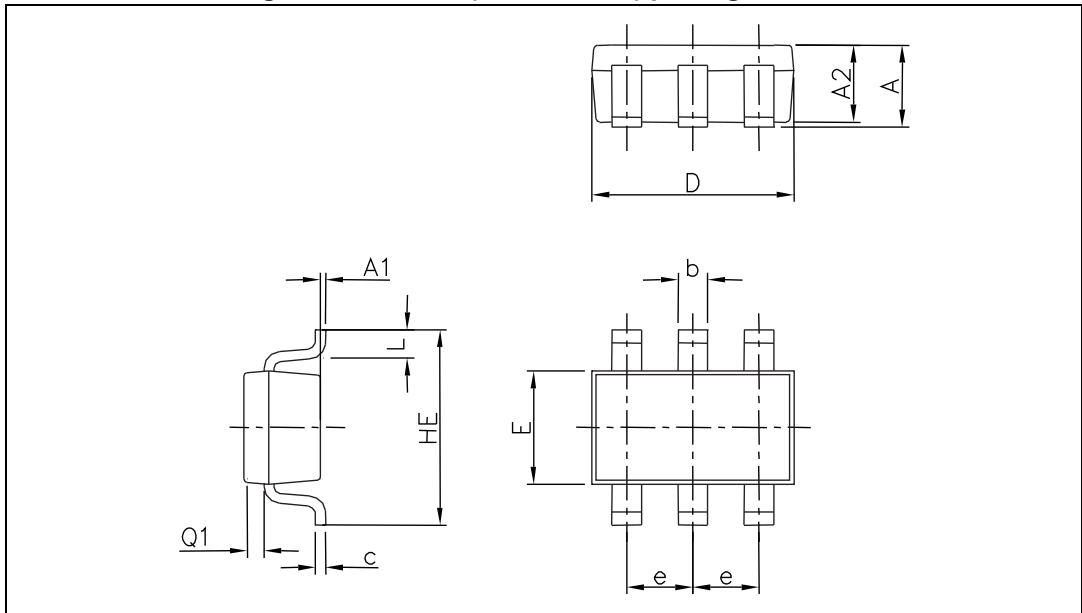
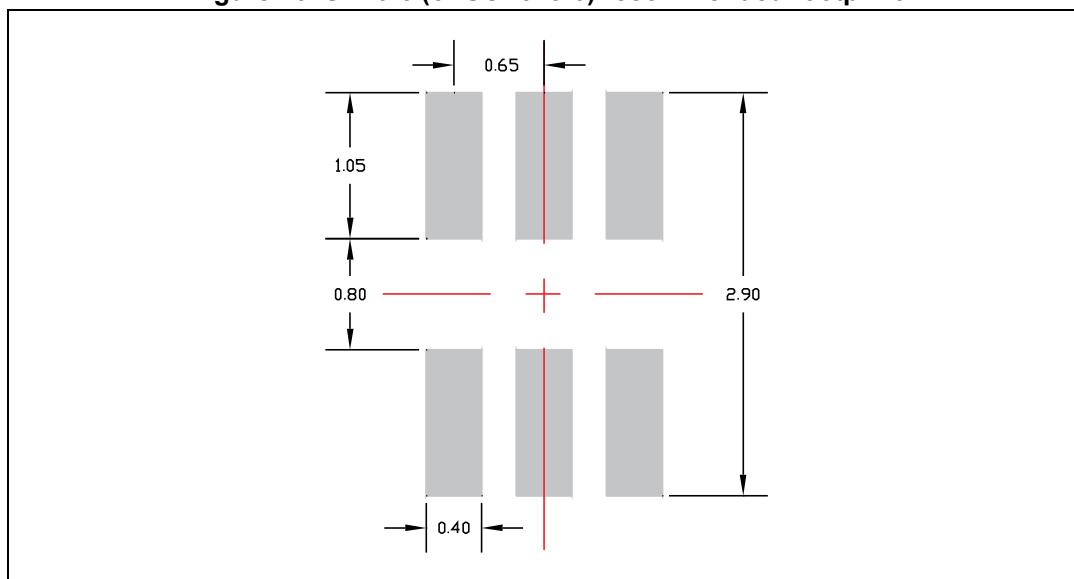

Table 11. SC70-6 (or SOT323-6) mechanical data

Ref	Dimensions					
	Millimeters			Inches		
	Min.	Typ.	Max.	Min.	Typ.	Max.
A	0.80		1.10	0.031		0.043
A1			0.10			0.004
A2	0.80		1.00	0.031		0.039
b	0.15		0.30	0.006		0.012
c	0.10		0.18	0.004		0.007
D	1.80		2.20	0.071		0.086
E	1.15		1.35	0.045		0.053
e		0.65			0.026	
HE	1.80		2.40	0.071		0.094
L	0.10		0.40	0.004		0.016
Q1	0.10		0.40	0.004		0.016

Figure 25. SC70-6 (or SOT323-6) recommended footprint



5 Ordering information

Table 12. Order codes

Part number	Temperature range	Package	Packing	Marking
TSV620ILT	-40 °C to 125 °C	SOT23-6	Tape and reel	K107
TSV620ICT		SC70-6		K14
TSV620AILT		SOT23-6		K110
TSV620AICT		SC70-6		K15
TSV621ILT		SOT23-5		K106
TSV621ICT		SC70-5		K16
TSV621AILT		SOT23-5		K139
TSV621AICT		SC70-5		K39

6 Revision history

Table 13. Document revision history

Date	Revision	Changes
12-Jan-2009	1	Initial release.
19-Oct-2009	2	Added TSV620 device (version with shutdown function). Added Table 4: Shutdown characteristics $V_{CC} = 1.8$ V. Added Table 7: Shutdown characteristics $V_{CC} = 5$ V. Added Section 3.4: Shutdown function (TSV620) on page 13. Added Section 4.2: SOT23-6 package mechanical data. Added Section 4.4: SC70-6 (or SOT323-6) package mechanical data. Added order codes in Table 12.
10-May-2017	3	<i>Table 3, Table 5, and Table 6</i> : changed " DV_{iO} " to " $\Delta V_{iO}/\Delta T$ ", updated V_{OH} parameter information, changed min. values for V_{OH} parameter to max. values. <i>Figure 21, Figure 22, Table 8, and Table 9</i> : removed "L" from titles