



TSW110



HARDWARE

FRONT VIEW

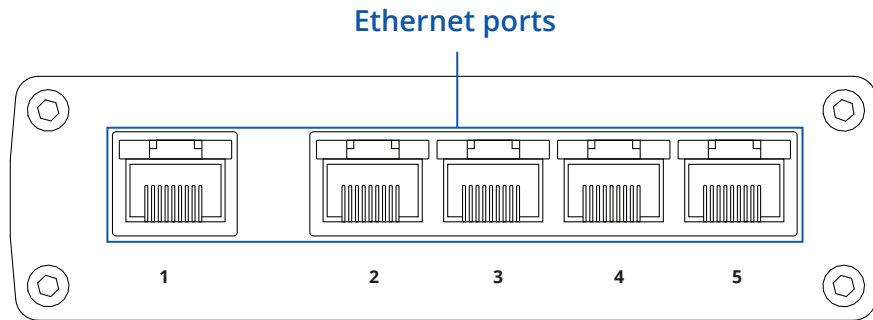

BACK VIEW

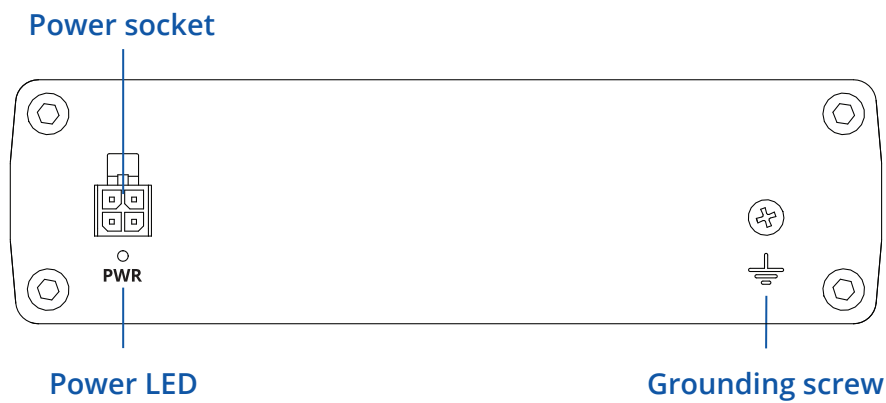

RJ45 LED MEANING

Orange LED on: link established
10/100/1000 Mbps
Orange LED blinking: active connection

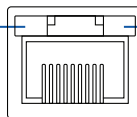

Green LED on: link established
1000Mbps

POWER SOCKET PINOUT

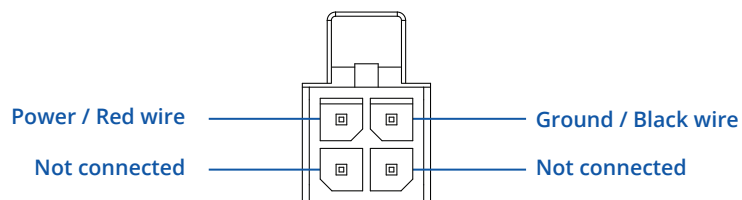

FEATURES

ETHERNET

LAN	5 x LAN ports, 10/100/1000 Mbps, compliance with IEEE 802.3, IEEE 802.3u, 802.3az standards, supports auto MDI/MDIX crossover
-----	---

PERFORMANCE SPECIFICATIONS

Bandwidth (Non-blocking)	10 Gbps
Packet buffer	128 KB
MAC address table size	2K entries
Connector	4 pin industrial DC power socket
Input voltage range	9 - 30 VDC, reverse polarity protection, voltage surge/transient protection
PoE (passive)	Passive PoE. Possibility to power up through LAN port, not compatible with IEEE802.3af, 802.3at and 802.3bt standards
Power consumption (idle/max)	< 0.4 W / <1.8 W

PHYSICAL INTERFACES (PORTS, LEDS)

Ethernet	5 x RJ45 ports, 10/100/1000 Mbps
Status LEDs	1 x Power LED, 10 x LAN status LED's
Power	1 x 4 pin DC connector
Ground	1 x Grounding screw

PHYSICAL SPECIFICATION

Casing material	Full aluminum housing
Dimensions (W x H x D)	100 x 30 x 85 mm
Weight	227 g
Mounting options	DIN rail or wall mounting (additional kit needed), flat surface placement

OPERATING ENVIRONMENT

Operating temperature	-40 C to 75 C
Operating humidity	10 % to 90 % non-condensing

HARDWARE INSTALLATION

1. Connect your main internet router/modem to TSW110 LAN port number 1.
2. Connect end devices (ex. Industrial PC, printers, IP phones, laptops) to TSW110 2 to 5 port.
3. Connect 4 pin power plug to TSW110 to power up switch.

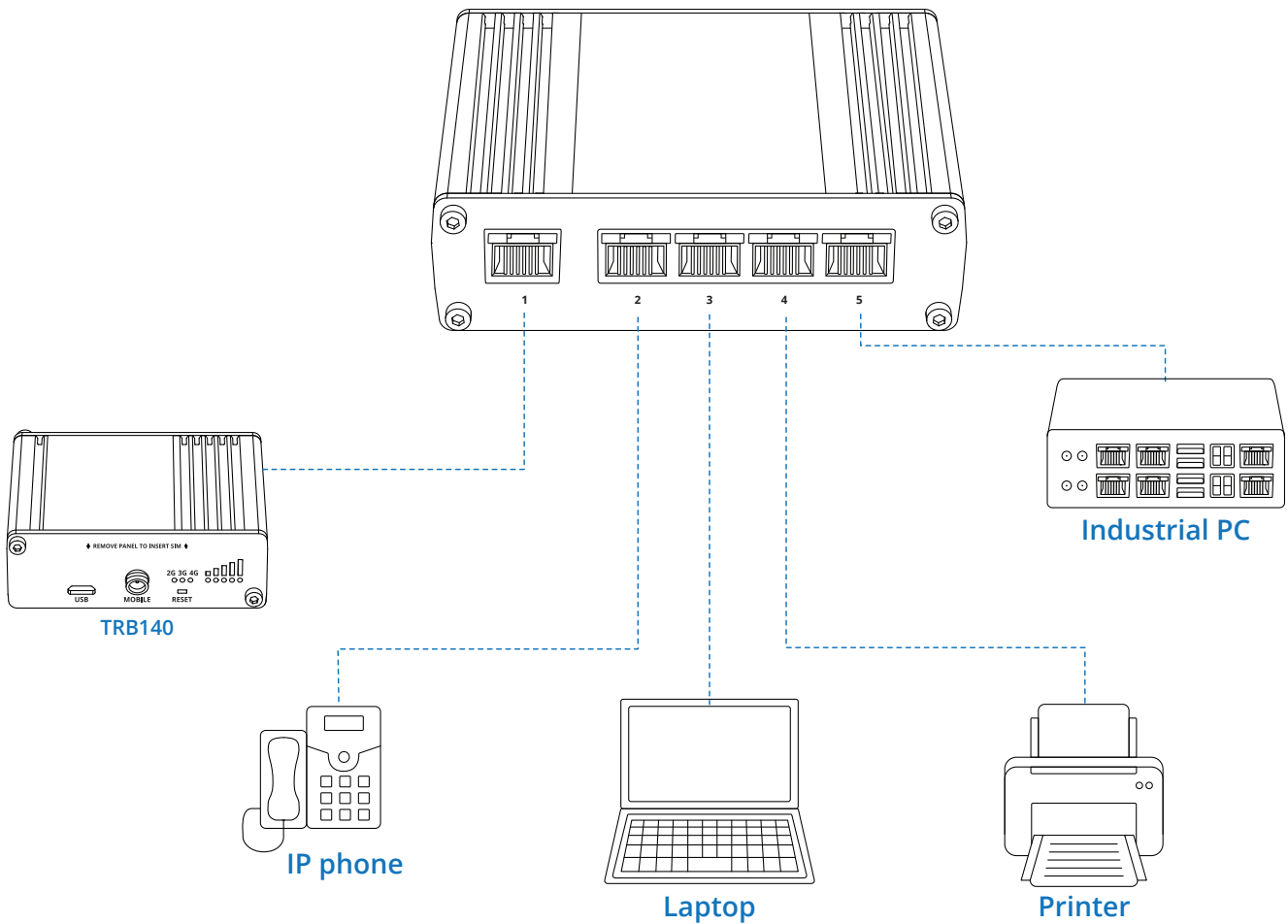

TECHNICAL INFORMATION

Technical specifications	
Input voltage range	9 - 30 VDC
Max power consumption	<1.8 W
Bundled accessories specifications*	
Power adapter	Input: 0.4 A @100-240 VAC, Output: 9 VDC, 1 A, 4 pin plug

* Order code dependent.

WHAT'S IN THE BOX?

STANDARD PACKAGE CONTAINS*

- TSW110
- 9 W PSU
- QSG (Quick Start Guide)
- Packaging box

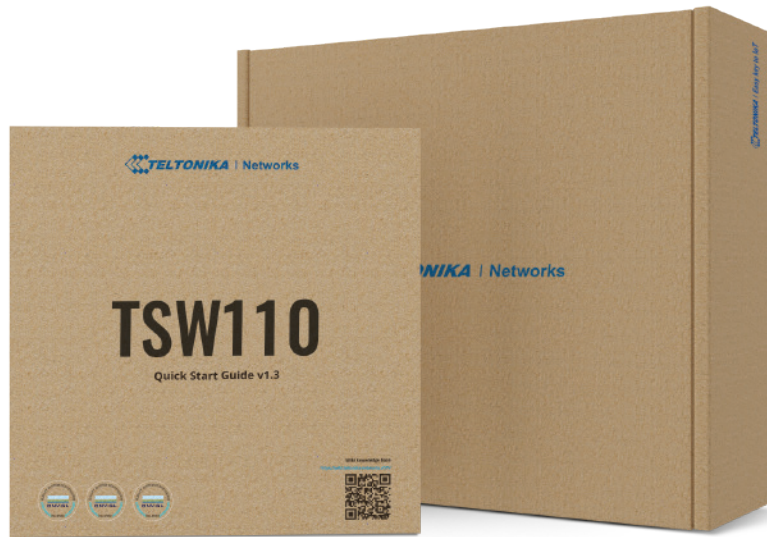

* For all standard order codes standard package contents are the same, except for PSU.

STANDARD ORDER CODES

PRODUCT CODE	HS CODE	HTS CODE	PACKAGE CONTAINS
TSW110000000	851762	8517.62.00	Standard package with Euro PSU
TSW110000010	851762	8517.62.00	Standard package with US PSU

For more information on all available packaging options – please contact us directly.

MOUNTING OPTIONS

DIN RAIL KIT

Parameter	Value
Mounting standard	35mm DIN Rail
Material	Low carbon steel
Weight	57g
Screws included	Philips Pan Head screw #6-32×3/16, 2pcs
Dimensions	82 mm x 46 mm x 20 mm
RoHS Compliant	V

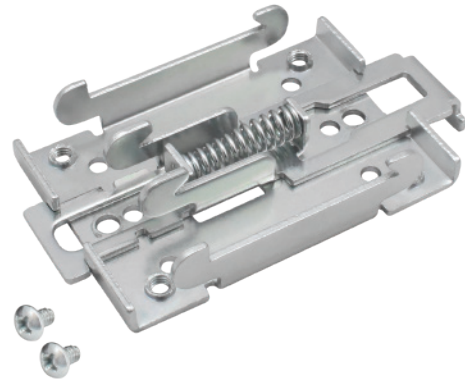

DIN RAIL KIT

- DIN Rail adapter
- Philips Pan Head screw #6-32×3/16, 2pcs for RUT2xx/RUT9xx

ORDER CODE

PR5MEC00

HS CODE

73269098

HTS CODE

7326.90.98

For more information on all available packaging options – please contact us directly.

COMPACT DIN RAIL KIT

Parameter	Value
Mounting standard	35mm DIN Rail
Material	ABS + PC plastic
Weight	6.5 g
Screws included	Philips Pan Head screw #6-32×3/16, 2pcs
Dimensions	70 mm x 25 mm x 14,5 mm
RoHS Compliant	V



DIN RAIL KIT

- Compact plastic DIN Rail adapter (70x25x14,5mm)
- Philips Pan Head screw #6-32×3/16, 2pcs

ORDER CODE

PR5MEC11

HS CODE

73269098

HTS CODE

7326.90.98

For more information on all available packaging options – please contact us directly.

SURFACE MOUNTING KIT

Parameter	Value
Mounting standard	Flat surface mount
Material	ABS + PC plastic
Weight	2x5 g
Screws included	Philips Pan Head screw #6-32×3/16, 2pcs
Dimensions	25 mm x 48 mm x 7.5 mm
RoHS Compliant	V



DIN RAIL KIT

- Surface mounting kit
- Philips Pan Head screw #6-32×3/16, 2pcs

ORDER CODE

PR5MEC12

HS CODE

73269098

HTS CODE

7326.90.98

For more information on all available packaging options – please contact us directly.

TSW110 SPATIAL MEASUREMENTS & WEIGHT

MAIN MEASUREMENTS

W x H x D dimensions for TSW110:

Device housing*: 100 x 30 x 85

Box: 173 x 71 x 148

*Housing measurements are presented without antenna connectors and screws; for measurements of other device elements look to the sections below.

TOP VIEW

The figure below depicts the measurements of TSW110 and its components as seen from the top:

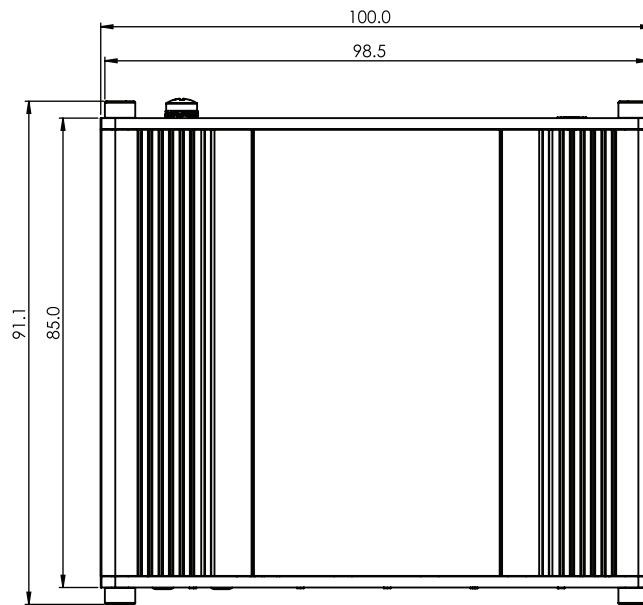

RIGHT VIEW

The figure below depicts the measurements of TSW110 and its components as seen from the right side:

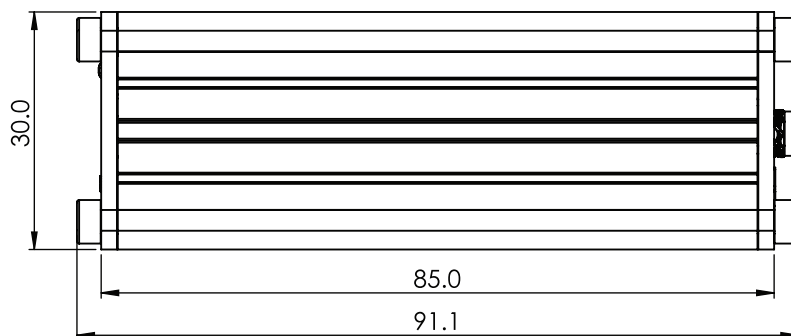

FRONT VIEW

The figure below depicts the measurements of TSW110 and its components as seen from the front panel side:

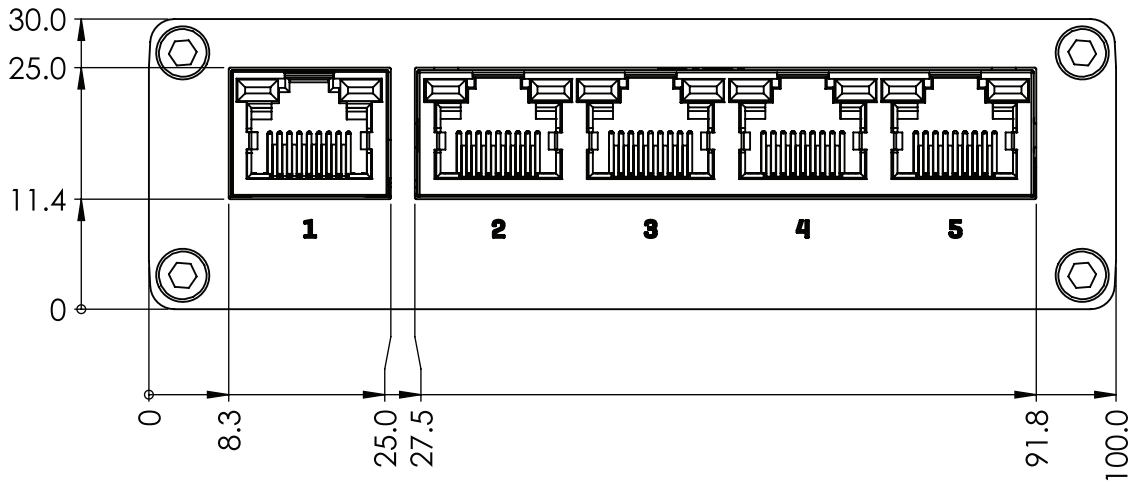

REAR VIEW

The figure below depicts the measurements of TSW110 and its components as seen from the back panel side:

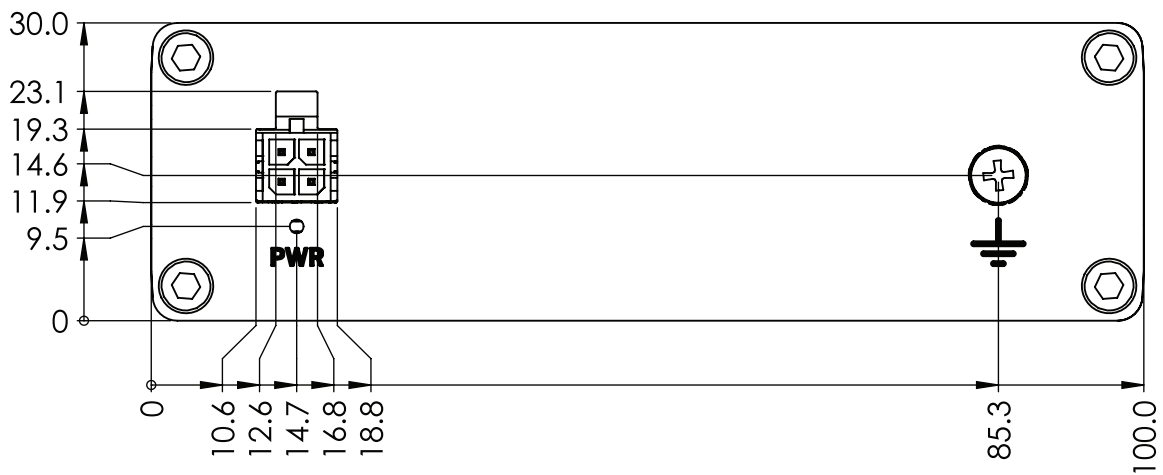

MOUNTING SPACE REQUIREMENTS

The figure below depicts an approximation of the device's dimensions when cables and antennas are attached:

