

Features

- Low power consumption: 60 μ A max at 16 V
- Supply voltage: 3.3 V to 16 V
- Rail-to-rail input and output
- Gain bandwidth product: 200 kHz typ
- Low offset voltage:
 - 500 μ V max for “A” version
 - 1 mV max for standard version
- Low input bias current: 1 pA typ
- Automotive qualification

Benefits

- Power savings in power-conscious applications
- Easy interfacing with high impedance sensors

Related products

- See TSX56x or TSX92x series for higher gain bandwidth products (900 kHz or 10 MHz)

Applications

- Industrial signal conditioning
- Automotive signal conditioning
- Active filtering
- Medical instrumentation
- High impedance sensors

Description

The TSX63x and TSX63xA series of operational amplifiers offer low voltage operation and rail-to-rail input and output. TSX631 is the single version, TSX632 the dual version and TSX634 the quad version, with pinouts compatible with industry standards.

The TSX63x and TSX63xA series offer a 200 kHz gain bandwidth product while consuming 60 μ A maximum at 16 V.

The devices are housed in the tiniest industrial packages.

These features make the TSX63x and TSX63xA family ideal for sensor interfaces and industrial signal conditioning. The wide temperature range and high ESD tolerance ease the use in harsh automotive applications.

Table 1. Device summary

Op-amp version	Standard V_{io}	Enhanced V_{io}
Single	TSX631	TSX631A
Dual	TSX632	TSX632A
Quad	TSX634	TSX634A

Contents

1	Package pin connections	3
2	Absolute maximum ratings and operating conditions	4
3	Electrical characteristics	5
4	Application information	18
	4.1 Operating voltages	18
	4.2 Rail-to-rail input	18
	4.3 Input offset voltage drift over temperature	18
	4.4 Long term input offset voltage drift	19
	4.5 High values of input differential voltage	20
	4.6 PCB layouts	20
	4.7 Macromodel	21
5	Package information	22
	5.1 SOT23-5 package information	23
	5.2 DFN8 2x2 package information	24
	5.3 MiniSO-8 package information	25
	5.4 QFN16 3x3 package information	26
	5.5 TSSOP14 package information	28
6	Ordering information	29
7	Revision history	30

1 Package pin connections

Figure 1. Pin connections for each package (top view)

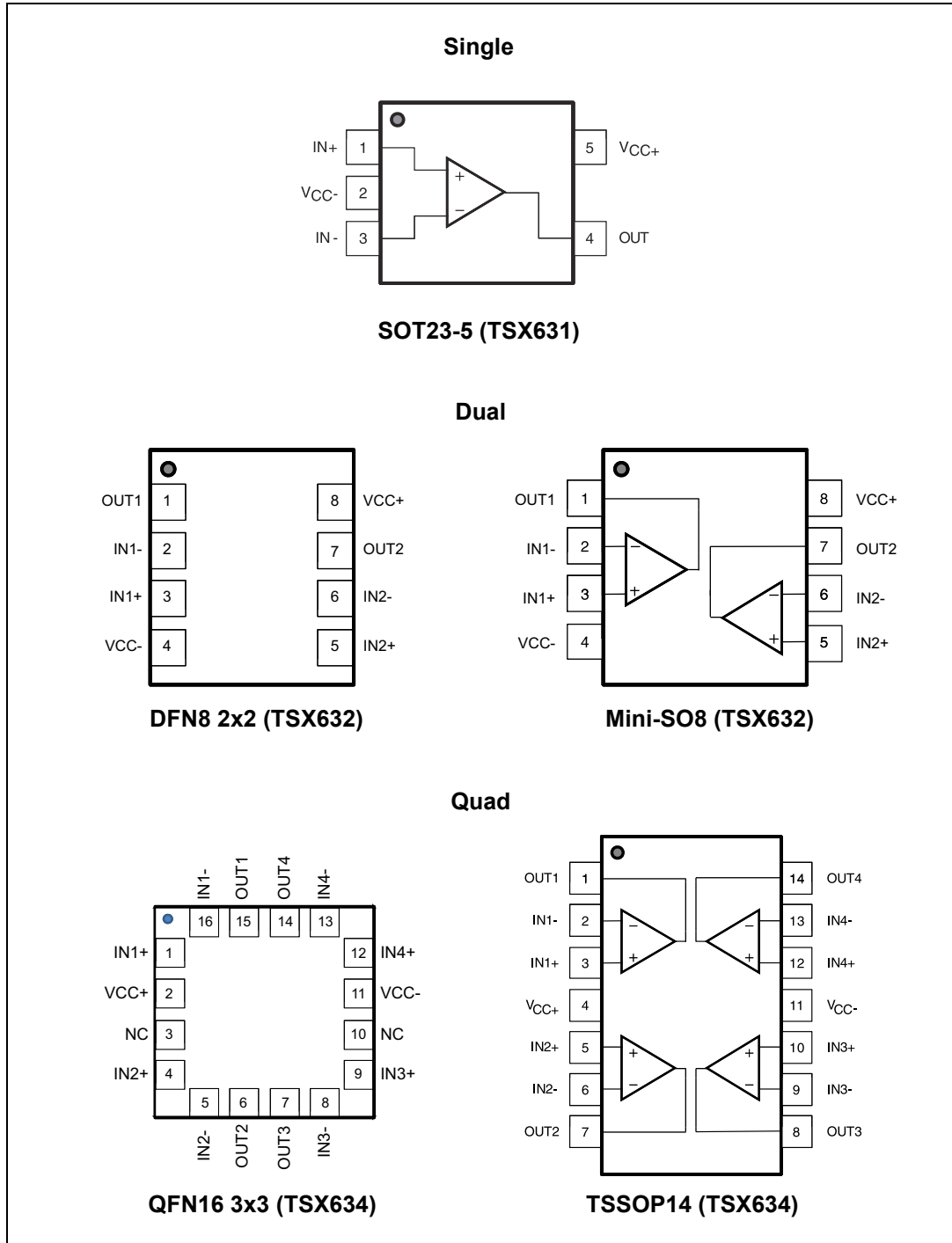

2 Absolute maximum ratings and operating conditions

Table 2. Absolute maximum ratings (AMR)

Symbol	Parameter	Value	Unit
V_{CC}	Supply voltage ⁽¹⁾	18	V
V_{id}	Differential input voltage ⁽²⁾	$\pm V_{CC}$	
V_{in}	Input voltage ⁽³⁾	$V_{CC-} - 0.2$ to $V_{CC+} + 0.2$	
I_{in}	Input current ⁽⁴⁾	10	mA
T_{stg}	Storage temperature	-65 to +150	°C
R_{thja}	Thermal resistance junction to ambient ⁽⁵⁾⁽⁶⁾		°C/W
	SOT23-5	250	
	DFN8 2x2	120	
	MiniSO-8	190	
	QFN16 3x3	80	
R_{thjc}	Thermal resistance junction to case		°C/W
	DFN8 2x2	33	
	QFN16 3x3	30	
T_j	Maximum junction temperature	160	°C
ESD	HBM: human body model ⁽⁷⁾	4	kV
	MM: machine model ⁽⁸⁾	200	V
	CDM: charged device model ⁽⁹⁾	1.3	kV
	Latch-up immunity	200	mA

1. All voltage values, except the differential voltage are with respect to network ground terminal.
2. The differential voltage is the non-inverting input terminal with respect to the inverting input terminal. See [Section 4.5](#) for precautions of using the TSX631 with high differential input voltage.
3. $V_{CC-} - V_{in}$ must not exceed 18 V, V_{in} must not exceed 18 V.
4. Input current must be limited by a resistor in series with the inputs.
5. Short-circuits can cause excessive heating and destructive dissipation.
6. R_{th} are typical values.
7. Human body model: 100 pF discharged through a 1.5 kΩ resistor between two pins of the device, done for all couples of pin combinations with other pins floating.
8. Machine model: a 200 pF cap is charged to the specified voltage, then discharged directly between two pins of the device with no external series resistor (internal resistor < 5 Ω), done for all couples of pin combinations with other pins floating.
9. Charged device model: all pins plus package are charged together to the specified voltage and then discharged directly to the ground.

Table 3. Operating conditions

Symbol	Parameter	Value	Unit
V_{CC}	Supply voltage	3.3 to 16	V
V_{icm}	Common mode input voltage range	$V_{CC-} - 0.1$ to $V_{CC+} + 0.1$	
T_{oper}	Operating free air temperature range	-40 to +125	°C

3 Electrical characteristics

Table 4. Electrical characteristics at $V_{CC+} = +3.3\text{ V}$ with $V_{CC-} = 0\text{ V}$, $V_{icm} = V_{CC}/2$, $T = 25\text{ }^\circ\text{C}$, and $R_L = 10\text{ k}\Omega$ connected to $V_{CC}/2$ (unless otherwise specified)

Symbol	Parameter	Conditions	Min.	Typ.	Max.	Unit
DC performance						
V_{io}	Offset voltage	TSX63xA, $T = 25\text{ }^\circ\text{C}$			700	μV
		TSX63xA, $-40\text{ }^\circ\text{C} < T < 125\text{ }^\circ\text{C}$			1500	
		TSX63x, $T = 25\text{ }^\circ\text{C}$			1.6	mV
		TSX63x, $-40\text{ }^\circ\text{C} < T < 125\text{ }^\circ\text{C}$			2.4	
V_{io}	Offset voltage, high common mode ($V_{icm} = V_{CC}$, $R_L > 1\text{ M}\Omega$)	$T = 25\text{ }^\circ\text{C}$			4	mV
		$-40\text{ }^\circ\text{C} < T < 125\text{ }^\circ\text{C}$			5	
$\Delta V_{io}/\Delta T$	Input offset voltage drift	$-40\text{ }^\circ\text{C} < T < 125\text{ }^\circ\text{C}^{(1)}$		1	8	$\mu\text{V}/^\circ\text{C}$
I_{io}	Input offset current ($V_{out} = V_{CC}/2$)	$T = 25\text{ }^\circ\text{C}$		1	$100^{(2)}$	pA
		$-40\text{ }^\circ\text{C} < T < 125\text{ }^\circ\text{C}$			$200^{(2)}$	
I_{ib}	Input bias current ($V_{out} = V_{CC}/2$)	$T = 25\text{ }^\circ\text{C}$		1	$100^{(2)}$	pA
		$-40\text{ }^\circ\text{C} < T < 125\text{ }^\circ\text{C}$			$200^{(2)}$	
R_{IN}	Input resistance			1		$\text{T}\Omega$
C_{IN}	Input capacitance			5		pF
CMR1	Common mode rejection ratio CMR = $20 \log(\Delta V_{icm}/\Delta V_{io})$ ($V_{icm} = -0.1\text{ V}$ to $V_{CC}-1.65\text{ V}$, $V_{out} = V_{CC}/2$, $R_L > 1\text{ M}\Omega$)	$T = 25\text{ }^\circ\text{C}$	65	79		dB
		$-40\text{ }^\circ\text{C} < T < 125\text{ }^\circ\text{C}$	62			
CMR2	Common mode rejection ratio CMR = $20 \log(\Delta V_{icm}/\Delta V_{io})$ ($V_{icm} = -0.1\text{ V}$ to $V_{CC}+0.1\text{ V}$, $V_{out} = V_{CC}/2$, $R_L > 1\text{ M}\Omega$)	$T = 25\text{ }^\circ\text{C}$	59	74		dB
		$-40\text{ }^\circ\text{C} < T < 125\text{ }^\circ\text{C}$	55			
A_{vd}	Large signal voltage gain ($V_{out} = 0.5\text{ V}$ to $(V_{CC} - 0.5\text{ V})$, $R_L > 1\text{ M}\Omega$)	$T = 25\text{ }^\circ\text{C}$	100	110		dB
		$-40\text{ }^\circ\text{C} < T < 125\text{ }^\circ\text{C}$	90			
V_{OH}	High level output voltage $V_{id} = +1\text{ V}$, $V_{OH} = V_{CC} - V_{out}$	$R_L = 10\text{ k}\Omega$, $T = 25\text{ }^\circ\text{C}$			70	mV
		$R_L = 10\text{ k}\Omega$, $-40\text{ }^\circ\text{C} < T < 125\text{ }^\circ\text{C}$			100	
V_{OL}	Low level output voltage $V_{id} = -1\text{ V}$,	$R_L = 10\text{ k}\Omega$, $T = 25\text{ }^\circ\text{C}$			70	mV
		$R_L = 10\text{ k}\Omega$, $-40\text{ }^\circ\text{C} < T < 125\text{ }^\circ\text{C}$			100	
I_{out}	I_{sink} ($V_{out} = V_{CC}$)	$T = 25\text{ }^\circ\text{C}$	4.3	5.3		mA
		$-40\text{ }^\circ\text{C} < T < 125\text{ }^\circ\text{C}$	2.5			
	I_{source} ($V_{out} = 0\text{ V}$)	$T = 25\text{ }^\circ\text{C}$	3.3	4.3		
		$-40\text{ }^\circ\text{C} < T < 125\text{ }^\circ\text{C}$	2.5			
I_{CC}	Supply current (per operator, $V_{out} = V_{CC}/2$, $R_L > 1\text{ M}\Omega$)	$T = 25\text{ }^\circ\text{C}$		45	60	μA
		$-40\text{ }^\circ\text{C} < T < 125\text{ }^\circ\text{C}$			60	

Table 4. Electrical characteristics at $V_{CC+} = +3.3\text{ V}$ with $V_{CC-} = 0\text{ V}$, $V_{icm} = V_{CC}/2$, $T = 25\text{ }^\circ\text{C}$, and $R_L = 10\text{ k}\Omega$ connected to $V_{CC}/2$ (unless otherwise specified)

Symbol	Parameter	Conditions	Min.	Typ.	Max.	Unit
AC performance						
GBP	Gain bandwidth product	$R_L = 100\text{ k}\Omega$, $C_L = 100\text{ pF}$	160	200		kHz
F_u	Unity gain frequency			160		
Φ_m	Phase margin			55		degrees
G_m	Gain margin			9		dB
SR	Slew rate	$R_L = 100\text{ k}\Omega$, $C_L = 100\text{ pF}$, $V_{out} = 0.5\text{ V}$ to $V_{CC} - 0.5\text{ V}$		0.12		V/ μs
$\int e_n$	Low-frequency peak-to-peak input noise	Bandwidth: $f = 0.1$ to 10 Hz		5		μV_{pp}
e_n	Equivalent input noise voltage	$f = 1\text{ kHz}$		60		$\frac{\text{nV}}{\sqrt{\text{Hz}}}$
		$f = 10\text{ kHz}$				
THD+N	Total harmonic distortion + noise	Follower configuration, $f_{in} = 1\text{ kHz}$, $R_L = 100\text{ k}\Omega$, $V_{icm} = 0.9\text{ V}$, $\text{BW} = 22\text{ kHz}$, $V_{out} = 1\text{ V}_{pp}$		0.005		%

1. See [Chapter 4.3: Input offset voltage drift over temperature on page 18](#)
2. Guaranteed by design

Table 5. Electrical characteristics at $V_{CC+} = +5\text{ V}$ with $V_{CC-} = 0\text{ V}$, $V_{icm} = V_{CC}/2$, $T = 25\text{ }^\circ\text{C}$, and $R_L = 10\text{ k}\Omega$ connected to $V_{CC}/2$ (unless otherwise specified)

Symbol	Parameter	Conditions	Min.	Typ.	Max.	Unit
DC performance						
V_{io}	Offset voltage	TSX63xA, $T = 25\text{ }^\circ\text{C}$			700	μV
		TSX63xA, $-40\text{ }^\circ\text{C} < T < 125\text{ }^\circ\text{C}$			1500	
		TSX63x, $T = 25\text{ }^\circ\text{C}$			1.6	mV
		TSX63x, $-40\text{ }^\circ\text{C} < T < 125\text{ }^\circ\text{C}$			2.4	
V_{io}	Offset voltage, high common mode ($V_{icm} = V_{CC}$, $R_L > 1\text{ M}\Omega$)	$T = 25\text{ }^\circ\text{C}$			4	mV
		$-40\text{ }^\circ\text{C} < T < 125\text{ }^\circ\text{C}$			5	
$\Delta V_{io}/\Delta T$	Input offset voltage drift	$-40\text{ }^\circ\text{C} < T < 125\text{ }^\circ\text{C}^{(1)}$		1	8	$\mu\text{V}/^\circ\text{C}$
ΔV_{io}	Long term input offset voltage drift	$T = 25\text{ }^\circ\text{C}^{(2)}$		17		$\frac{\text{nV}}{\sqrt{\text{month}}}$
I_{io}	Input offset current ($V_{out} = V_{CC}/2$)	$T = 25\text{ }^\circ\text{C}$		1	$100^{(3)}$	pA
		$-40\text{ }^\circ\text{C} < T < 125\text{ }^\circ\text{C}$			$200^{(3)}$	
I_{ib}	Input bias current ($V_{out} = V_{CC}/2$)	$T = 25\text{ }^\circ\text{C}$		1	$100^{(3)}$	
		$-40\text{ }^\circ\text{C} < T < 125\text{ }^\circ\text{C}$			$200^{(3)}$	
R_{IN}	Input resistance			1		T Ω
C_{IN}	Input capacitance			5		pF
CMR1	Common mode rejection ratio $\text{CMR} = 20 \log (\Delta V_{icm}/\Delta V_{io})$ ($V_{icm} = -0.1\text{ V}$ to $V_{CC}-1.65\text{ V}$, $V_{out} = V_{CC}/2$, $R_L > 1\text{ M}\Omega$)	$T = 25\text{ }^\circ\text{C}$	65	79		dB
		$-40\text{ }^\circ\text{C} < T < 125\text{ }^\circ\text{C}$	62			
CMR2	Common mode rejection ratio $\text{CMR} = 20 \log (\Delta V_{icm}/\Delta V_{io})$ ($V_{icm} = -0.1\text{ V}$ to $V_{CC}+0.1\text{ V}$, $V_{out} = V_{CC}/2$, $R_L > 1\text{ M}\Omega$)	$T = 25\text{ }^\circ\text{C}$	62	77		
		$-40\text{ }^\circ\text{C} < T < 125\text{ }^\circ\text{C}$	58			
A_{vd}	Large signal voltage gain ($V_{out} = 0.5\text{ V}$ to $(V_{CC} - 0.5\text{ V})$, $R_L > 1\text{ M}\Omega$)	$T = 25\text{ }^\circ\text{C}$	100	110		
		$-40\text{ }^\circ\text{C} < T < 125\text{ }^\circ\text{C}$	90			
V_{OH}	High level output voltage $V_{id} = +1\text{ V}$, $V_{OH} = V_{CC}-V_{out}$	$R_L = 10\text{ k}\Omega$, $T = 25\text{ }^\circ\text{C}$			70	mV
		$R_L = 10\text{ k}\Omega$, $-40\text{ }^\circ\text{C} < T < 125\text{ }^\circ\text{C}$			100	
V_{OL}	Low level output voltage $V_{id} = -1\text{ V}$,	$R_L = 10\text{ k}\Omega$, $T = 25\text{ }^\circ\text{C}$			70	
		$R_L = 10\text{ k}\Omega$, $-40\text{ }^\circ\text{C} < T < 125\text{ }^\circ\text{C}$			100	
I_{out}	I_{sink} ($V_{out} = V_{CC}$)	$T = 25\text{ }^\circ\text{C}$	11	14		mA
		$-40\text{ }^\circ\text{C} < T < 125\text{ }^\circ\text{C}$	8			
	I_{source} ($V_{out} = 0\text{ V}$)	$T = 25\text{ }^\circ\text{C}$	9	12		
		$-40\text{ }^\circ\text{C} < T < 125\text{ }^\circ\text{C}$	7			
I_{CC}	Supply current (per operator, $V_{out} = V_{CC}/2$, $R_L > 1\text{ M}\Omega$)	$T = 25\text{ }^\circ\text{C}$		45	60	μA
		$-40\text{ }^\circ\text{C} < T < 125\text{ }^\circ\text{C}$			60	

Table 5. Electrical characteristics at $V_{CC+} = +5\text{ V}$ with $V_{CC-} = 0\text{ V}$, $V_{icm} = V_{CC}/2$, $T = 25\text{ }^\circ\text{C}$, and $R_L = 10\text{ k}\Omega$ connected to $V_{CC}/2$ (unless otherwise specified)

Symbol	Parameter	Conditions	Min.	Typ.	Max.	Unit
AC performance						
GBP	Gain bandwidth product	$R_L = 100\text{ k}\Omega$, $C_L = 100\text{ pF}$	160	200		kHz
F_u	Unity gain frequency			160		
Φ_m	Phase margin			55		degrees
G_m	Gain margin			9		dB
SR	Slew rate	$R_L = 100\text{ k}\Omega$, $C_L = 100\text{ pF}$, $V_{out} = 0.5\text{ V to }V_{CC} - 0.5\text{ V}$		0.12		V/ μs
$\int e_n$	Low-frequency peak-to-peak input noise	Bandwidth: $f = 0.1\text{ to }10\text{ Hz}$		5		μV_{pp}
e_n	Equivalent input noise voltage	$f = 1\text{ kHz}$		60		$\frac{\text{nV}}{\sqrt{\text{Hz}}}$
		$f = 10\text{ kHz}$				
THD+N	Total harmonic distortion + noise	Follower configuration, $f_{in} = 1\text{ kHz}$, $R_L = 100\text{ k}\Omega$, $V_{icm} = 2.5\text{ V}$, $\text{BW} = 22\text{ kHz}$, $V_{out} = 1\text{ V}_{pp}$		0.005		%

1. See [Chapter 4.3: Input offset voltage drift over temperature on page 18](#)
2. Typical value is based on the V_{io} drift observed after 1000h at 125°C extrapolated to 25°C using the Arrhenius law and assuming an activation energy of 0.7 eV. The operational amplifier is aged in follower mode configuration. See [Chapter 4.4: Long term input offset voltage drift on page 19](#).
3. Guaranteed by design

Table 6. Electrical characteristics at $V_{CC+} = +10\text{ V}$ with $V_{CC-} = 0\text{ V}$, $V_{icm} = V_{CC}/2$, $T = 25\text{ }^\circ\text{C}$, and $R_L = 10\text{ k}\Omega$ connected to $V_{CC}/2$ (unless otherwise specified)

Symbol	Parameter	Conditions	Min.	Typ.	Max.	Unit
DC performance						
V_{io}	Offset voltage	TSX63xA, $T = 25\text{ }^\circ\text{C}$			500	μV
		TSX63xA, $-40\text{ }^\circ\text{C} < T < 125\text{ }^\circ\text{C}$			1300	
		TSX63x, $T = 25\text{ }^\circ\text{C}$			1	mV
		TSX63x, $-40\text{ }^\circ\text{C} < T < 125\text{ }^\circ\text{C}$			1.8	
V_{io}	Offset voltage, high common mode ($V_{icm} = V_{CC}$, $R_L > 1\text{ M}\Omega$)	$T = 25\text{ }^\circ\text{C}$			4	mV
		$-40\text{ }^\circ\text{C} < T < 125\text{ }^\circ\text{C}$			5	
$\Delta V_{io}/\Delta T$	Input offset voltage drift	$-40\text{ }^\circ\text{C} < T < 125\text{ }^\circ\text{C}^{(1)}$		1	8	$\mu\text{V}/^\circ\text{C}$
ΔV_{io}	Long term input offset voltage drift	$T = 25\text{ }^\circ\text{C}^{(2)}$		180		$\frac{\text{nV}}{\sqrt{\text{month}}}$
I_{io}	Input offset current ($V_{out} = V_{CC}/2$)	$T = 25\text{ }^\circ\text{C}$		1	$100^{(3)}$	pA
		$-40\text{ }^\circ\text{C} < T < 125\text{ }^\circ\text{C}$			$200^{(3)}$	
I_{ib}	Input bias current ($V_{out} = V_{CC}/2$)	$T = 25\text{ }^\circ\text{C}$		1	$100^{(3)}$	pA
		$-40\text{ }^\circ\text{C} < T < 125\text{ }^\circ\text{C}$			$200^{(3)}$	
R_{iN}	Input resistance			1		T Ω
C_{iN}	Input capacitance			5		pF
CMR1	Common mode rejection ratio $\text{CMR} = 20 \log (\Delta V_{icm}/\Delta V_{io})$ ($V_{icm} = -0.1\text{ V}$ to $V_{CC}-1.65\text{ V}$, $V_{out} = V_{CC}/2$, $R_L > 1\text{ M}\Omega$)	$T = 25\text{ }^\circ\text{C}$	71	84		dB
		$-40\text{ }^\circ\text{C} < T < 125\text{ }^\circ\text{C}$	68			
CMR2	Common mode rejection ratio $\text{CMR} = 20 \log (\Delta V_{icm}/\Delta V_{io})$ ($V_{icm} = -0.1\text{ V}$ to $V_{CC}+0.1\text{ V}$, $V_{out} = V_{CC}/2$, $R_L > 1\text{ M}\Omega$)	$T = 25\text{ }^\circ\text{C}$	69	82		dB
		$-40\text{ }^\circ\text{C} < T < 125\text{ }^\circ\text{C}$	66			
A_{vd}	Large signal voltage gain ($V_{out} = 0.5\text{ V}$ to $(V_{CC} - 0.5\text{ V})$, $R_L > 1\text{ M}\Omega$)	$T = 25\text{ }^\circ\text{C}$	100	110		dB
		$-40\text{ }^\circ\text{C} < T < 125\text{ }^\circ\text{C}$	90			
V_{OH}	High level output voltage $V_{id} = +1\text{ V}$, $V_{OH} = V_{CC} - V_{out}$	$R_L = 10\text{ k}\Omega$, $T = 25\text{ }^\circ\text{C}$			70	mV
		$R_L = 10\text{ k}\Omega$, $-40\text{ }^\circ\text{C} < T < 125\text{ }^\circ\text{C}$			100	
V_{OL}	Low level output voltage $V_{id} = -1\text{ V}$,	$R_L = 10\text{ k}\Omega$, $T = 25\text{ }^\circ\text{C}$			70	mV
		$R_L = 10\text{ k}\Omega$, $-40\text{ }^\circ\text{C} < T < 125\text{ }^\circ\text{C}$			100	
I_{out}	I_{sink} ($V_{out} = V_{CC}$)	$T = 25\text{ }^\circ\text{C}$	35	51		mA
		$-40\text{ }^\circ\text{C} < T < 125\text{ }^\circ\text{C}$	25			
	I_{source} ($V_{out} = 0\text{ V}$)	$T = 25\text{ }^\circ\text{C}$	30	42		
		$-40\text{ }^\circ\text{C} < T < 125\text{ }^\circ\text{C}$	20			
I_{CC}	Supply current (per operator, $V_{out} = V_{CC}/2$, $R_L > 1\text{ M}\Omega$)	$T = 25\text{ }^\circ\text{C}$		45	60	μA
		$-40\text{ }^\circ\text{C} < T < 125\text{ }^\circ\text{C}$			60	

Table 6. Electrical characteristics at $V_{CC+} = +10\text{ V}$ with $V_{CC-} = 0\text{ V}$, $V_{icm} = V_{CC}/2$, $T = 25\text{ ° C}$, and $R_L = 10\text{ k}\Omega$ connected to $V_{CC}/2$ (unless otherwise specified)

Symbol	Parameter	Conditions	Min.	Typ.	Max.	Unit
AC performance						
GBP	Gain bandwidth product	$R_L = 100\text{ k}\Omega$, $C_L = 100\text{ pF}$	160	200		kHz
F_u	Unity gain frequency			160		
Φ_m	Phase margin			55		degrees
G_m	Gain margin			9		dB
SR	Slew rate	$R_L = 100\text{ k}\Omega$, $C_L = 100\text{ pF}$, $V_{out} = 0.5\text{ V to }V_{CC} - 0.5\text{V}$		0.12		V/ μs
$\int e_n$	Low-frequency peak-to-peak input noise	Bandwidth: $f = 0.1\text{ to }10\text{ Hz}$		5		μV_{pp}
e_n	Equivalent input noise voltage	$f = 1\text{ kHz}$		60		$\frac{\text{nV}}{\sqrt{\text{Hz}}}$
		$f = 10\text{ kHz}$				
THD+N	Total harmonic distortion + noise	Follower configuration, $f_{in} = 1\text{ kHz}$, $R_L = 100\text{ k}\Omega$, $V_{icm} = 5\text{ V}$, $\text{BW} = 22\text{ kHz}$, $V_{out} = 1\text{ V}_{pp}$		0.004		%

1. See [Chapter 4.3: Input offset voltage drift over temperature on page 18](#)
2. Typical value is based on the V_{io} drift observed after 1000h at 125°C extrapolated to 25°C using the Arrhenius law and assuming an activation energy of 0.7 eV. The operational amplifier is aged in follower mode configuration. See [Chapter 4.4: Long term input offset voltage drift on page 19](#).
3. Guaranteed by design

Table 7. Electrical characteristics at $V_{CC+} = +16\text{ V}$ with $V_{CC-} = 0\text{ V}$, $V_{icm} = V_{CC}/2$, $T = 25\text{ °C}$, and $R_L = 10\text{ k}\Omega$ connected to $V_{CC}/2$ (unless otherwise specified)

Symbol	Parameter	Conditions	Min.	Typ.	Max.	Unit
DC performance						
V_{io}	Offset voltage	TSX63xA, $T = 25\text{ °C}$			700	μV
		TSX63xA, $-40\text{ °C} < T < 125\text{ °C}$			1500	
			$T = 25\text{ °C}$			1.6
	$-40\text{ °C} < T < 125\text{ °C}$			2.4		
V_{io}	Offset voltage, high common-mode ($V_{icm} = V_{CC}$, $R_L > 1\text{ M}\Omega$)	$T = 25\text{ °C}$			4	mV
		$-40\text{ °C} < T < 125\text{ °C}$			5	
$\Delta V_{io}/\Delta T$	Input offset voltage drift	$-40\text{ °C} < T < 125\text{ °C}^{(1)}$		1	8	$\mu\text{V}/\text{°C}$
ΔV_{io}	Long term input offset voltage drift	$T = 25\text{ °C}^{(2)}$		3.4		$\frac{\mu\text{V}}{\sqrt{\text{month}}}$
I_{io}	Input offset current ($V_{out} = V_{CC}/2$)	$T = 25\text{ °C}$		1	100 ⁽³⁾	pA
		$-40\text{ °C} < T < 125\text{ °C}$			200 ⁽³⁾	
I_{ib}	Input bias current ($V_{out} = V_{CC}/2$)	$T = 25\text{ °C}$		1	100 ⁽³⁾	pA
		$-40\text{ °C} < T < 125\text{ °C}$			200 ⁽³⁾	
R_{IN}	Input resistance			1		T Ω
C_{IN}	Input capacitance			5		pF
CMR1	Common mode rejection ratio $CMR = 20 \log (\Delta V_{icm}/\Delta V_{io})$ ($V_{icm} = -0.1\text{ V}$ to $V_{CC}-1.65\text{ V}$, $V_{out} = V_{CC}/2$, $R_L > 1\text{ M}\Omega$)	$T = 25\text{ °C}$	71	85		dB
		$-40\text{ °C} < T < 125\text{ °C}$	68			
CMR2	Common mode rejection ratio $CMR = 20 \log (\Delta V_{icm}/\Delta V_{io})$ ($V_{icm} = -0.1\text{ V}$ to $V_{CC}+0.1\text{ V}$, $V_{out} = V_{CC}/2$, $R_L > 1\text{ M}\Omega$)	$T = 25\text{ °C}$	69	83		dB
		$-40\text{ °C} < T < 125\text{ °C}$	66			
SVR	Common mode rejection ratio $20 \log (\Delta V_{CC}/\Delta V_{io})$ ($V_{CC} = 3.3\text{ V}$ to 16 V , $V_{out} = V_{icm} = V_{CC}/2$)	$T = 25\text{ °C}$	73	87		dB
		$-40\text{ °C} < T < 125\text{ °C}$	70			
A_{vd}	Large signal voltage gain ($V_{out} = 0.5\text{ V}$ to $(V_{CC} - 0.5\text{ V})$, $R_L > 1\text{ M}\Omega$)	$T = 25\text{ °C}$	100	110		dB
		$-40\text{ °C} < T < 125\text{ °C}$	90			
V_{OH}	High level output voltage $V_{id} = +1\text{ V}$, $V_{OH} = V_{CC} - V_{out}$	$R_L = 10\text{ k}\Omega$, $T = 25\text{ °C}$			70	mV
		$R_L = 10\text{ k}\Omega$, $-40\text{ °C} < T < 125\text{ °C}$			100	
V_{OL}	Low level output voltage $V_{id} = -1\text{ V}$,	$R_L = 10\text{ k}\Omega$, $T = 25\text{ °C}$			70	mV
		$R_L = 10\text{ k}\Omega$, $-40\text{ °C} < T < 125\text{ °C}$			100	

Table 7. Electrical characteristics at $V_{CC+} = +16\text{ V}$ with $V_{CC-} = 0\text{ V}$, $V_{icm} = V_{CC}/2$, $T = 25\text{ }^\circ\text{C}$, and $R_L = 10\text{ k}\Omega$ connected to $V_{CC}/2$ (unless otherwise specified)

Symbol	Parameter	Conditions	Min.	Typ.	Max.	Unit
I_{out}	I_{sink}	$V_{out} = V_{CC}$, $T = 25\text{ }^\circ\text{C}$	40	92		mA
		$V_{out} = V_{CC}$, $-40\text{ }^\circ\text{C} < T < 125\text{ }^\circ\text{C}$	35			
	I_{source}	$V_{out} = 0\text{ V}$, $T = 25\text{ }^\circ\text{C}$	30	90		
		$V_{out} = 0\text{ V}$, $-40\text{ }^\circ\text{C} < T < 125\text{ }^\circ\text{C}$	25			
I_{CC}	Supply current (per operator, $V_{out} = V_{CC}/2$, $R_L > 1\text{ M}\Omega$)	$T = 25\text{ }^\circ\text{C}$		45	60	μA
		$-40\text{ }^\circ\text{C} < T < 125\text{ }^\circ\text{C}$			60	
AC performance						
GBP	Gain bandwidth product	$R_L = 100\text{ k}\Omega$, $C_L = 100\text{ pF}$	160	200		kHz
F_u	Unity gain frequency			160		
Φ_m	Phase margin			55		degrees
G_m	Gain margin			9		dB
SR	Slew rate	$R_L = 100\text{ k}\Omega$, $C_L = 100\text{ pF}$, $V_{out} = 0.5\text{ V to } V_{CC} - 0.5\text{ V}$		0.12		$\text{V}/\mu\text{s}$
$\int e_n$	Low-frequency peak-to-peak input noise	Bandwidth: $f = 0.1\text{ to } 10\text{ Hz}$		5		μV_{pp}
e_n	Equivalent input noise voltage	$f = 1\text{ kHz}$		60		$\frac{\text{nV}}{\sqrt{\text{Hz}}}$
		$f = 10\text{ kHz}$				
THD+N	Total harmonic distortion + noise	Follower configuration, $f_{in} = 1\text{ kHz}$, $R_L = 100\text{ k}\Omega$, $V_{icm} = 8\text{ V}$, $\text{BW} = 22\text{ kHz}$, $V_{out} = 1\text{ V}_{pp}$		0.004		%

1. See [Chapter 4.3: Input offset voltage drift over temperature on page 18](#)
2. Typical value is based on the V_{io} drift observed after 1000h at $125\text{ }^\circ\text{C}$ extrapolated to $25\text{ }^\circ\text{C}$ using the Arrhenius law and assuming an activation energy of 0.7 eV . The operational amplifier is aged in follower mode configuration. See [Chapter 4.4: Long term input offset voltage drift on page 19](#).
3. Guaranteed by design

Figure 2. Supply current vs. supply voltage at $V_{icm} = V_{CC}/2$

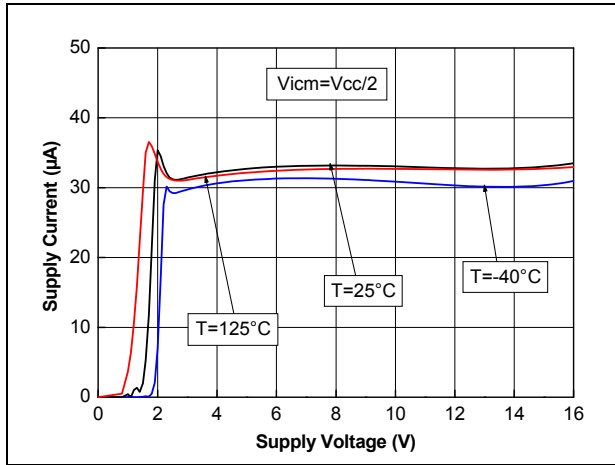

Figure 3. Input offset voltage distribution at $V_{CC} = 16V$

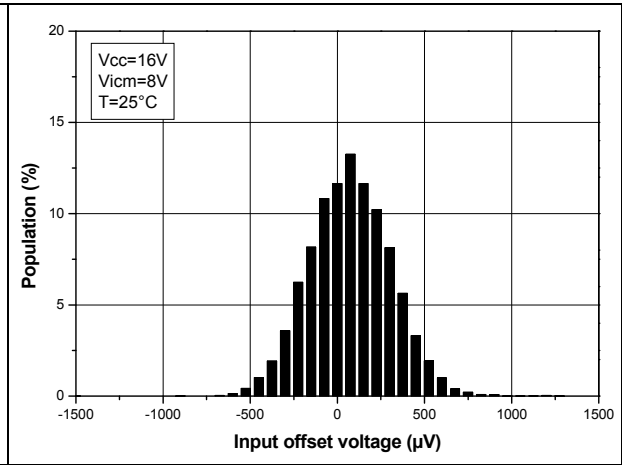

Figure 4. Input offset voltage distribution at $V_{CC} = 10V$

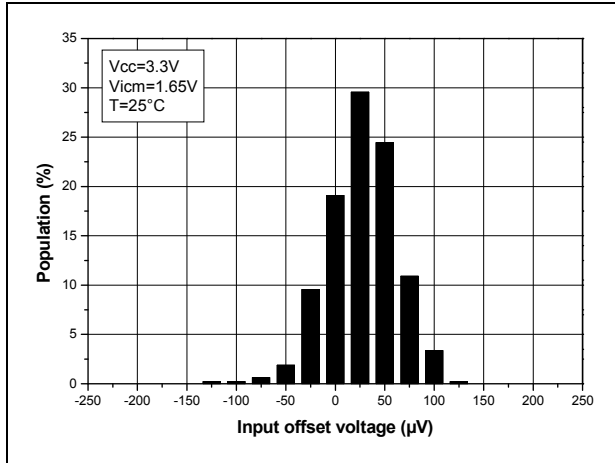

Figure 5. Input offset voltage vs. temperature at $V_{CC} = 16V$

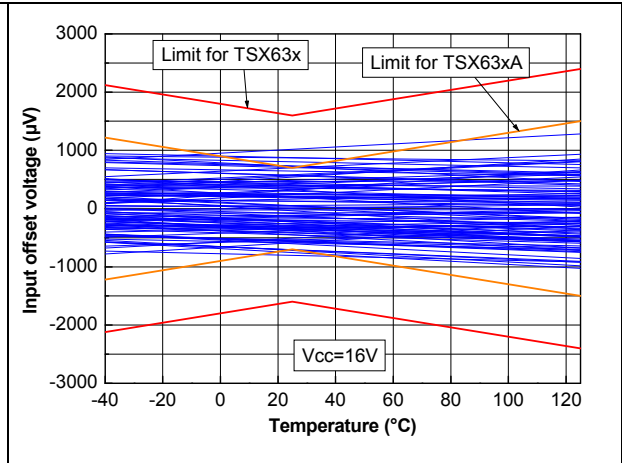

Figure 6. Input offset voltage temperature coefficient distribution

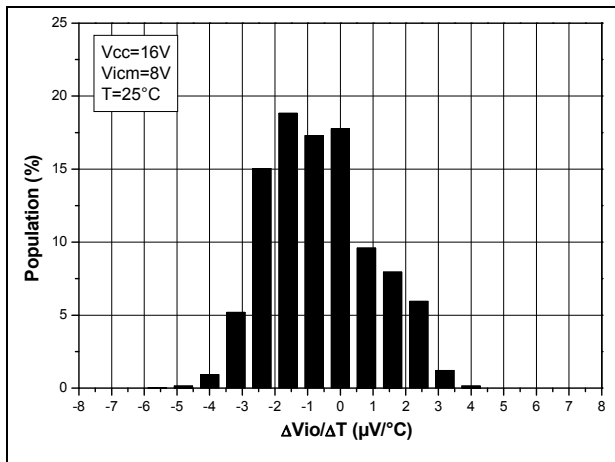

Figure 7. Input offset voltage vs. input common mode voltage

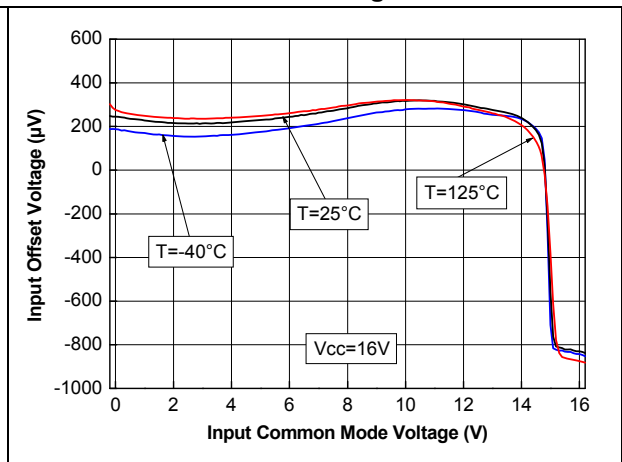

Figure 8. Output current vs. output voltage at $V_{CC} = 3.3\text{ V}$

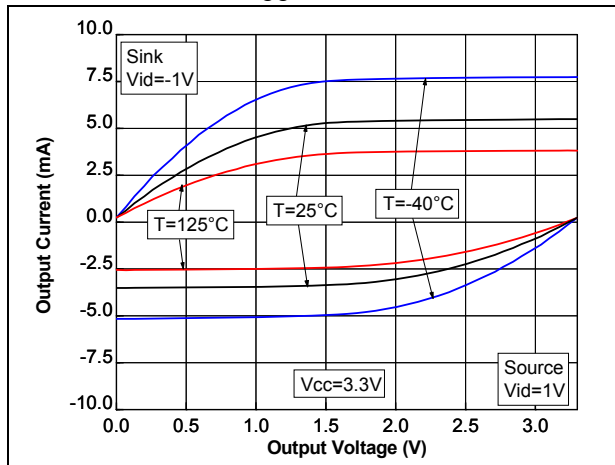

Figure 9. Output current vs. output voltage at $V_{CC} = 16\text{ V}$

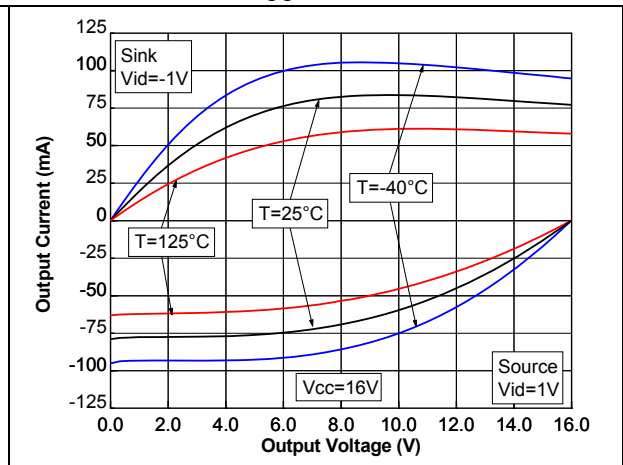

Figure 10. Output low-rail linearity performance ($R_L \geq 2\text{ k}\Omega$)

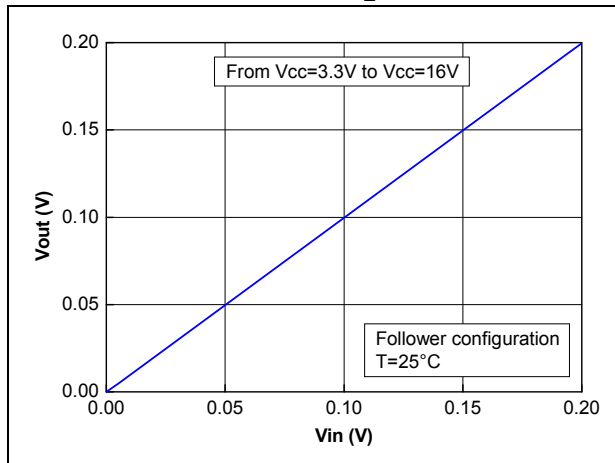

Figure 11. Output high-rail linearity performance ($R_L \geq 2\text{ k}\Omega$)

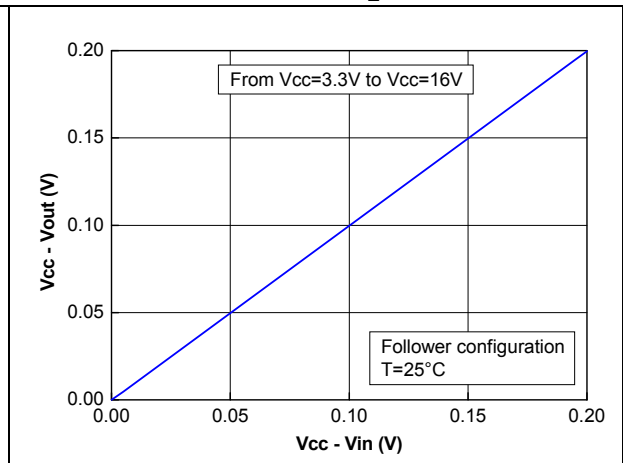

Figure 12. Bode diagram at $V_{CC} = 3.3\text{ V}$, $R_L = 10\text{ k}\Omega$

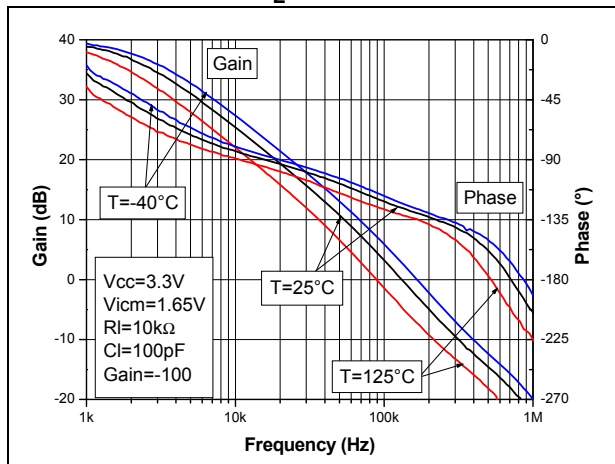

Figure 13. Bode diagram at $V_{CC} = 3.3\text{ V}$, $R_L = 100\text{ k}\Omega$

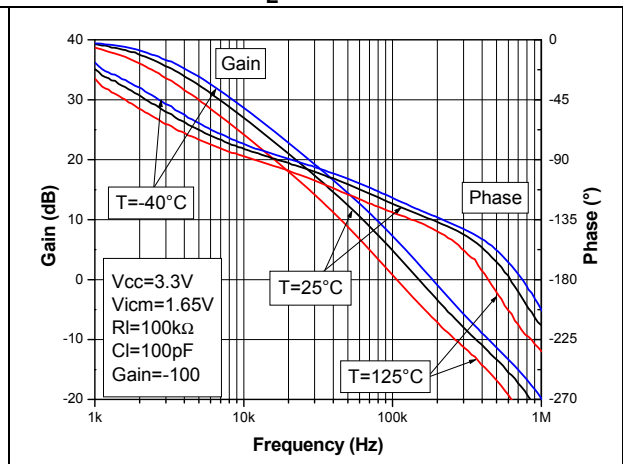

Figure 14. Bode diagram at $V_{CC} = 16\text{ V}$, $R_L = 10\text{ k}\Omega$

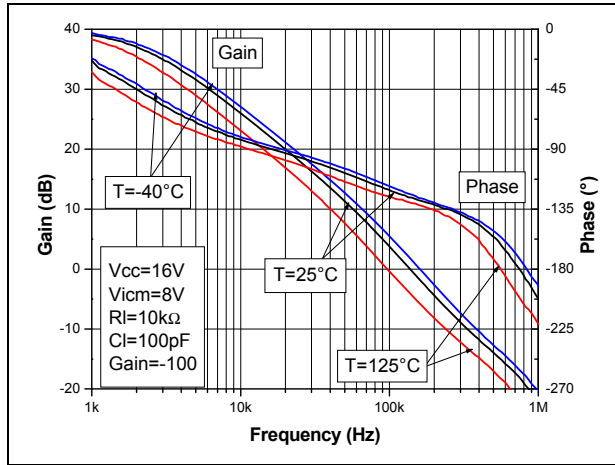

Figure 15. Bode diagram at $V_{CC} = 16\text{ V}$, $R_L = 100\text{ k}\Omega$

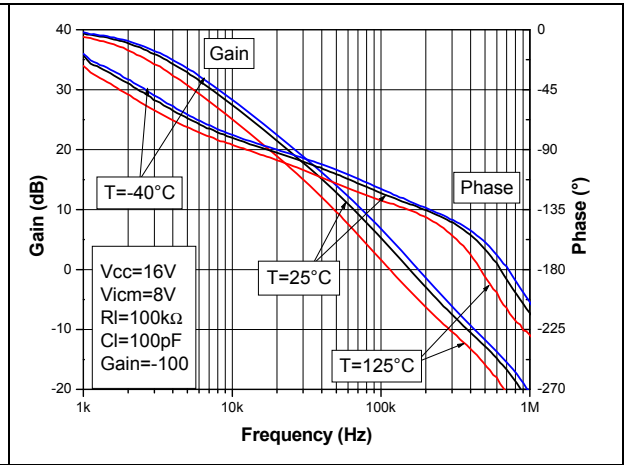

Figure 16. Closed-loop gain vs. capacitive load

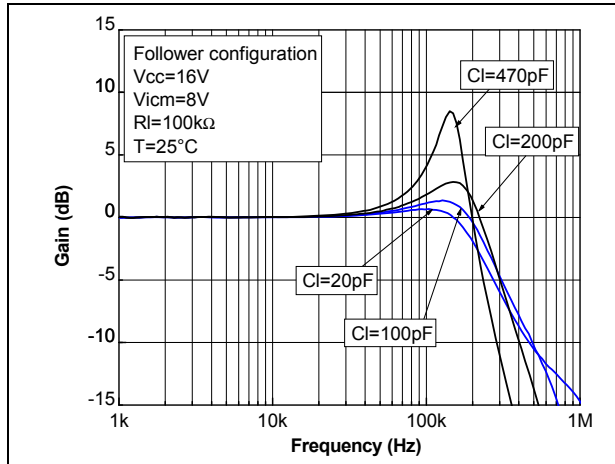

Figure 17. In-series resistor (R_{iso}) vs. capacitive load

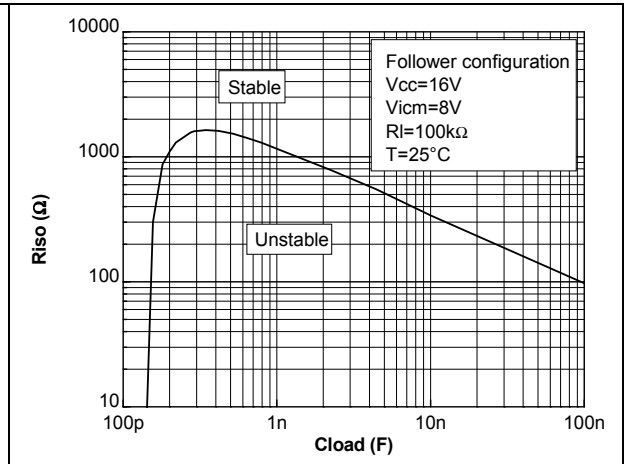

Figure 18. Negative slew rate

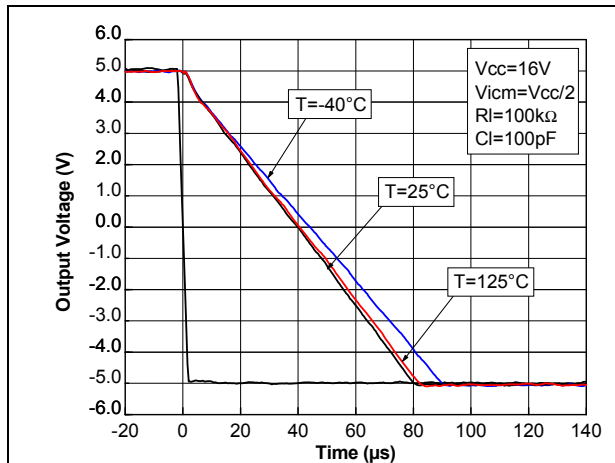

Figure 19. Positive slew rate

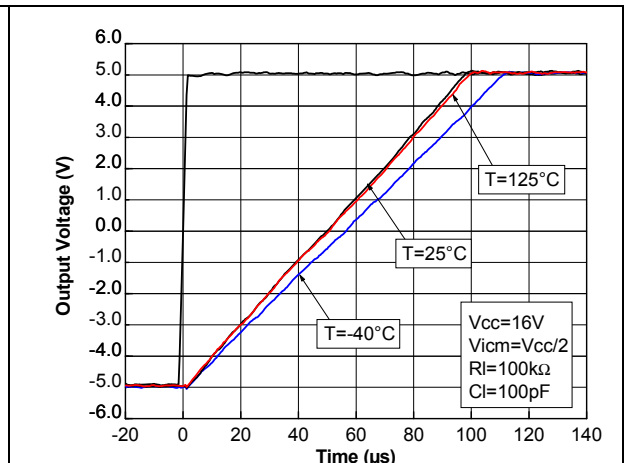

Figure 20. Slew rate vs. supply voltage

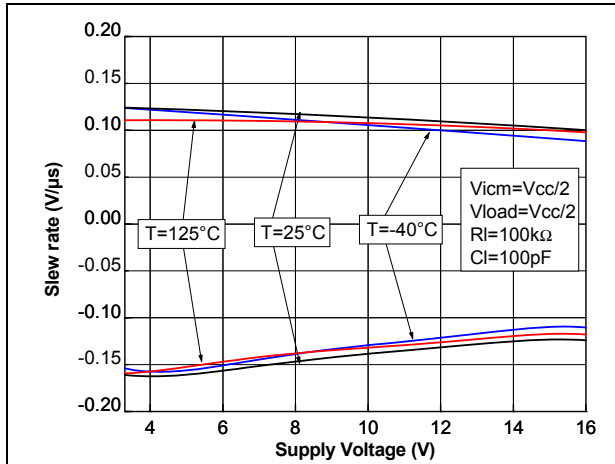

Figure 21. Small step response

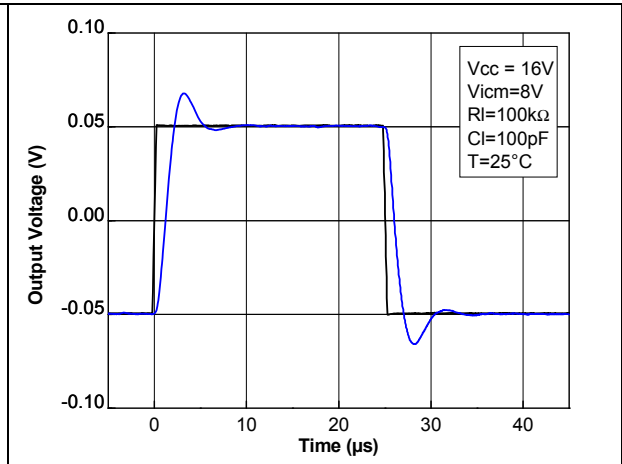

Figure 22. Noise vs. frequency at V_{CC} = 16 V

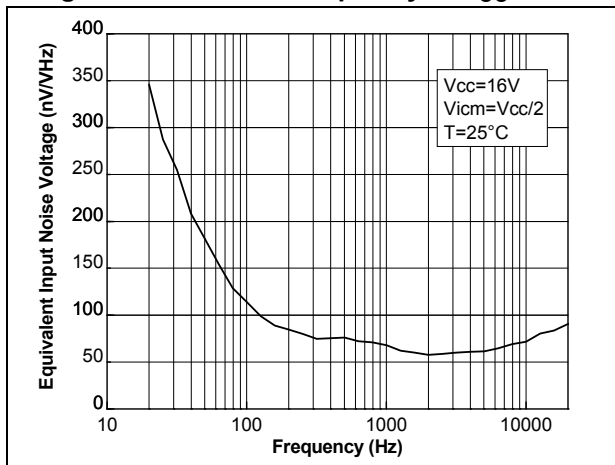

Figure 23. 0.1 Hz to 10 Hz noise at V_{CC} = 16 V

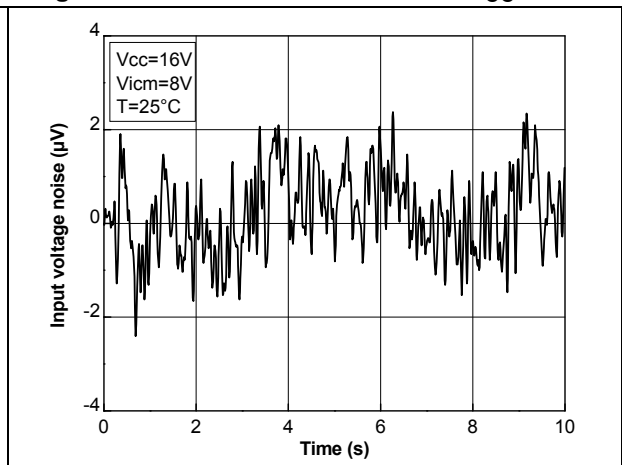

Figure 24. THD+N vs. frequency at V_{CC} = 16 V

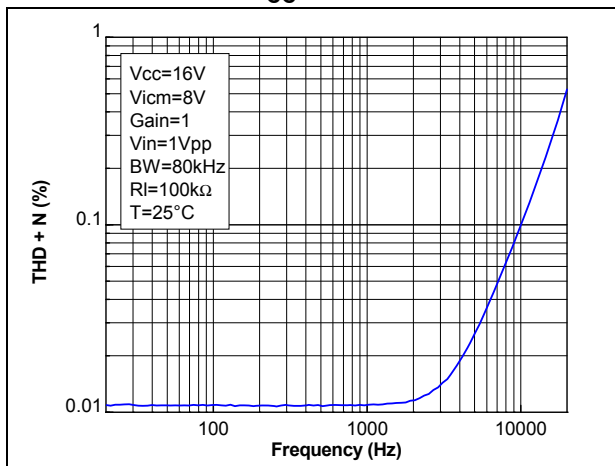

Figure 25. THD+N vs. output voltage at V_{CC} = 16 V

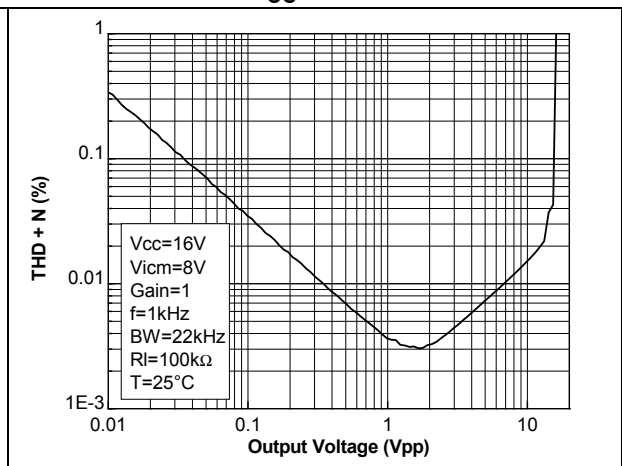

Figure 26. Output impedance vs. frequency in closed loop configuration

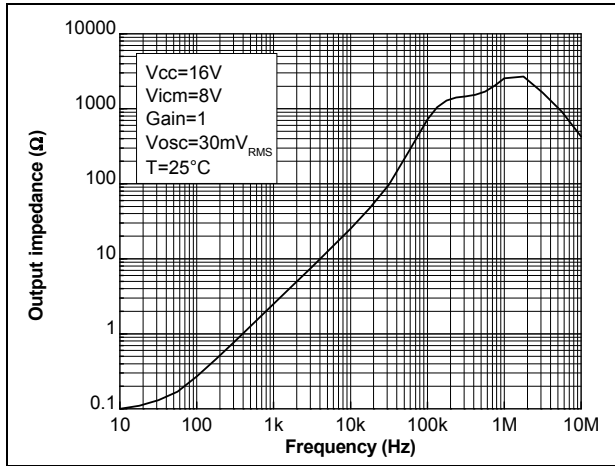
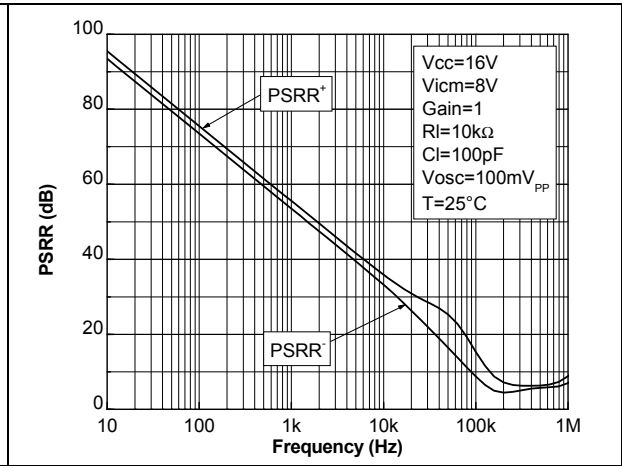

Figure 27. PSRR vs. frequency



4 Application information

4.1 Operating voltages

The amplifiers of the TSX63x and TSX63xA series can operate from 3.3 to 16 V. Their parameters are fully specified at 3.3, 5, 10 and 16 V power supplies. However, the parameters are very stable in the full V_{CC} range. Additionally, the main specifications are guaranteed in extended temperature ranges from $-40\text{ }^{\circ}\text{C}$ to $+125\text{ }^{\circ}\text{C}$.

4.2 Rail-to-rail input

The TSX63x and TSX63xA are built with two complementary PMOS and NMOS input differential pairs. The devices have a rail-to-rail input, and the input common mode range is extended from $V_{CC-} - 0.1\text{ V}$ to $V_{CC+} + 0.1\text{ V}$.

However, the performance of these devices is clearly optimized for the PMOS differential pairs (which means from $V_{CC-} - 0.1\text{V}$ to $V_{CC+} - 1.65\text{V}$).

Beyond $V_{CC+} - 1.65\text{ V}$, the op-amp is still functional but with a degraded performance as can be observed in the electrical characteristics section of this datasheet (mainly V_{io}).

These performances are suitable for a number of applications requiring rail-to-rail input and output.

The devices are guaranteed without phase reversal.

4.3 Input offset voltage drift over temperature

The maximum input voltage drift over the temperature variation is defined as the offset variation related to offset value measured at $25\text{ }^{\circ}\text{C}$. The operational amplifier is one of the main circuits of the signal conditioning chain, and the amplifier input offset is a major contributor to the chain accuracy. The signal chain accuracy at $25\text{ }^{\circ}\text{C}$ can be compensated during production at application level. The maximum input voltage drift over temperature enables the system designer to anticipate the effect of temperature variations.

The maximum input voltage drift over temperature is computed using [Equation 1](#).

Equation 1

$$\frac{\Delta V_{io}}{\Delta T} = \max \left| \frac{V_{io}(T) - V_{io}(25\text{ }^{\circ}\text{C})}{T - 25\text{ }^{\circ}\text{C}} \right|$$

with $T = -40\text{ }^{\circ}\text{C}$ and $125\text{ }^{\circ}\text{C}$.

The datasheet maximum value is guaranteed by a measurement on a representative sample size ensuring a C_{pk} (process capability index) greater than 2.

4.4 Long term input offset voltage drift

To evaluate product reliability, two types of stress acceleration are used:

- Voltage acceleration, by changing the applied voltage
- Temperature acceleration, by changing the die temperature (below the maximum junction temperature allowed by the technology) with the ambient temperature.

The voltage acceleration has been defined based on JEDEC results, and is defined using [Equation 2](#).

Equation 2

$$A_{FV} = e^{\beta \cdot (V_S - V_U)}$$

Where:

A_{FV} is the voltage acceleration factor

β is the voltage acceleration constant in $1/V$, constant technology parameter ($\beta = 1$)

V_S is the stress voltage used for the accelerated test

V_U is the voltage used for the application

The temperature acceleration is driven by the Arrhenius model, and is defined in [Equation 3](#).

Equation 3

$$A_{FT} = e^{\frac{E_a}{k} \cdot \left(\frac{1}{T_U} - \frac{1}{T_S} \right)}$$

Where:

A_{FT} is the temperature acceleration factor

E_a is the activation energy of the technology based on the failure rate

k is the Boltzmann constant ($8.6173 \times 10^{-5} \text{ eV.K}^{-1}$)

T_U is the temperature of the die when V_U is used (K)

T_S is the temperature of the die under temperature stress (K)

The final acceleration factor, A_F , is the multiplication of the voltage acceleration factor and the temperature acceleration factor ([Equation 4](#)).

Equation 4

$$A_F = A_{FT} \times A_{FV}$$

A_F is calculated using the temperature and voltage defined in the mission profile of the product. The A_F value can then be used in [Equation 5](#) to calculate the number of months of use equivalent to 1000 hours of reliable stress duration.

Equation 5

$$\text{Months} = A_F \times 1000 \text{ h} \times 12 \text{ months} / (24 \text{ h} \times 365.25 \text{ days})$$

To evaluate the op-amp reliability, a follower stress condition is used where V_{CC} is defined as a function of the maximum operating voltage and the absolute maximum rating (as recommended by JEDEC rules).

The V_{io} drift (in μV) of the product after 1000 h of stress is tracked with parameters at different measurement conditions (see [Equation 6](#)).

Equation 6

$$V_{CC} = \max V_{op} \text{ with } V_{icm} = V_{CC} / 2$$

The long term drift parameter (ΔV_{io}), estimating the reliability performance of the product, is obtained using the ratio of the V_{io} (input offset voltage value) drift over the square root of the calculated number of months ([Equation 7](#)).

Equation 7

$$\Delta V_{io} = \frac{V_{io} \text{ drift}}{\sqrt{(\text{months})}}$$

where V_{io} drift is the measured drift value in the specified test conditions after 1000 h stress duration.

4.5 High values of input differential voltage

In closed loop configuration, which represents the typical use of an op-amp, the input differential voltage is low (close to V_{io}). However, some specific conditions can lead to higher input differential values, such as:

- operation in an output saturation state
- operation at speeds higher than the device bandwidth, with output voltage dynamics limited by slew rate.
- use of the amplifier in a comparator configuration, hence in open loop

Use of the TSX631 in comparator configuration, especially combined with high temperature and long duration can create a permanent drift of V_{io} .

All channels of the dual and quad versions of the TSX632 and TSX634 are virtually unaffected when used in comparator configuration.

4.6 PCB layouts

For correct operation, it is advised to add 10 nF decoupling capacitors as close as possible to the power supply pins.

4.7 Macromodel

Accurate macromodels of the TSX63x and TSX63xA are available on STMicroelectronics' web site at www.st.com. These models are a trade-off between accuracy and complexity (that is, time simulation) of the TSX63x and TSX63xA operational amplifiers. They emulate the nominal performances of a typical device within the specified operating conditions mentioned in the datasheet. They also help to validate a design approach and to select the right operational amplifier, *but they do not replace on-board measurements*.

5 Package information

In order to meet environmental requirements, ST offers these devices in different grades of ECOPACK[®] packages, depending on their level of environmental compliance. ECOPACK[®] specifications, grade definitions and product status are available at: www.st.com. ECOPACK[®] is an ST trademark.

5.1 SOT23-5 package information

Figure 28. SOT23-5 package mechanical drawing

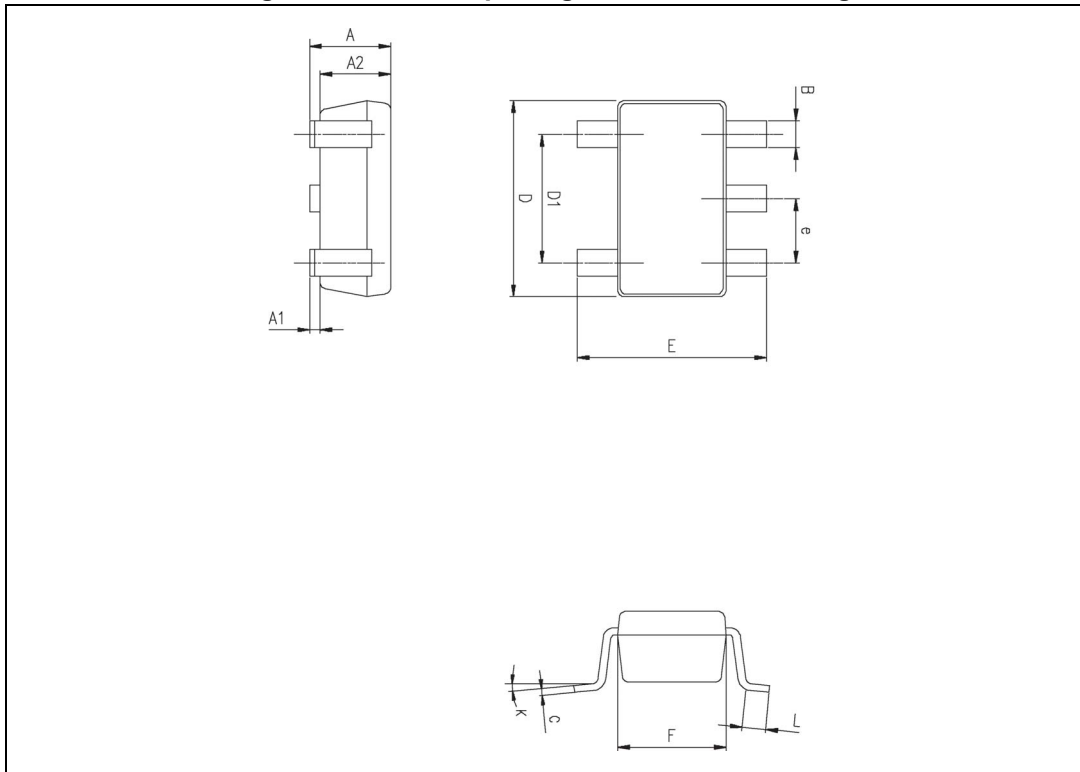

Table 8. SOT23-5 package mechanical data

Ref.	Dimensions					
	Millimeters			Inches		
	Min.	Typ.	Max.	Min.	Typ.	Max.
A	0.90	1.20	1.45	0.035	0.047	0.057
A1			0.15			0.006
A2	0.90	1.05	1.30	0.035	0.041	0.051
B	0.35	0.40	0.50	0.013	0.015	0.019
C	0.09	0.15	0.20	0.003	0.006	0.008
D	2.80	2.90	3.00	0.110	0.114	0.118
D1		1.90			0.075	
e		0.95			0.037	
E	2.60	2.80	3.00	0.102	0.110	0.118
F	1.50	1.60	1.75	0.059	0.063	0.069
L	0.10	0.35	0.60	0.004	0.013	0.023
K	0 °		10 °	0 °		10 °

5.2 DFN8 2x2 package information

Figure 29. DFN8 2x2 package mechanical drawing

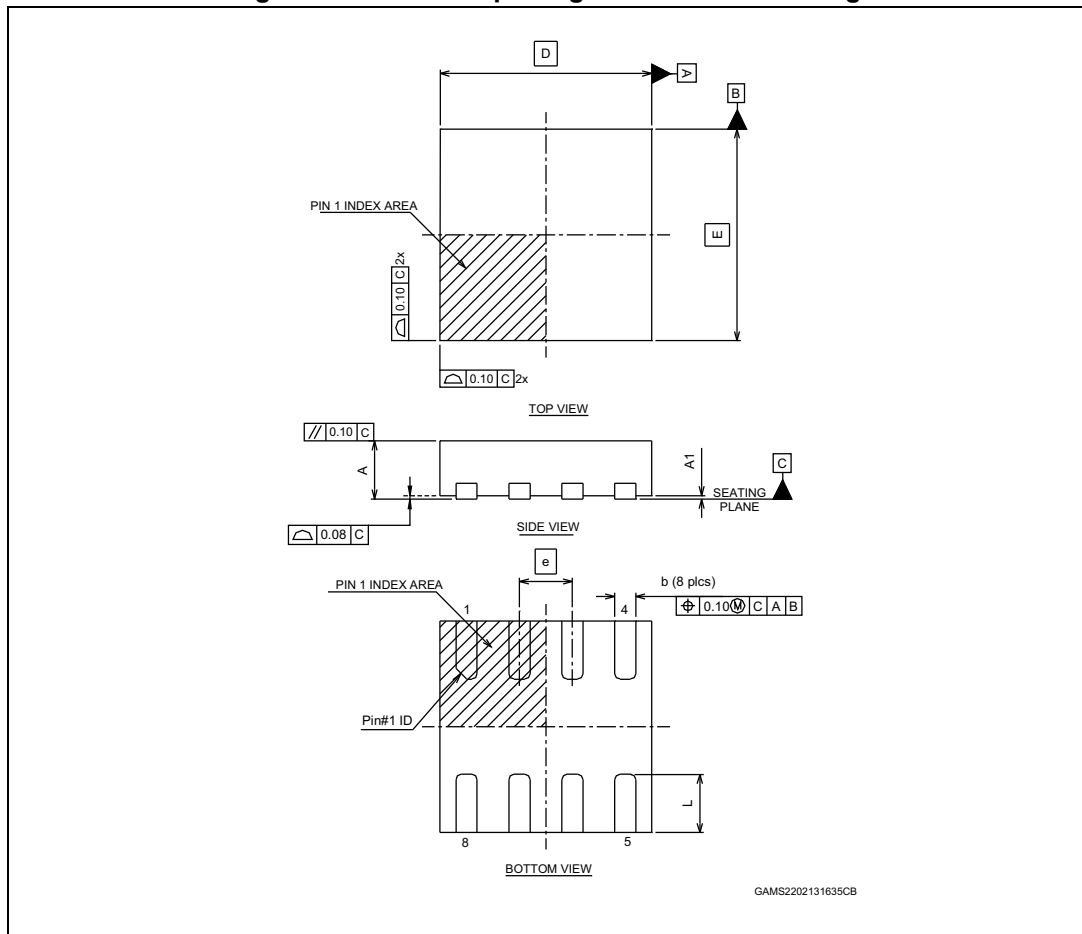

Table 9. DFN8 2x2 package mechanical data

Ref.	Dimensions					
	Millimeters			Inches		
	Min.	Typ.	Max.	Min.	Typ.	Max.
A	0.70	0.75	0.80	0.028	0.030	0.031
A1	0.00	0.02	0.05	0.000	0.001	0.002
b	0.15	0.20	0.25	0.006	0.008	0.010
D		2.00			0.079	
E		2.00			0.079	
e		0.50			0.020	
L	0.045	0.55	0.65	0.018	0.022	0.026
N	8			8		

5.3 MiniSO-8 package information

Figure 30. MiniSO-8 package mechanical drawing

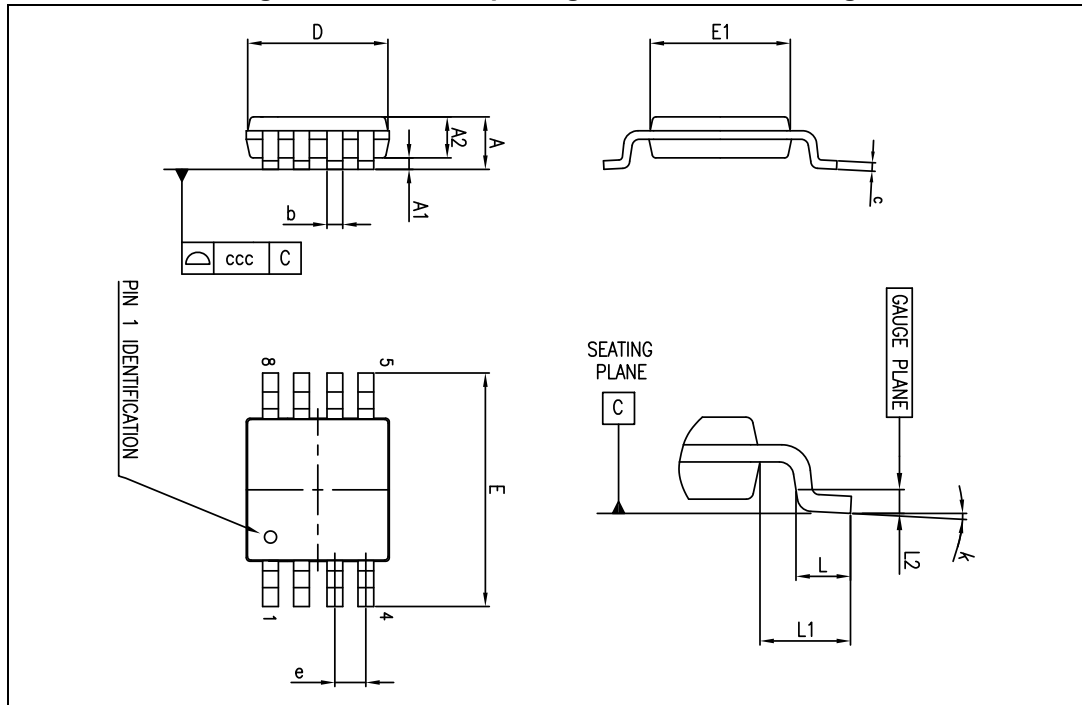

Table 10. MiniSO-8 package mechanical data

Ref.	Dimensions					
	Millimeters			Inches		
	Min.	Typ.	Max.	Min.	Typ.	Max.
A			1.1			0.043
A1	0		0.15	0		0.006
A2	0.75	0.85	0.95	0.030	0.033	0.037
b	0.22		0.40	0.009		0.016
c	0.08		0.23	0.003		0.009
D	2.80	3.00	3.20	0.11	0.118	0.126
E	4.65	4.90	5.15	0.183	0.193	0.203
E1	2.80	3.00	3.10	0.11	0.118	0.122
e		0.65			0.026	
L	0.40	0.60	0.80	0.016	0.024	0.031
L1		0.95			0.037	
L2		0.25			0.010	
k	0°		8°	0°		8°
ccc			0.10			0.004

5.4 QFN16 3x3 package information

Figure 31. QFN16 3x3 package mechanical drawing

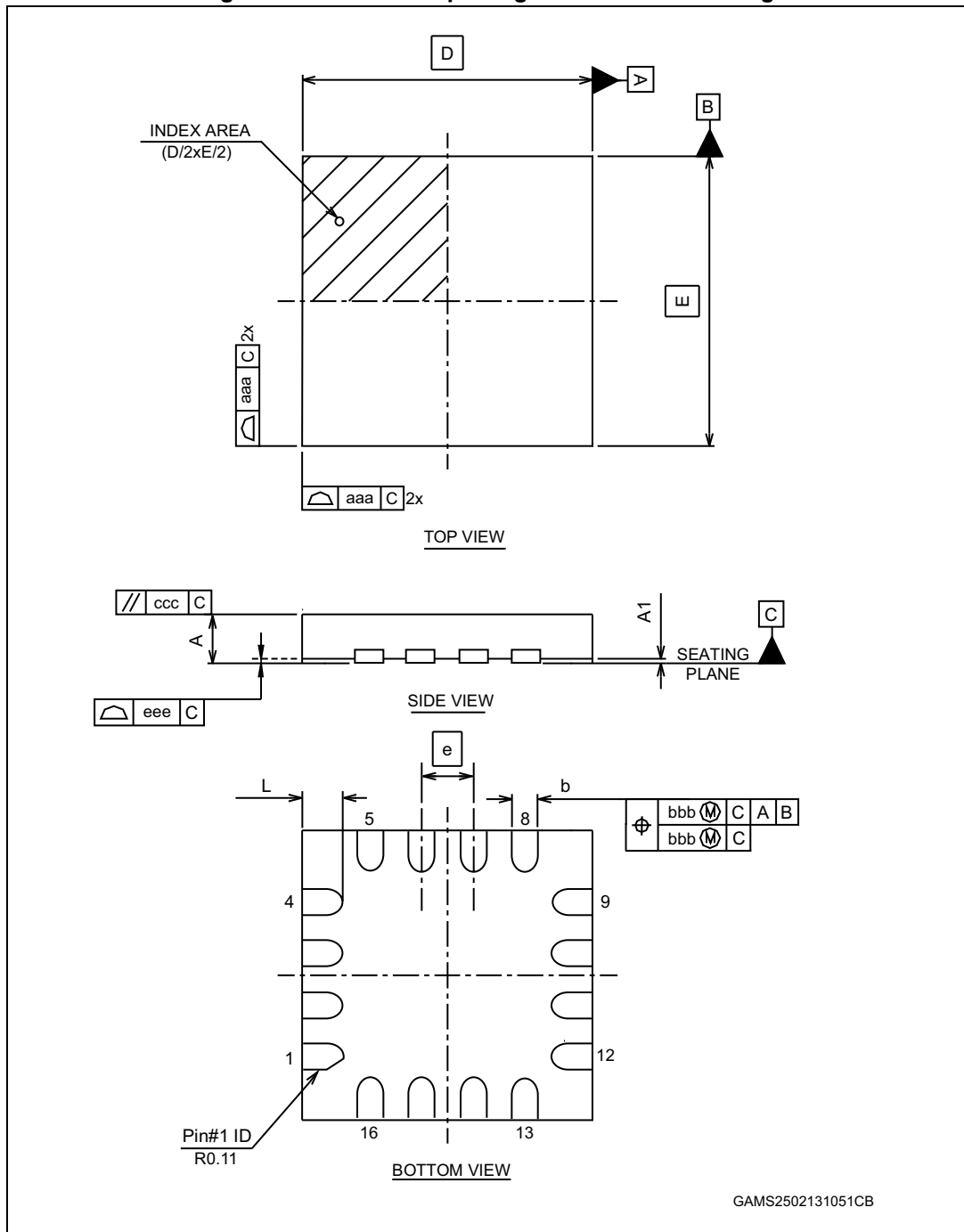

Table 11. QFN16 3x3 package mechanical data

Ref.	Dimensions					
	Millimeters			Inches		
	Min.	Typ.	Max.	Min.	Typ.	Max.
A	0.50		0.65	0.020		0.026
A1	0		0.05	0		0.002
b	0.18	0.25	0.30	0.007	0.010	0.012
D		3.00			0.118	
E		3.00			0.118	
e		0.50			0.020	
L	0.30		0.50	0.012		0.020
aaa			0.15			0.006
bbb			0.10			0.004
ccc			0.10			0.004
ddd			0.05			0.002
eee			0.08			0.003

5.5 TSSOP14 package information

Figure 32. TSSOP14 package mechanical drawing

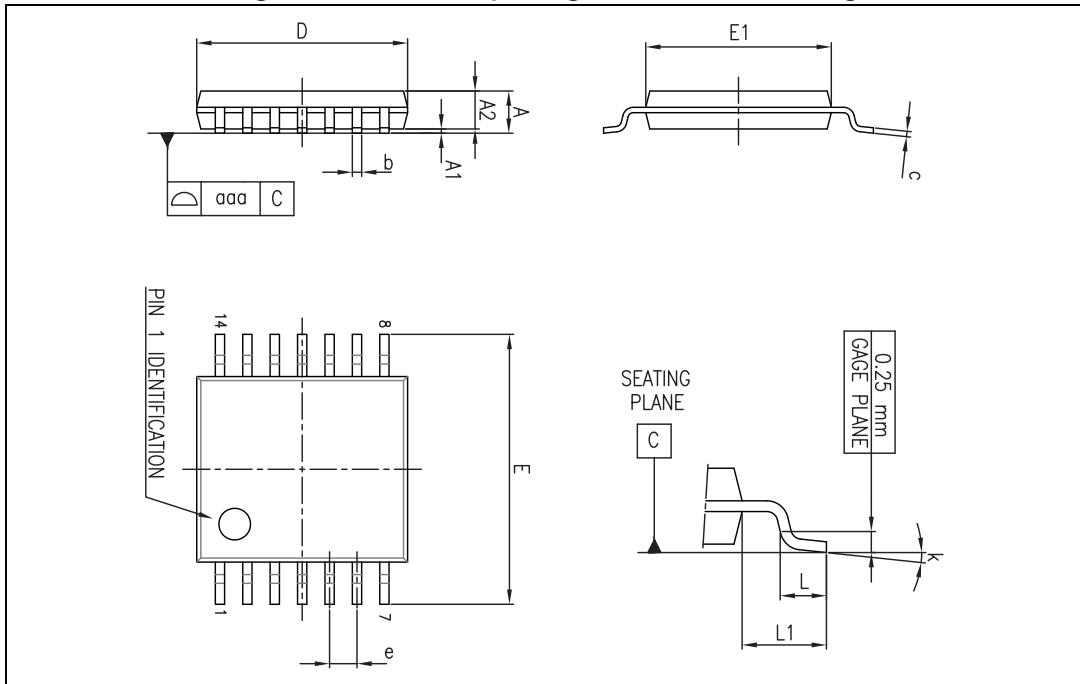

Table 12. TSSOP14 package mechanical data

Ref.	Dimensions					
	Millimeters			Inches		
	Min.	Typ.	Max.	Min.	Typ.	Max.
A			1.20			0.047
A1	0.05		0.15	0.002	0.004	0.006
A2	0.80	1.00	1.05	0.031	0.039	0.041
b	0.19		0.30	0.007		0.012
c	0.09		0.20	0.004		0.0089
D	4.90	5.00	5.10	0.193	0.197	0.201
E	6.20	6.40	6.60	0.244	0.252	0.260
E1	4.30	4.40	4.50	0.169	0.173	0.176
e		0.65			0.0256	
L	0.45	0.60	0.75	0.018	0.024	0.030
L1		1.00			0.039	
k	0°		8°	0°		8°
aaa			0.10			0.004

6 Ordering information

Table 13. Order codes

Order code	Temperature range	No. of channels	Package	Packing	Marking
TSX631ILT	-40 to 125 °C	1	SOT23-5	Tape and reel	K27
TSX632IQ2T		2	DFN8 2x2		K27
TSX632IST		2	MiniSO8		K27
TSX634IQ4T		4	QFN16 3x3		K27
TSX634IPT		4	TSSOP14		TSX634I
TSX631IYLT	-40 to 125 °C Automotive grade ⁽¹⁾	1	SOT23-5		K188
TSX632IYST		2	MiniSO8		K188
TSX634IYPT		4	TSSOP14		TSX634IY
TSX631AILT	-40 to 125 °C	1	SOT23-5		K189
TSX632AIST		2	MiniSO8		K189
TSX634AIPT		4	TSSOP14		TSX634AI
TSX631AIYLT	-40 to 125°C Automotive grade ⁽¹⁾	1	SOT23-5		K190
TSX632AIYST		2	MiniSO8		K190
TSX634AIYPT		4	TSSOP14		TSX634AIY

1. Qualification and characterization according to AEC Q100 and Q003 or equivalent, advanced screening according to AEC Q001 & Q 002 or equivalent are on-going.

7 Revision history

Table 14. Document revision history

Date	Revision	Changes
26-Mar-2013	1	Initial release